

User Manual

SV-iH

AC Drives

30-55kW (200V) / 30-220kW (400V)



Safety Instructions

- Read this manual carefully before installing, wiring, operating, servicing or inspecting the drive.
- Keep this manual within easy reach for quick reference.

Thank you for purchasing LS Variable Frequency Drive!

SAFETY INSTRUCTIONS

- Always follow safety instructions to prevent accidents and potential hazards from occurring.
- In this manual, safety messages are classified as follows:



WARNING

Improper operation may result in serious personal injury or death.



CAUTION

Improper operation may result in slight to medium personal injury or property damage.

- Throughout this manual we use the following two illustrations to make you aware of safety considerations:



Identifies potential hazards under certain conditions.
Read the message and follow the instructions carefully.



Identifies shock hazards under certain conditions.
Particular attention should be directed because dangerous voltage may exist.

- Keep operating instructions handy for quick reference.
- Read this manual carefully to maximize the performance of SV-iH series inverter and ensure its safe use.



WARNING

- **Do not remove the cover while power is applied or the unit is in operation.**
Otherwise, electric shock could occur.
- **Do not run the inverter with the front cover removed.**
Otherwise, you may get an electric shock due to high voltage terminals or charged capacitor exposure.
- **Do not remove the cover except for periodic inspections or wiring, even if the input power is not applied.**
Otherwise, you may access the charged circuits and get an electric shock.
- **Wiring and periodic inspections should be performed at least 10 minutes after disconnecting the input power and after checking the DC link voltage is discharged with a meter (below DC 30V).**
Otherwise, you may get an electric shock.

- **Operate the switches with dry hands.**
Otherwise, you may get an electric shock.
- **Do not use the cable when its insulating tube is damaged.**
Otherwise, you may get an electric shock.
- **Do not subject the cables to scratches, excessive stress, heavy loads or pinching.**
Otherwise, you may get an electric shock.



CAUTION

- **Install the inverter on a non-flammable surface. Do not place flammable material nearby.**
Otherwise, fire could occur.
- **Disconnect the input power if the inverter gets damaged.**
Otherwise, it could result in a secondary accident and fire.
- **Do not connect the braking resistor directly to the DC terminals between P1 (P2) and N or P1 and P2.**
Otherwise, fire could occur.
- **After the input power is applied or removed, the inverter will remain hot for a couple of minutes.**
Otherwise, you may get bodily injuries such as skin-burn or damage.
- **Do not apply power to a damaged inverter or to an inverter with parts missing even if the installation is complete.**
Otherwise, electric shock could occur.
- **Do not allow lint, paper, wood chips, dust, metallic chips or other foreign matter into the drive.**
Otherwise, fire or accident could occur.
- **Use hoist or crane for moving and installing iH inverters.**
Otherwise, it may cause bodily injury due to its heavy weight.

OPERATING PRECAUTIONS

(1) Handling and installation

- Handle according to the weight of the product.
- Do not stack the inverter boxes higher than the number recommended.
- Install according to instructions specified in this manual.
- Do not open the cover during delivery.
- Do not place heavy items on the inverter.
- Check the inverter mounting orientation is correct.
- Do not drop the inverter, or subject it to impact.
- For grounding, grounding impedance is 100ohm or less for 200V class and 10 ohm or less for 400 V class inverter.
- Take protective measures against ESD (Electrostatic Discharge) before touching the pcb for inspection or installation.

(2) Wiring

- Do not connect a power factor correction capacitor, surge suppressor, or RFI filter to the output of the inverter.
- The connection orientation of the output cables U, V, W to the motor will affect the direction of rotation of the motor.
- Incorrect terminal wiring could result in the equipment damage.
- Reversing the polarity (+/-) of the terminals could damage the inverter.
- Only authorized personnel familiar with LS inverter should perform wiring and inspections.
- Always install the inverter before wiring. Otherwise, you may get an electric shock or have bodily injury.

(3) Trial run

- Check all parameters during operation. Changing parameter values might be required depending on the load.
- Always apply permissible range of voltage to the each terminal as indicated in this manual. Otherwise, it could lead to inverter damage.

(4) Operation precautions

- When the Auto restart function is selected, stay away from the equipment as a motor will restart suddenly after an alarm stop.
- The Stop key on the keypad is valid only when the appropriate function setting has been made. Prepare an emergency stop switch separately.
- If an alarm reset is made with the reference signal present, a sudden start will occur. Check that the reference signal is turned off in advance. Otherwise an accident could occur.
- Do not modify or alter anything inside the inverter.
- Motor might not be protected by electronic thermal function of inverter.

- Do not use a magnetic contactor on the inverter input for frequent starting/stopping of the inverter.
- Use a noise filter to reduce the effect of electromagnetic interference. Otherwise nearby electronic equipment may be affected.
- In case of input voltage unbalance, install AC reactor. Power Factor capacitors and generators may become overheated and damaged due to potential high frequency noise transmitted from inverter.
- Use an insulation-rectified motor or take measures to suppress the micro surge voltage when driving 400V class motor with inverter. A micro surge voltage attributable to wiring constant is generated at motor terminals, and may deteriorate insulation and damage motor.
- Before operating unit and prior to user programming, reset user parameters to default settings.
- Inverter can easily be set to high-speed operations, Verify capability of motor or machinery prior to operating unit.
- Stopping torque is not produced when using the DC-Break function. Install separate equipment when stopping torque is needed.

(5) Fault prevention precautions

- Provide a safety backup such as an emergency brake which will prevent the machine and equipment from hazardous conditions if the inverter fails.

(6) Maintenance, inspection and parts replacement

- Do not conduct a megger (insulation resistance) test on the control circuit of the inverter.
- Refer to Chapter 6 for periodic inspection (parts replacement).

(7) Disposal

- Handle the inverter as an industrial waste when disposing of it.

(8) General instructions

- Many of the diagrams and drawings in this instruction manual show the inverter without a circuit breaker, a cover or partially open. Never run the inverter like this. Always place the cover with circuit breakers and follow this instruction manual when operating the inverter.

Table of Contents

USER SELECTION GUIDE (iH SPECIFICATIONS)	6
CHAPTER 1 - INSTALLATION	9
1.1 Inspection.....	9
1.2 Environmental Conditions	9
1.3 Mounting	9
1.4 Other Precautions	10
1.5 Dimensions	11
1.6 Basic Wiring	14
1.7 Power Terminals	15
1.8 Control Terminals.....	20
CHAPTER 2 - OPERATION	22
2.1 Parameter Groups	22
2.2 Display	23
2.3 Alpha-numerical Display	23
2.4 Procedure of Setting Data.....	24
2.5 Parameter Navigation	25
2.6 Operation Method	26
CHAPTER 3 - QUICK- START PROCEDURES	27
3.1 Operation Using Keypad.....	28
3.2 Operation Using Control Terminal – External Start, Stop and Speed Reference	30
3.3 Operation Using Both Keypad and Control Terminals	32
CHAPTER 4 - PARAMETER LIST	35
4.1 Drive Group.....	35
4.2 Function Group	35
4.3 I/O Group	39
CHAPTER 5 - PARAMETER DESCRIPTION	43
5.1 Drive Group [DRV].....	43
5.2 Function Group	45
5.3 I/O Group	65
CHAPTER 6 - TROUBLESHOOTING & MAINTENANCE	79
6.1 Fault Display	79
6.2 Fault Remedy.....	80
6.3 Troubleshooting	81
6.4 How to Check Power Components	86
6.5 Maintenance	87
6.6 Daily and Periodic Inspection Items.....	88
APPENDIX A - FUNCTIONS BASED ON USE	89
APPENDIX B - PARAMETERS BASED ON APPLICATION	90
DECLARATION OF CONFORMITY	91

USER SELECTION GUIDE (iH SPECIFICATIONS)

200~230V Class (40 - 75HP)

Model Number		SV030iH-2U	SV037iH-2U	SV045iH-2U	SV055iH-2U
Motor Rating ¹	Constant Torque [HP]	40	50	60	75
	Constant Torque [kW]	30	37	45	55
Output Ratings	Constant Torque [kVA] ²	46	55	68	83
	Constant Torque FLA [A]	122	146	180	220
Input Ratings	Input Voltage	3 Phase, 200 to 230 V (± 10%)			
	Input Frequency	50 to 60 Hz (± 5%)			
Weight [kg (lbs)]		42 (93)	42 (93)	56 (123)	56 (123)

380~400V Class (40 - 100HP)

Model Number		SV030iH-4U	SV037iH-4U	SV045iH-4U	SV055iH-4U	SV075iH-4U
Motor Rating ¹	Constant Torque [HP]	40	50	60	75	100
	Constant Torque [kW]	30	37	45	55	75
	Variable Torque [HP]	50	60	75	100	125
	Variable Torque [kW]	37	45	55	75	90
Output Ratings	Constant Torque FLA [A]	61	75	91	110	152
	Constant Torque [kVA] ³	40	50	60	70	100
	Variable Torque FLA [A]	80	96	115	125	160
	Variable Torque [kVA] ³	52	62	74	80	103
Input Ratings	Input Voltage	3 Phase, 380 to 400 V (± 10%)				
	Input Frequency	50 to 60 Hz (± 5%)				
Weight [kg (lbs)]		45 (99)	45 (99)	63 (139)	63 (139)	68 (150)

380~400V Class (125 - 300HP)

Model Number		SV090iH-4U	SV110iH-4U	SV132iH-4U	SV160iH-4U	SV220iH-4U
Motor Rating ¹	Constant Torque [HP]	125	150	175	215	300
	Constant Torque [kW]	90	110	132	160	220
	Variable Torque [HP]	150	175	215	250	350
	Variable Torque [kW]	110	132	160	185	280
Output Ratings	Constant Torque FLA [A]	183	223	264	325	432
	Constant Torque [kVA] ³	120	145	170	200	280
	Variable Torque FLA [A]	228	264	330	361	477
	Variable Torque [kVA] ³	147	170	213	233	307
Input Ratings	Input Voltage	3 Phase, 380 to 400 V (± 10%)				
	Input Frequency	50 to 60 Hz (± 5%)				
Weight [kg (lbs)]		98 (216)	98 (216)	122 (269)	122 (269)	175 (386)

¹ Indicates the maximum applicable capacity when using a 4 Pole motor.

² Rated kVA ($\sqrt{3} \cdot V \cdot I$) listed is based on 220VAC operation.

³ Rated kVA ($\sqrt{3} \cdot V \cdot I$) listed is based on 380VAC operation.

440~460V Class (40 - 100HP)

Model Number		SV030iH-4U	SV037iH-4U	SV045iH-4U	SV055iH-4U	SV075iH-4U
Motor Rating ⁴	Constant Torque [HP]	40	50	60	75	100
	Constant Torque [kW]	30	37	45	55	75
	Variable Torque [HP]	50	60	75	100	125
	Variable Torque [kW]	37	45	55	75	90
Output Ratings	Constant Torque FLA [A]	61	75	91	110	152
	Constant Torque [kVA] ⁵	45	56	68	82	113
	Variable Torque FLA [A]	80	96	115	125	160
	Variable Torque [kVA] ⁵	60	70	86	93	120
Input Ratings	Input Voltage	3 Phase, 440 to 460 V (± 10%)				
	Input Frequency	50 to 60 Hz (± 5%)				
Weight [kg (lbs)]		45 (99)	45 (99)	63 (139)	63 (139)	68 (150)

440~460V Class (125 - 300HP)

Model Number		SV090iH-4U	SV110iH-4U	SV132iH-4U	SV160iH-4U	SV220iH-4U
Motor Rating ⁴	Constant Torque [HP]	125	150	200	250	300
	Constant Torque [kW]	90	110	132	160	220
	Variable Torque [HP]	150	200	250	300	350
	Variable Torque [kW]	110	132	185	220	280
Output Ratings	Constant Torque FLA [A]	183	223	264	325	432
	Constant Torque [kVA] ⁵	136	166	197	242	322
	Variable Torque FLA [A]	228	264	330	361	477
	Variable Torque [kVA] ⁵	170	200	246	270	356
Input Ratings	Input Voltage	3 Phase, 440 to 460 V (± 10%)				
	Input Frequency	50 to 60 Hz (± 5%)				
Weight [kg (lbs)]		98 (216)	98 (216)	122 (269)	122 (269)	175 (386)

⁴ Indicates the maximum applicable capacity when using a 4 Pole motor.

⁵ Rated kVA ($\sqrt{3 \cdot V \cdot I}$) listed is based on 440VAC operation.

All Models

Output Ratings	Max. Frequency	0.5 to 400 Hz
	Output Voltage	3 Phase, 0 to Input Voltage
Control	Control Method	Space Vector PWM
	Frequency Setting Resolution	Digital Reference: 0.01 Hz (Below 100Hz), 0.1 Hz (Over 100Hz) Analog Reference: 0.03 Hz / 60Hz
	Frequency Accuracy	Digital: 0.01% of Maximum Output Frequency Analog: 0.1% of Maximum Output Frequency
	V/F Ratio	Linear, Non-Linear, User Programmable
	Braking Torque (w/o DB)	About 20%
	Overload Capacity CT	150% of Rated Current for 1 Minute, 200% for 0.5 Second
	Overload Capacity VT	110% of Rated Current for 1 Minute, 150% for 0.5 Second
	Torque Boost	Manual Torque Boost (0 to 20%), Auto Torque Boost
Operating	Operation Method	Keypad / Terminal / Remote (Optional)
	Frequency Setting	Analog: 0 to 10 V / 4 to 20mA, Digital: Keypad
	Accel / Decel Time	0.1 to 6,000 sec, 8 Pre-Defined (Programmable)
	Multi-Step	8 Preset Operational Speed
	Jog	Jog Operation
	Operating Function	DC Braking, Frequency Limit, Frequency Jump, Slip Compensation, PI Control, Stall Prevention
	Operating Status	Frequency Detection Level, Overload Alarm, Stalling, Over Voltage, Under Voltage, Inverter Overheat, Run, Stop, Constant Speed, Speed Searching
	Start Signal	Forward, Reverse
Programmable I/O	Programmable Input	6 Programmable Inputs
	Programmable Output	5 Programmable Outputs: 2 Form A Contact (N.O.) Fault Contact Output (A, C, B) – 250VAC 1A, 30VDC 1A 3 Open Collector Outputs: 24V, 50mA
	Analog	4 ~ 20mA
	Meter	RPM, Hz, Current, Voltage (Output Pulse: 500Hz, Output Voltage: 0 ~ 10V)
Protective Functions	Inverter Trip	Over Voltage, Under Voltage, Over Current, Inverter Overload, Fuse Open, Ground Fault, Inverter Overheat, Motor Overheat, Main CPU Error.
	Stall Prevention	Over Current Prevention
	Instant Power Loss	Less Than 15msec: Continuous Operation More Than 15msec: Auto Restart (Programmable)
Operating Conditions	Ambient Temp.	<i>UL Listing: Surrounding Air Ambient Rating 14 °F ~ 113 °F (-10 °C ~ 45 °C Max.), CE Certification: 41 °F ~ 104 °F (5 °C ~ 40 °C)</i>
	Storage Temp.	-4 °F ~ 149 °F (-20 °C ~ 65 °C)
	Humidity	90% RH Max. (Non-Condensing), <i>CE Certification: 5 ~85% (Non-Condensing)</i>
	Altitude / Vibration	Below 3,300ft (1,000m) / Below 5.9m/sec ² (0.6g)
	Air Pressure	86 ~ 106kPa
	Application Site	No Corrosive Gas, Combustible Gas, Oil Mist, or Dust
	Cooling Method	Forced Air Cooling
Enclosure	IP00	
Inter National Standards	CE Certified, UL Listed (UL508C) ⁶	

⁶ UL508C: UL Standard for Safety for Power Conversion Equipment. UL File E124949. UL listing is available only for 380-460V Class drives.

CHAPTER 1 - INSTALLATION

1.1 Inspection

- ✓ Inspect the inverter for any damage that may have occurred during shipping.
- ✓ Check the nameplate on the inverter. Verify the inverter unit is the correct one for the application. The numbering system for the inverter is as shown below.

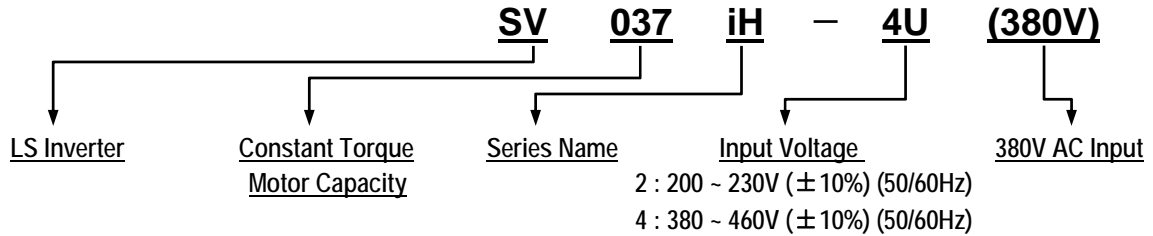

1.2 Environmental Conditions

- ✓ Verify ambient condition for the mounting location.
 - Ambient temperature should not be below 14°F (-10°C) or exceed 104°F (40°C).
 - Relative humidity should be less than 90% (non-condensing).
 - Altitude should be below 3,300ft (1,000m).
- ✓ Do not mount the inverter in direct sunlight and isolate it from excessive vibration.
- ✓ If the inverter is going to be installed in an environment with high probability of penetration of dust, it must be located inside watertight electrical boxes, in order to get the suitable IP degree.

1.3 Mounting

- ✓ The inverter must be mounted vertically with sufficient horizontal and vertical space between adjacent equipment (A= Over 20" (500mm), B= Over 8" (200mm)).

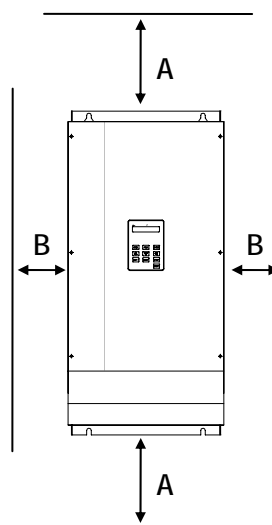

1.4 Other Precautions

- ✓ Do not carry the inverter by the front cover.
- ✓ Do not install the inverter in a location where excessive vibration is present. Be cautious when installing on presses or moving equipment.
- ✓ The life span of the inverter is greatly affected by the ambient temperature. Install in a location where temperature are within permissible limits (- 10 ~ 40 °C).
- ✓ The inverter operates at high-temperatures - install on a non-combustible surface.
- ✓ Do not install the inverter in high-temperature or high-humidity locations.
- ✓ Do not install the inverter in a location where oil mist, combustible gas, or dust is present. Install the inverter in a clean location or in an enclosed panel, free of foreign substance.
- ✓ When installing the inverter inside a panel with multiple inverters or a ventilating fan, use caution. If installed incorrectly, the ambient temperature may exceed specified limits.

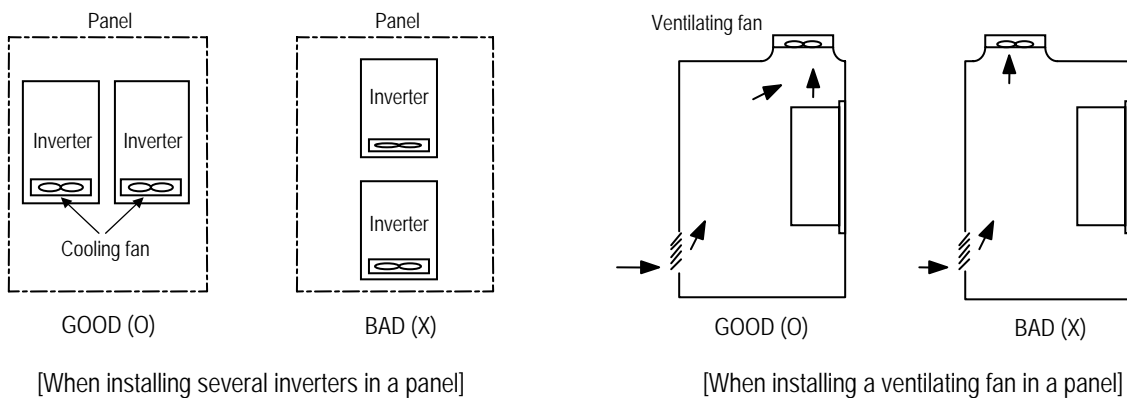

- ✓ Install the inverter using screws or bolts to insure the inverter is firmly fastened.

1.5 Dimensions

Unit: mm (inch)

SV030iH-2U
SV037iH-2U
SV030iH-4U
SV037iH-4U

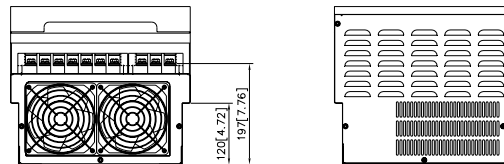
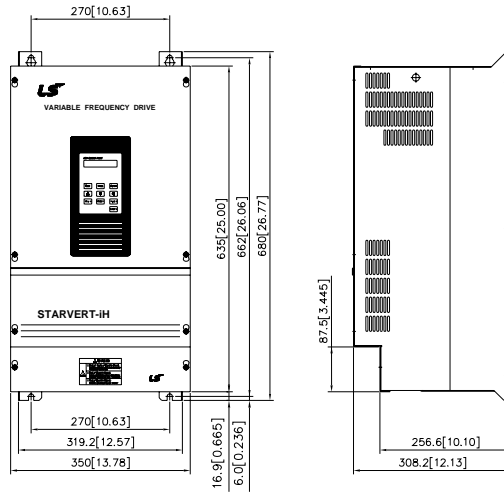

SV045iH-2U
SV055iH-2U

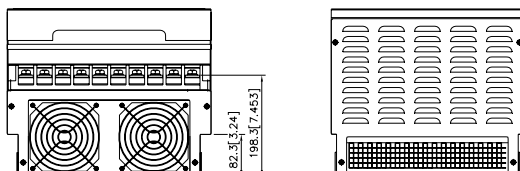
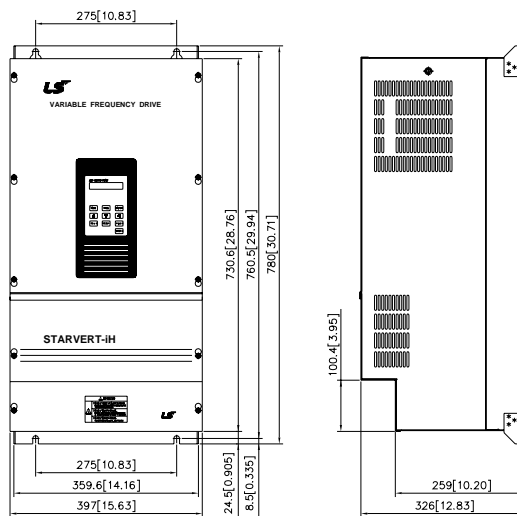

SV045iH-4U
SV055iH-4U
SV075iH-4U

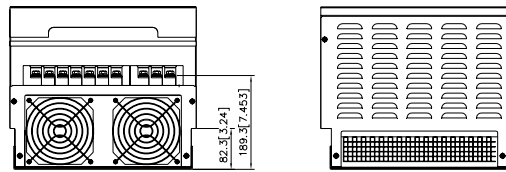
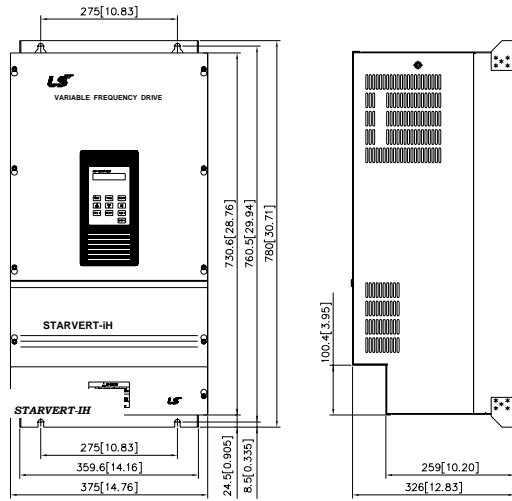

SV090iH-4U
SV110iH-4U

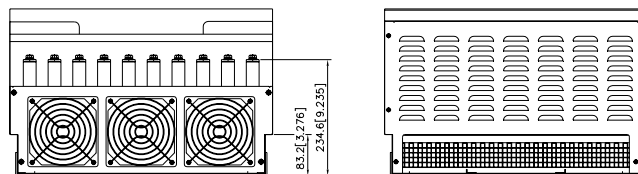
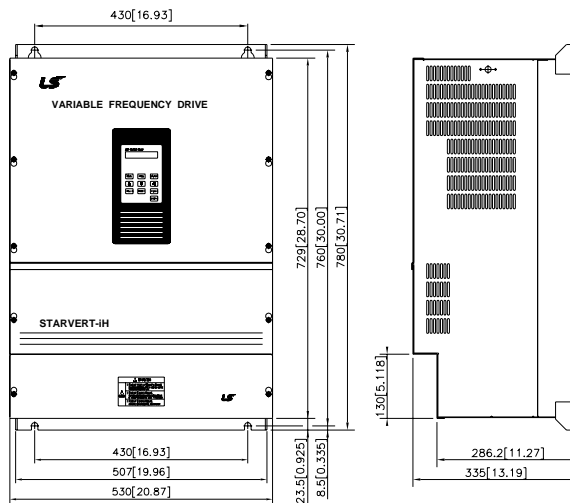

**SV132iH-4U
SV160iH-4U**

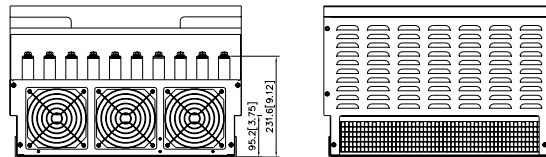
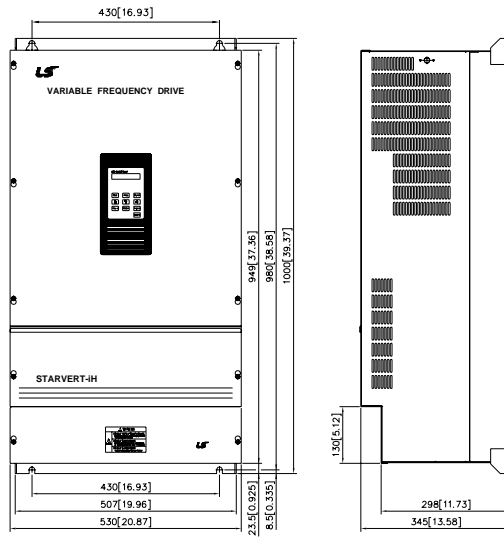

SV220iH-4U

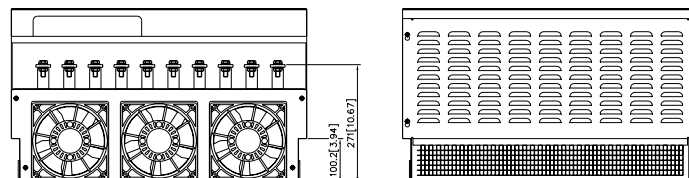
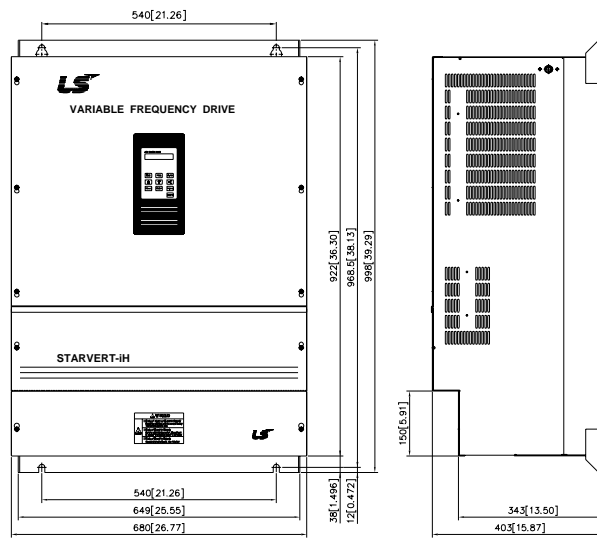

1.6 Basic Wiring

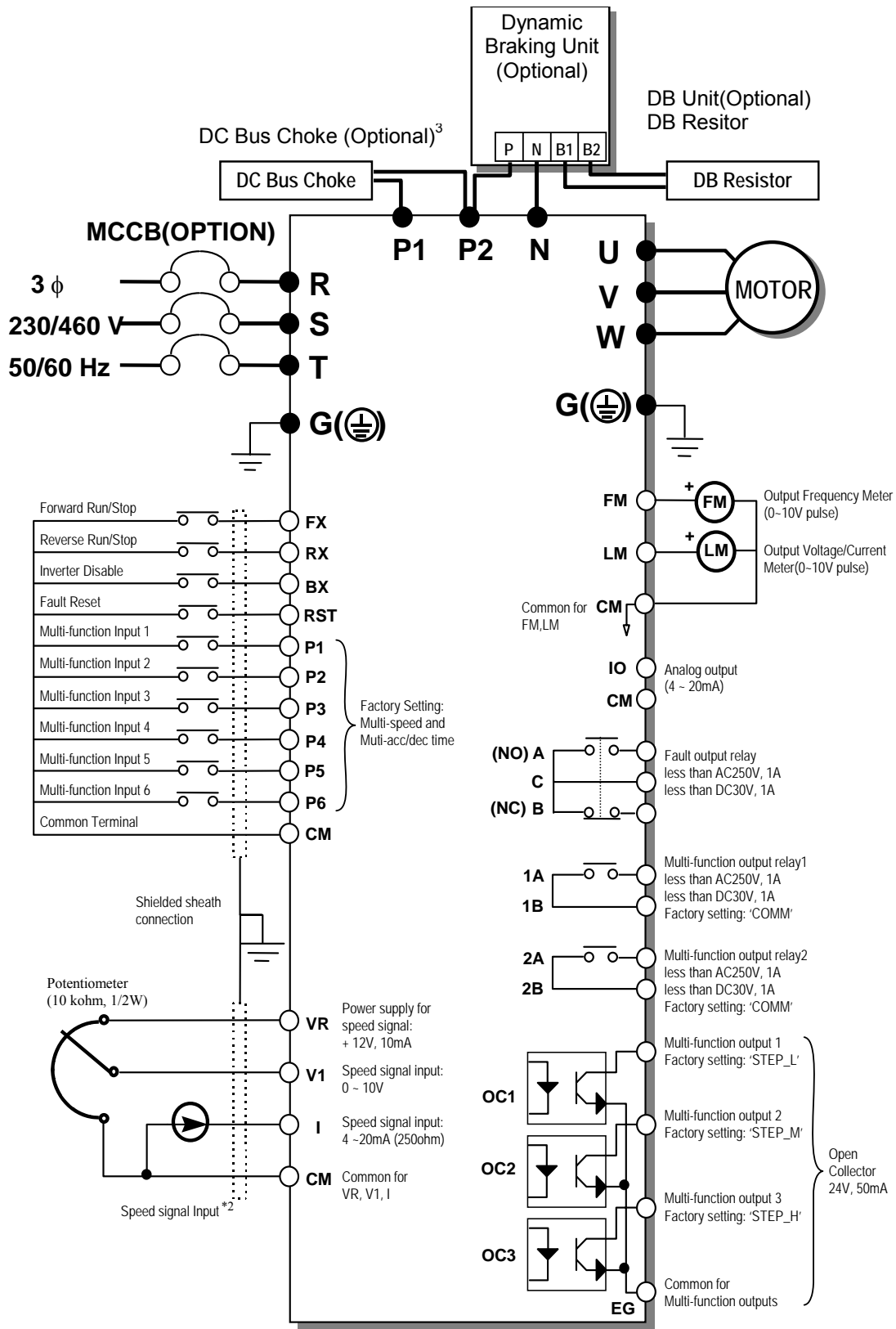

- Note) ● Main Circuit Terminals ○ Control Circuit Terminals.
1. Analog speed command may be set by Voltage, Current or both..
 2. When installing the DC Reactor, the Common Busbar between P1 and P2 must be removed.

1.7 Power Terminals

■ SV045, 055iH-2U

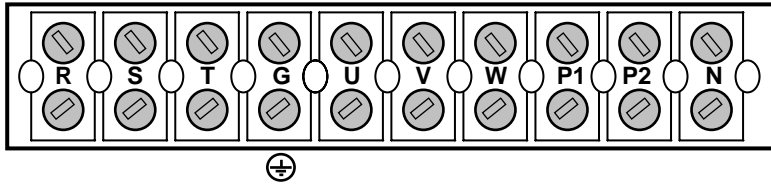

■ SV030, 037iH-2U,
SV030, 037, 045, 055, 075iH-4U

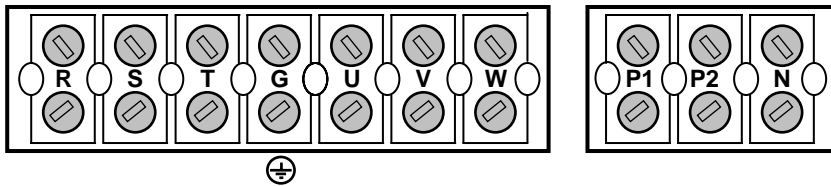

■ SV090, 110, 132, 160, 220iH-4U

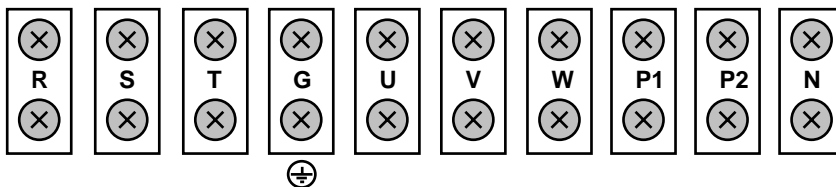

Symbols	Functions
R	AC Line Voltage Input (3 Phase, 200 ~ 230VAC or 380 ~ 460VAC)
S	
T	
G	Earth Ground
P1	<i>Positive DC Bus Terminal</i> External DC Reactor (P1-P2) and DB Unit (P2-P1) Connection Terminals
P2	
N	<i>Negative DC Bus Terminal</i> DB Unit (N-N ¹) Connection Terminal
U	3-Phase Power Output Terminals to Motor (3 Phase, 200 ~ 230VAC or 380 ~ 460VAC)
V	
W	

"Suitable for use on a circuit capable of delivering not more than 10,000 rms symmetrical amperes, 240 volts maximum for 230V class models and 480 volts maximum for 460V class models."

¹ This N terminal is provided on optional Dynamic Braking Unit. (Refer to DB Unit Manual for detail terminal configuration)

1.7.1 Field Wiring Terminals

- 1) Use copper wires only with 600V, 75°C ratings
- 2) Tightening torque of power terminal blocks

Inverter Capacity	Terminal Screw Size	Screw Torque (Kgf·cm)/lb-in	Wire				
			mm ²		AWG		
			R,S,T	U,V,W	R,S,T	U,V,W	
200V Class	30kW	M8	100/70	60	60	1/0	1/0
	37kW	M8	100/70	60	60	1/0	1/0
	45kW	M10	300/210	100	100	4/0	4/0
	55kW	M10	300/210	100	100	4/0	4/0
400V Class	30kW	M8	100/70	22	22	4	4
	37kW	M8	100/70	22	22	4	4
	45kW	M8	100/70	38	38	2	2
	55kW	M8	100/70	38	38	2	2
	75kW	M8	100/70	60	60	1/0	1/0
	90kW	M10	300/210	60	60	1/0	1/0
	110kW	M10	300/210	80	80	3/0	3/0
	132kW	M10	300/210	100	100	4/0	4/0
	160kW	M10	300/210	100	100	4/0	4/0
220kW	M10	300/210	200	200	4/0×2	4/0×2	

* Apply the rated torque to terminal screws. Loose screws can cause of short circuit or malfunction. Tightening the screws too much can damage the terminals and cause a short circuit or malfunction.

* Use copper wires only with 600V, 75°C ratings.

- 3) Input and motor output terminal blocks are intended only for use with ring type connectors.

1.7.2 Terminal Configuration

A Dynamic Braking Unit or a DC Bus Choke or both of them may be added to iH series inverters.

 **Jumper Between P1 and P2 Must Be Removed In Order To Install a DC Bus Choke.**

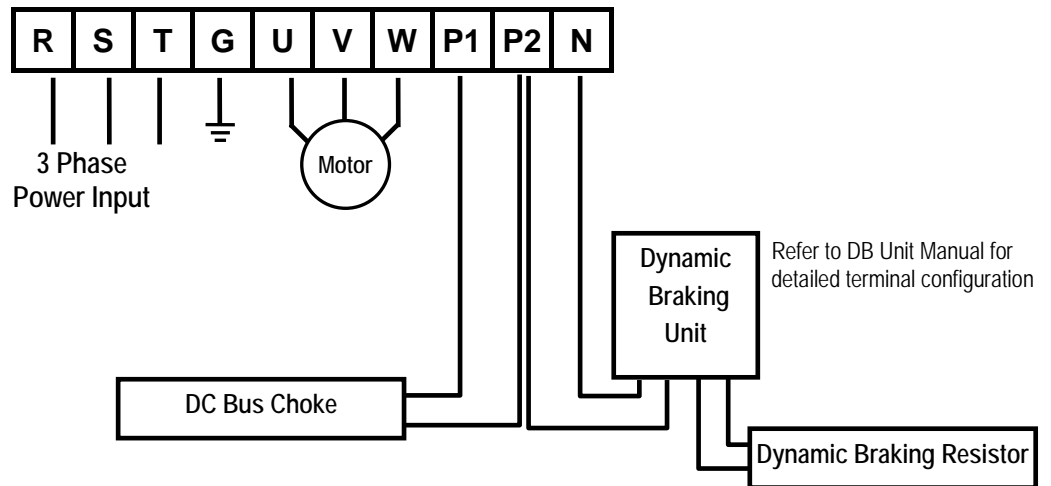



Fig. 1 – Type C Dynamic Braking Unit, DC Bus Choke Installation

 **WARNING**

Normal stray capacitance between the inverter chassis and the power devices inside the inverter and AC line can provide a high impedance shock hazard. Refrain from applying power to the inverter if the inverter frame (Power terminal G) is not grounded.

1.7.3 Wiring Power Terminals

- **Wiring Precautions** 
- ✓ The internal circuits of the inverter will be damaged if the incoming power is connected and applied to output terminals (U, V, W).
- ✓ Use ring terminals with insulated caps when wiring the input power and motor wiring.
- ✓ Do not leave wire fragments inside the inverter. Wire fragments can cause faults, breakdowns, and malfunctions.
- ✓ For input and output, use wires with sufficient size to ensure voltage drop of less than 2%. Motor torque may drop of operating at low frequencies and a long wire run between inverter and motor.
- ✓ Do not use a 3-wire cable for long distances. Due to increased leakage capacitance between wires, over-current protective feature may operate or equipment connected to the output side may malfunction.
- ✓ Never short between B1 and B2 terminals of the inverter.
- ✓ The main circuit of the inverter contains high frequency noise, and can hinder communication equipment near the inverter. To reduce noise, install line noise filters on the input side of the inverter.
- ✓ Do not use power factor capacitor, surge killers, or RFI filters on the output side of the inverter. Doing so may damage these components.
- ✓ Always check whether the LCD and the charge lamp for the power terminal are OFF before wiring terminals. The charge capacitor may hold high-voltage even after the power is disconnected. Use caution to prevent the possibility of personal injury.

- **Grounding** 
- ✓ The inverter is a high switching device, and leakage current may flow. Ground the inverter to avoid electrical shock. Use caution to prevent the possibility of personal injury.
- ✓ Connect only to the dedicated ground terminal of the inverter. Do not use the case or the chassis screw for grounding.
- ✓ The protective earth conductor must be the first one in being connected and the last one in being disconnected.
- ✓ Grounding wire should be at least the size listed in the following table and be as short as possible.

Motor Capacity	Grounding wire dimensions, AWG (mm ²)	
	200V Class	400VClass
30 ~ 37kW	4 (22)	6 (14)
45 ~ 75kW	2 (38)	4 (22)
90 ~ 132kW	-	2 (38)
160 ~ 280kW	-	1/0 (60)

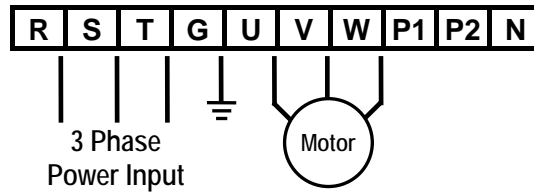
■ Power and Motor Connection

Power supply must be connected to the R, S, and T terminals. Connecting it to the U, V, and W terminals causes internal damages to the inverter. Arranging the phase sequence is not necessary.



Motor should be connected to the U, V, and W terminals. If the forward command (FX) is on, the motor should rotate counter clockwise when viewed from the load side of the motor. If the motor rotates in the reverse, switch the U and V terminals.

1.8 Control Terminals

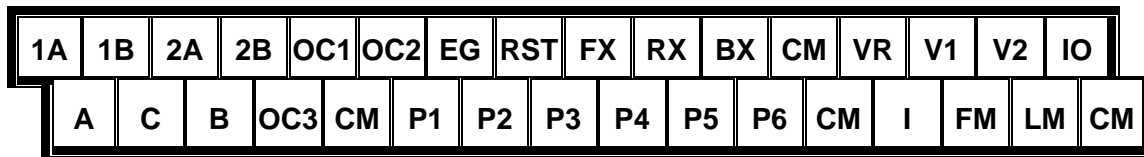

Type	Symbol	Name	Description
Input signal	Starting Contact Function Select	P1 ~ P6	Multi-Function input 1 ~ 6 Used for Multi-Function Input Terminal.
		FX	Forward Run Command Forward Run When Closed and Stopped When Open.
		RX	Reverse Run Command Reverse Run When Closed and Stopped When Open.
		BX	Emergency Stop When the BX Signal is ON the Output of the Inverter is Turned Off. When Motor uses an Electrical Brake to Stop, BX is used to Turn Off the Output Signal. When BX Signal is OFF (Not Turned Off by Latching) and FX Signal (or RX Signal) is ON, Motor continues to Run. ⚠
		RST	Fault Reset Used for Fault Reset.
		CM	Sequence Common Common Terminal for Contact Inputs.
	Analog Frequency Setting	VR	Frequency Setting Power (+10V) Used as Power for Analog Frequency Setting. Maximum Output is +12V, 10mA.
		V1 V2	Frequency Reference (Voltage) Used for 0-10V Input Frequency Reference. Input Resistance is 20 KΩ
		I	Frequency Reference (Current) Used for 4-20mA Input Frequency Reference. Input Resistance is 250 Ω
		CM	Frequency Setting Common Terminal Common Terminal for Analog Frequency Setting
Output signal	Pulse	FM	Frequency Output (For External Monitoring) Outputs PWM signal according to inverter Output Frequency. Maximum Output Voltage and Output Current are 0-12V and 1mA.
		LM	Current/Voltage Output (For External Monitoring) Outputs One of the Following: Output Current, Output Voltage. Default is set to Output Voltage. Maximum Output Voltage and Output Current are 0-12V and 1mA. Output Frequency is Set at 1.8kHz.
	Analog	IO	Frequency Output (4 ~ 2-mA) Outputs Analog Signal according to inverter Output Frequency.
	Contact	A, C, B	Fault Output Relay Activates when Protective Function is Operating. AC250V, 1A or less; DC30V, 1A or less. Fault: 30A-30C Closed (30B-30C Open) Normal: 30B-30C Closed (30A-30C Open)
		1A-1B, 2A-2B	Multi-Function Output Relay 1 and 2 (AUX1, AUX2) Use after Defining Multi-Function Output Terminal. AC250V, 1A or less; DC30V, 1A or less.
		CO1, OC2, OC3	Multi-Function Open Collector Output Use after Defining Multi-Function Output Terminal. DC24V, 50mA
		EG	Multi-Function Open Collector Output Common Terminal Ground Terminal for OC1, OC2, OC3.

1.8.1 Wiring Control Terminals

■ Wiring Precautions

- ✓ CM and EG terminals are insulated to each other. Do not connect these terminals with each other and do not connect these terminals to the power ground.
- ✓ Use shielded wires or twisted wires for control circuit wiring, and separate these wires from the main power circuits and other high voltage circuits.
- ✓ Use 1.25mm² (22AWG) stranded cables for control terminal connection.

■ Control Circuit Terminal

The control input terminal of the control circuit is ON when the current flows out of the terminal, as shown in the following illustration. CM terminal is the common terminal for the contact input signals.

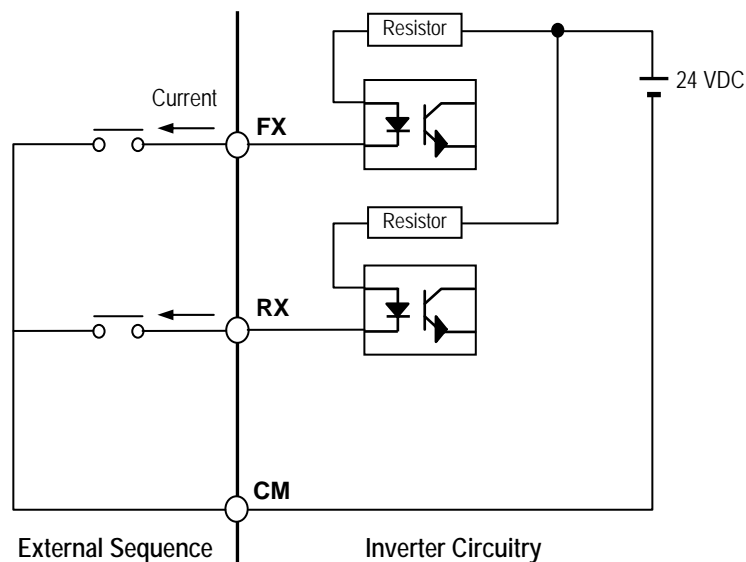

⚠ CAUTION

Do not apply voltage to any control input terminals (FX, RX, P1~P3, BX, RST, FM, LM, IO, CM etc).

CHAPTER 2 - OPERATION

The iH series inverter has three parameter groups separated according to their function, as indicated in the following table.

2.1 Parameter Groups

Group	LCD Keypad (Upper Left Corner)	Description
Drive Group	DRV	Command Frequency, Accel/Decel Time Etc. Basic Parameters
Function Group	FUN	Maximum Frequency, Amount of Torque Boost, Etc. Basic Related Parameters
Input/Output Group	I/O	Multi-Function Terminal Settings. Parameters Needed for Sequence Operation

Refer to the function descriptions in Chapter 5 for detailed description of each group.

2.2 Display

The LCD keypad can display up to 32 alphanumeric characters. Various settings can be checked directly from the display. The keypad is fully upload and download capable. The following is an illustration of the keypad

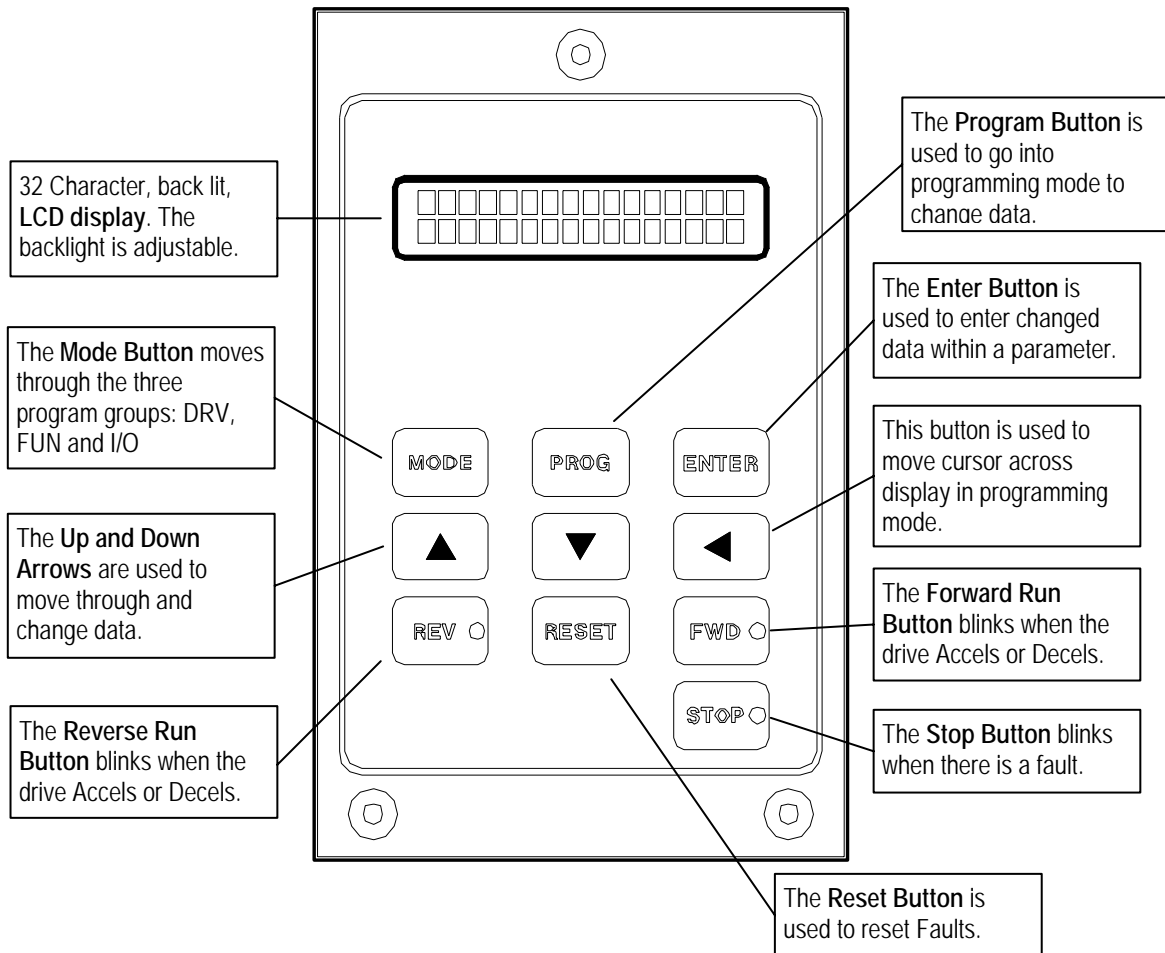



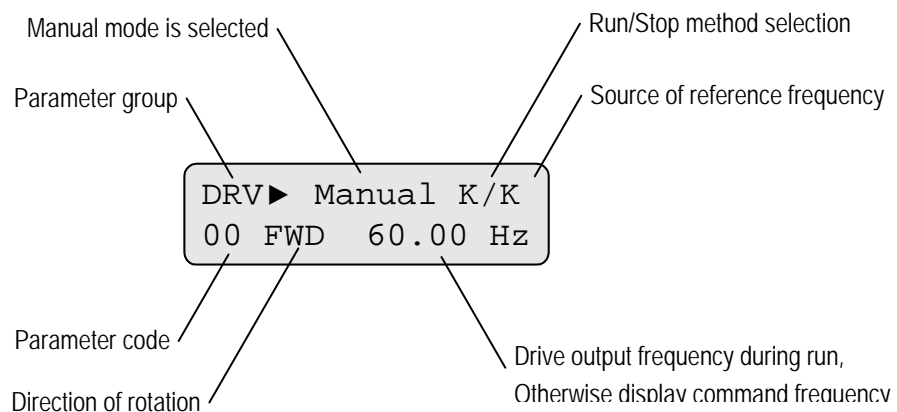





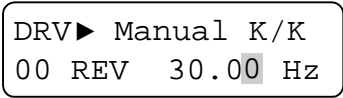
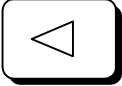
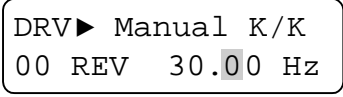

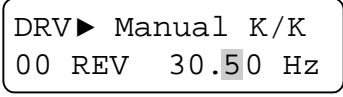

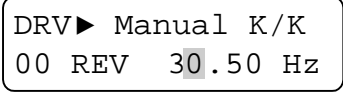
2.3 Alpha-numerical Display

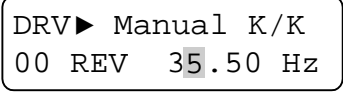

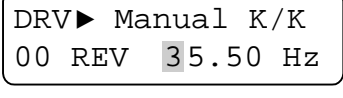
2.4 Procedure of Setting Data

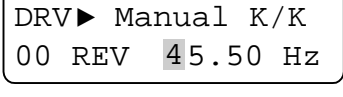
To change command frequency from 30.00Hz to 45.50Hz:

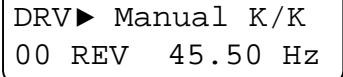
		Press PROG key and the cursor appears on the lowest digit.
		Press LEFT key once to move digit.
		Press UP key 5 times.
		Press SHIFT key once to shift the cursor to next digit.
		Press UP key 5 times.
		Press SHIFT key once to shift the cursor to next digit.
		Press UP key once to make 4.
		Press ENTER key to store new value.

The same procedure is applied to all other parameters. While the drive is running, the output frequency can be changed to a new command frequency.

 **Note:** Some parameters cannot be changed while the inverter is running (refer to the function table in Chapter 4)

2.5 Parameter Navigation

In any of the parameter groups, users may jump to a specific parameter code by following these steps:

- Select a parameter group that requires a change.
- At the beginning of each program group the menu will read [Jump Code]. Press the [PROG] key. Enter the code number of the parameter needing to be changed, then press [ENTER] key. There is no jump code for [Drive Group].

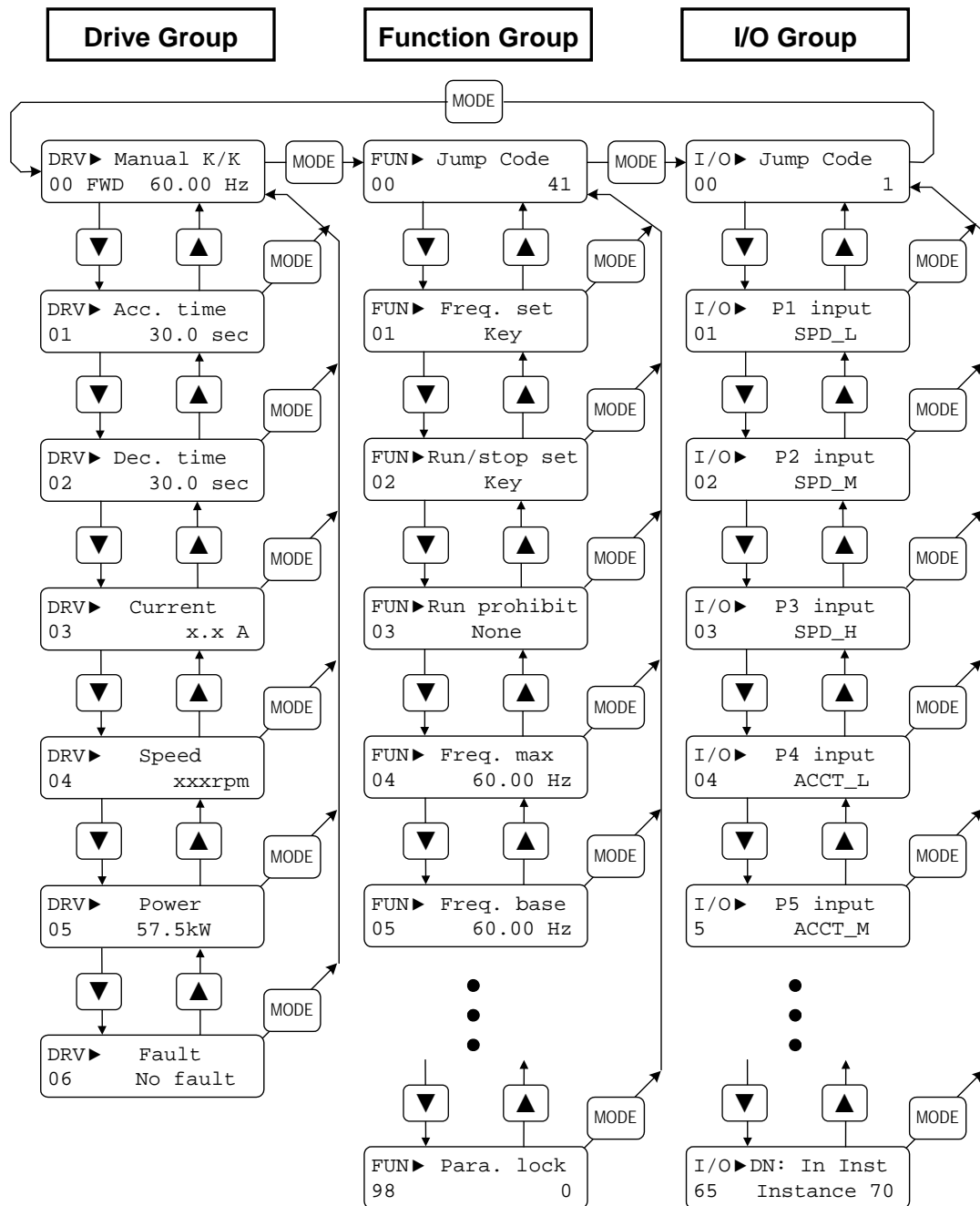

2.6 Operation Method

The iH has several operation methods as shown below.

Operation Method	Function	Function Setting
Operation using keypad	Run/Stop command and frequency are set only through the keypad.	FUN 01: Key FUN 02: Key
Operation using Control Terminals	Closing FX or RX terminal performs Run/Stop. Frequency reference is set through V1 or I terminal.	FUN 01: Terminal FUN 02: Terminal-1 or Terminal-2
Operation using both Keypad and Control Terminals	Run/Stop is performed by the keypad. Frequency reference is set through the V1 or I terminal.	FUN 01: Terminal FUN 02: Key
	Closing FX or RX terminal performs Run/Stop. Frequency reference is set through the keypad.	FUN 01: Key FUN 02: Terminal-1 or Terminal-2
Option	Operation using RS485 communication between inverter and computer.	FUN 01: Remote FUN 02: Remote I/O 48: RS485
	Operation using ModBus RTU communication between inverter and PLC.	FUN 01: Remote FUN 02: Remote I/O 48: ModBus RTU
	Operation using FNet communication between inverter and computer.	FUN 01: Remote FUN 02: Remote I/O 48: Fnet
	Operation using Device Net communication between inverter and computer.	FUN 01: Remote FUN 02: Remote I/O 48: Device Net

CHAPTER 3 - QUICK- START PROCEDURES

These Quick-Start Up instructions are for those applications where:

- The user wants to get the iH inverter started quickly
- The factory-preset values are suitable for the user application

The factory-preset values are shown on the 'Chapter 4 - Parameter List'. The iH inverter is configured to operate a motor at 60Hz (base frequency). If the application requires coordinated control with other controllers, it is recommended the user become familiar with all parameters and features of the inverter before applying AC power.

1. Mounting the inverter (mount the inverter as described in '1.3 Mounting')
 - Install in a clean, dry location
 - Allow a sufficient clearance around top and sides of inverter
 - The ambient temperature should not exceed 40°C (104°F)
 - If two or more inverters are installed in an enclosure, add additional cooling
2. Wiring the inverter (connect wiring as described in '1.7 Power Terminals')
 - AC power should be turned OFF
 - Verify the AC power matches the nameplate voltage

3.1 Operation Using Keypad

1. Apply AC power.

2. If the message of DRV 00 is 'Manual K/K', go to step 11.

```
DRV ▶ Manual K/K
00 FWD  0.00 Hz
```

3. Press the [PROG] key to display function group.

MODE

```
FUN ▶ Jump code
00                               41
```

4. Press the UP-arrow key to display FUN 01.

△

```
FUN ▶ Freq. set
01   Terminal
```

5. Press the [PROG] key to enter into the program mode.

PROG

```
FUN ▶ Freq. set
01   Terminal █
```

6. Using arrow keys, select 'Key', then press the [ENTER] key.

△

```
FUN ▶ Freq. set
01   Key █
```

ENTER

7. Press UP-arrow key to display FUN 02.

△

```
FUN ▶ Run/stop set
02   Terminal-1
```

8. Press [PROG] key to enter into the program mode.

PROG

```
FUN ▶ Run/stop set
02   Terminal-1 █
```

9. Using arrow keys, select 'Key', then press the [ENTER] key.

△

```
FUN ▶ Run/stop set
02   Key █
```

ENTER

10. Press the [MODE] key repeatedly until DRV 00 is displayed.

MODE

```
DRV ▶ Manual K/K
00 FWD  0.00 Hz
```

11. Set the frequency reference by pressing the [PROG] key. Using arrow keys, change the data to 5.00 Hz. Press the [ENTER] key.

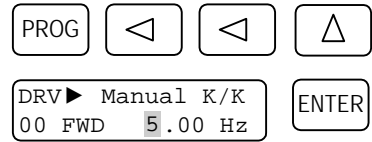

12. Press UP-arrow key to display DRV 01. Change the acceleration time by pressing the [PROG], arrow and [ENTER] keys.

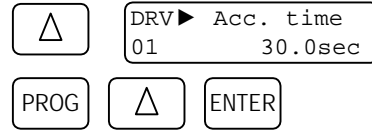

13. Press the UP-arrow key to display DRV 02. Change the Deceleration time by pressing the [PROG], arrow and [ENTER] keys.

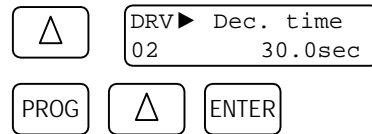

14. Press the [FWD] key to run motor in the forward direction.



15. Press the [REV] key to run motor in the reverse direction.



16. Press the [STOP] key to stop motor.



3.2 Operation Using Control Terminal – External Start, Stop and Speed Reference

1. Confirm ‘Manual T/T’ in DRV 00.

DRV ► Manual T/T
00 FWD 60.00 Hz

2. If different, as in section 3.1 of this chapter, select ‘Terminal’ in FUN 01 and ‘Terminal-1’ or Terminal-2’ in FUN 02.

FUN ► Freq. set
01 Terminal

FUN ► Run/stop set
02 Terminal-1

3. Install a potentiometer on terminals V1, VR and CM as shown right below. Select ‘V1’ in FUN 20 to control the speed by potentiometer alone.

FUN ► V-I mode
20 V

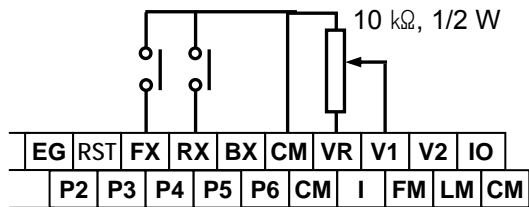

4. Set a frequency reference using the potentiometer. Make sure to observe the set value in DRV 00.

5. When a ‘4 - 20mA’ current source is used as the frequency reference, use terminal I and CM. Select ‘I’ in FUN 20 to control the speed by the current source alone.

FUN ► V-I mode
20 I

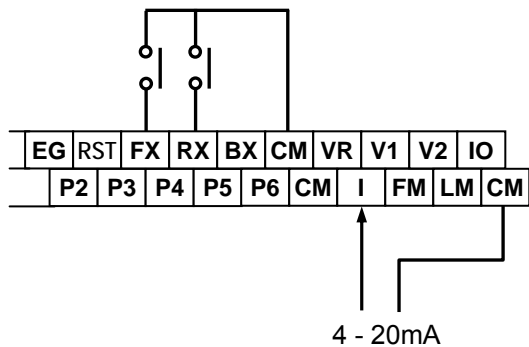

6. To run the motor in the forward direction, close the [FX] terminal to the [CM] terminal.
7. To run the motor in the reverse direction, close the [RX] terminal to the [CM] terminal.

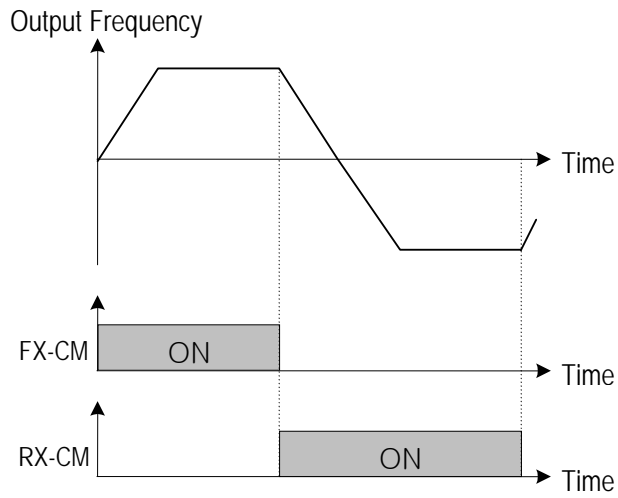

[FUN 02 - 'Terminal-1' Operation]

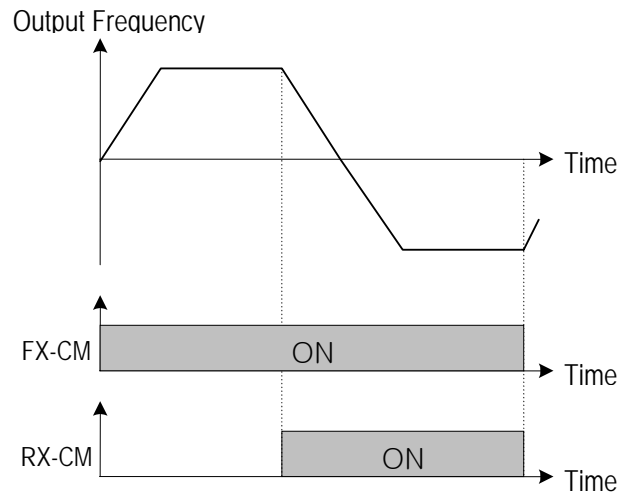

[FUN 02 - 'Terminal-2' Operation]

3.3 Operation Using Both Keypad and Control Terminals

3.3.1 Frequency Set by External Source and Run/Stop Set by Keypad

1. Confirm 'Manual K/T' in DRV 00.

```
DRV ▶ Manual K/T
00 FWD 60.00 Hz
```

2. If different, as in section 3.1 of this chapter, select 'Terminal' in FUN 01 and 'Key' in FUN 02.

```
FUN ▶ Freq. set
01 Terminal
FUN ▶ Run/stop set
02 Key
```

3. Install a potentiometer to terminals V1, VR and CM. Select 'V1' in FUN 20 to control the speed by the potentiometer alone.

```
FUN ▶ V-I mode
20 V1
```

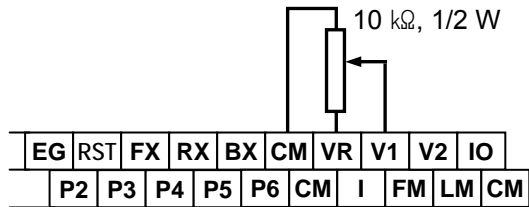

4. Set a frequency reference using the potentiometer. Make sure to observe the set value in DRV 00.

5. When a '4 - 20mA' current source is used as the frequency reference, use terminals I and CM. Select 'I' in FUN 20 to control the speed by the current source alone.

```
FUN ▶ V-I mode
20 I
```

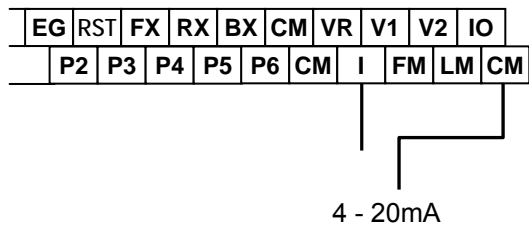

6. To run the motor in the forward direction, press the [FWD] key.

7. To run the motor in the reverse direction, press the [REV] key.

8. To stop the motor, press the [STOP] key.

3.3.2 Frequency Set by Keypad and Run/Stop by External Source

1. Confirm 'Manual T/K' in DRV 00.

```
DRV▶ Manual T/K
00 FWD 60.00 Hz
```

2. If different, as in section 3.1 of this chapter, select 'Key' in FUN 01 and 'Terminal-1' or Terminal-2' in FUN 02.

```
FUN▶ Freq. set
01 Key
```

```
FUN▶ Run/stop set
02 Terminal-1
```

3. Set a frequency reference in DRV 00.

```
DRV▶ Manual T/K
00 FWD 60.00 Hz
```

PROG Δ ENTER

4. To run the motor in the forward direction, close the [FX] terminal to the [CM] terminal.

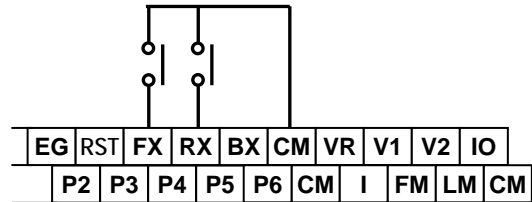

5. To run the motor in the forward direction, close the [RX] terminal to the [CM] terminal.

Blank Page

CHAPTER 4 - PARAMETER LIST

4.1 Drive Group

Code [DRV]	Description Drive Group	Keypad Display	Setting Range	Units	Factory Default	Adj. During Run	Page
00	Output Frequency (During Run) or Reference Frequency (During Stop)	Cmd. Freq	0 to FUN 04	0.01	0.00 [Hz]	Yes	43
01	Acceleration Time	Acc. time	0 to 6000 [sec]	0.1	30 [sec]	Yes	43
02	Deceleration Time	Dec. time	0 to 6000 [sec]	0.1	60 [sec]	Yes	43
03	Output Current	Current	The Load Current in RMS	-	- [A]	-	43
04	Output Speed	Speed	The Motor Speed in RPM	-	- [rpm]	-	43
05	Output Power Display	Power	Inverter Output Power	-	- [kW]	-	43
06	Fault Display	Fault	-	-	-	-	43

4.2 Function Group

Code [FUN]	Description Function Group	Keypad Display	Setting Range	Units	Factory Default	Adj. During Run	Page
00	Jump to Desired Code #	Jump Code	1 to 98	1	41	Yes	45
01	Frequency Setting Mode	Freq. set	Key, Terminal, Remote	-	Key	No	45
02	Run / Stop Mode Selection	Run/stop set	Key, Terminal-1, Terminal-2, Remote	-	Key	No	45
03	Run Prevention	Run prohibit	None, FWD disable, REV disable	-	None	No	46
04	Maximum Frequency Output Set Point	Freq. max	40 to 400 [Hz]	0.01	60 [Hz]	No	46
05	Base Frequency	Freq. base	40 to FUN 04	0.01	60 [Hz]	No	46
06	Starting Frequency	Freq. start	0.5 to 5[Hz]	0.01	0.5 [Hz]	No	46
07	Starting Frequency Hold Time	Hold time	0 to 10 [sec]	0.1	0.0 [sec]	Yes	47
08	Volts / Hz Pattern	V/F pattern	Linear, 2.0 (Squared), User, Auto	-	Linear	No	47
09	Torque Boost in Forward Direction	Fwd boost	0 to 20 [%]	1	2 [%]	No	48
10	Torque Boost in Reverse Direction	Rev boost	0 to 20 [%]	1	2 [%]	No	48
11	Acceleration Pattern	Acc. pattern	Linear, S-Curve, U-curve	-	Linear	No	49
12	Deceleration Pattern	Dec. pattern	Linear, S-Curve, U-Curve	-	Linear	No	49
13	Output Voltage Adjustment	Volt control	40 to 110 [%]	1	100 [%]	No	49

Chapter 4 - Parameter List

Code [FUN]	Description Function Group	Keypad Display	Setting Range	Units	Factory Default	Adj. During Run	Page
14	Energy Savings Level	Energy save	70 to 100 [%]	1	100 [%]	Yes	50
15	Stop Mode Selection	Stop mode	Decel, DCBR, Free Run	-	Decel	No	50
16	User V/F - Frequency 1	User-1f	0 to 30 [Hz]	0.01	10.00 [Hz]	No	51
17	User V/F - Voltage 1	User-1v	0 to 50 [%]	1	15 [%]	No	51
18	User V/F - Frequency 2	User-2f	FUN 16 to FUN 04	1	30.00 [Hz]	No	51
19	User V/F - Voltage 2	User-2v	FUN 17 to 100 [%]	1	50 [%]	No	51
20	Analog Speed Input Selection	V-I mode	V1, I, V1 + I, V2	-	V1	No	51
21	Analog Speed Input Filter Gain	Filter gain	1 to 100 [%]	1	25 [%]	Yes	52
22	Analog Speed Input Gain	Analog gain	50 to 250 [%]	0.1	100.0 [%]	Yes	52
23	Analog Speed Input Bias	Analog bias	0 to 200 [%]	0.1	100.0 [%]	Yes	52
24	Analog Speed Input Direction	Analog dir	Direct, Invert	-	Direct	Yes	52
25	Frequency Limit Selection	Freq. limit	No, Yes	-	No	No	54
26	Frequency High Limit Selection	F-limit high	0 to FUN 04	0.01	60.00 [Hz]	No	54
27	Frequency Low Limit Selection	F-limit low	0 to FUN 26	0.01	0.00 [Hz]	No	54
28	Jump Frequency Selection	Freq. jump	No, Yes	-	No	No	54
29	Jump Frequency 1	Freq-jump 1f	0 to FUN 04	0.01	10.00 [Hz]	No	54
30	Jump Frequency 2	Freq-jump 2f	0 to FUN 04	0.01	20.00 [Hz]	No	54
31	Jump Frequency 3	Freq-jump 3f	0 to FUN 04	0.01	30.00 [Hz]	No	54
32	Jump Frequency Bandwidth	Freq. band	0 to 30 [Hz]	0.01	5.00 [Hz]	No	54
33	DC Injection Braking Frequency	DC-br freq	0 to 60 [Hz]	0.01	0.50 [Hz]	No	55
34	DC Injection Braking On-Delay Time	DC-br block	0.5 to 5 [sec]	0.1	2 [sec]	No	55
35	DC Injection Braking Time	DC-br time	0.1 to 25 [sec]	0.1	0.5 [sec]	No	55
36	DC Injection Braking Voltage	DC-br value	1 to 20 [%]	1	1 [%]	No	55
37	Slip Compensation	Slip compen.	No, Yes	-	No	No	56
38	Rated Motor Slip	Rated slip	0 to 5 [Hz]	0.01	0.00 [Hz]	No	56
39	Rated Motor Current (RMS)	M-rated cur.	0.1 to 999 [A]	0.1	103.0 [A] ¹	No	56
40	No Load Motor Current in RMS	No-load cur.	0.1 to 300 [A]	0.1	0.1 [A]	No	56
41	Inverter Capacity	Inv Capacity	SV030iH-2U SV037iH-2U · · · · · · SV315iH-4U	-	SV030iH-2 ²	No	56

¹ Default value will depend on the inverter capacity.

² FUN 41 is set at its inverter capacity before shipping outside. However, inverter loses its capacity after parameter initialization in FUN 97. If the parameters are initialized, be sure to re-set the inverter capacity to the right capacity.

Code [FUN]	Description Function Group	Keypad Display	Setting Range	Units	Factory Default	Adj. During Run	Page
			SV375iH-4U				
42	Number of Auto Restart attempt	Retry number	0 to 10	1	0	Yes	56
43	Delay Time Before Auto Restart	Retry time	0 to 10 [sec]	1	1 [sec]	Yes	56
44	Fault Output Relay (A, C, B)	Relay mode	Retry 0, All Trips, LV + Retry 0, LV + All Trips	-	Retry 0	Yes	57
45	Stall Prevention Mode	Stall mode	None, Acc, Steady, Acc + Steady, Dec, Acc + Dec, Dec + Steady, Acc + Dec+ Steady	-	None	Yes	57
46	Stall Prevention Level	Stall level	CT: 30 to 150 [%] VT: 30 to 110 [%]	1 1	150 [%] 110 [%]	Yes Yes	57
47	Overload Warning Level	OL level	CT: 30 to 150 [%] VT: 30 to 110 [%]	1 1	150 [%] 110 [%]	Yes Yes	58
48	Overload Warning Hold Time	OL time	1 to 30 [sec]	1	10 [sec]	Yes	58
49	Over Current Trip Limit Level	OC lim level	CT: 30 to 200 [sec] VT: 30 to 150 [sec]	1 1	160 [%] 110 [%]	Yes Yes	59
50	Over Current Limit Time	OC lim. Time	0 to 60 [sec]	0.1	60 [sec]	Yes	59
51	Electronic Thermal Selection	ETH select	No, Yes	-	No	Yes	59
52	Electronic Thermal Level	ETH level	110 to 150 [%]	1	150 [%]	Yes	59
53	Electronic Thermal Characteristic (Motor Type) Selection	Motor type	General, Special	-	General	Yes	59
54	Number of Motor Poles	Pole number	2 to 12	1	4	Yes	60
55	IPF (Instant Power Failure) Restart Selection	IPF select	No, Yes	-	No	Yes	61
56	Speed Search Acceleration Time	SS acc. time	0.1 to 600 [sec]	0.1	5 [sec]	Yes	61
57	Speed Search Deceleration Time	SS dec. Time	0.1 to 600 [sec]	0.1	10 [sec]	Yes	61
58	Speed Search Gain	SS gain	0 to 200 [%]	1	100 [%]	Yes	61
59	Restart after Fault Reset Selection	RST-restart	No, Yes	-	No	Yes	61
60	Restart after Power-On Selection	Power on st	No, Yes	-	No	Yes	62
61	Carrier Frequency	Carrier Freq	2 to 10 [kHz]	1	6 [kHz] ³	No	62

³ Carrier Frequency according to the Inverter Capacity (The Carrier Frequency is set to 3kHz for VT Rating)

Inverter	Setting Range	Factory Default	Inverter	Setting Range	Factory Default
SV030iH-2U	2 to 10	6kHz	SV075iH-4U	2 to 7	6kHz
SV037iH-2U	2 to 10	6kHz	SV090iH-4U	2 to 6	6kHz
SV045iH-2U	2 to 8	6kHz	SV110iH-4U	2 to 6	6kHz

Chapter 4 - Parameter List

Code [FUN]	Description Function Group	Keypad Display	Setting Range	Units	Factory Default	Adj. During Run	Page
62	PI Control Selection	PI-control	No, Yes	-	No	No	63
63	PI Proportional Gain	P-gain	1 to 30000	1	10	Yes	63
64	PI Integral Gain	I-gain	1 to 30000	1	50	Yes	63
65	PI Feedback Selection	PI-fb select	I, V1, V2	-	I	No	63
66	PI Feedback Filter Gain	PI-fb filt. G	1 to 100 [%]	1	25 [%]	Yes	63
67	PI Feedback Gain	PI-fb gain	50 to 250 [%]	0.1	100.0 [%]	Yes	63
68	PI Feedback Bias	PI-fb bias	0 to 200 [%]	0.1	100.0 [%]	Yes	63
69	PI Feedback Direction	PI-fb dir	Direct, Invert	-	Direct	No	63
70	PI I Gain Scale	I_term scale	1 to 100 [%]	1	100 [%]	Yes	63
71	PI Controller Error Direction	PI error dir	Direct, Invert	-	Direct	No	63
72	PI Control Bypass	Regul bypass	No, Yes	-	No	No	63
94 ⁴	CT/VT Selection	CT/VT	Constant Trq, Variable Trq	-	Constant Trq	No	64
95	Read Parameters into Keypad from Drive	Para. Read	No, Yes	-	No	No	64
96	Write Parameters to Drive from Keypad	Para. Write	No, Yes	-	No	No	64
97	Initialize Parameters to Factory Default Settings	Para. Init	No, Yes	-	No	No	64
98	Parameter Write Protection	Para. Lock	0 to 255	1	0	Yes	64

SV055iH-2U	2 to 8	6kHz	SV132iH-4U	2 to 5	5kHz
SV030iH-4U	2 to 10	6kHz	SV160iH-4U	2 to 4	4kHz
SV037iH-4U	2 to 10	6kHz	SV220iH-4U	2 to 4	4kHz
SV045iH-4U	2 to 8	6kHz	SV315iH-4U	2 to 4	4kHz
SV055iH-4U	2 to 8	6kHz	SV375iH-4U	2 to 4	4kHz

⁴ VT is available only for 400V class inverter.

4.3 I/O Group

Code [I/O]	Description Function Group	Keypad Display	Setting Range	Units	Factory Default	Adj. During Run	Page
00	Jump to Desired Code #	Jump Code	1 to 65	1	1	Yes	65
01	Multi-function Input 1 (P1 terminal)	P1 Input	SPD_L, SPD_M, SPD_H, JOG, ACCT_L, ACCT_M, ACCT_H, UP, DOWN, HOLD, DIS_OPT, COMM_CONN, EXT_DCBR, EXT_TRIP	-	SPD_L	No	65
02	Multi-function Input 2 (P2 terminal)	P2 Input		-	SPD_M	No	65
03	Multi-function Input 3 (P3 terminal)	P3 Input		-	SPD_H	No	65
04	Multi-function Input 4 (P4 terminal)	P4 Input		-	ACCT_L	No	65
05	Multi-function Input 5 (P5 terminal)	P5 Input		-	ACCT_M	No	65
06	Multi-function Input 6 (P6 terminal)	P6 Input		-	ACCT_H	No	65
07	Multi-function Output 1 (OC1 terminal)	OC1 Output	FST_LO, FST_HI, FDT_HI, FDT_PULSE, FDT_BAND, OL, STALL, LV, RUN, COMM, STEP_L, STEP_M, STEP_H	-	STEP_L	No	68
08	Multi-function Output 2 (OC2 terminal)	OC2 Output		-	STEP_M	No	68
09	Multi-function Output 3 (OC3 terminal)	OC3 Output		-	STEP_H	No	68
10	Multi-function Output 4 (Aux.1 Relay term.)	AUX1 output		-	COMM	No	68
11	Multi-function Output 5 (Aux. 2 Relay term.)	AUX2 output		-	COMM	No	68
12	Jog Frequency	Jog freq.	0 to FUN 04	0.01	30.00 [Hz]	Yes	72
13	Step Speed 1	Step freq-1	0 to FUN 04	0.01	10.00 [Hz]	Yes	72
14	Step Speed 2	Step freq-2	0 to FUN 04	0.01	20.00 [Hz]	Yes	72
15	Step Speed 3	Step freq-3	0 to FUN 04	0.01	30.00 [Hz]	Yes	72
16	Step Speed 4	Step freq-4	0 to FUN 04	0.01	40.00 [Hz]	Yes	72
17	Step Speed 5	Step freq-5	0 to FUN 04	0.01	50.00 [Hz]	Yes	72
18	Step Speed 6	Step freq-6	0 to FUN 04	0.01	46.00 [Hz]	Yes	72
19	Step Speed 7	Step freq-7	0 to FUN 04	0.01	37.00 [Hz]	Yes	72
20	Acceleration Time 1	Acc time-1	0 to 6000 [sec]	0.1	1.0 [sec]	Yes	72
21	Deceleration Time 1	Dec time-1	0 to 6000 [sec]	0.1	1.0 [sec]	Yes	72
22	Acceleration Time 2	Acc time-2	0 to 6000 [sec]	0.1	2.0 [sec]	Yes	72
23	Deceleration Time 2	Dec time-2	0 to 6000 [sec]	0.1	2.0 [sec]	Yes	72
24	Acceleration Time 3	Acc time-3	0 to 6000 [sec]	0.1	3.0 [sec]	Yes	72
25	Deceleration Time 3	Dec time-3	0 to 6000 [sec]	0.1	3.0 [sec]	Yes	72
26	Acceleration Time 4	Acc time-4	0 to 6000 [sec]	0.1	4.0 [sec]	Yes	72
27	Deceleration Time 4	Dec time-4	0 to 6000 [sec]	0.1	4.0 [sec]	Yes	72

Chapter 4 - Parameter List

Code [I/O]	Description Function Group	Keypad Display	Setting Range	Units	Factory Default	Adj. During Run	Page
28	Acceleration Time 5	Acc time-5	0 to 6000 [sec]	0.1	5.0 [sec]	Yes	72
29	Deceleration Time 5	Dec time-5	0 to 6000 [sec]	0.1	5.0 [sec]	Yes	72
30	Acceleration Time 6	Acc time-6	0 to 6000 [sec]	0.1	6.0 [sec]	Yes	72
31	Deceleration Time 6	Dec time-6	0 to 6000 [sec]	0.1	6.0 [sec]	Yes	72
32	Acceleration Time 7	Acc time-7	0 to 6000 [sec]	0.1	7.0 [sec]	Yes	72
33	Deceleration Time 7	Dec time-7	0 to 6000 [sec]	0.1	7.0 [sec]	Yes	72
34	Output Voltage / Current Meter (LM Meter) Selection	LM meter	Voltage, Current	-	Voltage	Yes	72
35	Output Voltage / Current Meter (LM Meter) Adjustment (15V Pulse)	LM adj.	0 to 120 [%]	1	100 [%]	Yes	72
36	FM Meter Output Adjustment (15V Pulse)	FM adj.	0 to 120 [%]	1	100 [%]	Yes	73
37	IO Meter Output Adjustment (4 to 20mA)	IO adj.	0 to 120 [%]	1	100 [%]	Yes	73
38	Frequency Steady Level	FST-freq.	0 to FUN 04	0.01	0.50 [Hz]	No	73
39	Frequency Detection Level	FDT-freq.	0 to FUN 04	0.01	60.00 [Hz]	No	73
40	Frequency Detection Bandwidth	FDT-band	0 to 30 [Hz]	0.01	1.00 [Hz]	No	73
41	Multiplier Constant for Speed Display in 'DRV 04'	Mul. Factor	0 to 999	1	100	Yes	74
42	Divider Constant for Speed Display in 'DRV 04'	Div. factor	1 to 999	1	100	Yes	74
43	Status of Input Terminals	Ter. Input	-	-	-	-	74
44	Status of Output Terminals	Ter. Output	-	-	-	-	74
45	Software Version	S/W version	-	-	2.xx	-	74
46	Fault History 1	Last fault 1	Fault Status, Freq. at Fault Current at Fault	-	-	Yes	74
47	Fault History 2	Last fault 2		-	-	Yes	74
48	Option 1 Selection	Option 1	None, RS485, ModBus RTU, Fnet, Device Net	-	None	No	75
49	Option 2 Selection	Option 2	None, MMC	-	None	No	75
50 ⁵	Inverter number for Option	Inv. Number	1 to 31	1	1	Yes	75
51	Baud rate for Option	Baud-rate	1200, 2400, 4800, 9600, 19200	-	9600 BPS	Yes	75
52	Communication Timeout	Comm. Timeout	0 to 60 [sec]	0.1	10.0 [sec]	Yes	75
53	PG Slip Frequency for PG Option	PG Slip Freq	0 to 10 [Hz]	0.01	5.00 [Hz]	No	76
54	PG-P Gain for PG Option	PG. P-Gain	0 to 225	1	1	Yes	76
55	PG-I Gain for PG Option	PG. I-Gain	0 to 225	1	1	Yes	76
56	PG-Filter Gain for PG Option	PG. F-Gain	0 to 225	1	100	Yes	76
57	Encoder Selection for PG Option	Enc pulse	100,	-	512 Pulse	Yes	76

⁵ Option related parameters (FUN 50 ~ FUN 61) - Please refer to specific option manual.

Code [I/O]	Description Function Group	Keypad Display	Setting Range	Units	Factory Default	Adj. During Run	Page
			500, 512, 1000, 1024, 2000, 2048, 4000				
58	Digital Input for DI/DA Option	DI Mode	None, Freq. 1, Freq. 2	-	Freq.1	Yes	76
59	Analog Output for DI/DA Option	DA Mode	Freq., Voltage, Current	-	Freq.	Yes	76
60	Analog Output Adjustment	DA adj.	80 to 120 [%]	1	100 [%]	Yes	76
61	Inverter Number for FNet	FN: St.ID	1 to 63	1	1	No	77
62	Device Net ID	DN: MAC ID	0 to 63	1	0	Yes	77
63	Device Net Communication Speed	DN: Baud Rate	125 kBPS 250 kBPS 500 kBPS	-	125 kBPS	Yes	77
64	Device Net Output Instance	DN: Out Inst	20 21 100 101	-	20	No	77
65	Device Net Input Instance	DN: In Inst	70 71 110 111	-	70	No	77

Blank Page

CHAPTER 5 - PARAMETER DESCRIPTION

5.1 Drive Group [DRV]

DRV 00: Output Frequency / Reference Frequency

DRV ▶ Manual K/K
00 FWD 60.00 Hz

Setting Range: 0 to FUN 04 [Freq. max]
Factory Default: 0.00 Hz

When the inverter is stopped, the LCD display will read “Reference Frequency”. This is the Target Set Frequency. While the inverter is running, the LCD display will read “Output Frequency”.

The Output Frequency may be controlled by the digital **Keypad** or analog input (**Speed pot**) or (**4 ~ 20mA**). The factory default is [Keypad] mode. To change the output frequency from Keypad to Terminal, go to [FUN 01].

DRV 01: Acceleration Time DRV 02: Deceleration Time

DRV ▶ Acc. Time
01 30.0 sec

DRV ▶ Dec. Time
02 60.0 sec

Setting Range: 0 to 6000 sec
Factory Default: 5.0 sec

The inverter targets [FUN 04] when accelerating or decelerating. When [FUN 04] is set to ‘Maximum Frequency’, the acceleration time is the time taken by the motor to reach [FUN 04] from 0 Hz. The deceleration time is the time taken by the motor to reach 0 Hz from [FUN 04] (Maximum Frequency).

The acceleration and deceleration time can be changed to a preset transient time via multi-function inputs. By setting the multi-function

inputs (P1~P6) to ‘ACCT_L’, ACCT_M’, ‘ACCT_H’ respectively, the Accel and Decel time set in [I/O 01] to [I/O 06] are supplied according to preset speeds assigned in [I/O 20] to [I/O 33].

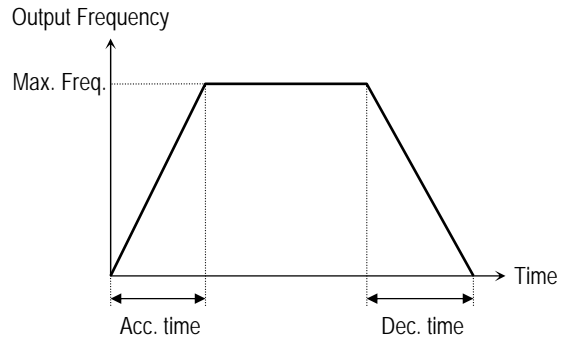

[Accel/Decel Operation]

DRV 03: Output Current

DRV ▶ Current
03 10.0 A

Displays RMS value of the output current when the drive is running.

DRV 04: Output Speed

DRV ▶ Speed
04 1800 rpm

Displays the speed of the motor in RPM. Line speed of the motor (m/min.) can be calculated by the number of motor poles [FUN 54] and the “Multiplier and Divider Factor” [I/O 41], [I/O 42].

DRV 05: Output Power Display

```
DRV▶   Power
05     47.8kW
```

Displays inverter output power (kW) when the drive is running.

DRV 06: Fault Display

```
DRV▶   Fault
05     No Fault
```

Displays the status of a fault. The output of the inverter is turned off when a fault condition occurs. The condition at the time of the fault can be examined (Motor Current and Output Frequency). The Stop LED blinks when a fault has occurred. The following table shows the fault item.

Display	Fault	Remark
OC Trip	Over Current	Latch
OV Trip	Over Voltage	Latch
EXT Trip	External Trip	Latch
BX	Inverter Disable	Unlatch
LV Trip	Low Voltage	Unlatch
Fuse Open	Fuse Blown	Latch
GF Trip	Ground Fault	Latch
Over Heat	Cooling Problem	Latch
ETH	Electronic Thermal Protected	Latch
OC Limit	Over Current	Latch
M/C Fail	Magnetic Contactor Problem	Unlatch
Inv OLT	Inverter Overload	Latch
SC Trip ¹	Short Through Trip	Latch

- **Note:** A latched fault must be released by the [RESET] key or reset (RST) terminal. Unlatched faults are released upon condition or command.

¹ Available for models over 220kW. To reset this fault, the main input power should be disconnected.

5.2 Function Group

FUN 00: Jump to Desired Code

FUN ▶ Jump Code
00 41

Setting Range: 0 to 98
Factory Default: 41

Any program code may be jumped to directly by entering the desired program code number.

Press the [PROG] key, scroll with the [▲ ▼] keys to the desired program code, then press the [ENTER] key to move to a desired program code.

FUN 01: Frequency Setting Mode

FUN ▶ Freq. set
01 Key

Setting Range: Key, Terminal, Remote
Factory Default: Key

Key: The target frequency is controlled and established using the Keypad in [DRV 00].

Terminal: The target frequency is controlled and established using the Terminal with an analog speed pot (10V DC) or a (4 ~ 20mA) current signal.

Remote: The target frequency is controlled and established using Option Board.

- **Note:** Analog input may be fine tuned when controlling the target frequency through the Terminal. (See FUN 20~22)

FUN 02: Run/Stop Mode Selection

FUN ▶ Run/stop set
02 Key

Setting Range: Key, Terminal-1, Terminal-2, Remote
Factory Default: Key

This function selects Keypad, Terminal-1, Terminal-2 or Remote (Option Board) as the source for the Run/Stop command.

Key: Run/Stop is controlled by Keypad.

Terminal-1: Control terminals FX, RX and CM control Run/Stop.

FX-CM: Forward Run and Stop Control

RX-CM: Reverse Run and Stop Control

Terminal-2: Control terminals FX, RX and CM control Run/Stop.

FX-CM: Run/Stop control.

RX-CM: Forward and Reverse Control (Toggle)

Remote: Communication Option controls Run/stop.

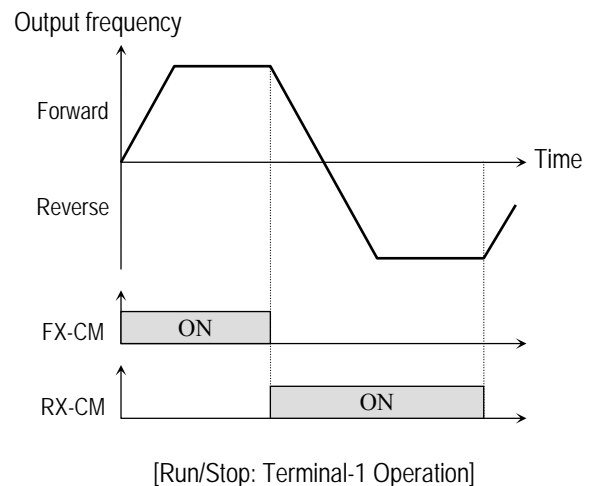

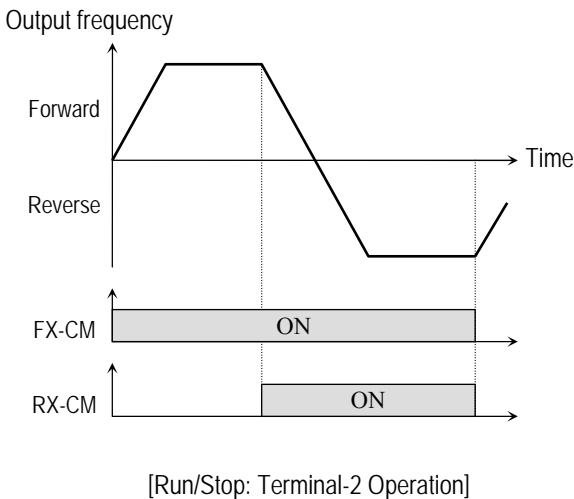

FUN 03: Run Prevention

FUN ▶ Run prohibit
03 None

Setting Range: None, FWD disable, REV disable
Factory Default: None

This function prevents reverse operation of the motor. This function may be used for loads that rotate only in one direction such as fans and pumps.

Setting Range	Description
None	Forward and Reverse run is available.
FWD disable	Forward run is prevented.
REV disable	Reverse run is prevented.

FUN 04: Maximum Frequency Set Point

FUN ▶ Freq. max
04 60.00 Hz

Setting Range: 40 ~ 400 Hz
Factory Default: 60.00 Hz

This function selects the maximum frequency output of the inverter. Caution should be exercised when increasing the motor's command speed beyond its nameplate RPM. Please check with the motor manufacturer before exceeding the base speed of the motor.

FUN 05: Base Frequency Set Point

FUN ▶ Freq. base
05 60.00 Hz

Setting Range: 40 to FUN 04 [Freq. max]
Factory Default: 60.00 Hz

This function selects the output frequency of the inverter when operating at rated output voltage. Base frequency cannot be set above the maximum frequency. [FUN 04] establishes the frequency for maximum output voltage. This parameter is normally set to 60Hz. This allows constant torque operation of the motor up to its base speed. If base frequency is set to 60Hz and maximum frequency is set to 120Hz, the motor will run in the constant torque range up to the motor's base frequency, and in the constant horse power range from the motor's base frequency to twice the motor's base frequency.

FUN 06: Start Frequency Set Point

FUN ▶ Freq. start
06 0.50 Hz

Setting Range: 0.5 to 5Hz
Factory Default: 0.50 Hz

This function selects the start frequency when the inverter starts to output voltage.

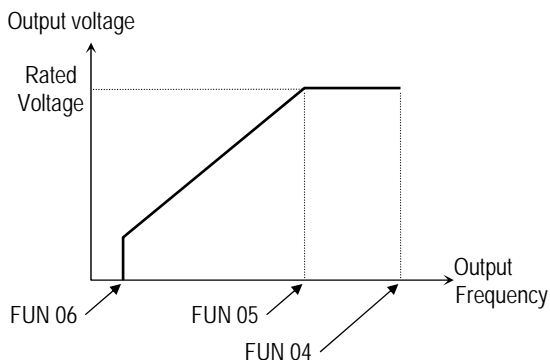

■ **Note:** If maximum frequency is decrease, all frequency parameters are adjusted to the maximum frequency set point.

FUN 07: Hold Time

FUN ► Hold time
07 0.0sec

Setting Range: 0 to 10 sec
Factory Default: 0.0 sec

This function selects the amount of time to hold the starting frequency before accelerating.

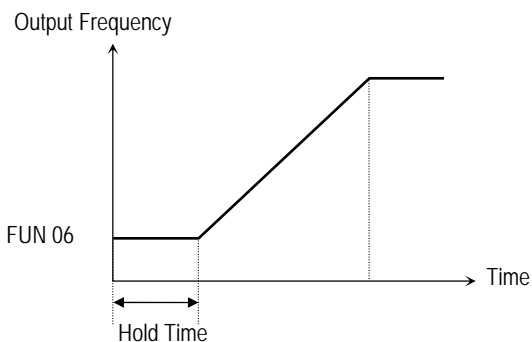

FUN 08: Volts/Hz Pattern

FUN ► V/F pattern
08 Linear

Setting Range: Linear, 2.0, User, Auto
Factory Default: Linear

This is the pattern of voltage/frequency ratio. Select the proper V/F pattern according to the load. The motor torque is dependent on this V/F pattern.

[Linear] pattern is used where constant torque is required. It maintains a linear volts/hertz ratio from zero to base frequency. This pattern is appropriate for conveyer, parking facility etc.

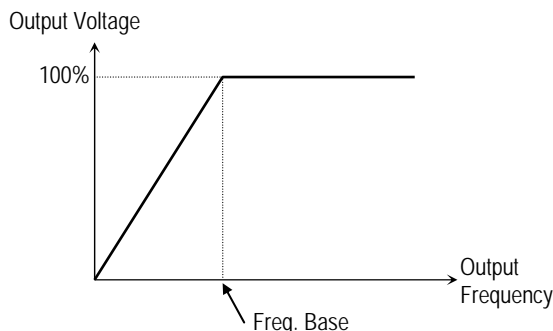

[2.0] pattern is used where variable torque is required. It maintains squared and cube powered ratio characteristics for the volts/hertz ratio. This pattern is appropriate for fans, pumps etc.

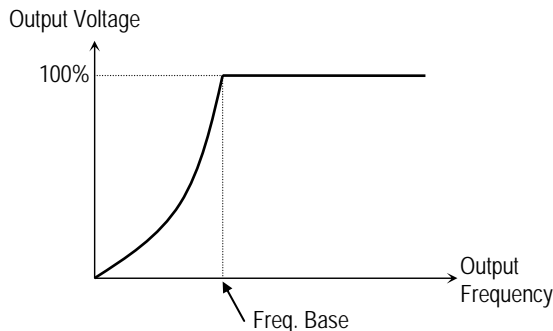

[User] pattern is used for special applications. Users can adjust the volts/hertz ratio according to the application. This is accomplished by setting the voltage and frequency, respectively, at two (2) points between starting frequency and base frequency. The two (2) points of voltage and frequency are set in [FUN 16] through [FUN 19].

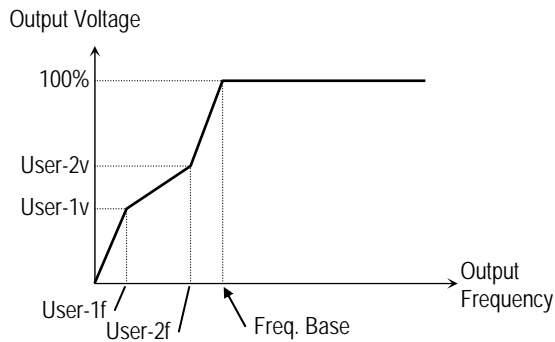

[Auto Boost] pattern is used where high starting torque is applications. This pattern will automatically boost the torque by sensing load current. It has a high torque characteristic at low speed. [Auto] pattern cannot be used when operating several motors with one inverter.

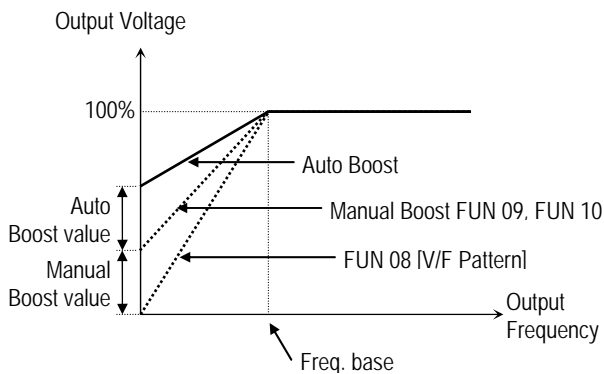

FUN 09: Manual Torque Boost – Forward
FUN 10: Manual Torque Boost - Reverse

FUN ▶ Fwd boost
 09 2 %

Setting Range: 0 to 20 %
 Factory Default: 2 %

FUN ▶ Fwd boost
 10 2 %

Setting Range: 0 to 20 %
 Factory Default: 2 %

[FUN 09] and [FUN 10] establish the level of torque boost in the Forward and Reverse direction. These functions are used to increase the output

voltage to the motor at low speeds for a higher V/F ratio loads that require higher than normal starting torque.

- **Note:** If the torque boost is set higher than needed, it is possible to over-flux or saturate the motor. This can result in the motor overheating.
- **Note:** The manual torque boost value can be added to "Linear" or "2.0" V/F pattern, but not to "User" or "Auto Boost" V/F pattern.

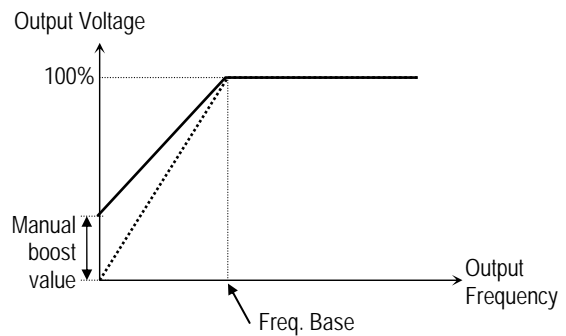

[Linear V/F Pattern: 'Torque Boost']

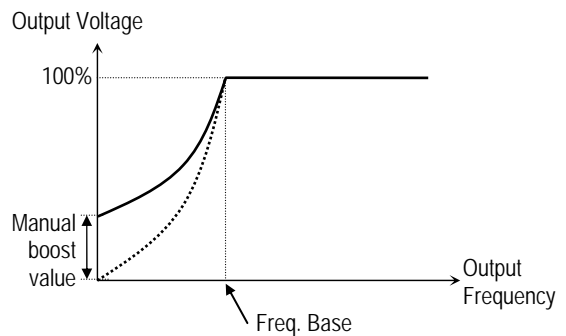

[2.0 V/F Pattern: 'Torque Boost']

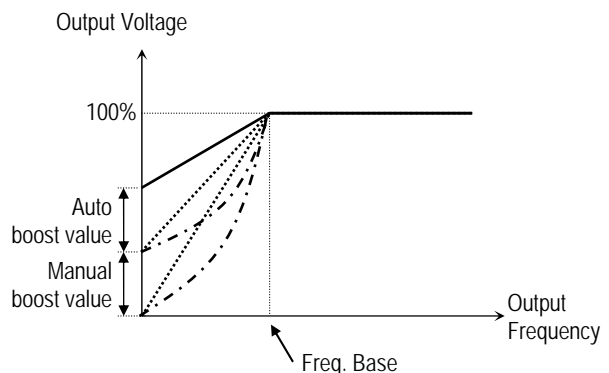

[Auto Boost Pattern: 'Torque Boost']

FUN 11: Acceleration pattern
FUN 12: Deceleration pattern

FUN ▶ Acc. pattern
 11 Linear

FUN ▶ Dec. pattern
 12 Linear

Setting Range: Linear, S-Curve, U-Curve
 Factory Default: Linear

[FUN 11] and [FUN 12] selects different combinations of acceleration and deceleration patterns.

Linear: This is the general acceleration and deceleration pattern for constant torque applications.

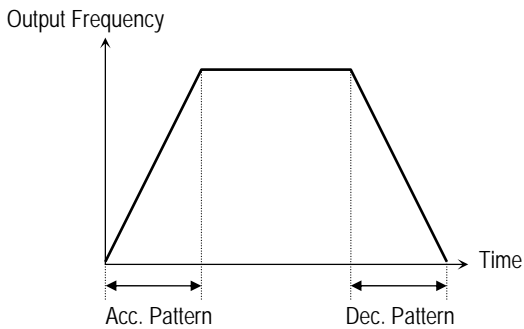

[Acc./Dec. Pattern: 'Linear']

S-Curve: This pattern allows the motor to accelerate and decelerate smoothly. At this time, the actual acceleration and deceleration time are longer about 10% than the acceleration and deceleration time set in DRV 01-02.

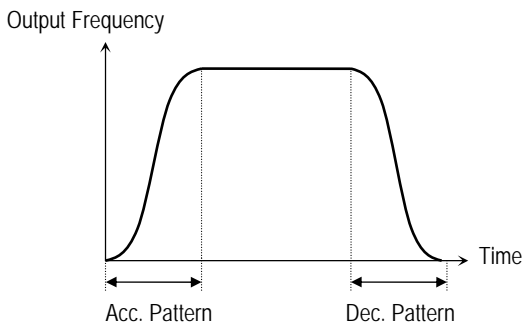

[Acc./Dec. Pattern: 'S-Curve']

U-Curve: This pattern provides more efficient control of acceleration and deceleration in the application like winding machines.

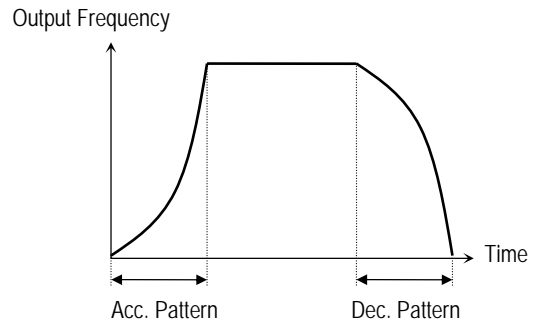

[Acc./Dec. Pattern: 'U-Curve']

FUN 13: Output Voltage Adjustment

FUN ▶ Volt control
 13 100 %

Setting Range: 40 to 110%
 Factory Default: 100%

This function is used to adjust the output voltage of the inverter. This is useful when using a motor with a lower rated voltage than the main input voltage. When this is set at 100%, the inverter outputs its rated voltage.

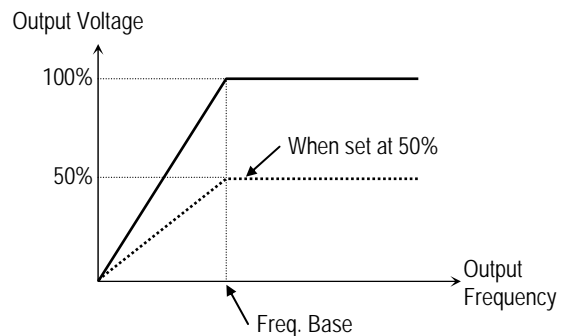

[Output Voltage Adjustment]

FUN 14: Energy Savings Level

FUN ▶ Energy save
14 100 %

Setting Range: 70 to 100%
Factory Default: 100%

This function is used to reduce the output voltage in applications that do not require high torque and current at its steady speed. The inverter reduces its output voltage after accelerating to the reference frequency (steady speed) if the energy save level is set at 80%. This function may cause over-current trip due to the lack of output torque in a fluctuating load.

This function does not work with a 100% set point value.

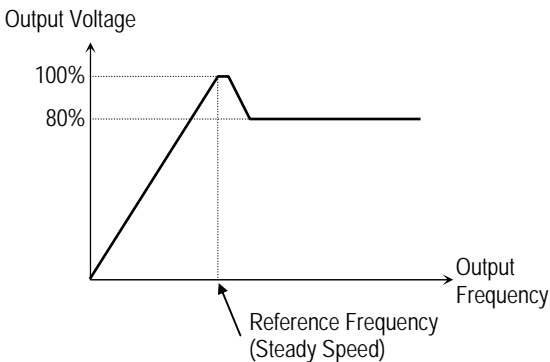

[When Energy Save Level is set at 80%]

FUN 15: Stop Mode Selection

FUN ▶ Stop mode
15 Decel

Setting Range: Decel, DCBR, Free Run
Factory Default: Decel

This function is used to select stopping mode of the motor.

Decel: [Deceleration]

Inverter stops by the deceleration pattern selected in FUN 12 [Dec. pattern].

DCBR: [DC Injection Braking]

Inverter stops with DC injection braking. Inverter outputs DC voltage when the frequency reaches the DC injection braking frequency set in FUN 33 during deceleration.

Free Run: [Coast to Stop]

Inverter cuts off its output immediately when the stop signal is commanded.

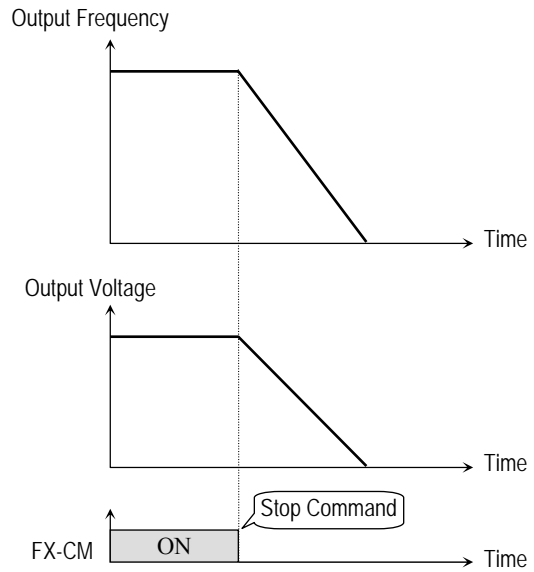

[Stop Mode: 'Decel']

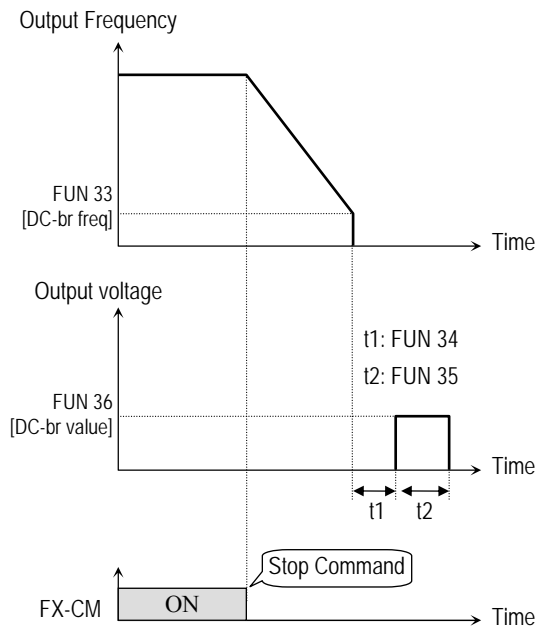

[Stop Mode: 'DCBR']

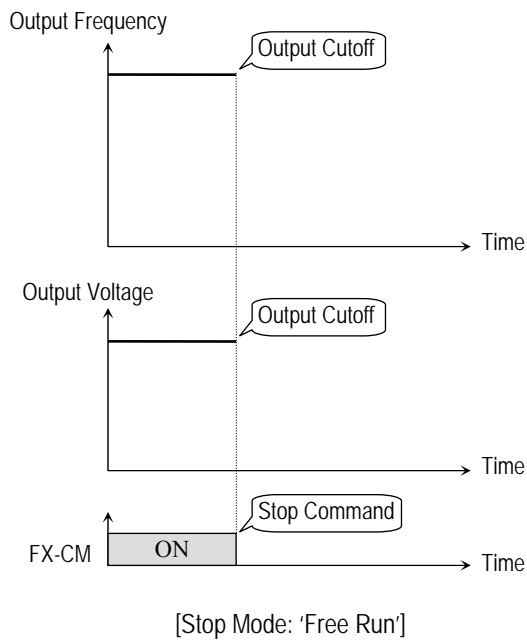

FUN 16 ~ FUN 19: User V/F Pattern

FUN ▶ User-1f
16 10.00 Hz

Setting Range: 0 to 30Hz
Factory Default: 10Hz

FUN ▶ User-1v
17 15%

Setting Range: 0 to 50%
Factory Default: 15%

FUN ▶ User-2f
18 30.00 Hz

Setting Range: FUN 16 to FUN 04
Factory Default: 30Hz

FUN ▶ User-2v
19 50%

Setting Range: FUN 17 to 100%
Factory Default: 50%

These functions are available only when 'User V/F' is selected in FUN 08 [V/F pattern]. Users can make the custom V/F pattern by setting two (2) points between [FUN 06] (Starting Frequency) and [FUN 05] (Base Frequency)

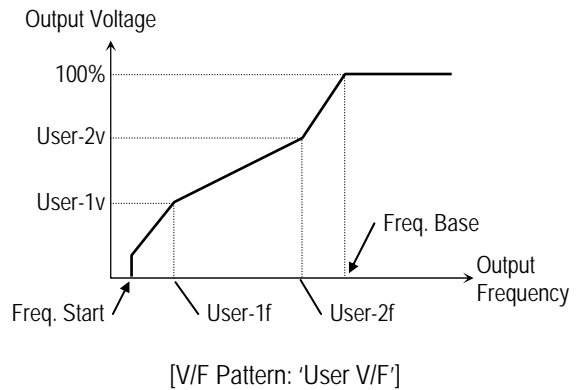

FUN 20: Analog Speed Ref. Selection

FUN ▶ V-I mode
20 V1

Setting Range: V1, I, V1+I, V2
Factory Default: V1

This function is used to set the analog speed command. Use this function when operating from the terminal strip. When using 0~10VDC, 4~20mA input signal or PI control, be sure that [FUN 01] is set for terminal control.

V1: [Voltage 1]

A 0 to 10V DC signal is used for analog speed reference. When using a speed pot, connect it to VR, V1 and CM terminals.

I: [Current]

A 4 to 20mA signal is used for analog speed reference. Connect the current source to I and CM terminals.

V1+I: [Voltage 1+Current]

A 0 to 10V DC and a 4 to 20mA signals are used for analog speed reference at the same time. One signal overrides the other signal.

V2: [Voltage 2]

V2 has the same function as V1.

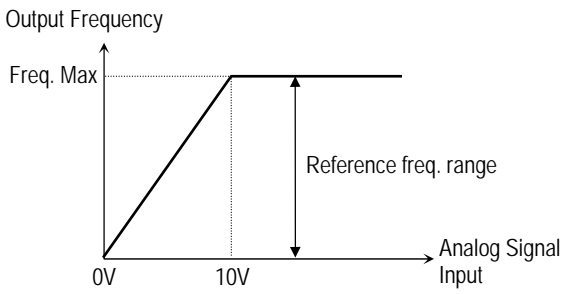

[V-I Mode: 'V1' (Voltage 1)]

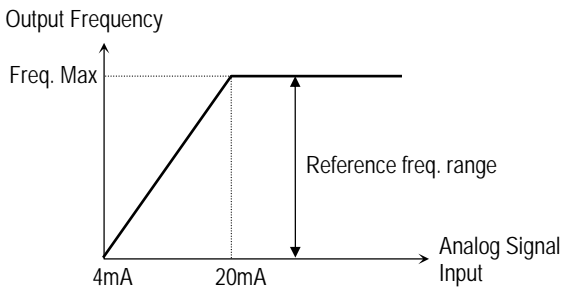

[V-I Mode: 'I' (Current)]

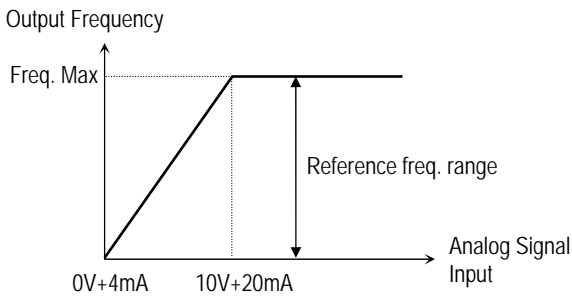

[V-I Mode: 'V1+I' (Voltage 1+Current)]

- **Note:** If the PI control [FUN 62] is selected, the value in [FUN 01] will be ignored. The main speed command is automatically selected as 0~10V with the feedback command being 4~20mA.

FUN 21: Analog Speed Input Filter Gain
 FUN 22: Analog Speed Input Gain
 FUN 23: Analog Speed Input Bias
 FUN 24: Analog Speed Input Direction

FUN ▶ Filter gain
 21 50 %

Setting Range: 1 to 100%
 Factory Default: 50%

This function establishes the response value of the analog speed reference. For a faster response, set the gain lower and vice versa

FUN ▶ Analog gain
 22 100.0 %

Setting Range: 50.0 to 250.0%
 Factory Default: 100.0%

This function is used to determine the analog input scale from a speed potentiometer, 0~10V signal or 4~20mA signal. When this value is set at 50.0%, the inverter outputs maximum frequency at 5V DC or 12mA.

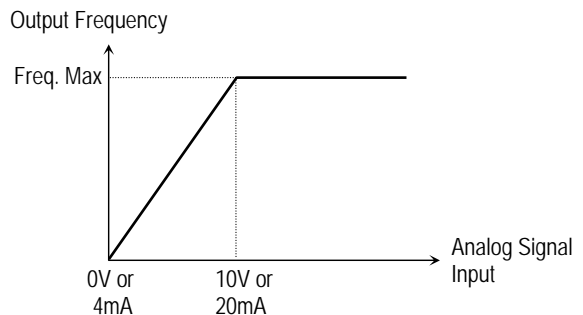

[Analog Gain: '100.0%']

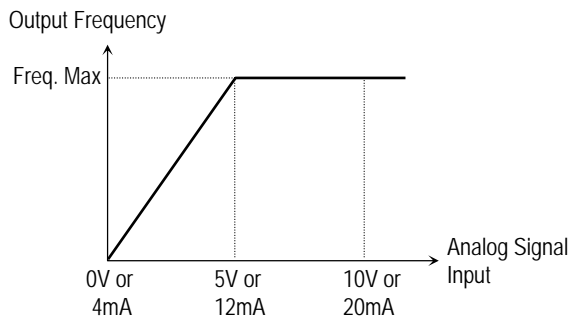

[Analog Gain: '50.0%']

FUN? Analog bias
23 100.0 %

Setting Range: 0.0 to 200.0%
Factory Default: 100.0%

This function is used to give a minimum output signal with a zero analog signal from a manual potentiometer, 0~10V signal or 4~20mA signal.

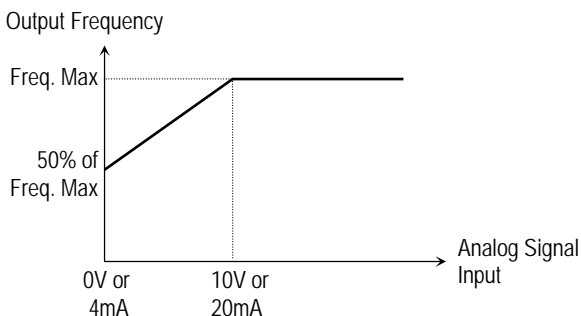

[Analog Bias: '150.0%']

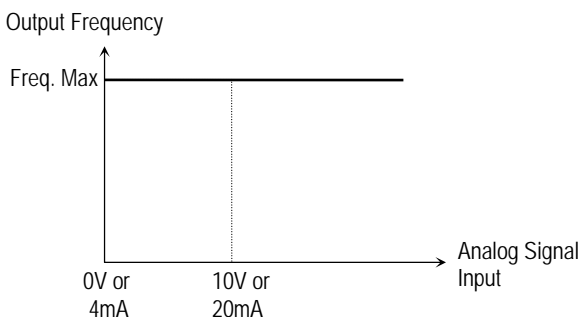

[Analog Bias: '200.0%']

FUN▶ Analog dir
24 Direct

Setting Range: Direct, Invert
Factory Default: Direct

This function creates either a linear relationship between the analog input reference and the analog speed command, or creates an inverted linear relationship between the analog input reference and the analog speed command 0~10V signal or 4~20mA signal.

Direct: The output frequency is directly proportional to the analog signal input.

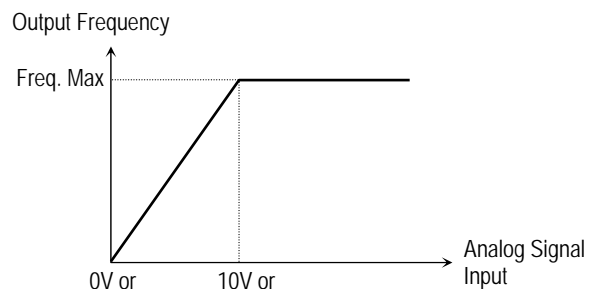

[Analog dir: 'Direct']

Invert: The output frequency is inversely proportional to the analog signal input.

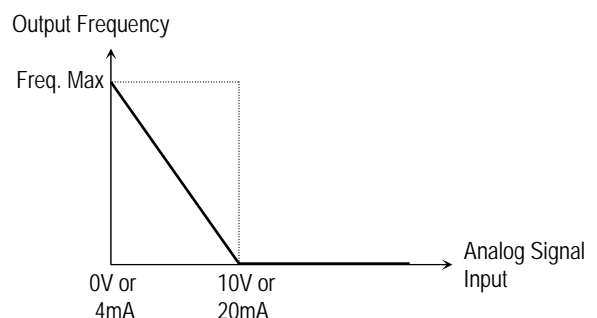

[Analog dir: 'Invert']

FUN 25: Frequency Limit Selection
FUN 26: High Limit Frequency
FUN 27: Low Limit Frequency

FUN ▶ Freq. limit
 25 --- No ---

Setting Range: No, Yes
 Factory Default: No

FUN ▶ F-limit high
 26 60.00 Hz

Setting Range: 0 to FUN 04 [Freq. max]
 Factory Default: 0%

FUN ▶ F-limit low
 27 0.00 Hz

Setting Range: 0 to FUN 26 [F-limit high]
 Factory Default: 0%

[FUN 25] selects the limits for the inverter operating frequency. If [FUN 24] is set to 'Yes', the inverter operates within the upper and lower limit setting. The inverter operates at the upper or the lower limit when the frequency reference is outside the frequency limit range.

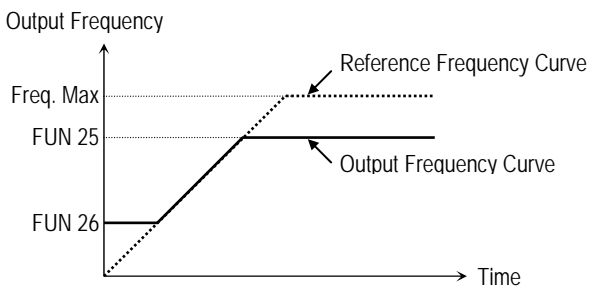

[Freq. limit: 'Yes']

- **Note:** When setting the frequency below the low limit or above the high limit, the drive will automatically ramp inside the limited setting.
- **Note:** When accelerating or decelerating, the output frequency follows the normal acceleration and deceleration rates.

FUN 28: Frequency Jump Selection
FUN 29: Frequency Jump 1
FUN 30: Frequency Jump 2
FUN 31: Frequency Jump 3
FUN 32: Frequency Jump Bandwidth

FUN ▶ Freq. jump
 28 --- No ---

Setting Range: No, Yes
 Factory Default: No

FUN ▶ Freq-jump 1f
 29 10.00 Hz

Setting Range: 0 to FUN 04 [Freq. max]
 Factory Default: 10Hz

FUN ▶ Freq-jump 2f
 30 20.00 Hz

Setting Range: 0 to FUN 04 [Freq. max]
 Factory Default: 20Hz

FUN ▶ Freq-jump 3f
 31 30.00 Hz

Setting Range: 0 to FUN 04 [Freq. max]
 Factory Default: 30Hz

FUN ▶ Freq. band
 32 5.00 Hz

Setting Range: 0 to 30Hz
 Factory Default: 5Hz

To prevent undesirable resonance and vibration on the structure of the machine, this function locks out the resonance frequency from occurring. Each jump frequency also has a bandwidth. This is a span of the particular jump frequency selected. Three different jump frequencies can be set. However, there is only one bandwidth frequency available. This jumping of frequencies does not occur during accelerating or decelerating. It only occurs during continuous operation. To use just one jump frequency, both Frequency jump 1 and

Frequency jump 2 should be set 0 Hz. To use two jump frequencies, Frequency jump 3 should be set 0 Hz.

■ **Note:** When the reference frequency is set inside the jump frequency, the output frequency goes to the frequency marked by "●" symbol.

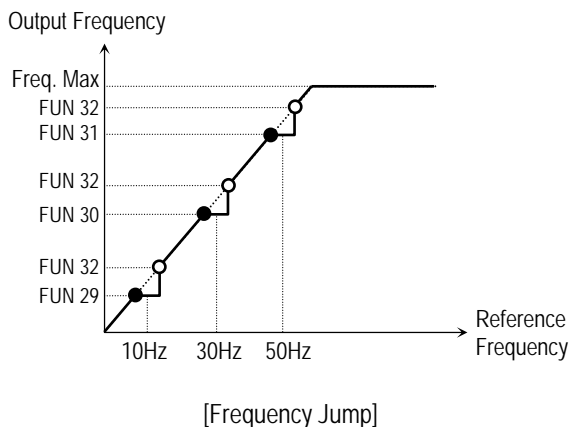

FUN 33: DC Injection Braking Frequency
FUN 34: DC Injection Braking On-Delay Time
FUN 35: DC Injection Braking Time
FUN 36: DC Injection Braking Voltage

FUN ▶ DC-br freq
 33 0.5 Hz

Setting Range: 0 to 60Hz
 Factory Default: 0.5Hz

FUN ▶ DC-br block
 34 2.0 sec

Setting Range: 0.5 to 5 sec
 Factory Default: 2.0sec

FUN ▶ DC-br time
 35 0.5 sec

Setting Range: 0.1 to 25 sec
 Factory Default: 0.5sec

FUN ▶ DC-br value
 36 1 %

Setting Range: 1 to 20 %
 Factory Default: 1%

The DC injection braking function is enabled in FUN 15 [Stop mode]. By introducing a DC voltage to the motor windings, this function stops the motor immediately.

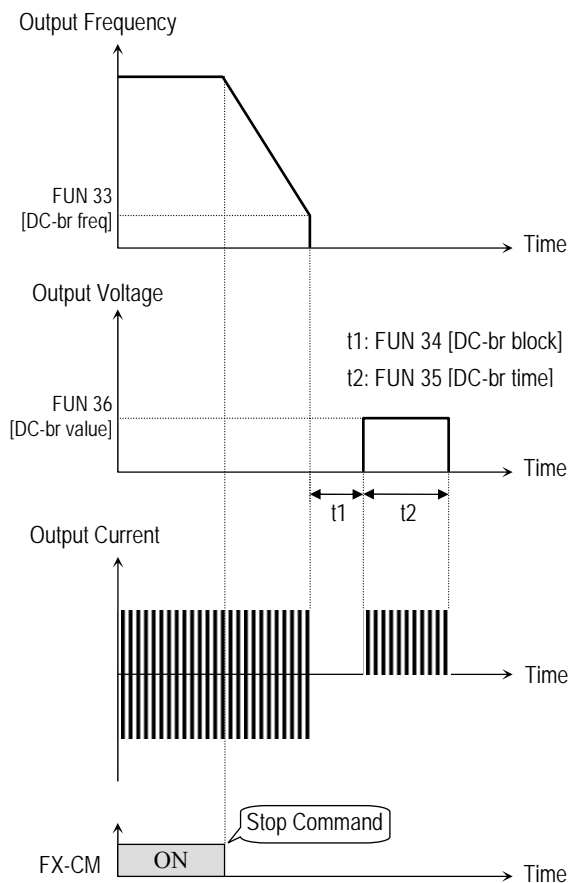

[DC Injection Braking with 'Stop mode: DCBR']

■ **Note:** The on-delay time must be set according to the DC injection braking frequency and the magnitude of the load. If the on-delay time is set 0 sec, the drive may trip on over current. This is because the DC voltage flows before the motor's magnetic field and voltage have decayed.

[FUN 33] (DC Injection Braking Frequency) is the frequency at which the inverter starts to output DC voltage during deceleration.

[FUN 34] (DC Injection Braking On-Delay Time) is the inverter output blocking time before DC injection braking.

[FUN 35] (DC Injection Braking Time) is the time the DC current is applied to the motor.

[FUN 36] (DC Injection Braking Voltage) is the DC voltage applied to the motor and is based upon rated inverter output voltage.

FUN 37: Slip Compensation
FUN 38: Rated Slip of Motor
FUN 39: Rated Current of Motor
FUN 40: No Load Current of Motor

FUN▶ Slip compen.
 37 --- No ---

Setting Range: No, Yes
 Factory Default: No

FUN▶ Rated slip
 38 0.00 Hz

Setting Range: 0 to 5Hz
 Factory Default: 0Hz

FUN▶ M-rated cur.
 39 122.0 A

Setting Range: 0.1 to 999A
 Factory Default: depend on [FUN 41]

FUN▶ No-load cur.
 40 0.1 A

Setting Range: 0.1 to 300A
 Factory Default: 4.0A

This function is used to maintain the motor speed constantly. To keep the motor speed constant, the output frequency varies within the limit of slip frequency-FUN 38 [Rated slip] according to the load current. For example, when the motor speed decreases below the reference speed (frequency) due to a heavy load, the inverter increases the output frequency higher than the reference frequency to increase the motor speed. The inverter increases or decreases the output by delta frequency shown below.

$$\text{Delta Freq.} = \frac{\text{Output Current} - \text{No-load Current}}{\text{Rated Current} - \text{No-load Current}} \times \text{Rated Slip}$$

Output frequency = Reference freq. + Delta freq.

FUN 41: Inverter Capacity

FUN▶ Inv Capacity
 41 SV030iH-2U

Setting Range: SV030iH-2U ~ SV375iH-4U
 Factory Default: depend on model number

Description:

[FUN 41] selects the inverter capacity. Inverter capacity must be set correctly for proper current calculation and protective functions.

FUN 42: Auto Restart
FUN 43: Restart On-Delay Time

FUN▶ Retry number
 42 0

Setting Range: 0 to 10
 Factory Default: 0

FUN▶ Retry time
 43 1.0sec

Setting Range: 0 to 10 sec
 Factory Default: 1sec

[FUN 41] establishes the number of times the inverter will try to restart itself after an over current, over voltage, ground fault, or over current limit occurs. This function uses the Speed Search function. See [FUN 56] through [FUN 58]. [FUN 42] establishes the amount of wait time between Auto-Restart attempts. When an under voltage fault, M/C Fail or inverter disable (BX) occurs, the drive does not restart automatically.

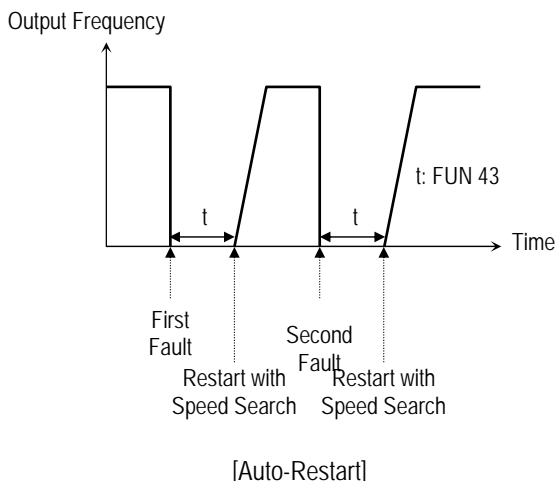

- Note: Inverter decreases the retry number by ones as a fault occurs. When restarted without a fault during 30 seconds, the inverter increases the retry number by ones.

FUN 44: Fault Output Relay (A, B, C)

FUN ▶ Relay mode
44 Retry 0

Setting Range: Retry 0, All Trips, LV+Retry 0, LV+All Trips
Factory Default: Retry 0

[FUN 44] determines the operation of the fault relay after a fault has occurred. The output relay terminals are A, B, C on control terminal strip.

Retry 0: The output relay operates when the retry number decreases to 0 by faults. When the retry number is set to 0 by default, the relay operates at any faults **except** at under voltage, M/C Fail and BX (inverter disable) fault.

All Trips: The output relay operates on all faults **except** under voltage, M/C Fail and BX (inverter disable) fault. The output relay operates regardless of the retry number.

LV+Retry 0: In case of an under voltage fault, M/C Fail or a 0 restart count, the output relay operates. For a BX (inverter disable) input, the relay does NOT operate.

LV+All Trips: When a fault including under voltage or M/C Fail occurs, the output relay operates. In BX (inverter disable), the relay does NOT operate. The output relay operates regardless of the retry number.

FUN 45: Stall Prevention
FUN 46: Stall Prevention Level

FUN ▶ Stall mode
45 None

Setting Range: None, Acc, Steady, Acc+Steady, Dec, Acc+Dec, Dec+Steady, Acc+Dec+Std
Factory Default: None

FUN ▶ Stall level
46 150 %

Setting Range: CT : 30 to 150% VT : 30 to 110%
Factory Default: 150% 110%

[FUN 45] is used to prevent the motor from stalling by reducing the inverter output frequency until the motor current decreases below the stall prevention level.

[FUN 46] assigns the stall prevention level in percent of motor FLA.

Acc: During acceleration, when the output current of the inverter reaches the stall prevention level, the drive reduces its output frequency. When the current reduces below the stall prevention level, the drive will begin to accelerate again.

Steady: During steady state, when the output current of the inverter reaches the stall prevention level, the drive reduces its output frequency. When the current is reduced below the stall prevention level, the drive returns to its command frequency.

Dec: During deceleration, when the output current of the inverter reaches the stall prevention level, the drive reduces its output frequency. When the current reduces below the stall prevention level, the drive will begin to decelerate again.

Acc+Steady: Stall prevention is active during acceleration and steady state operation.

Acc+Dec: Stall prevention is active during acceleration and deceleration.

Dec+Steady: Stall prevention is active during deceleration and steady state operation.

Acc+Dec+Std: Stall prevention is active during acceleration, deceleration and steady state operation.

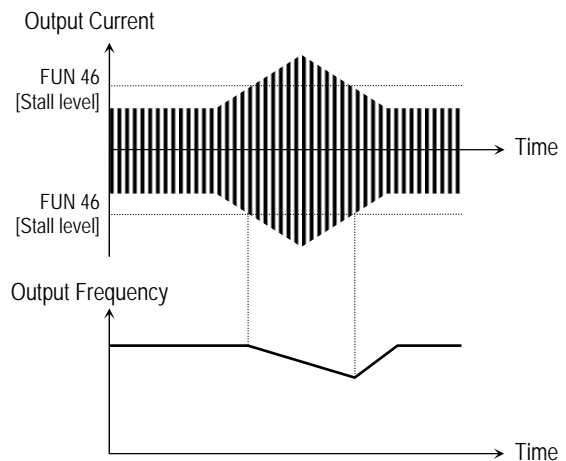
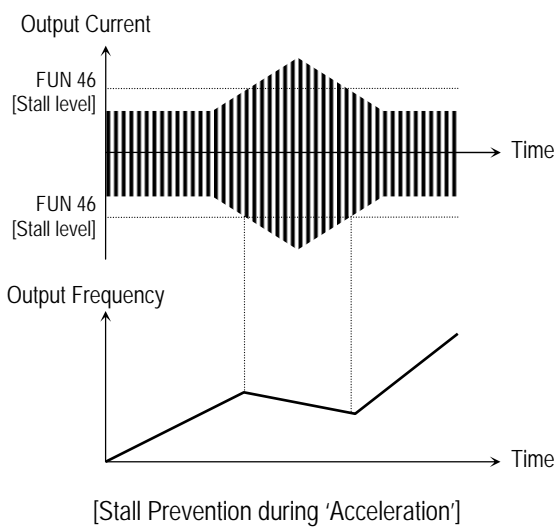

[Stall Prevention during 'Steady']

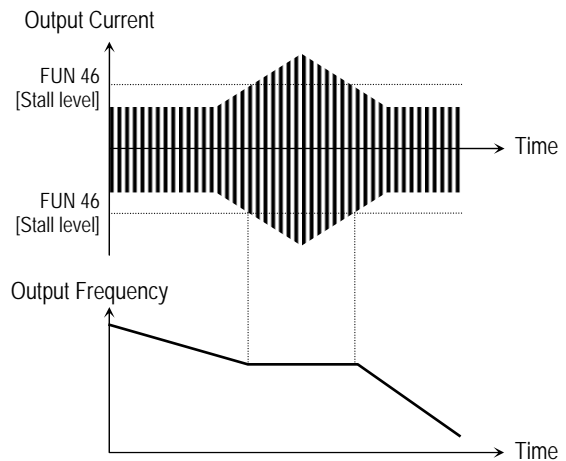

[Stall Prevention during 'Deceleration']

FUN 47: Overload Warning Level
FUN 48: Overload Warning On-Delay Time

FUN ▶ OL level
 47 150 %

Setting Range: CT : 30 to 150% VT : 30 to 110%
 Factory Default: 150% 110%

FUN ▶ OL time
 48 10.0sec

Setting Range: 1 to 30 sec
 Factory Default: 10sec

[FUN 47] is used to provide motor overload detection. When the output current of the inverter has reached the “Overload Warning Level” and

after the [FUN 48] on-delay time has been reached, a multi-output signal may be turned on.

For example, define multi-output OC1 in [I/O 07 ~ 09] (OC1 Output) to OL. The multi-output is open collector (24V DC, 50mA).

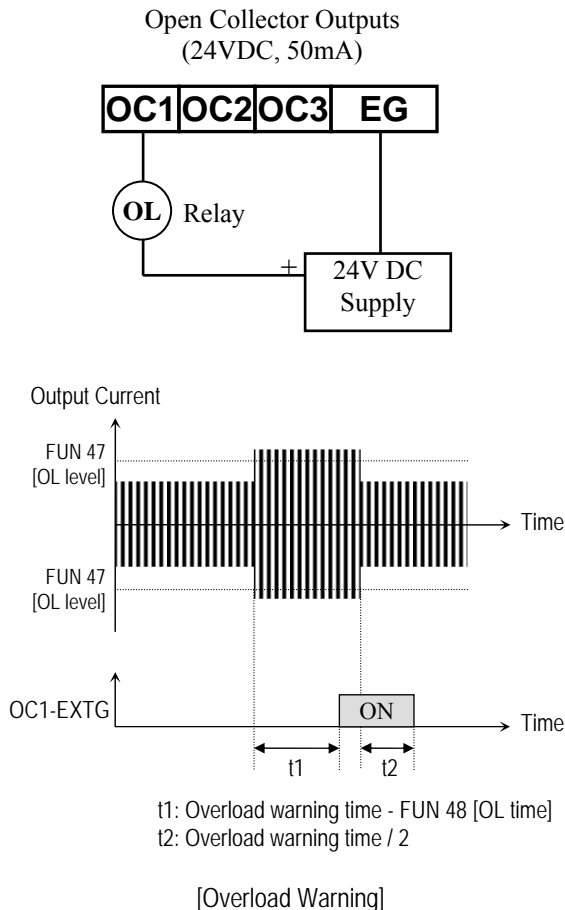

FUN 49: Over Current-Limit Trip Level
FUN 50: Over Current-Limit Trip Time

FUN ▶ OC lim level
49 160 %

Setting Range: CT: 30 to 200% VT: 30 to 150%
Factory Default: 160% 110%

FUN ▶ OC lim. time
50 60.0sec

Setting Range: 0 to 60sec
Factory Default: 60sec

[FUN 49] and [FUN 50] turn off the output current or the inverter when the motor reaches Over Current-Limit Trip Level and has timed out. These functions protect against abnormal load conditions.

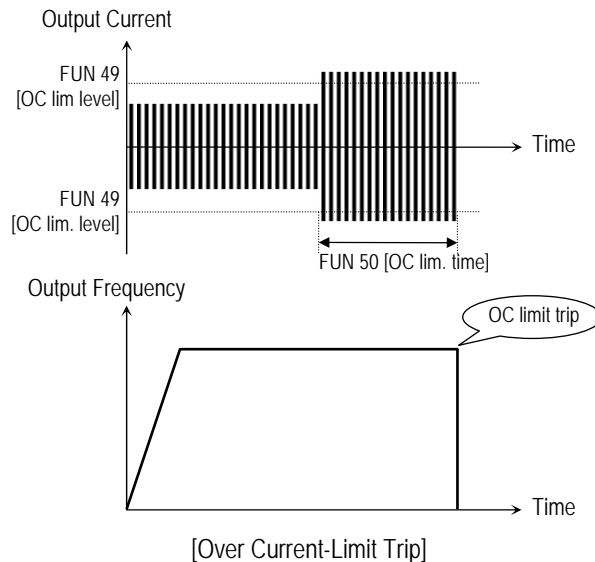

FUN 51: Electronic Thermal (ETH) Selection
FUN 52: Electronic Thermal Level
FUN 53: Motor Type

FUN ▶ ETH select
51 --- No ---

Setting Range: No, Yes
Factory Default: No

FUN ▶ ETH level
52 150 %

Setting Range: 30 to 150%
Factory Default: 150%

FUN ▶ Motor type
53 General

Setting Range: General, Special
Factory Default: General

These functions are to protect the motor from overheating without using additional thermal overload relay. Inverter calculates the temperature rising of the motor using several parameters and determines whether or not the motor is overheated.

FUN 55: IPF Restart Selection
FUN 56: Speed Search Acceleration Time
FUN 57: Speed Search Deceleration Time
FUN 58: Speed Search Gain

FUN▶ IPF select
 55 --- No ---

Setting Range: No, Yes
 Factory Default: No

FUN▶ ss acc. time
 56 5.0sec

Setting Range: 0.1 to 600sec
 Factory Default: 5sec

FUN▶ ss dec. time
 57 10.0sec

Setting Range: 0.1 to 600sec
 Factory Default: 10sec

FUN▶ ss gain
 58 100 %

Setting Range: 0 to 200%
 Factory Default: 100%

These functions are used to permit automatic restarting after Instantaneous Power Failure without waiting for the motor to stop.

- [FUN 55] selects the 'IPF Restart' function
- [FUN 56] determines the acceleration time during speed search.
- [FUN 57] determines the deceleration time during speed search.
- [FUN 58] determines the gain during speed search.

- The speed search gain and Acc/Dec time should be set after considering the inertia moment (GD^2) and magnitude of the load.

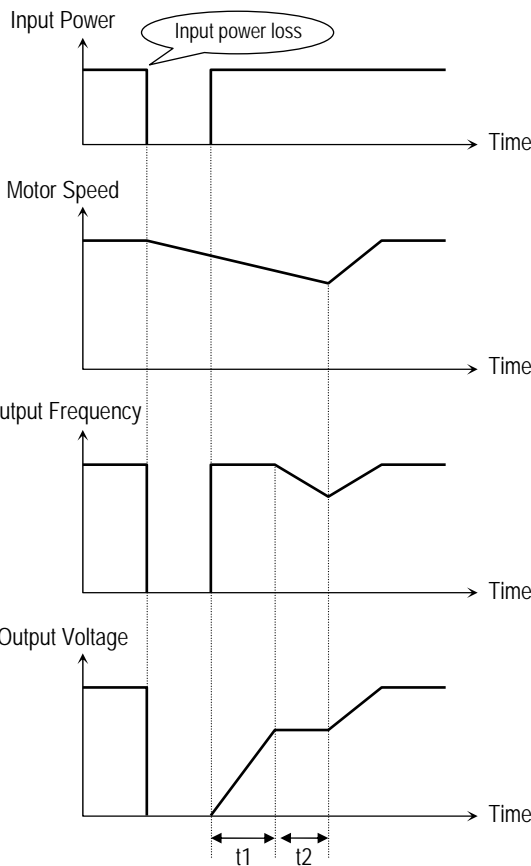

t1: FUN 56 [ss acc. time]
 t2: FUN 57 [ss dec. time]

[IPF Restart and Speed Search]

FUN 59: Restart After Fault Reset Selection

FUN▶ RST-restart
 59 --- No ---

Setting Range: No, Yes
 Factory Default: No

If [FUN 59] is set to 'Yes', inverter will restart after the RST (reset) terminal has been reset. If [FUN 59] is set to 'No', restart the inverter by cycling the FX terminal to CM terminal after the fault has been reset. If the motor is rotating at the time power is restored. The inverter may trip. To avoid this trip, use 'Speed Search' function.

- Note: When selecting 'Reset Restart' to 'Yes', make sure to utilize appropriate warning notice to minimize the potential for injury or equipment damage.

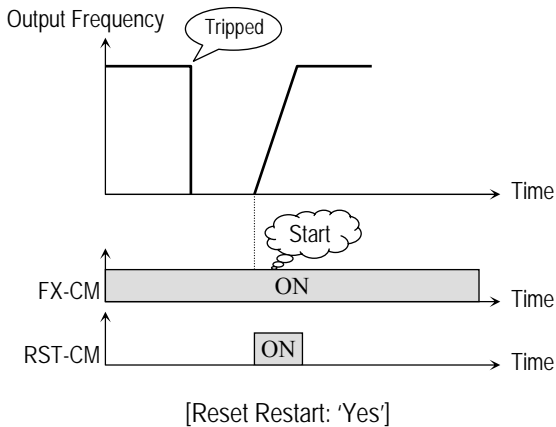
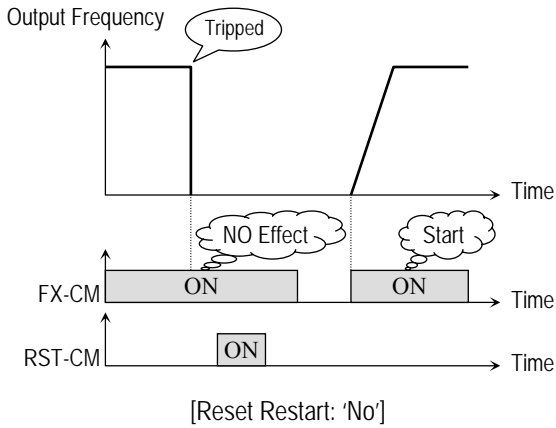

FUN 60: Restart After Power-On Selection

```
FUN▶ Power on st
60 --- No ---
```

Setting Range: No, Yes
 Factory Default: No

If [FUN 60] is set to 'Yes', inverter will restart after input power has been restored. If [FUN 60] is set to 'No', restart the inverter by cycling the FX terminal after the fault has been reset. If the motor is rotating at the time power is restored. The inverter may trip. To avoid this trip, use 'Speed Search' function.

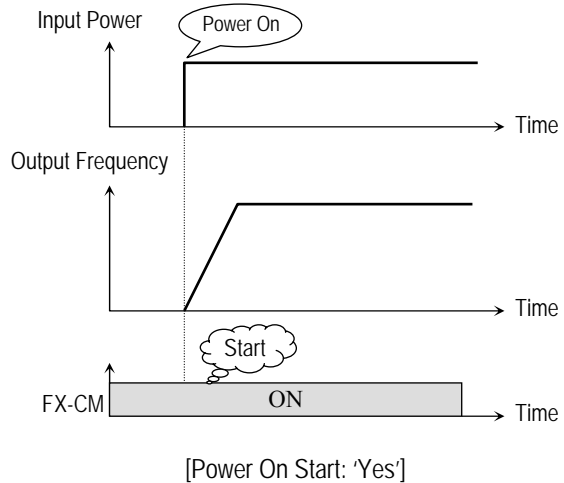
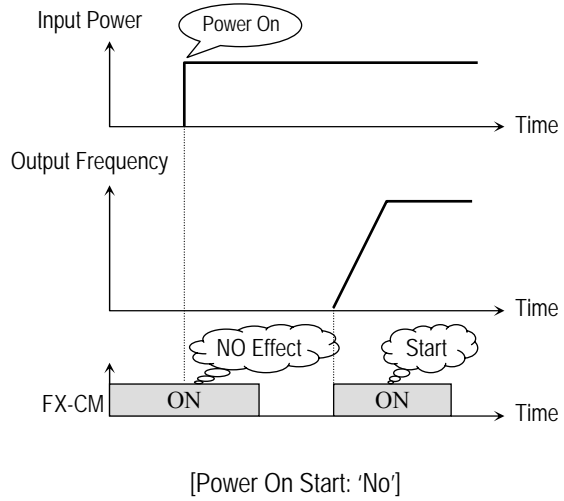

- Note: When selecting 'Power-On Start' to 'Yes', make sure to utilize appropriate warning notice to minimize the potential for injury or equipment damage.

FUN 61: Carrier frequency

```
FUN▶ Carrier Freq
61 6 kHz
```

Setting Range: See [FUN 61] in 'Parameter List'
 Factory Default: 6kHz

This parameter affects the audible sound of the motor, emission from the inverter, inverter temperature, and leakage current. If the ambient temperature where the inverter installed is high or other equipment may be affected by potential inverter noise, set this value lower.

This is also used to avoid induced resonance in the machine or motor.

- FUN 62: PI Control Selection
- FUN 63: Proportional Gain
- FUN 64: Integral Gain
- FUN 65: PI Feedback Signal Selection
- FUN 66: PI Feedback Filtering Gain
- FUN 67: PI Feedback Gain
- FUN 68: PI Feedback Bias
- FUN 69: PI Feedback Direction
- FUN 70: I-Term Scale
- FUN 71: PI Error Direction
- FUN 72: PI Control Bypass

For HVAC or Pump applications, the PID control can be used to adjust the actual output by comparing a feedback with a 'Set-point' given to the inverter. This 'Set-point' can be in the form of Speed, Temperature, Pressure, Flow level, etc. The 'Set-point' and the feedback signals are provided externally to the inverter analog input terminals V1, V2 or I. The inverter compares the signals in calculating 'total-error' which is reflected in the inverter output.

FUN ▶ PI-control
62 --- No ---

Setting Range: No, Yes
Factory Default: No

This parameter selects PI control.

FUN ▶ P-gain
63 10

Setting Range: 1 to 30,000
Factory Default: 10

Sets the proportional gain for PI control.

FUN ▶ I-gain
64 50

Setting Range: 1 to 30,000
Factory Default: 50

Sets the integral gain for PI control.

FUN ▶ PI-FB select
65 I

Setting Range: I, V1, V2
Factory Default: I

Selects the feedback signal for PI control.

FUN ▶ PI-FB fit.G
66 25%

Setting Range: 1 to 100%
Factory Default: 25%

Selects the filtering gain for feedback signal.

FUN ▶ PI-FB gain
67 100%

Setting Range: 50 to 250%
Factory Default: 100%

Selects the gain for feedback signal.

FUN ▶ PI-FB bias
68 100%

Setting Range: 0 to 200%
Factory Default: 100%

Selects the bias for feedback signal.

FUN ▶ PI-FB dir
69 Direct

Setting Range: Direct, Invert
Factory Default: Direct

Selects the direction of feedback signal.

FUN ▶ I_term scale
70 100%

Setting Range: 0 to 100%
Factory Default: 100%

Used to scale [FUN 64].

FUN ▶ PI error dir
71 Direct

Setting Range: Direct, Invert
Factory Default: Direct

Used to change the polarity of error (command – feedback).

FUN▶ Regul bypass
72 --- No ---

Setting Range: No, Yes
Factory Default: No

PI bypass function is activated when Optional MMC card is installed. When selected to ‘Yes’, inverter bypasses PI control and operates with frequency reference of feedback.

FUN 94: CT/VT Mode Selection

FUN▶ CT/VT
94 Constant Trq

Setting Range: Constant Trq, Variable Trq
Factory Default: Constant Trq

This parameter selects ‘Constant Torque’ or ‘Variable Torque’. If ‘Variable Torque’ is selected, All current related parameters are changed to VT rating. (Overload Capacity, Carrier Frequency, Stall Prevention Level, Overload Warning Level, and Over Current-Limit Trip Level).

- Note: [FUN 94] must be changed only qualified personnel by LSIS.

FUN 95: Parameter Upload to Keypad

FUN▶ Para. read
95 --- No ---

Setting Range: No, Yes
Factory Default: No

This parameter is used to copy all parameters from the inverter to the keypad.

FUN 96: Parameter Download to Inverter

FUN▶ Para. write
96 --- No ---

Setting Range: No, Yes
Factory Default: No

This parameter is used to copy all parameters from the keypad to the inverter.

FUN 97: Initialize Parameters to Factory Setting

FUN▶ Para. init
97 --- No ---

Setting Range: No, Yes
Factory Default: No

This parameter returns all of the inverter parameters to their original settings.

- Note: Initializing the parameters to factory default settings also initializes the Inverter Capacity parameter [FUN 41]. Once the parameters are initialized to their factory defaults, [FUN 41] must be set to its proper model number.

FUN 98: Parameter Lockout

FUN▶ Para. lock
98 0

Setting Range: 0 to 255
Factory Default: 0

This function will prevent changes from being made to the parameters set in the drive. When the parameters are locked, the display arrow changes from solid to dashed line. The lock and unlock code is ‘12’.

5.3 I/O Group

I/O 00: Jump to Desired Code

I/O ► Jump Code
00 1

Setting Range: 1 to 65
Factory Default: 1

Jumping directly to any program code can be accomplished by entering the desired code number.

I/O 01 - 06: Multi-Function Inputs (Terminals P1 ~ P6)

I/O ► P1 Input
01 SPD_L

Factory Default: SPD_L

I/O ► P2 Input
02 SPD_M

Factory Default: SPD_M

I/O ► P3 Input
03 SPD_H

Factory Default: SPD_H

I/O ► P4 Input
04 ACCT_L

Factory Default: ACCT_L

I/O ► P5 Input
05 ACCT_M

Factory Default: ACCT_M

I/O ► P6 Input
06 ACCT_H

Factory Default: ACCT_H

Multi-function input terminals can be defined for many different applications. The following table shows various definitions for them.

Setting Range	Description
SPD_L SPD_M SPD_H	Multi-Step Speed via P1-P6
JOG	Jog
ACCT_L ACCT_M ACCT_H	Multi-Accel/Decel Time Select
UP	Increase Drive Output Frequency
DOWN	Decrease Drive Output Frequency
HOLD	Hold Drive Output Frequency
DIS_OPT	Disable Option Control
COMM_CONN	Connect Motor to Commercial Line
EXT_DCBR	Initiate Dynamic Braking Mode
EXT_TRIP	Initiate External Fault
INTERLOCK	Used for MMC Option

SPD_L, SPD_M, SPD_H: [Multi-Step Speed]

By setting P1, P2 and P3 terminals to 'SPD_L', 'SPD_M', and 'SPD_H' respectively, the inverter can operate at the preset frequency set in [I/O 13] through [I/O 19].

The preset frequencies are determined by the combination of P1, P2 and P3 terminals as shown in the following table.

Multi-Step Speed Selection Table

	Speed 0	Speed 1	Speed 2	Speed 3	Speed 4	Speed 5	Speed 6	Speed 7
SPD_L	0	1	0	1	0	1	0	1
SPD_M	0	0	1	1	0	0	1	1
SPD_H	0	0	0	0	1	1	1	1

0: OFF, 1: ON

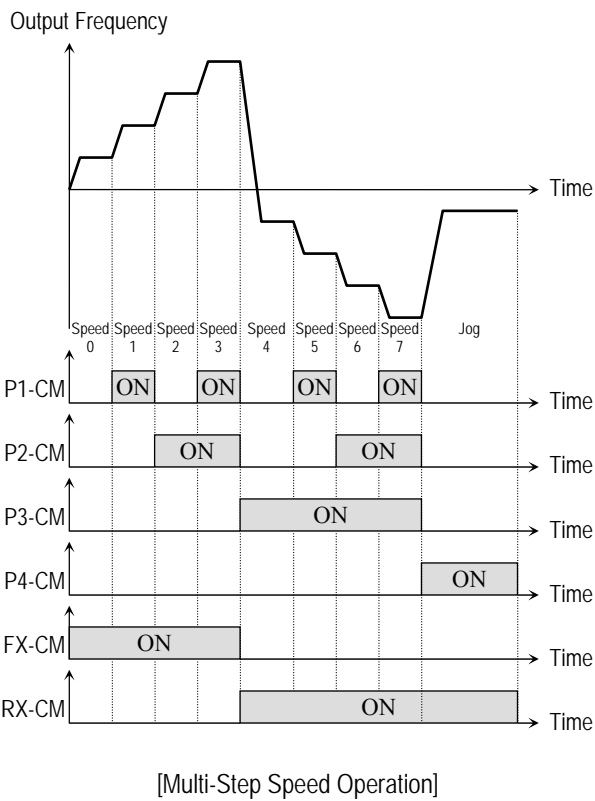

- **Note:** [I/O 12] (Jog Frequency) can be used as one of the step frequencies.
- **Note:** If the 'Jog' terminal is ON, inverter operates at the Jog frequency regardless of other terminal inputs.

JOG:

Jog Frequency can be used as one of the step frequencies. Jog frequency is set in I/O 12.

ACCT_L, ACCT_M, ACCT_H:

[Multi-Step Acceleration/Deceleration Time]

By setting multi-function input terminals to 'ACCT_L', 'ACCT_M' and 'ACCT_H' respectively, up to 7 different Accel and Decel times can be used. The Accel/Decel time is set in [I/O 20] through [I/O 33]

The Accel/Decel time is determined by the combination of multi-function input terminals as shown in the following table.

Multi-Step Accel/Decel Time Selection Table

	Time 0	Time 1	Time 2	Time 3	Time 4	Time 5	Time 6	Time 7
ACCT_L	0	1	0	1	0	1	0	1
ACCT_M	0	0	1	1	0	0	1	1
ACCT_H	0	0	0	0	1	1	1	1

0: OFF, 1: ON

The Time 0 Accel/Decel time is configured by DRV 01-02 and selected when no Accel/Decel input terminals are active.

Example:

If P4 is configured as ACC_L, P5 as ACCT_M and P6 as ACCT_H, then P4, P5 and P6 terminals can select the transition time.

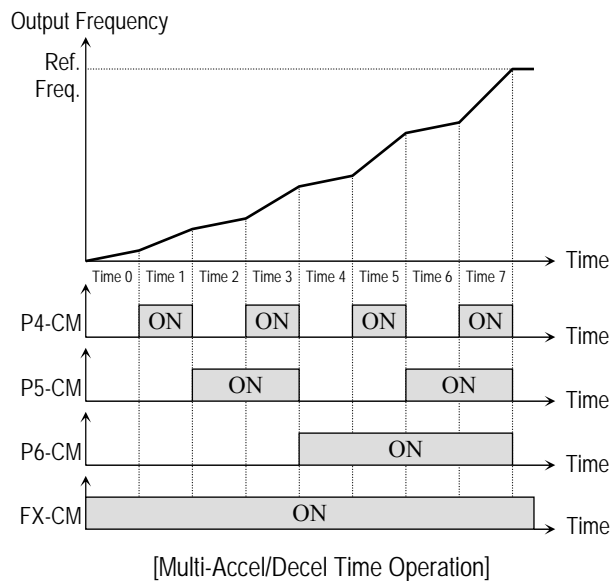

UP, DOWN:

By using the Up and Down function, the drive can accelerate to a steady speed and decelerate down to a desired speed by using only two input terminals.

Example:

If P1 is configured as 'UP' and P2 as 'DOWN', then Up/Down operation can be achieved using P1 and P2 terminals.

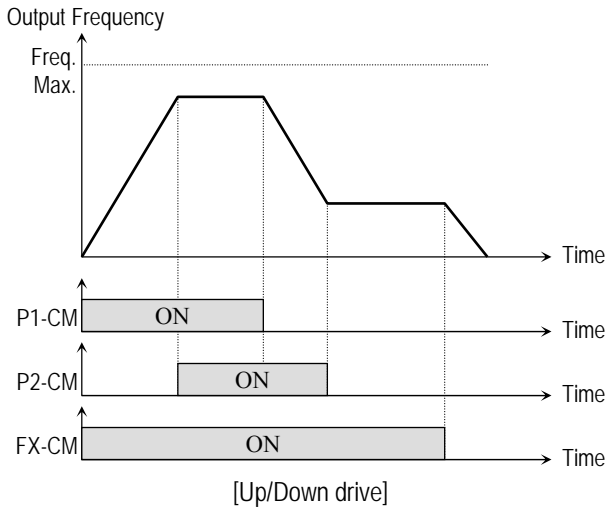

HOLD:

This function is for 3-wire start/stop control. This parameter is mainly used as a momentary push button to hold the current frequency output during acceleration or deceleration.

Example:

When P2 is configured as 'HOLD'.

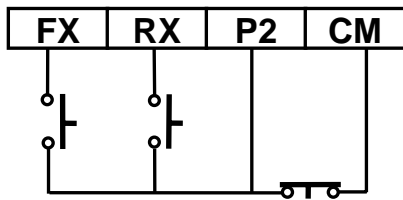

[Wiring for 3-Wire Operation]

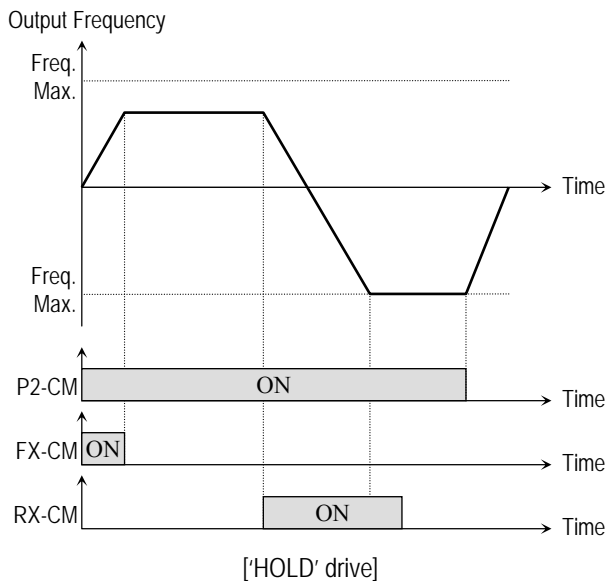

DIS_OPT: This function is used to exchange control mode from Option Board to Inverter.

COMM_CONN:

This function is used to bypass the motor from the inverter to commercial power, or the opposite. To bypass the motor to commercial line, set [FUN 01] to either 'Key' or 'Terminal'. Set the Run and Stop method to 'Terminal-1' in [FUN 02]. Configure P5 as 'COMM_CONN' in [I/O 10]. To bypass the motor input from the inverter, close the P5 terminal to CM.

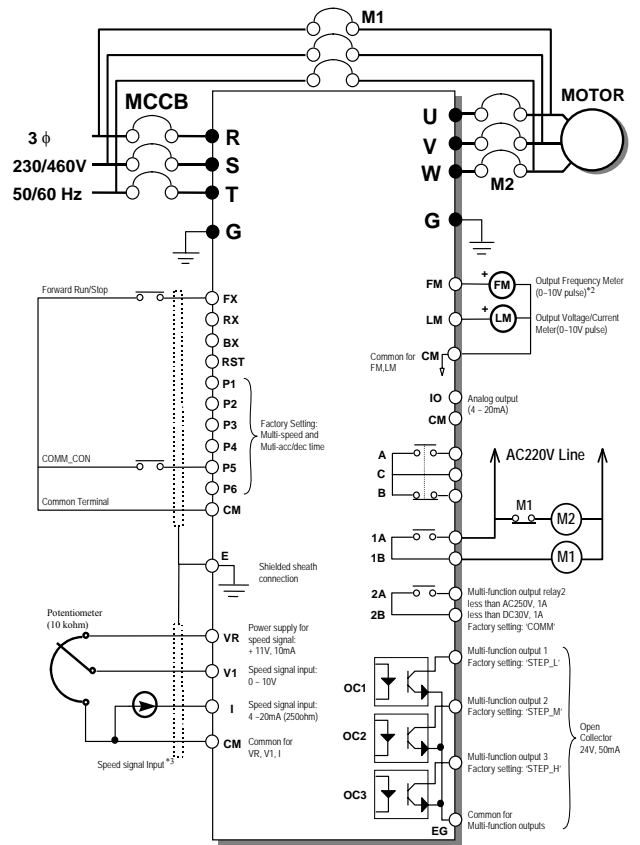

[Wiring for 'COMM_CONN']

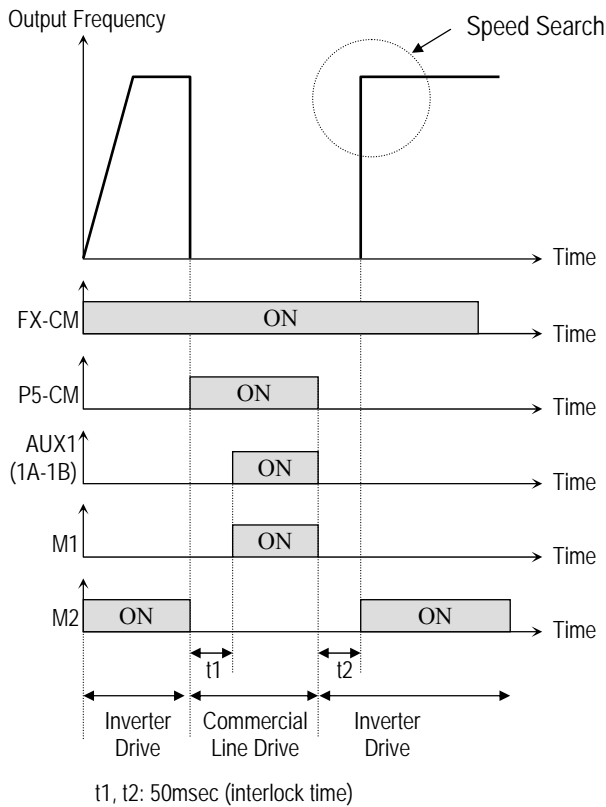

[‘COMM_CONN’ Sequence]

EXT_DCBR:

DC Injection Braking can be activated, while the inverter is stopped, by configuring one of the multi-function input terminals to ‘EXT_DCBR’. To activate the DC Injection Braking, close the contact on the assigned terminal while the inverter is stopped.

Example:

If P4 is configured as EXT_DCBR, then DC injection braking is achieved on stop by using P4 input terminal.

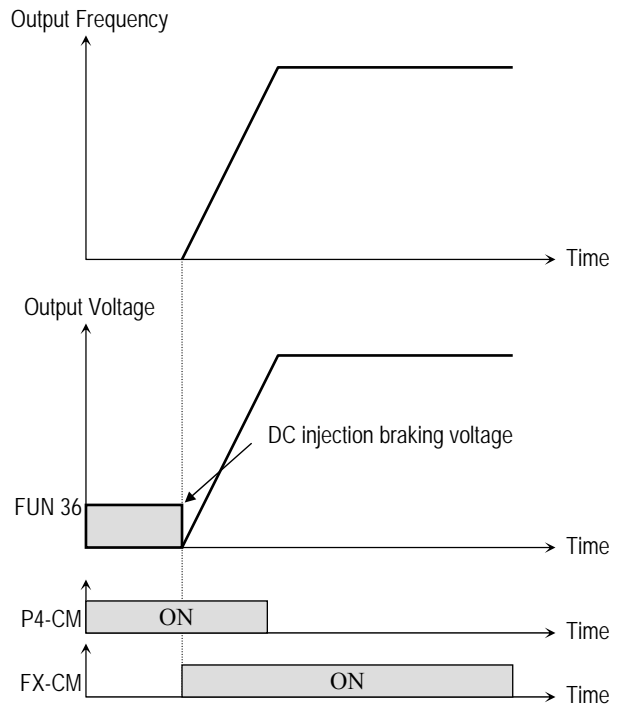

[External DC-braking in stop]

EXT_TRIP:

This is a normally closed contact input. When an input terminal is set to ‘EXT_TRIP’ and the contact input opens, the inverter displays the fault and cuts off its output. This can be used as an external latch trip. The inverter will decelerate as configured in [FUN 15]. The inverter must be RESET and the RUN command must be re-initiated to restart the drive.

I/O 07 - 11: Multi-function Outputs (OC1, OC2, OC3, AUX1, AUX2)

I/O ► OC1 output
07 STEP_L

Factory Default: STEP_L

I/O ► OC2 output
08 STEP_M

Factory Default: STEP_M

I/O ► OC3 output
09 STEP_H

Factory Default: STEP_H

I/O ► AUX1 output
10 COMM

Factory Default: COMM

I/O ► AUX2 output
11 COMM

Factory Default: COMM

Setting Range:
FST_LO
FST_HI
FDT_HI
FDT_PULSE
FDT_BAND
OL
STALL
LV
RUN
COMM
STEP_L
STEP_M
STEP_H

Multi-Function outputs OC1, OC2 and OC3 are open collector outputs and can be defined by the user. AUX1 and AUX2 are auxiliary relay outputs.

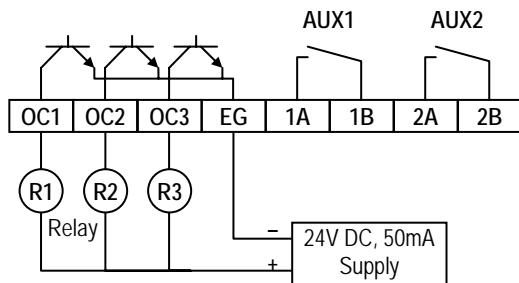

[Multi-Function Output Terminal Configuration]

FST_LO:

During acceleration, deceleration, and constant speed conditions, the inverter can generate an output signal via the multi-function output

terminals whenever its output frequency is below the value in [I/O 38].

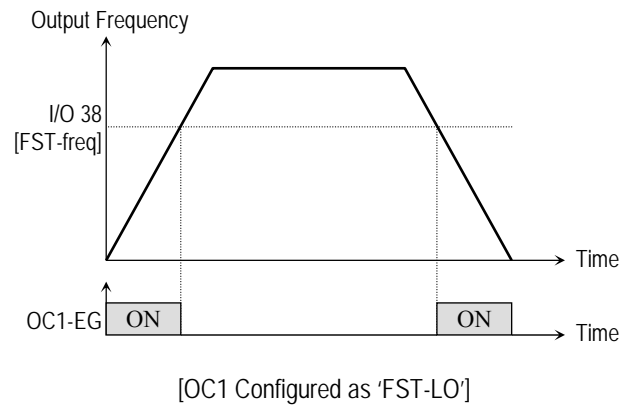

FST_HI:

The inverter can generate an output signal via the multi-function output terminals whenever its output frequency is above the value in [I/O 38].

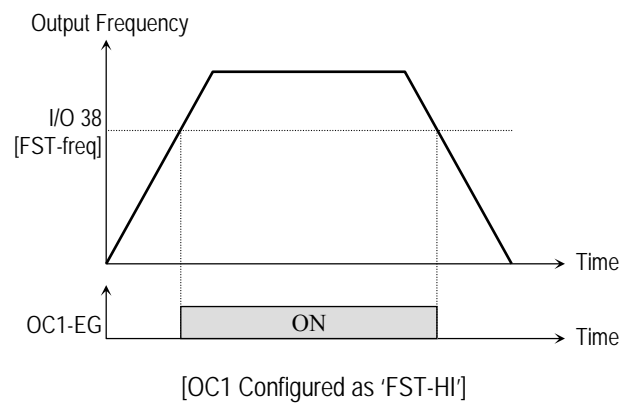

FDT_HI:

The inverter can generate an output signal via the multi-function output terminals whenever its output frequency is above the Frequency Detection Level set in [I/O 39]. The output is turned off when the output frequency goes below the Frequency Detection Level frequency minus the Frequency Detection Bandwidth [I/O 40].

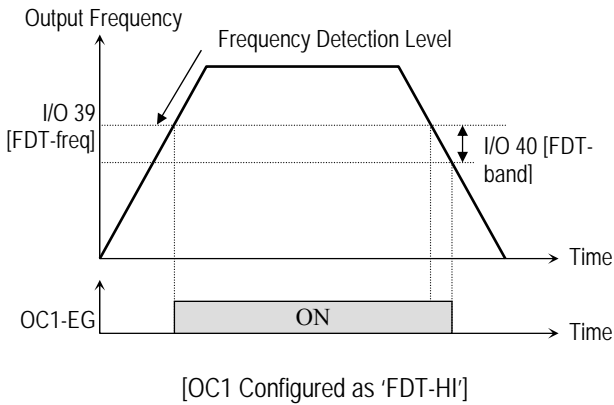

FDT_PULSE:

The inverter can generate a pulsed output signal for 100ms via the multi-function output terminals when its output frequency is above the Frequency Detection Level set in [I/O 39]. The output is pulsed again when the output frequency goes below the Frequency Detection Level frequency minus the Frequency Detection Bandwidth [I/O 40].

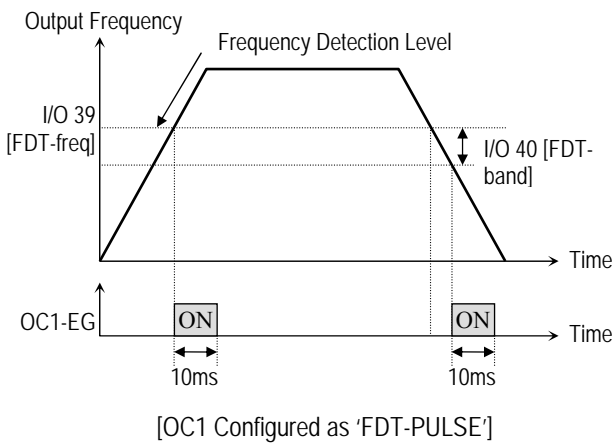

FDT_BAND:

The inverter can generate an output signal via the multifunction output terminals whenever its output frequency falls within its programmed bandwidth [I/O 40]. The output is turned off when the output frequency goes outside the Frequency Detection Bandwidth centered on the Frequency Detection Level frequency.

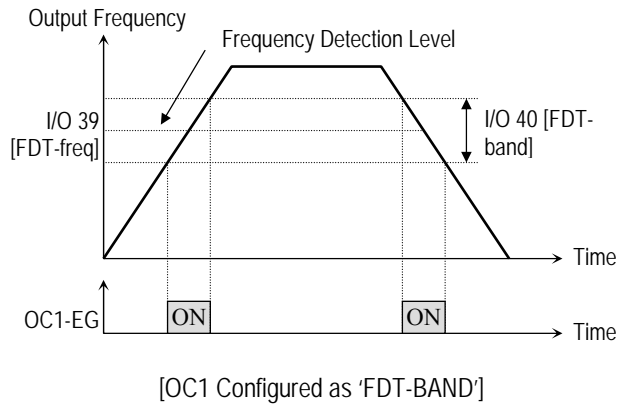

OL: [Overload Signal]

When the output current is above the overload warning level set in FUN 47 [OL level] for overload duration time set in FUN 48 [OL time], the inverter can generate an output signal via the multi-function output terminals. The output signal will turn off once the current output level falls below the value of [FUN 47] and hold for more than half of the time set in [FUN 48].

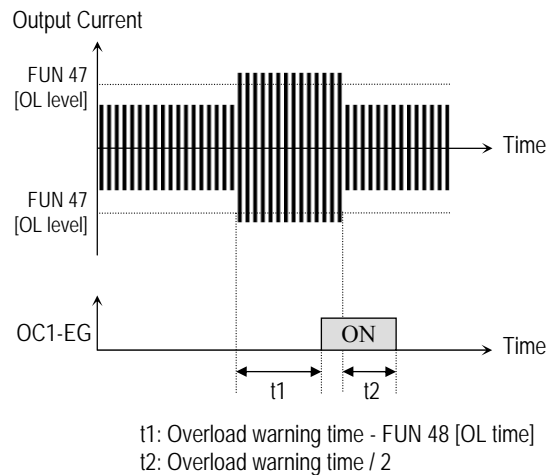

[OC1 Configured as 'OL']

STALL:

Whenever the inverter stalls, the inverter can generate an output signal via the multi-function output terminals. This is true throughout acceleration, deceleration and steady state conditions.

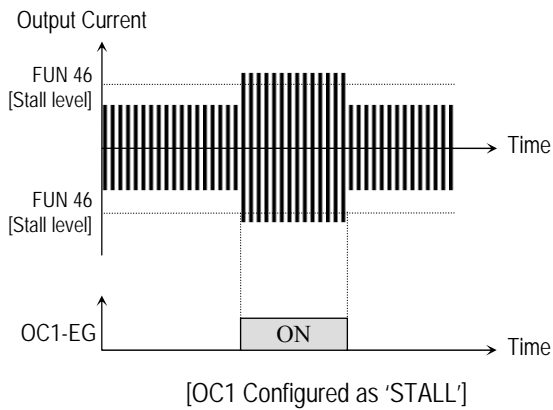

LV: [Low voltage]

Whenever the inverter's DC Link Voltage falls below the under voltage of the drive, the inverter can generate an output signal via the multi-function output terminals.

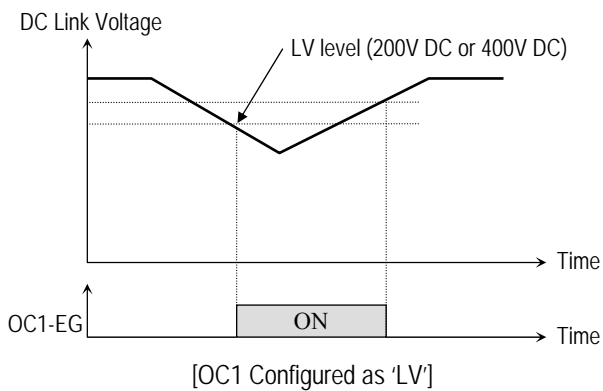

RUN: [On Running]

Whenever the inverter is in the Run Mode, the inverter can generate an output signal via the multi-function input terminals.

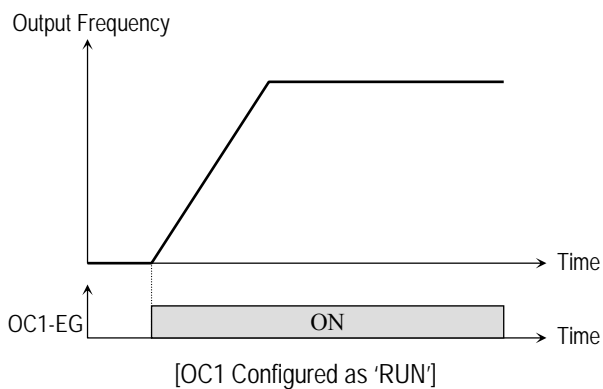

COMM:

Whenever the inverter is in a Bypass Mode, the inverter can generate an output signal via the multi-function output terminals.

STEP_L, STEP_M, STEP_H:

The inverter can generate an output signal via the multi-function output terminals for monitoring STEP commands. The output signal is in binary format as set by input terminals [I/O 01] through [I/O 06] via the OC1, OC2 and OC3 terminals.

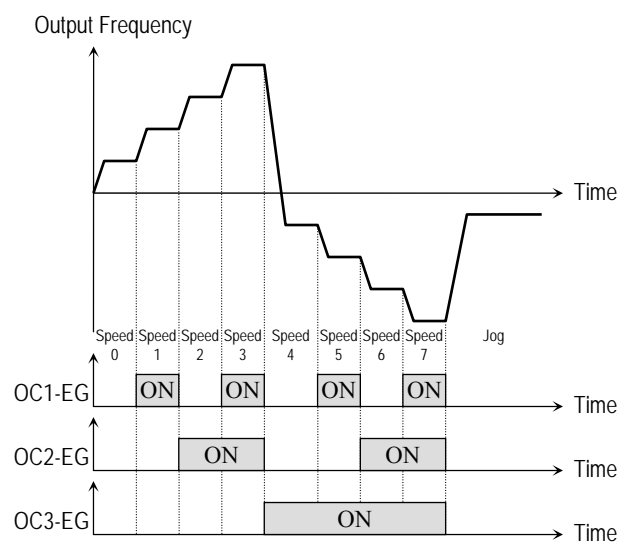

[OC1 Configured as 'STEP_L',
OC2 Configured as 'STEP_M',
OC3 Configured as 'STEP_H']

I/O 12: Jog Frequency

I/O ► Jog freq.
12 30.00 Hz

Setting Range: 0 to FUN 04
Factory Default: 30Hz

The Jog Frequency can be used to inch the drive Forward or Reverse.

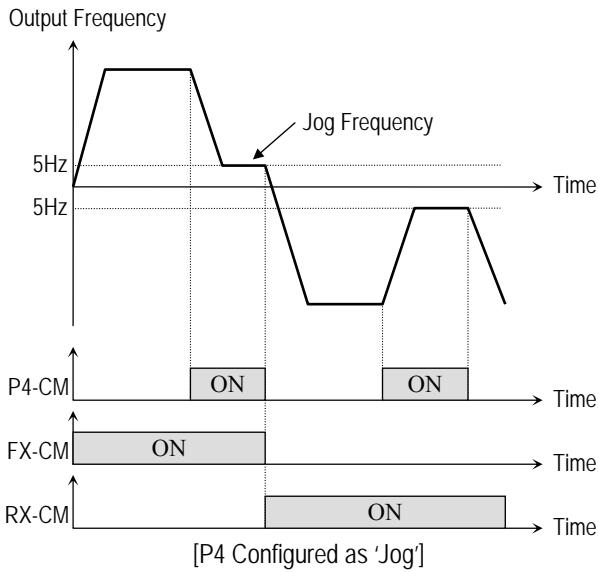

I/O 13 - 19: Multi-Step Frequency

I/O ► Step freq-1
13 10.00 Hz

■
■
■

I/O ► Step freq-7
19 37.00 Hz

Setting Range: 0 to 400Hz (FUN 04)

Up to 7 preset Step Frequencies may be selected in [I/O 13] through [I/O 19]. See multi-function input terminal selection for more detail.

I/O 20 - 33: Multi-Step Accel/Decel Time

I/O ► Acc time-1
20 1.0sec

I/O ► Dec time-1
21 1.0sec

■
■

I/O ► Acc time-7
32 7.0sec

I/O ► Dec time-7
33 7.0sec

Setting Range: 0 to 6000sec

Up to 7 preset Accel/Decel times may be selected in [I/O 20] through [I/O 33]. See multi-function input terminal selection for more detail.

I/O 34: Load Meter (LM) Selection

I/O 35: Load Meter (LM) Adjustment (15V Pulse)

I/O ► LM meter
34 Voltage

Setting Range: Voltage, Current
Factory Default: Voltage

I/O ► LM adj.
35 100 %

Setting Range: 0 to 120%
Factory Default: 100%

[I/O 34] selects either voltage or current to be displayed on the inverter's load meter. Output for the meter is a pulsed 0~10VDC. This output voltage may be adjusted in [I/O 35].

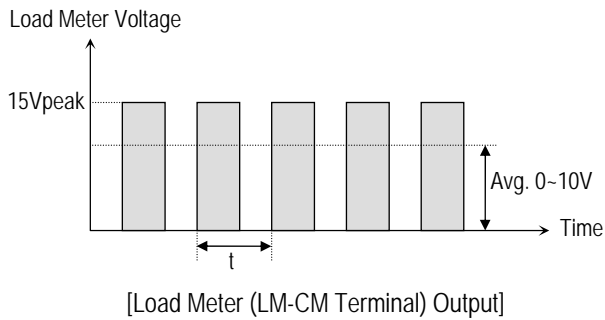

Load Meter Frequency (1/t) = 1.8kHz
 Duty (%) = (Output Voltage / Maximum Output Voltage) * 2/3
 Or = (Output Current / Rated Current * 1.5) * 2/3
 Load Meter Voltage = (Output Voltage / Maximum Output Voltage) * 10V
 Or = (Output Current / Rated Current * 1.5) * 10V

I/O 36: Frequency Meter (FM) Adjustment (15V Pulse)

I/O ► FM adj.
 36 100 %

Setting Range: 0 to 120%
 Factory Default: 100%

[I/O 36] adjust 0~10VDC pulsed frequency meter display signal on the FM terminal.

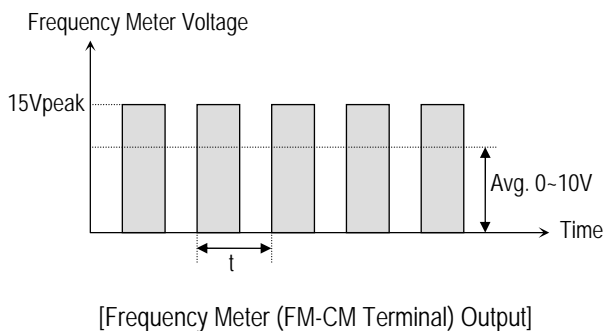

Frequency meter frequency (1/t) = (Output Frequency / Maximum Output Frequency) * 1.8kHz
 Duty (%) = (Output Voltage / Maximum Output Voltage) * 2/3
 Frequency Meter Voltage = (Output Voltage / Maximum Output Voltage) * 10V

I/O 37: IO Meter Adjustment (4~20mA)

I/O ► IO adj.
 37 100 %

Setting Range: 0 to 120%
 Factory Default: 100%

IO meter displays the inverter's output frequency as a current signal on the IO terminal. The current signal is 4~20mA. To adjust the current signal value, change [I/O 37] to the proper setting. The following equation may be used to determine the proper output.

IO Meter Current = 4mA + (Output Frequency / Maximum Frequency) * 16mA

**I/O 38: Frequency Steady Level
 I/O 39: Frequency Detection Level
 I/O 40: Frequency Detection Bandwidth**

I/O ► FST-freq.
 38 0.05 Hz

Setting Range: 0.5 to 400Hz (FUN 04)
 Factory Default: 0.05Hz

I/O ► FDT-freq.
 39 60.00 Hz

Setting Range: 0.5 to 400Hz (FUN 04)
 Factory Default: 60Hz

I/O ► FDT-freq.
 40 1.00 Hz

Setting Range: 0.5 to 30 Hz
 Factory Default: 1Hz

[I/O 38] through [I/O 40] are used in connection with multi-function output [I/O 07] through [I/O 11].

I/O 41: Speed Display Multiplier Factor
I/O 40: Speed Display Divider Factor

I/O ► Mul factor
 41 100

Setting Range: 0 to 999
 Factory Default: 100

I/O ► Div factor
 42 100

Setting Range: 1 to 999
 Factory Default: 100

[I/O 41] and [I/O 42] are used to translate [DRV 04] into line or process speed. Motor poles are defined in [FUN 54]. The following equation may be used to determine the proper output.

$$\text{Line Speed} = \frac{\text{Multiplier Factor}}{\text{Divide Factor}} \times \frac{120 * \text{Output Frequency}}{P \text{ (Number of Poles)}}$$

I/O 43: Input Terminal Status
I/O 44: Output Terminal Status

I/O ► Ter. input
 43 1000000001

I/O ► Ter. output
 44 10001

[I/O 43] and [I/O 44] displays the status of FX, RX, P1 – P6 input terminals and OC1, OC2, OC3, AUX1 (1A, 1B) and AUX2 (2A, 2B) output terminals.

Input Terminal Status

P6	P5	P4	P3	P2	P1	X	X	RX	FX
1	0	0	0	0	0	0	0	0	1

0: OFF, 1: ON

Output Terminal Status

AUX2	AUX1	OC3	OC2	OC1
1	0	0	0	1

0: OFF, 1: ON

I/O 45: Software Version

I/O ► S/W version
 45 2.04

[I/O 45] displays the software version of the inverter.

I/O 46: Fault History 1
I/O 47: Fault History 2

I/O ► Last fault 1
 46 OV Trip

I/O ► Last fault 2
 47 OC Trip

[I/O 46] and [I/O 47] review trip information. By using keypad, trip information (Over Current, Over Voltage and Frequency) may be displayed.

Example:

By using the PROG, UP and DOWN arrow key, old trip information (which contains current, frequency and trip) can be viewed.

I/O ► Last fault 1
 46 OV Trip

I/O ► Last fault 1
 46 35.60 Hz

I/O ► Last fault 1
 46 16.5 A

I/O ► Last fault 2
 47 OC Trip

I/O ► Last fault 2
 47 60.00 Hz

I/O ▶ Last fault 2
47 50.6 A

I/O 48: Option 1 Selection
I/O 49: Option 2 Selection

I/O ▶ Option 1
48 None

I/O ▶ Option 2
49 None

Setting Range: None
 RS485
 Modbus RTU
 F-Net
 Device Net

[I/O 48] and [I/O 49] allows the selection of available option cards for the inverter.

None:

This option indicates NO option cards are used in the inverter.

RS485:

This option card allows communication between the inverter and a computer using the inverter's software protocol. For more detailed information, see RS485 option manual.

Modbus RTU:

This option card allows communication between the inverter and a computer using Mochbus RTU protocol. For more detailed information, see Modbus RTU option manual.

Fnet:

This option card allows communication between the inverter and LS GLOFA PLC using exclusive protocol. For more detailed information, see Fnet option manual.

MMC:

This option card allows for multi-motors control with one inverter. For more detailed information,

see MMC option manual.

Device Net:

This option card allows communication between the inverter and a computer using Device Net protocol. For more detailed information, see Device Net option manual.

I/O 50: Inverter ID Number

I/O ▶ Inv. number
50 1

Setting Range: 1 to 31
Factory Default: 1

[I/O 50] defines the inverter's unique ID number. This function is used when the RS485/Modbus RTU option card is selected.

I/O 51: Baud Rate

I/O ▶ Baud-rate
51 9600 BPS

Setting Range: 1200, 2400, 4800, 9600, 19200
Factory Default: 9600

[I/O 51] selects the baud rate used in inverter communication. This function is used when the RS485/Modbus RTU/Fnet option card is selected.

I/O 52: Communication Timeout

I/O ▶ Comm. Timeout
52 10.0sec

Setting Range: 0 to 60sec
Factory Default: 10sec

[I/O 52] selects the time by which the inverter determines communication error between the inverter and option card. This function is used when the RS485/Modbus RTU/Fnet option card is selected.

I/O 53: PG Slip Frequency

I/O ▶ PG Slip Freq
53 5.00 Hz

Setting Range: 0 to 10Hz
Factory Default: 5Hz

[I/O 53] selects the slip frequency when using the 'PG' option card.

I/O 54: PG P-Gain

I/O ▶ PG. P-Gain
54 10

Setting Range: 0 to 255
Factory Default: 10

[I/O 54] establishes the proportional gain when using the 'PG' option card.

I/O 55: PG I-Gain

I/O ▶ PG. I-Gain
55 30

Setting Range: 0 to 255
Factory Default: 30

[I/O 55] establishes the integral gain when using the 'PG' option card.

I/O 56: PG Filter Gain

I/O ▶ PG. F-Gain
56 100

Setting Range: 0 to 255
Factory Default: 100

[I/O 56] establishes the filter gain when using the 'PG' option card.

I/O 57: Encoder Pulse Selection

I/O ▶ Enc pulse
57 512 Pulse

Setting Range: 100, 500, 512, 1000, 1024, 2000, 2048, 4000 pulse
Factory Default: 512 Pulse

[I/O 57] establishes the number of encoder pulses per revolution when using the 'PG' option card.

I/O 58: Digital Input Selection

I/O ▶ DI Mode
58 None

Setting Range: None, Freq. 1, Freq. 2
Factory Default: None

[I/O 58] selects the type of 12-bit digital input when using the 'DI_DA' option card.

I/O 59: Analog Output Selection

I/O ▶ DA Mode
59 Freq.

Setting Range: Freq., Voltage, Current
Factory Default: Freq.

[I/O 59] selects Frequency, Voltage of Current for the inverter output signal when using the 'DI_DA' option card.

I/O 60: Analog Output Adjustment

I/O ▶ DA adj.
60 100 %

Setting Range: 80 to 120%
Factory Default: 100%

[I/O 60] calibrates the 4~20mA output signal when using 'DI_DA' option card.

I/O 61: Inverter Number for Fnet

I/O ► FN: St. ID
61 1

Setting Range: 1 to 63
Factory Default: 1

[I/O 61] defines the inverter's unique ID number. This function is used when the Fnet option card is selected.

I/O 62: Inverter Number for Device Net

I/O ► DN: MAC ID
62 0

Setting Range: 0 to 63
Factory Default: 0

[I/O 62] defines the inverter's unique ID number. This function is used when the Device Net option card is selected.

I/O 63: Baud Rate for Device Net

I/O ► DN: BaudRate
63 125 kBPS

Setting Range: 125, 250, 500 kBPS
Factory Default: 125 kBPS

[I/O 63] selects the baud rate used in inverter communication. This function is used when the Device Net option card is selected.

I/O 64: Device Net Output Instance

I/O ► DN: Out Inst
64 Instance 20

Setting Range: 20, 21, 100, 101
Factory Default: 20

[I/O 64] selects the output instance used in inverter communication. This function is used when the Device Net option card is selected.

I/O 65: Device Net Input Instance

I/O ► DN: In Inst
65 Instance 70

Setting Range: 70, 71, 110, 111
Factory Default: 70

[I/O 65] selects the input instance used in inverter communication. This function is used when the Device Net option card is selected.

Blank Page

CHAPTER 6 - TROUBLESHOOTING & MAINTENANCE

6.1 Fault Display

When a fault occurs, the inverter turns off its output and displays the fault status in [DRV 05]. The last 2 faults are saved in [I/O 46] and [I/O 47] with the operation status at the instance of fault.

Keypad Display	Protective Function	Description
OC Trip	Over Current Protection	The inverter turns off its output when the output current of the inverter flows more than 200% of the inverter rated current.
GF Trip	Ground Fault Protection	The inverter turns off its output when a ground fault occurs and the ground fault current is more than the internal setting value of the inverter. Over current trip function may protect the inverter when a ground fault occurs due to a low ground fault resistance.
OV Trip	Over Voltage protection	The inverter turns off its output if the DC voltage of the main circuit increases higher than the rated value when the motor decelerates or when regenerative energy flows back to the inverter due to a regenerative load. This fault can also occur due to a surge voltage generated at the power supply system.
OC Limit	Current Limit Protection (Overload Protection)	The inverter turns off its output if the output current of the exceeds the value set in [FUN 49] over the time set in [FUN 50]
Fuse Open	Fuse Open	The inverter turns off its output by opening the fuse when something is wrong with the main circuit IGBT to protect the wiring from being damaged from short currents.
Over Heat	Heat Sink Over Heat	The inverter turns off its output if the heat sink over heats due to a damaged cooling fan or an alien substance in the cooling fan by detecting the temperature of the heat sink.
ETH	Electronic Thermal	The internal electronic thermal of the inverter determines the over heating of the motor. If the motor is overloaded the inverter turns off the output. The inverter cannot protect the motor when driving a multi-pole motor or when driving multiple motors, so consider thermal relays or other thermal protective devices for each motor. Overload capacity: Value set in [FUN 52]
EXT Trip	External Fault	Multi-function input configured as 'EXT_TRIP' has opened.
LV Trip	Low Voltage Protection	The inverter turns off its output if the DC voltage is below the detection level because insufficient torque or over heating of the motor can occurs when the input voltage of the inverter drops.
SC Trip	IGBT Short	The inverter turns off the output if an IGBT short through or an output short occurs.
BX	BX Protection (Instant Cut Off)	Used for the emergency stop of the inverter. The inverter instantly turns off the output when the BX terminal is turned ON, and returns to regular operation when the BX terminal is turned OFF. Take caution when using this function.
Inv. OLT	Inverter Overload	The inverter turns off its output when the output current of the inverter flows more than the rated level (150% for 1 minute, 200% for 0.5 seconds).
M/C Fail	Magnetic Contactor Fail	The inverter turns off its output if the magnetic contactor does not work or CVT fuse has opened.

To reset fault, Press **RESET** key, Close RST-CM terminals or connect input power.

If a problem persists, please contact the factory or your local distributor.

6.2 Fault Remedy

Protective Function	Cause	Remedy
Over Current Protection	<ol style="list-style-type: none"> 1) Acceleration/Deceleration time is too short compared to the GD^2 of the load 2) Load is larger than the inverter rating 3) Inverter turns output on when the motor is free running. 4) Output short or ground fault has occurred 5) Mechanical brake of the motor is operating too fast 6) Components of the main circuit have overheated due to a faulty cooling fan 	<ol style="list-style-type: none"> 1) Increase Accel/Decel time 2) Increase inverter capacity. 3) Operate after motor has stopped 4) Check output wiring 5) Check mechanical brake operation 6) Check cooling fan <p>(Caution) Operating inverter prior to correcting fault may damage the IGBT</p>
Ground Current Protection	<ol style="list-style-type: none"> 1) Ground fault has occurred at the output wiring of inverter. 2) The insulation of the motor is damaged due to heat. 	<ol style="list-style-type: none"> 1) Investigate the output wiring of inverter 2) Exchange motor
Over Voltage Protection	<ol style="list-style-type: none"> 1) Acceleration time is too short compared to the GD^2 of load 2) Regenerative load at the output 3) Line voltage high 	<ol style="list-style-type: none"> 1) Increase deceleration time 2) Use regenerative resistor option 3) Check line voltage
Current Limit Protection (Overload Protection)	<ol style="list-style-type: none"> 1) Load is larger than the inverter rating 2) Selected incorrect inverter capacity 3) Set incorrect V/F pattern 	<ol style="list-style-type: none"> 1) Increase capacity of motor and inverter 2) Select correct inverter capacity 3) Select correct V/F pattern
Fuse Damage	<ol style="list-style-type: none"> 1) Damage due to repeated over current protection 2) Damage due to instant deceleration when motor is at an excessive excitation status. 	<p>Exchange the fuse</p> <p>(Caution) The IGBT receives damages on many occasions when Fuse Open Trip occurs</p>
Heat Sink Overheat	<ol style="list-style-type: none"> 1) Cooling fan damaged or an alien substance inserted 2) Cooling system has faults 3) Ambient temperature high 	<ol style="list-style-type: none"> 1) Exchange cooling fans and/or eliminate alien substance 2) Check for alien substances in the heat sink 3) Keep ambient temperature under 45 °C
Electronic Thermal	<ol style="list-style-type: none"> 1) Motor has overheated 2) Load is larger than inverter rating 3) ETH level too low 4) Selected incorrect inverter capacity 5) Set incorrect V/F pattern 6) Operated too long at low speeds 	<ol style="list-style-type: none"> 1) Reduce load and/or running duty 2) Increase inverter capacity 3) Adjust ETH level to an appropriate level 4) Select correct inverter capacity 5) Select correct V/F pattern 6) Install a cooling fan with a separate power supply
External Fault	External fault has occurred	Eliminate fault at circuit connected to external fault terminal or cause of external fault input
Low Voltage Protection	<ol style="list-style-type: none"> 1) Line voltage low 2) Load larger than line capacity is connected to line (welding machine, motor with high starting current connected to the commercial line) 3) Faulty magnetic switch at the input side of the inverter 	<ol style="list-style-type: none"> 1) Check line voltage 2) Increase line capacity 3) Exchange magnetic switch
IGBT Short	<ol style="list-style-type: none"> 1) Short has occurred between the upper and lower IGBT. 2) Short has occurred at the output of the inverter 3) Acceleration/Deceleration time is too short compared to the GD^2 of load 	<ol style="list-style-type: none"> 1) Check IGBT 2) Check output wiring of inverter 3) Increase acceleration time
Inverter Overload	<ol style="list-style-type: none"> 1) Load is larger than inverter rating 2) Selected incorrect inverter capacity 	<ol style="list-style-type: none"> 1) Increase motor and/or inverter capacity 2) Select correct inverter capacity
Magnetic Contactor Fail	<ol style="list-style-type: none"> 1) The magnetic contactor does not work. 2) The CVT fuse has opened. 	<ol style="list-style-type: none"> 1) Replace the magnetic contactor 2) Replace the CVT fuse

6.3 Troubleshooting

Condition	Check Point
The Motor Does Not Rotate	<ol style="list-style-type: none"> 1) Main circuit inspection: <ul style="list-style-type: none"> ☞ Is the input (line) voltage normal? (Is the LED in the inverter lit?) ☞ Is the motor connected correctly? 2) Input signal inspection: <ul style="list-style-type: none"> ☞ Check the operating signal input to the inverter. ☞ Check the forward and the reverse signal input simultaneously to the inverter? ☞ Check the command frequency signal input to the inverter. 3) Parameter setting inspection: <ul style="list-style-type: none"> ☞ Is the reverse prevention (FUN 03) function set? ☞ Is the operation mode (FU1N 02) set correctly? ☞ Is the command frequency set to 0? 4) Load inspection: <ul style="list-style-type: none"> ☞ Is the load too large or is the motor jammed? (Mechanical brake) 5) Other: <ul style="list-style-type: none"> ☞ Is the alarm displayed on the keypad or is the alarm LED lit? (STOP LED blinks)
The Motor Rotates in Opposite Directions	<ul style="list-style-type: none"> ☞ Is the phase sequence of the output terminal U, V, W correct? ☞ Is the starting signal (forward/reverse) connected correctly?
The Difference Between the Rotating Speed and the Reference is Too Large	<ul style="list-style-type: none"> ☞ Is the frequency reference signal correct? (Check the level of the input signal) ☞ Is the following parameter setting is correct? Lower Limit Frequency (FUN 27), Upper Limit Frequency (FUN 26), Analog Frequency Gain (FUN 20-23) ☞ Is the input signal line influenced by external noise? (Use a shielded wire)
The Inverter Does Not Accelerate or Decelerate Smoothly	<ul style="list-style-type: none"> ☞ Is the acceleration/deceleration time is set too short a period of time? ☞ Is the load too large? ☞ Is the Torque Boost (FUN 09-10) value is too high that the current limit function and the stall prevention function do not operate?
The Motor Current is Too High	<ul style="list-style-type: none"> ☞ Is the load too large? ☞ Is the Torque Boost Value (manual) too high?
The Rotating Speed Does Not Increase	<ul style="list-style-type: none"> ☞ Is the Upper Limit Frequency (FUN 26) value correct? ☞ Is the load too large? ☞ Is the Torque Boost (FUN 09-10) value too high that the stall prevention function (FUN 45-46) does not operate?
The Rotating Speed Oscillates When the Inverter is Operating.	<ol style="list-style-type: none"> 1) Load inspection: <ul style="list-style-type: none"> ☞ Is the load oscillating? 2) Input signal inspection: <ul style="list-style-type: none"> ☞ Is the frequency reference signal oscillating? 3) Other: <ul style="list-style-type: none"> ☞ Is the wiring too long when the inverter is using V/F control? (Over 500m)

 **CAUTION**

Risk of Electric Shock – More than one disconnect switch may be required to de-energize the equipment before servicing.

6.3.1 Motor Does Not RUN

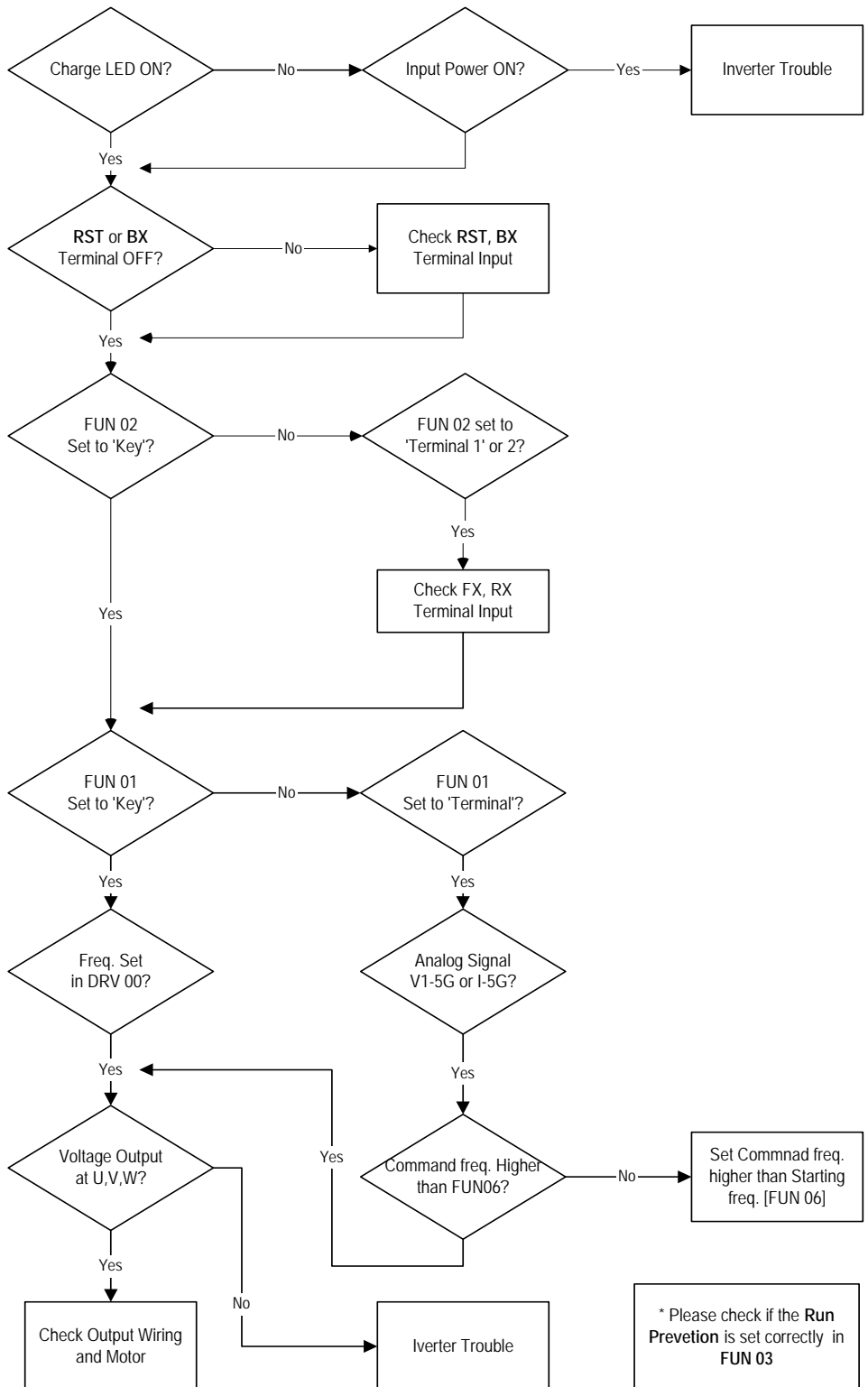

6.3.2 Motor Speed NOT EQUAL to the Command Frequency

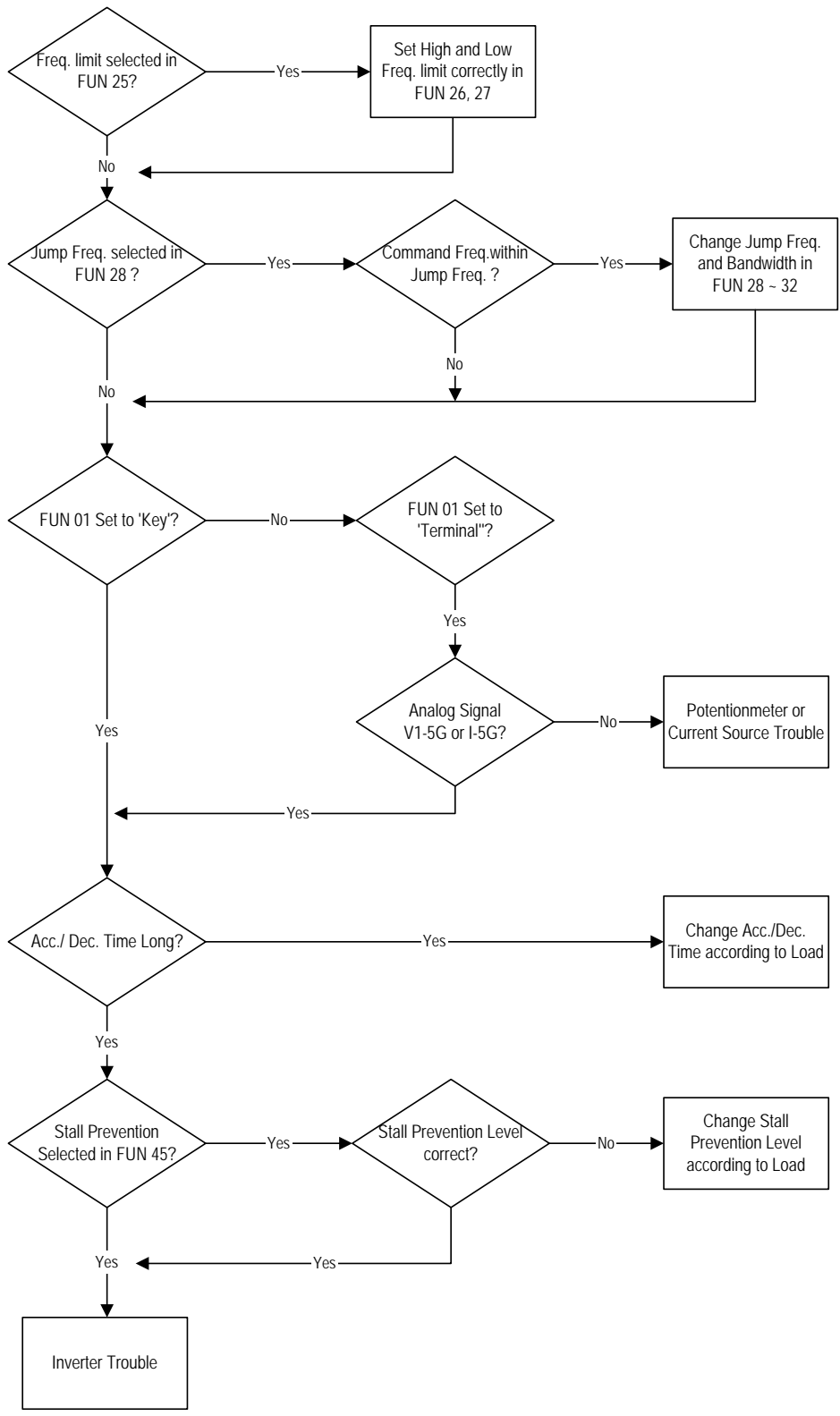

6.3.3 Motor Does Not Run Smoothly

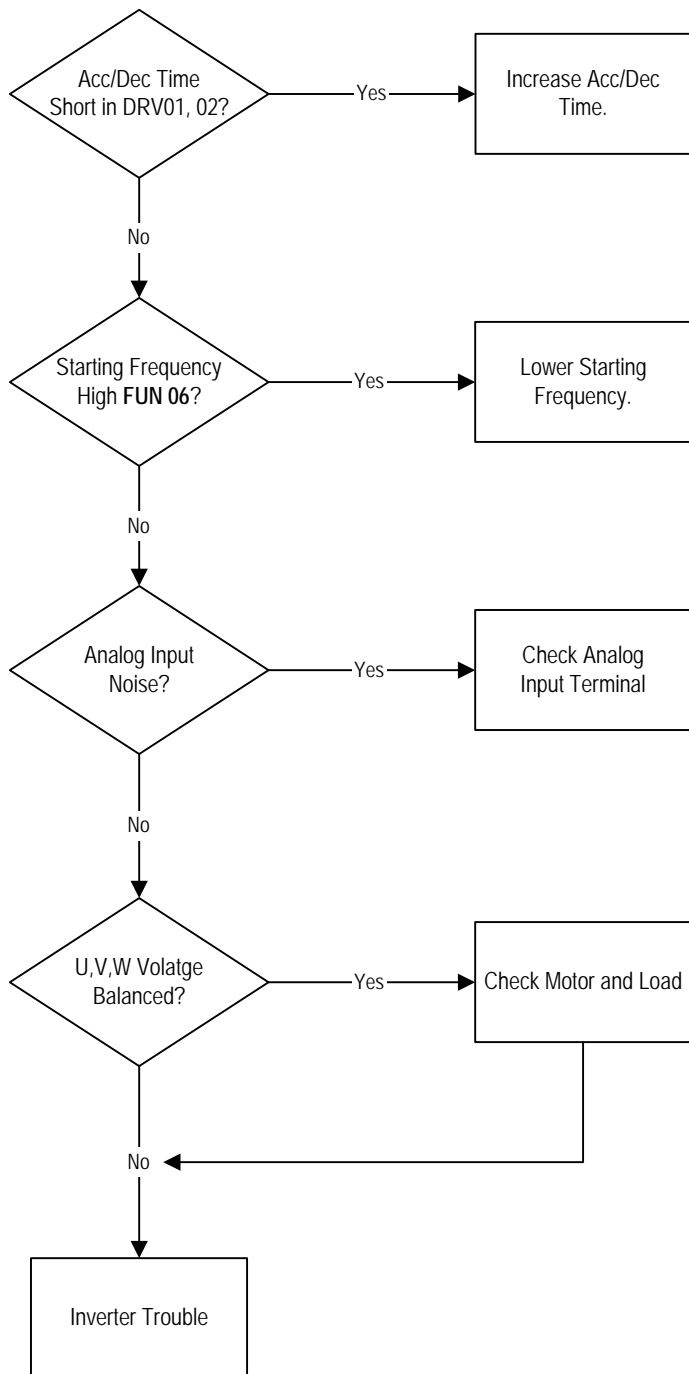

6.3.4 Motor Overheats

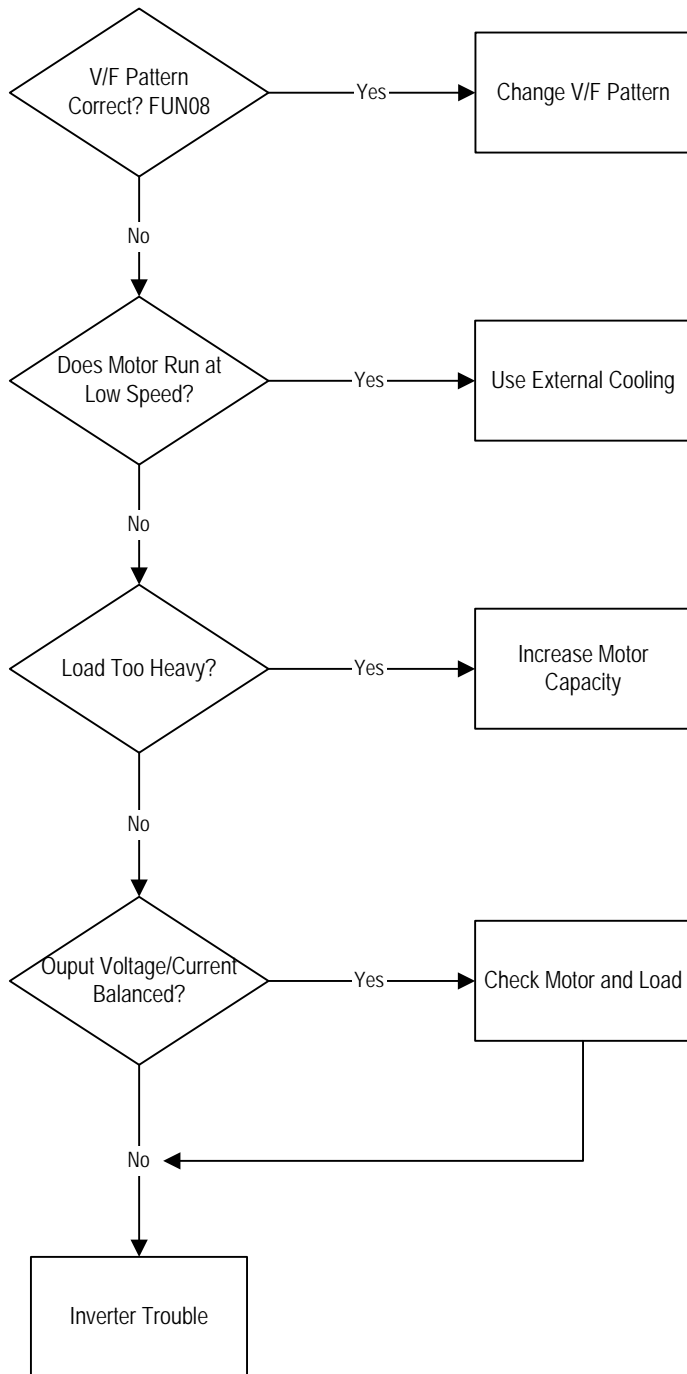

6.4 How to Check Power Components

Before checking the power components, be sure to disconnect AC Input supply and wait until the Main Electrolytic Capacitors (DCP-DCN) discharge.

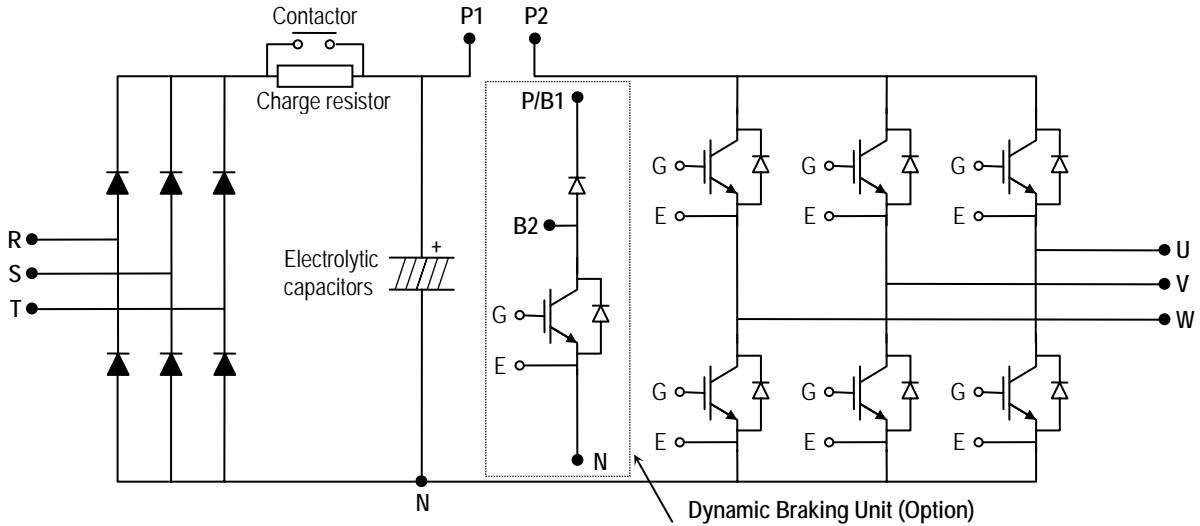

■ Diode Module Check

Check Point	Resistance
R, S, T – P1	50 k ohms or more
R, S, T – N	50 k ohms or more

■ Charge Resistor Check

Check Point	Resistance
Contactor terminals	Resistance depending on models

■ DB(Dynamic Braking) IGBT (Option)

Check Point	Resistance
B2 - N	50 k ohms or more
G - N	A few kilo ohms

■ IGBT Module Check

Check Point	Resistance
B2 - N	50 k ohms or more
G - N	A few kilo ohms

6.5 Maintenance

The iH series is an industrial electronic product with advanced semiconductor elements. However, temperature, humidity, vibration and aging parts may still affect it. To avoid this, it is recommended to perform routine inspections.

6.5.1 Precautions

- Be sure to remove the drive power input while performing maintenance.
- Be sure to perform maintenance only after checking that the bus has discharged. The bus capacitors in the electronic circuit can still be charged even after the power is turned off.
- The correct output voltage can only be measured by using a rectifier voltage meter. Other voltage meters, including digital voltage meters, are likely to display incorrect values caused by the high frequency PWM output voltage of the drive.

6.5.2 Routine Inspection

Be sure to check the following before operation:

- The conditions of the installation location
- The conditions of the drive cooling
- Abnormal vibration
- Abnormal heating

6.5.3 Periodical Inspection

- Are there any loose bolt, nut or rust caused by surrounding conditions? If so, tighten them up or replace them.
- Are there any deposits inside the drive-cooling fan? If so, remove using air.
- Are there any deposits on the drive's PCB (Printed Circuit Boards)? If so, remove using air.
- Are there any abnormalities in the various connectors of the drive's PCB? If so, check the condition of the connector in question.
- Check the rotating condition of the cooling fan, the size and condition of the capacitors and the connections with the magnetic contactor. Replace them if there are any abnormalities.

6.5.4 Internal Fuse Replacement

When the internal fuse is opened the IGBT's should be checked thoroughly before replacing the fuse. Contact the factory for replacement fuse information.

6.6 Daily and Periodic Inspection Items

Inspection Location	Inspection Item	Inspection	Period			Inspection Method	Criterion	Measuring Instrument
			Daily	1 year	2 year			
All	Ambient Environment	Is there any dust? Is the ambient temperature and humidity adequate?	O			Refer to the precautions	Temperature: -10~+45 no freezing. Humidity: Under 50% no dew	Thermometer, Hygrometer, Recorder
	Equipment	Is there any abnormal oscillation or noise	O			Use sight and hearing	No abnormality	
	Input Voltage	Is the input voltage of the main circuit normal	O			Measure the voltage between the terminals R, S, T		Digital Multi-Meter/Tester
Main Circuit	All	Megger check (between the main circuit and the ground) Are any fixed parts removed? Are there any traces of overheating at each component's cleaning?		O	O	Undo the inverter connections short the terminals R, S, T, U, V, W and measure between these parts and the ground. Tighten the screws. Visual check.	Over 5MΩ No fault	DC 500V class Megger
	Conductor/Wire	Is the conductor rusty? Is the wire coating damaged?		O		Visual check	No fault	
	Terminal	Is there any damage?		O		Visual check	No fault	
	IGBT Module /Diode Module	Check the resistance between each of the terminals.			O	Undo the inverter connection and measure the resistance between R, S, T ⇔ P, N and U, V, W ⇔ P, N with a tester.	(Refer 'How to Check Power Components')	Digital Multi-Meter/Analog Tester
	Smoothing Capacitor	Is there any liquid coming out? Is the safety pin out, and is there any swelling? Measure the capacitance.	O	O		Visual check. Measure with a capacitance-measuring device.	No fault Over 85% of the rated capacity	Capacitance Measuring Device
	Relay	Is there any chattering noise during operation? Is there any damage to the contact		O		Auditory check. Visual check.	No fault	
	Resistor	Is there any damage to the resistor insulation? Is the wiring in the resistor damaged (open)?		O		Visual check. Disconnect one of the connections and measure with a tester.	No fault Error must be within ± 10% the displayed resistance	Digital Multi-Meter/Analog Tester
Control Circuit Protective Circuit	Operation Check	Is there any unbalance between each phases of the output voltage? Nothing must be wrong with display circuit after executing the sequence protective operation		O		Measure the voltage between the output terminals U, V and W. Short and open the inverter protective circuit output.	The voltage balance between the phases for 200V (800V) class is under 4V (8V). The fault circuit operates according to the sequence.	Digital Multi-Meter/Rectifying Voltmeter
Cooling System	Cooling Fan	Is there any abnormal oscillation or noise? Is the connection area loose?	O	O		Turn OFF the power and turn the fan by hand. Tighten the connections.	Must rotate smoothly. No fault	
Display	Meter	Is the displayed value correct?	O	O		Check the meter reading at the exterior of the panel	Check the specified and management values.	Voltmeter/ Ammeter etc.
Motor	All	Are there any abnormal vibrations or noise? Is there any unusual odor?	O			Auditory, sensory, visual check. Check for overheat and damage.	No fault	
	Insulation Resistor	Megger check (between the output terminals and the ground terminal)			O	Undo the U, V and W connections and tie the motor wiring.	Over 5MΩ	500V class Megger

Note: Values in () is for the 400V class inverters.

APPENDIX A - FUNCTIONS BASED ON USE

Set the function properly according to the load and operating conditions. Application and related functions are listed in the following table.

Use	Related Parameter Code
Accel/Decel Time, Pattern Adjustment	DRV-01 [Acceleration Time], DRV-02 [Deceleration Time], FUN 11 [Acceleration Pattern], FUN 12 [Deceleration Pattern]
Reverse Rotation Prevention	FUN 03 [Forward, Reverse Prevention]
Minimum Accel/Decel Time	FUN 11 [Acceleration Pattern], FUN 12 [Deceleration Pattern]
Accel/Decel at Continuous Rating Range	FUN 11 [Acceleration Pattern], FUN 12 [Deceleration Pattern]
Braking Operation Adjustment	FUN 15 [Stop Method], FUN 33~36 [DC Braking],
Operations for Frequencies Over 60 Hz	FUN 04 [Maximum Frequency], FUN 25~26 [Frequency Limit]
Selecting an Appropriate Output Characteristics for the Load	FUN 03 [Maximum Frequency], FUN 05 [Base Frequency]
Motor Output Torque Adjustment	FUN 05 [Starting Frequency], FUN 09~10 [Torque Boost], FUN 45~46 [Stall Prevention], FUN 39~40 [Rated Motor]
Output Frequency Limit	FUN 25~27 [Frequency Upper/Lower Limit], I/O 20~24 [Analog Frequency Setting]
Motor Overheat Protection	FUN 51~53 [Electronic Thermal], FUN 38~40 [Rated Motor]
Multi Step Operation	I/O 01~06 [Define the Multi Function Input Terminals], I/O 12~19 [Jog, Multi Step Frequency], FUN 25~27 [Frequency Upper/Lower Limit]
Jog Operation	I/O 12 [Jog Frequency]
Frequency Jump Operation	FUN 28~32 [Frequency Jump]
Timing the Electronic Brake Operation	I/O 39~40 [Frequency Detection Level], I/O 07~11 [Multi Function Output]
Displaying the Rotating Speed	DRV 04 [Motor Speed], FUN 41~42 [Motor RPM Display Gain]
Function Alteration Prevention	FUN 98 [Parameter Lock]
Energy Saving	FUN 14 [Energy Saving]
Auto Restart Operation After Alarm Stop	FUN 42~43 [Auto Retry]
PID Feedback Operation	FUN 62~72 [PID Operation]
Frequency Reference Signal and Output Adjusting	FUN 20~24 [Analog Frequency Setting]
Define the Multi-Function Input Terminals	I/O 01~06 [Define the Multi-Function Input Terminals]
Define the Multi-Function Input Terminals	I/O 07~11 [Multi Function Auxiliary Contact Output Setting]
Commercial Line ⇔ inverter Switchover Operation	I/O 01~06 [Define the Multi-Function Input Terminals], I/O 07~11 [Multi-Function Auxiliary Contact Output Setting]
Frequency Meter Calibration	I/O 34~37 [FM Output]
Operate by Communicating with a Computer	I/O 50 [Inverter No.], I/O 51 [communication Speed], I/O 52 [communication Timeout]

APPENDIX B - PARAMETERS BASED ON APPLICATION

Application	Parameter Code
DRV Group	
When you want to change the frequency setting	DRV 00
When you want to change the acceleration and deceleration time of the motor	DRV 01, DRV 02
FUN Group	
When you want to use the Jump Code	FUN 00
When you want to change the run/stop method	FUN 02
When you want to change the frequency reference source	FUN 01
When you want to prevent the motor from rotating at opposite directions	FUN 03
When you want to change the stopping method	FUN15
When DC injection braking is required before starting	FUN 33-36
When you want to set the maximum frequency and the base frequency according to the rated torque of the motor	FUN 37-40
When you want to adjust the starting frequency	FUN 06
When a large starting torque is needed for loads such as elevators (Manual/Auto Torque Boost)	FUN 09-10
When you want to select an appropriate output characteristic (V/F characteristic) according to loads	FUN 08
When you want to set up your own V/F pattern	FUN 16-19
When you want to use the energy saving function	FUN 14
When you want to protect the motor from overheating	FUN 51-54
When you want to output a signal when the overload condition lasts more than a fixed amount of time	FUN 47-48
When you want to cut off the output when the overload condition lasts more than a fixed amount of time	FUN 49-50
When you want to set the stall prevention function	FUN 45-46
When you want to prevent the resonance from the oscillating characteristics of a machine	FUN 28-31
When you want to start the inverter as soon as the power is turned ON	FUN 55
When you want to restart the inverter by resetting the fault when a fault occur	FUN 42-43
When you want to use the instant power failure restart function (Speed Search)	FUN 56-58
When you want to enter the motor constants	FUN 38-40
When you want to reduce noise or leakage current by changing the PWM carrier frequency	FUN 61
When you want to operate using PID feedback	FUN 62-72
When you want to copy the inverter parameter to another inverter	FUN 95-96
When you want to initialize the parameters	FUN 97
When you want to prevent the parameters from being changed	FUN 98
I/O Group	
When you want to set the analog voltage or current for the frequency reference	I/O 34-37
When you want to set the step frequency	I/O 13-19
When you want to change the functions for the input terminals P1-P6	I/O 12 ~ 14
When you want to check the status of the input/output terminals	I/O 43-44
When you want to check the fault history of the inverter	I/O 46-47
When you want to use the JOG and multi step speed operation	I/O 01-06
When you want to change the 1 st ~ 7 th acceleration/deceleration time	I/O 20-23
When you want to set the frequency detection level	I/O 39-40
When you want to change the functions of the multi function auxiliary contact output (AXA-AXC)	I/O 07-11
When you want to exchange the motor to commercial power line from inverter or the opposite	I/O 01-06

DECLARATION OF CONFORMITY

Council Directive(s) to which conformity is declared:

CD 73/23/EEC and CD 89/336/EEC

Units are certified for compliance with:

**EN50178 (1997)
EN 50081-1 (1992) for 460V series inverters
EN 50081-2 (1993) for 230V series inverters
EN 55011 (1994)
EN 50082-2 (1995)
EN 61000-4-2 (1995)
ENV 50140 (1993) & ENV 50204 (1995)
EN 61000-4-4 (1995)
EN 61000-4-5 (1995) for 460V series inverters
ENV 50141 (1993)
EN 61000-4-8 (1993)**

Type of Equipment:

Inverter (Power Conversion Equipment)

Model Name:

SV - iH Series

Trade Mark:

LS Industrial Systems Co., Ltd.

Representative:

LG International (Deutschland) GmbH

Address:

**Lyoner Strasse 15,
60528, Frankfurt am Main,
Germany**

Manufacturer:

LS Industrial Systems Co., Ltd.

Address:

**181, Samsung-ri, Mokchon-eup,
Chonan, Chungnam, 330-845
Korea**

We, the undersigned, hereby declare that equipment specified above conforms to the Directives and Standards mentioned.

Place:

**Frankfurt am Main
Germany**

**Chonan, Chungnam,
Korea**

 20/02/01
(Signature / Date)

Mr. Ik-Seong Yang / Dept. Manager
(Full name / Position)

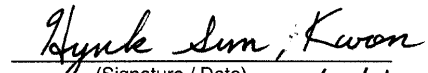
 02/04/01
(Signature / Date)

Mr. Hyuk-Sun Kwon / General Manager
(Full name / Position)

TECHNICAL STANDARDS APPLIED

The standards applied in order to comply with the essential requirements of the Directives 73/23/CEE "Electrical material intended to be used with certain limits of voltage" and 89/336/CEE "Electromagnetic Compatibility" are the following ones:

• EN 50178 (1997)	“Safety of information technology equipment”.
• EN 50081-1 (1992)	“Electromagnetic compatibility. Generic emission standard. Part 1: Residential, commercial and light industry.”
• EN 50081-2 (1993)	“Electromagnetic compatibility. Generic emission standard. Part 2: Industrial environment.”
• EN 55011 (1994)	“Limits and methods of measurements of radio disturbance characteristics of industrial, scientific and medical (ISM) radio frequency equipment.”
• EN 50082-2 (1995)	“Electromagnetic compatibility. Generic immunity standard. Part 2: Industrial environment.”
• EN 61000-4-2 (1995)	“Electromagnetic compatibility (EMC). Part 4: Testing and measurement techniques. Section 2: Electrostatic discharge immunity test. Basic EMC Publication (IEC 1000-4-2: 1995).”
• ENV 50140 (1993)	“Electromagnetic compatibility - Basic immunity standard - Radiated radio- frequency electro magnetic field - Immunity test.”
• ENV 50204 (1995)	“Radio electromagnetic field from digital radio telephones.”
• EN 61000-4-4 (1995)	“Electromagnetic compatibility (EMC). Part 4: Testing and measurement techniques. Section 4: Electrical fast transients / burst immunity test. Basic EMC Publication (IEC 1000-4-4: 1995).”
• EN 61000-4-5: 1995	“Electromagnetic compatibility (EMC). Part 4: Testing and measurement techniques. Section 5: Surge immunity test. Basic EMC Publication (IEC 1000-4-5: 1995).”
• ENV 50141 (1993)	“Electromagnetic compatibility. Basic immunity standard. Conducted disturbances induced by radio-frequency fields.”
• EN 61000-4-8 (1993)	“Electromagnetic compatibility (EMC). Part 4: Testing and measurement techniques. Section 8: Power frequency magnetic field immunity test - Basic EMC Publication (IEC 1000-4-8: 1993).”

RFI FILTERS

THE L.G. RANGE OF POWER LINE FILTERS **FF (Footprint) – FE (Standard)** SERIES, HAVE BEEN SPECIFICALLY DESIGNED WITH HIGH FREQUENCY **LS INVERTERS**, THE USE L.G. FILTERS, WITH THE INSTALLATION ADVICE OVERLEAF HELP TO ENSURE TROUBLE FREE USE ALONG SIDE SENSITIVE DEVICES AND COMPLIANCE TO CONDUCTED EMISSION AND IMMUNITY STANDARDS TO EN50081

CAUTION

IN CASE OF A LEAKAGE CURRENT PROTECTIVE DEVICES IS USED ON POWER SUPPLY, IT MAY BE FAULT AT POWER-ON OR OFF.

IN AVOID THIS CASE, THE SENSE CURRENT OF PROTECTIVE DEVICE SHOULD BE LARGER THAN VALUE OF LAKAGE CURRENT AT WORST CASE IN THE BELOW TABLE.

RECOMMENDED INSTALLATION INSTRUCTIONS

To conform to the **EMC** directive, it is necessary that these instructions be followed as closely as possible. Follow the usual safety procedures when working with electrical equipment. All electrical connections to the filter, inverter and motor must be made by a qualified electrical technician.

- 1-) Check the filter rating label to ensure that the current, voltage rating and part number are correct.
- 2-) For best results the filter should be fitted as closely as possible to the incoming mains supply of the wiring enclosure, usually directly after the enclosures circuit breaker or supply switch.
- 3-) The back panel of the wiring cabinet of board should be prepared for the mounting dimensions of the filter. Care should be taken to remove any paint etc. from the mounting holes and face area of the panel to ensure the best possible earthing of the filter.
- 4-) Mount the filter securely.
- 5-) Connect the mains supply to the filter terminals marked **LINE**, connect any earth cables to the earth stud provided. Connect the filter terminals marked **LOAD** to the mains input of the inverter using short lengths of appropriate gauge cable.
- 6-) Connect the motor and fit the ferrite core (output chokes) as close to the inverter as possible. Armoured or screened cable should be used with the 3 phase conductors only threaded twice through the center of the ferrite core. The earth conductor should be securely earthed at both inverter and motor ends. The screen should be connected to the enclosure body via and earthed cable gland.
- 7-) Connect any control cables as instructed in the inverter instructions manual.

IT IS IMPORTANT THAT ALL LEAD LENGTHS ARE KEPT AS SHORT AS POSSIBLE AND THAT INCOMING MAINS AND OUTGOING MOTOR CABLES ARE KEPT WELL SEPARATED.

FF SERIES (Footprint)

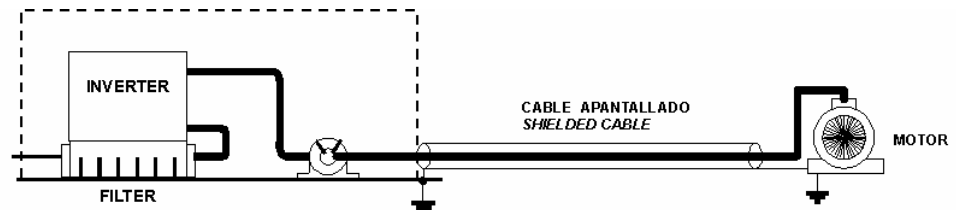

FE SERIES (Standard)

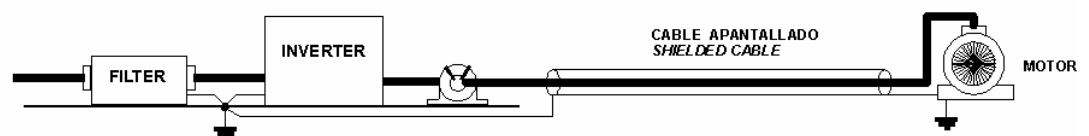

RFI Filters (Footprint - Standard) for iH SERIES

iH series / Filtros Estándar / Standard Filters														
VARIADOR INVERTER	POT. POWER	CODIGO CODE	INTENS. CURRENT	TENSION VOLTAGE	CORRIENTE DE FUGAS LEAKAGE CURRENT		DIMENSIONES DIMENSIONS			MONTAJE MOUNTING		PESO WEIGHT	TORNILLOS DE FIJACION MOUNT	CHOQUES DE SALIDA OUTPUT CHOKES
TRIFASICOS THREE PHASE				NOM. MAX.		L	W	H	Y	X				
SV030iH-2U	30kW	FE-T150-2	150A	250VAC	1.3A	150A	480	200	160		468	166	---	FS - 3
SV037iH-2U	37kW	FE-T170-2	170A	250VAC	1.3A	150A	480	200	160		468	166	---	FS - 3
SV045iH-2U	45kW	FE-T230-2	230A	250VAC	1.3A	150A	580	250	205		560	170	---	FS - 4
SV055iH-2U	55kW	FE-T280-2	280A	250VAC	1.3A	150A	580	250	205		560	170	---	FS - 4
SV030iH-4U	30kW	FE-T070-2	70A	380VAC	1.3A	150A	350	180	90		338	146	---	FS - 3
SV037iH-4U	37kW	FE-T100-2	100A	380VAC	1.3A	150A	425	200	130		408	166	---	FS - 3
SV045iH-4U	45kW	FE-T120-2	120A	380VAC	1.3A	150A	425	200	130		408	166	---	FS - 3
SV055iH-4U	55kW													
SV075iH-4U	75kW	FE-T170-2	170A	380VAC	1.3A	150A	480	200	160		468	166	---	FS - 3
SV090iH-4U	90kW	FE-T230-2	230A	380VAC	1.3A	150A	580	250	205		560	170	---	FS - 4
SV110iH-4U	110kW	FE-T280-2	280A	380VAC	1.3A	150A	580	250	205		560	170	---	FS - 4
SV132iH-4U	132kW													
SV160iH-4U	160kW	FE-T400-2	400A	380VAC	1.3A	150A	700	370	250		640	300	---	FS - 4
SV220iH-4U	220kW	FE-T480-2	480A	380VAC	1.3A	150A	700	370	250		640	300	---	FS - 4

DIMENSIONS

FF SERIES (Footprint)

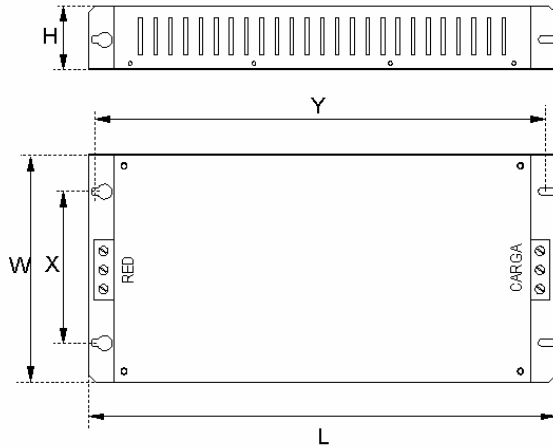

FE SERIES (Standard)

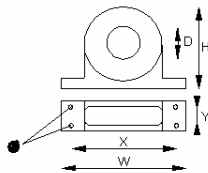
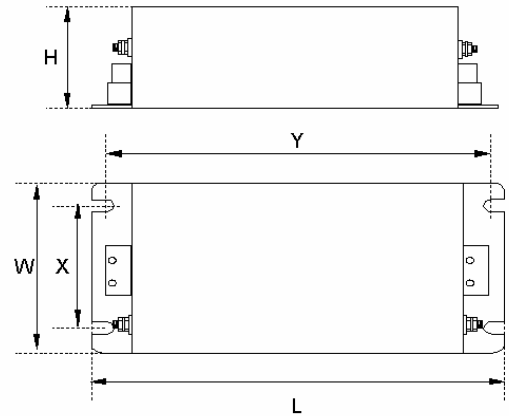

FS SERIES (output chokes)

TIPO	D	W	H	X	O
FS - 1	21	85	46	70	5
FS - 2	28,5	105	62	90	5
FS - 3	48	150	110	125 x 30	5
FS - 4	58	200	170	180 x 45	5

Polígono Industrial de Palou
 08400 Granollers (Barcelona)
 SPAIN / ESPAÑA
 Tel: +34 93 861 14 60
 Fax: +34 93 879 26 64
 E-mail: info@lifasa.com
vsd@lifasa.es
<http://www.lifasa.com>



INTERNATIONAL CAPACITORS

UL MARKING

1. Short Circuit Rating

“Suitable For Use On A Circuit Capable Of Delivering Not More Than Table1_RMS Symmetrical Amperes, 240V for rated 240V drives, 480V for rated 480V drives Volts Maximum,” or equivalent.

Table 1. RMS Symmetrical Amperes for iH series.

Model	Rating
SV030iH-4U, SV037iH-4U	5,000A
SV045iH-4U, SV055iH-4U, SV075iH-4U, SV090iH-4U, SV110iH-4U, SV132iH-4U	10,000A
SV160iH-4U, SV220iH-4U	18,000A

2. SHORT CIRCUIT FUSE/BREAKER MARKING

Use Class H or K5 UL Listed Input Fuse and UL Listed Breaker Only. See the table below for the Voltage and Current rating of the fuses and the breakers.

Input Voltage	Motor [kW]	Inverter	External Fuse		Breaker		Internal Fuse			
			Current [A]	Voltage [V]	Current [A]	Voltage [V]	Current [A]	Voltage [V]	Manufacturer	Model Number
400V CLASS	30	SV030iH-4U	100	500	100	460	125	600	Hinode Elec.	600FH-125S
	37	SV037iH-4U	100	500	225	460	150	600	Hinode Elec.	600FH-150S
	45	SV045iH-4U	100	500	225	460	200	600	Hinode Elec.	600FH-200S
	55	SV055iH-4U	150	500	225	460	200	600	Hinode Elec.	600FH-200S
	75	SV075iH-4U	200	500	225	460	125	600	Hinode Elec.	600FH-125S
	90	SV090iH-4U	250	500	400	460	200	600	Hinode Elec.	600FH-200S
	110	SV110iH-4U	300	500	400	460	200	600	Hinode Elec.	600FH-200S
	132	SV132iH-4U	400	500	400	460	300	600	Hinode Elec.	600FH-300S
	160	SV160iH-4U	400	500	400	460	300	600	Hinode Elec.	600FH-300S
	220	SV220iH-4U	-	-	600	460	600	600	Hinode Elec.	600SPF-600UL

3. OVERLOAD PROTECTION

OC Limit : Inverter shuts off its output when inverter output current exceeds its overload trip level (FUN-49 OC lim. Level)for overload trip time. (FUN-50 OC lim.time)

4. OVER SPEED PROTECTION

“Not Provided With Overspeed Protection”.

Leader in Electrics & Automation

LS Industrial Systems Co., Ltd.

10310000290

■ HEAD OFFICE

Yonsei Jaedan Severance Bldg. 84-11 5ga, Namdaemun-ro,
Jung-gu Seoul 100-753, Korea
Tel. (82-2)2034-4643~4649
Fax. (82-2)2034-4879, 2034-4885
<http://www.lsis.biz>

• LS Industrial Systems Tokyo Office >> Japan

Address: 16F, Higashi-Kan, Akasaka Twin Towers 17-22, 2-chome, Akasaka,
Minato-ku Tokyo 107-8470, Japan
Tel: 81-3-3582-9128 Fax: 81-3-3582-0065 e-mail: dongjins@lsis.biz

• LS Industrial Systems Dubai Rep. Office >> UAE

Address: P.O.Box-114216, API World Tower, 303B, Sheikh Zayed road,
Dubai, UAE.
Tel: 971-4-3328289 Fax: 971-4-3329444 e-mail: hwyim@lsis.biz

• LS-VINA Industrial Systems Co., Ltd. >> Vietnam

Address: LSIS VINA Congty che tao may dien Viet-Hung Dong Anh Hanoi,
Vietnam
Tel: 84-4-882-0222 Fax: 84-4-882-0220 e-mail: srjo@hn.vnn.vn

• LS Industrial Systems Hanoi Office >> Vietnam

Address: Room C21, 5Th Floor, Horison Hotel, 40 Cat Linh , Hanoi, Vietnam
Tel: 84-4-736-6270/1 Fax: 84-4-736-6269

• Dalian LS Industrial Systems Co., Ltd. >> China

Address: No. 15 LiaoheXi 3 Road, economic and technical development zone,
Dalian, China
Tel: 86-411-8273-7777 Fax: 86-411-8730-7560 e-mail: lixk@lgis.com.cn

• LS Industrial Systems International Trading (Shanghai) Co., Ltd. >> China

Address: Room 1705-1707, 17th Floor Xinda Commercial Building No 322,
Xian Xia Road Shanghai, China
Tel: 86-21-6278-4291 Fax: 86-21-6278-4372 e-mail: xuhg@lgis.com.cn

• LS Industrial Systems (Wuxi) Co., Ltd. >> China

Address: 102-A National High&New Tech Industrial Development Area, Wuxi,
Jiangsu, China
Tel: 86-510-534-6666 Fax: 86-510-522-4078 e-mail: Xuhg@lgis.com.cn

• LS Industrial Systems Beijing Office >> China

Address: Room 602, North B/D EAS, 21 Xiao Yun Road, Dongsanhuan Beilu,
Chaoyang District Beijing 100027, China
Tel: 86-10-6462-3254 Fax: 86-10-6462-3236 e-mail: linsz@lgis.com.cn

• LS Industrial Systems Guangzhou Office >> China

Address: Room 1403, 14F, New Poly Tower, 2 Zhongshan Liu Road,
Guangzhou, China
Tel: 86-20-8326-6754 Fax: 86-20-8326-6287 e-mail: zhangch@lgis.com.cn

• LS Industrial Systems Chengdu Office >> China

Address: Room 2907, Zhong Yin B/D, No. 35, RenminZhong(2)-Road,
Chengdu, China
Tel: 86-28-8612-9151 Fax: 86-28-8612-9236 e-mail: hongkonk@vip.163.com

• LS Industrial Systems Qingdao Office >> China

Address: 7B40, Haixin Guangchang Shenye Building B, No. 9,
Shandong Road Qingdao, China
Tel: 86-532-580-2539 Fax: 86-532-583-3793 e-mail: bellkuk@hanmail.net

※ LS Industrial Systems constantly endeavors to improve its product so that information in this manual is subject to change without notice

SV-IH /