

## Right choice for ultimate yield

LSIS strives to maximize customers' profit in gratitude of choosing us for your partner.

Programmable Logic Controller

# XG5000 Software

XGT Series

User's Manual

For XGI/XGR/XEC



## Safety Instructions

- Read this manual carefully before installing, wiring, operating, servicing or inspecting this equipment.
- Keep this manual within easy reach for quick reference.

**LS** Industrial Systems

<http://eng.lsis.biz>

### Before using the product ...

For your safety and effective operation, please read the safety instructions thoroughly before using the product.



- ▶ Safety Instructions should always be observed in order to prevent accident or risk with the safe and proper use the product.
- ▶ Instructions are separated into “Warning” and “Caution”, and the meaning of the terms is as follows;



This symbol indicates the possibility of serious injury or death if some applicable instruction is violated



This symbol indicates the possibility of slight injury or damage to products if some applicable instruction is violated

- ▶ The marks displayed on the product and in the user’s manual have the following meanings.
  -  Be careful! Danger may be expected.
  -  Be careful! Electric shock may occur.
- ▶ The user’s manual even after read shall be kept available and accessible to any user of the product.

# Revision History

Version	Date	Remark	Revised Page
V 1.0	'05.03	First Edition	-
V 1.1	'05.05	Word revised and detailed description added	-
V 2.0	'06.12	XGI-CPUU added	-
V 2.1	'08.3	XGR-CPUH added	-
V 2.2	'08.8	PID monitor added	CH.11
V 2.3	'09.10	1. XG5000 installation modified	1-4~1-8
		2. Option modified	2-28, 2-34
		3. Making new project modified	3-3
		4. Direct variable comment modified	4-2~4-3
		5. Export to file added	4-38, 4-56, 4-73, 4-88
		6. EXTERNAL variable added	4-39, 4-57
		7. Sharing variable added	4-89~4-96
		8. OR contact modified	5-4
		9. Input variable/device modified	5-5~5-14
		10. View variable/comment modified	5-39
		11. LD screen properties modified	5-41
		12. Basic parameter modified	9-3, 9-7
		13. I/O Skip modified	10-45~10-52
		14. Fault mask modified	10-53~10-54
		15. Module changing wizard modified	10-55
		16. User event modified	10-62~10-72
		17. Registering monitor modified	11-12~11-16
		18. Show/Hide frame modified	11-39
		19. Trend monitor setting modified	11-79

Version	Date	Remark	Revised Page
		20. Print setting modified	14-10~14-11
		21. Making user function/function block I/O variable	15-5
		22. Clear PLC added at Program Writing window	10-14
		23. Adjust of User function/function block width	15-2, 15-3
		24. Event input module added	19-1, 9-31
		25. Coil added	5-16

※ The number of User's manual is indicated right part of the back cover.

© LS Industrial Systems Co., Ltd 2007 All Rights Reserved.



## About User's Manual

---

### About User's Manual

Thank you for purchasing PLC of LS Industrial System Co., Ltd.

Before use, make sure to carefully read and understand the User's Manual about the functions, performances, installation and programming of the product you purchased in order for correct use and importantly, let the end user and maintenance administrator to be provided with the User's Manual.

The User's Manual describes the product. If necessary, you may refer to the following description and order accordingly. In addition, you may connect our website(<http://eng.lsis.biz/>) and download the information as a PDF file.

#### Relevant User's Manuals

Title	Description	No. of User's Manual
XGI / XGR/ XEC Instructions & Programming	It is the user's manual for programming to explain how to use commands that are used PLC system with XGI CPU, XGR CPU module and XEC basic unit	10310000833
XGI-CPU User's Manual (XGI-CPUU/CPUH/CPUS)	Describes on CPU module, power module, base, I/O module, specification of expansion cable, system configuration and EMC compliance	10310000832
XGR redundancy user manual	Describes on CPU module, power module, base, I/O module, specification of expansion cable, system configuration and EMC compliance	10310001059

# Table of Contents

## **Chapter 1 Introduction..... 1-1 ~ 1-21**

1.1 Features of XG5000.....	1-1
1.2 System Requirements necessary for XG5000.....	1-3
1.3 Installation of XG5000.....	1-4
1.4 Installation of USB Device Driver.....	1-10
1.5 Confirmation of Installed USB Device Driver.....	1-14

## **Chapter 2 Basic Application..... 2-1 ~ 2-40**

2.1 Screen Configuration.....	2-1
2.1.1 Menu Configuration.....	2-2
2.1.2 Tool Box.....	2-8
2.1.3 Status Display Line.....	2-11
2.1.4 Change View Window.....	2-11
2.1.5 Application of Dialog Box.....	2-14
2.2 Open/Close Project.....	2-16
2.2.1 Open Project.....	2-16
2.2.2 Close Project.....	2-16
2.2.3 Save Project.....	2-16
2.3 Convenient Edit Functions.....	2-17
2.3.1 Cut-Paste.....	2-17
2.3.2 Copy - Paste.....	2-18
2.3.3 Drag & Drop.....	2-20
2.4 Shortcut Setting.....	2-23
2.5 Edit Window Zoom In, Zoom Out.....	2-25
2.6 Options.....	2-27
2.6.1 Option Configuration.....	2-27
2.6.2 Option Configuration.....	2-28
2.6.3 Option Configuration.....	2-29
2.6.4 XG5000 font/color option.....	2-30
2.6.5 XG5000 online option.....	2-31
2.6.6 LD option.....	2-34
2.6.7 LD Font/Color option.....	2-35
2.6.8 SFC option.....	2-36
2.6.9 SFC Font/Color.....	2-37
2.6.10 ST option.....	2-38
2.6.11 ST Font/Color.....	2-35

## **Chapter 3 Project..... 3-1 ~ 3-38**

3.1 Project Configuration.....	3-1
3.2 Project File Management.....	3-3
3.2.1 New Project.....	3-3
3.2.2 Open Project.....	3-5

3.2.3 Open from PLC .....	3-5
3.2.4 Save Project .....	3-6
3.2.5 Save as .....	3-7
3.3 Open GMWIN File .....	3-9
3.3.1 Open GMWIN File .....	3-9
3.3.2 GMWIN Project Conversion Rules .....	3-10
3.4 Project Item.....	3-18
3.4.1 Add item .....	3-18
3.4.2 Import item from file .....	3-24
3.4.3 Export to file .....	3-27
3.4.4 Item register information .....	3-29
3.4.5 Change program sequence.....	3-31
3.5 Compare Project.....	3-32
3.6 Project Password.....	3-34
3.6.1 Input password.....	3-34
3.6.2 Change password.....	3-36
3.6.3 Delete password .....	3-37

<b>Chapter 4 Variable .....</b>	<b>4-1 ~ 4-96</b>
---------------------------------	-------------------

4.1 Global/Direct Variable .....	4-1
4.1.1 Global Variable .....	4-1
4.1.2 Direct Variable Comment .....	4-2
4.1.3 Flag.....	4-4
4.2 Global/Direct Variable Edit.....	4-6
4.2.1 Global/Direct Variable Registration.....	4-6
4.2.2 Copy, Cut, Delete and Paste.....	4-8
4.2.3 Insert line.....	4-11
4.2.4 Delete line .....	4-13
4.2.5 Automatic fill .....	4-14
4.2.6 Drag & Drop.....	4-16
4.2.7 Undo/Redo .....	4-18
4.2.8 Export to file .....	4-19
4.2.9 Register Special Module Variables.....	4-20
4.2.10 Preview .....	4-22
4.2.11 Print .....	4-23
4.2.12 Convenient Functions.....	4-23
4.3 Local Variable .....	4-25
4.3.1 Local Variable .....	4-25
4.4 Local Variable Edit .....	4-26
4.4.1 Local Variable Registration.....	4-26
4.4.2 Copy, Cut, Delete and Paste.....	4-28
4.4.3 Insert line.....	4-31
4.4.4 Delete line .....	4-33
4.4.5 Automatic fill .....	4-34
4.4.6 Drag & Drop.....	4-36
4.4.7 Undo/Redo .....	4-37
4.4.8 Export to file .....	4-38
4.4.9 Add EXTERNAL Variable.....	4-39

## Table of Contents

4.5 FB Variable .....	4-42
4.5.1 FB Variable .....	4-42
4.6 FB Variable Edit.....	4-43
4.6.1 FB Variable Registration.....	4-43
4.6.2 Copy, Cut, Delete and Paste.....	4-45
4.6.3 Insert line.....	4-48
4.6.4 Delete line .....	4-50
4.6.5 Automatic fill .....	4-51
4.6.6 Drag & Drop.....	4-53
4.6.7 Undo/Redo .....	4-55
4.6.8 Export to file .....	4-56
4.6.9 Add EXTERNAL Variable.....	4-57
4.7 FUN Variable .....	4-60
4.7.1 FUN Variable .....	4-60
4.8 FUN Variable Edit .....	4-61
4.8.1 FUN Variable Registration.....	4-61
4.8.2 Copy, Cut, Delete and Paste.....	4-63
4.8.3 Insert line.....	4-66
4.8.4 Delete line .....	4-67
4.8.5 Automatic fill .....	4-69
4.8.6 Drag & Drop.....	4-71
4.8.7 Undo/Redo .....	4-73
4.8.8 Export to file .....	4-73
4.9 Data type edit .....	4-75
4.9.1 Data Type Registration.....	4-75
4.9.2 Copy, Cut, Delete and Paste.....	4-77
4.9.3 Insert line.....	4-80
4.9.4 Delete line .....	4-82
4.9.5 Automatic fill .....	4-83
4.9.6 Drag & Drop.....	4-85
4.9.7 Undo/Redo .....	4-87
4.9.8 Export to file .....	4-88
4.10 Sharing Variable.....	4-89
4.10.1 Saving variable/comment.....	4-89
4.10.2 CSV file structure .....	4-92
4.10.3 Import external variable in XG-PD.....	4-93

## **Chapter 5 LD Edit ..... 5-1 ~ 5-54**

5.1 Limit.....	5-1
5.2 Program Edit .....	5-1
5.2.1 Edit Tools.....	5-1
5.2.2 Input Contact point.....	5-3
5.2.3 Input OR contact point .....	5-4
5.2.4 Input Variable/Device.....	5-5
5.2.5 Input Line .....	5-15
5.2.6 Input Coil.....	5-16
5.2.7 Input Function(block) .....	5-17
5.2.8 Favorite Function(Block).....	5-18

5.2.9 Input Comment .....	5-22
5.2.10 Input Label .....	5-25
5.2.11 Insert Extended Function .....	5-27
5.2.12 Insert Cell .....	5-28
5.2.13 Insert Line .....	5-29
5.2.14 Delete Factor .....	5-29
5.2.15 Delete Cell .....	5-30
5.2.16 Delete Line .....	5-31
5.2.17 Copy/Cut/Paste .....	5-31
5.2.18 Undo and Redo .....	5-33
5.2.19 Program Edit Mode .....	5-34
5.3 View Program .....	5-36
5.3.1 View IL Program .....	5-36
5.3.2 Program Magnification Change .....	5-37
5.3.3 View Device .....	5-38
5.3.4 View Variable .....	5-38
5.3.5 View Device/Variable .....	5-38
5.3.6 View Device/Comment .....	5-39
5.3.7 View Variable/Comment .....	5-39
5.3.8 Adjust No. of Contact Point .....	5-40
5.3.9 LD Screen Properties .....	5-41
5.4 Edit Function Additional .....	5-43
5.4.1 Block Mask Instruction .....	5-43
5.4.2 Bookmark .....	5-45
5.4.3 Go To .....	5-51

<b>Chapter 6 SFC Edit .....</b>	<b>6-1 ~ 6-49</b>
---------------------------------	-------------------

6.1 Limit .....	6-1
6.2 Program Edit .....	6-1
6.2.1 Edit Tools .....	6-1
6.2.2 Input step/transition .....	6-2
6.2.3 Input Action .....	6-3
6.2.4 Input Block/Transition .....	6-4
6.2.5 Input label .....	6-5
6.2.6 Input Jump .....	6-6
6.2.7 Input left branch .....	6-7
6.2.8 Input right branch .....	6-10
6.2.9 Edit Step Property .....	6-12
6.2.10 Transition property .....	6-13
6.2.11 Action property .....	6-14
6.2.12 Edit Block Property .....	6-18
6.2.13 Edit label property .....	6-19
6.2.14 Jump property .....	6-20
6.2.15 Set Branch Priority .....	6-22
6.2.16 Erase Branch Priority .....	6-23
6.2.17 Delete Factor .....	6-24
6.2.18 Copy/Cut/Paste .....	6-24
6.2.19 Undo and Redo .....	6-28

## Table of Contents

6.2.20 Program Edit Mode .....	6-29
6.3 View Program.....	6-30
6.3.1 Program zoom In/Out .....	6-30
6.3.2 SFC Property.....	6-31
6.3.3 View Block/Action/Transition List .....	6-37
6.3.4 Open Action/Transition .....	6-38
6.3.5 Devices/Variables.....	6-38
6.3.6 Devices/Comments .....	6-39
6.3.7 Adjust Contact No. ....	6-39
6.3.8 LD Properties.....	6-40
6.4 Edit additional Function .....	6-42
6.4.1 Bookmark .....	6-42
6.4.2 Go To.....	6-46

## **Chapter 7 Programming Convenience ..... 7-1 ~ 7-30**

7.1 Cross Reference .....	7-1
7.1.1 View All Device .....	7-1
7.1.2 Output Cross Reference Instantly .....	7-3
7.1.3 Check Duplicated Coil Instantly .....	7-5
7.2 Used Device .....	7-7
7.2.1 Execute Used Device .....	7-7
7.2.2 View Device Uses .....	7-8
7.3 Check Program.....	7-10
7.3.1 Check Program Setting .....	7-10
7.3.2 Check Result Trace .....	7-14
7.3.3 Logic Error .....	7-15
7.3.4 Grammar Error .....	7-19

## **Chapter 8 Find/Replace ..... 8-1 ~ 8-27**

8.1 Find Device.....	8-1
8.1.1 Find Next Device.....	8-3
8.1.2 Find All Device.....	8-5
8.2 Find Text.....	8-7
8.2.1 Find Text.....	8-9
8.2.2 Find All String.....	8-11
8.3 Replace Device.....	8-14
8.3.1 Replace Device.....	8-16
8.3.2 Replace All Device .....	8-19
8.4 Replace String .....	8-22
8.4.1 Replace String .....	8-23
8.4.2 Replace All String .....	8-25
8.5 Find Again.....	8-27

**Chapter 9 Parameter ..... 9-1 ~ 9-25**

9.1 Basic Parameter .....	9-1
9.2 I/O Parameters.....	9-7
9.2.1 Base Module Information Setting .....	9-8
9.2.2 Module Information Setting Based on Slots .....	9-9
9.2.3 I/O Parameter Edit Function .....	9-11
9.2.4 Detailed Module Information Setting .....	9-16
9.2.5 I/O Parameter Print Function .....	9-24

**Chapter 10 Online..... 10-1 ~ 10-81**

10.1 Connect Options.....	10-1
10.1.1 Local Connect Setting .....	10-1
10.1.2 Remote 1 Connect Setting.....	10-4
10.1.3 Remote 2 Connect Setting.....	10-7
10.2 Connect/Disconnect .....	10-9
10.2.1 Connect .....	10-9
10.3 Write.....	10-14
10.4 Read .....	10-16
10.5 Change Mode .....	10-17
10.6 Compare to PLC.....	10-18
10.7 Reset PLC.....	10-19
10.8 Clear PLC.....	10-20
10.8.1 Clear Item .....	10-20
10.8.2 Clear Memory .....	10-21
10.9 PLC Information.....	10-22
10.9.1 CPU Information .....	10-22
10.9.2 CPU Performance .....	10-23
10.9.3 Password.....	10-25
10.9.4 PLC RTC Setting .....	10-27
10.10 PLC History.....	10-28
10.10.1 Error Log.....	10-28
10.10.2 Change Mode History .....	10-29
10.10.3 Shut down Log History.....	10-30
10.10.4 System Log.....	10-31
10.11 PLC Error/Warning .....	10-32
10.12 Flash Memory Setting.....	10-34
10.13 Forced I/O Setting.....	10-36
10.14 Skip I/O.....	10-45
10.15 Fault Mask.....	10-53
10.16 Module Changing Wizard .....	10-55
10.17 Custom Events .....	10-62
10.17.1 Example.....	10-60
10.17.2 Event Setting.....	10-67
10.17.3 Event History.....	10-77

## Table of Contents

### Chapter 11 Monitoring ..... 11-1 ~ 11-120

11.1 Monitoring .....	11-1
11.1.1 Start/Stop Monitoring.....	11-1
11.1.2 Change Current Value.....	11-2
11.1.3 Pause Monitoring .....	11-4
11.2 LD Program Monitoring .....	11-7
11.3 Variable Monitoring .....	11-10
11.3.1 Register Monitoring.....	11-11
11.3.2 View.....	11-21
11.3.3 Operation of Monitoring .....	11-23
11.3.4 Find.....	11-24
11.3.5 Print .....	11-24
11.3.6 Shortcut Keys .....	11-25
11.3.7 Alignment .....	11-25
11.4 System Monitoring .....	11-27
11.4.1 Basic Application .....	11-27
11.4.2 Connect/Disconnect.....	11-28
11.4.3 System Synchronization.....	11-28
11.4.4 All I/O modules ON/OFF.....	11-29
11.4.5 Selected I/O modules ON/OFF .....	11-29
11.4.6 Change Current Value.....	11-30
11.4.7 Information Display of Power Module .....	11-31
11.4.8 Information Display of CPU module.....	11-32
11.4.9 Information Display of Communication Module .....	11-33
11.4.10 Information of Special Module .....	11-34
11.4.11 Start/Stop Monitoring.....	11-35
11.4.12 Special Module Monitoring.....	11-35
11.4.13 Save .....	11-37
11.4.14 Open .....	11-37
11.4.15 Move Base .....	11-37
11.4.16 Preview .....	11-38
11.4.17 Hide/Show Frame.....	11-39
11.5 Device Monitoring .....	11-40
11.5.1 Basic Application .....	11-40
11.5.2 Device Areas .....	11-41
11.5.3 Data Format and Display Items .....	11-42
11.5.4 Edit Data .....	11-53
11.5.5 Save Device .....	11-55
11.5.6 Open Device.....	11-57
11.5.7 Data Value Setting.....	11-58
11.5.8 Clear Data.....	11-62
11.5.9 Write to PLC .....	11-63
11.5.10 Read from PLC .....	11-64
11.5.11 Write Selected Area on PLC .....	11-65
11.5.12 Start/Stop Monitoring.....	11-66
11.5.13 Change Current Value.....	11-66
11.5.14 PLC Type Settings.....	11-67



11.5.15 Screen Zoom-In/Zoom-Out.....	11-68
11.5.16 Automatic Width/Height Adjustment.....	11-69
11.5.17 View Properties .....	11-69
11.5.18 Page Setting.....	11-70
11.6 Special Module Monitoring.....	11-72
11.7 Trend Monitoring.....	11-76
11.7.1 Start Trend Monitoring.....	11-76
11.7.2 Setting Trend Monitoring.....	11-77
11.7.3 Setting graph.....	11-80
11.7.4 Setting Graph Window.....	11-83
11.7.5 Graph function.....	11-84
11.8 Data Traces.....	11-89
11.8.1 Connect.....	11-91
11.8.2 Trace Setting.....	11-91
11.8.3 Setting Graph.....	11-96
11.8.4 Trace.....	11-98
11.8.5 Animation.....	11-99
11.8.6 Graph Function.....	11-100
11.8.7 File function.....	11-100
11.8.8 View Function.....	11-101
11.9 PID Monitor.....	11-105
11.9.1 Basic instructions.....	11-105
11.9.2 Save file.....	11-107
11.9.3 Open file.....	11-109
11.9.4 Setting/adjustment of loop name.....	11-111
11.9.5 Add/Delete selected loop.....	11-112
11.9.6 Print/Print Preview.....	11-113
11.9.7 Connection to PLC.....	11-113
11.9.8 Write loop data to PLC.....	11-114
11.9.9 Write all data to PLC.....	11-114
11.9.10 Read loop data from PLC.....	11-114
11.9.11 Read all data from PLC.....	11-115
11.9.12 Monitor start/end.....	11-115
11.9.13 Change current value during monitoring.....	11-116
11.9.14 Graph.....	11-117
11.9.15 Graph related function.....	11-117
11.9.16 Edit function.....	11-119

<b>Chapter 12 Debugging .....</b>	<b>12-1 ~ 12-19</b>
-----------------------------------	---------------------

12.1 Start/Stop Debugging.....	12-1
12.1.1 Start Debugging.....	12-1
12.1.2 Stop Debugging.....	12-1
12.2 LD Program Debugging.....	12-2
12.2.1 Set/Remove Breakpoints.....	12-2
12.2.2 Go.....	12-5
12.2.3 Go to Cursor.....	12-6
12.2.4 Step Into.....	12-7
12.3 List of Break Points.....	12-13

## Table of Contents

12.4 Variable Break.....	12-15
12.5 Scan Break.....	12-18

### **Chapter 13 Online Editing..... 13-1 ~ 13-4**

13.1 Sequence of Online Editing.....	13-1
13.1.1 Sequence of Online Editing.....	13-1

### **Chapter 14 Print..... 14-1 ~ 14-11**

14.1 Print Project.....	14-1
14.1.1 Print Setting.....	14-2
14.1.2 Page Setup.....	14-3
14.1.3 Header/Footer Setting.....	14-4
14.1.4 Cover Setup.....	14-6
14.2 LD Program Print.....	14-10
14.2.1 Print Setting.....	14-10
14.2.2 Preview.....	14-11

### **Chapter 15 User Function/Function Block..... 15-1 ~ 15-10**

15.1 Create User Function/Function Block.....	15-2
15.1.1 Create User Function/Function Block Program.....	15-2
15.1.2 Create User Function/Function Block I/O Variable.....	15-4
15.1.3 User Function/Function Block Programming.....	15-5
15.2 Use User Function/Function Block.....	15-8

### **Chapter 16 XG-SIM..... 16-1 ~ 16-28**

16.1 Getting Started.....	16-1
16.1.1 Feature of XG-SIM.....	16-1
16.1.2 System Requirements for the Execution of XG-SIM.....	16-2
16.1.3 XG-SIM Execution.....	16-2
16.2 XG-SIM.....	16-4
16.2.1 Program window Configuration.....	16-4
16.2.2 Channel List.....	16-5
16.2.3 I/O Condition.....	16-6
16.2.4 Module Simulation.....	16-18
16.3 Restrictions.....	16-28
16.3.1 Watchdog Timer.....	16-28
16.3.2 COM module.....	16-28

**Chapter 17 ST Edition ..... 17-1 ~ 17-27**

17.1 Writing ST program.....	17-1
17.1.1 Adding Scan Program .....	17-1
17.1.2 Adding User Function/Function Block.....	17-2
17.1.3 Adding SFC transition, action.....	17-4
17.2 Limit.....	17-6
17.3 Editing Program .....	17-6
17.3.1 Shortcut key.....	17-6
17.3.2 Copy/Paste.....	17-7
17.3.3 Undo/Redo .....	17-8
17.3.4 Adding/Selecting variable.....	17-8
17.3.5 Inserting Function/Function Block .....	17-11
17.4 Viewing Program .....	17-13
17.4.1 ST option .....	17-13
17.4.2 Font/Color.....	17-14
17.4.3 Zoom.....	17-15
17.4.4 Tap.....	17-15
17.4.5 Showing line numbers.....	17-16
17.5 Additional Edition Function.....	17-17
17.5.1 Book mark .....	17-17
17.5.2 Selection from character string list.....	17-19
17.5.3 Selecting member variable from character string list.....	17-20
17.5.4 Setting/Removing Block Mask.....	17-21
17.5.5 Setting/Removing Line Block Mask .....	17-23
17.5.6 Indent/Outdent .....	17-25

**Chapter 18 Dedicated XGR Function ..... 18-1 ~ 18-13**

18.1 Redundancy Parameter.....	18-1
18.2 Redundancy PLC State Window .....	18-3
18.3 Control Redundancy .....	18-4
18.3.1 Change of master CPU.....	18-4
18.3.2 Standby CPU control.....	18-5
18.4 System Monitoring.....	18-6
18.4.1 System Configuration .....	18-6
18.4.2 Node Count change .....	18-7
18.4.3 Base information.....	18-8

**Chapter 19 Exclusive Functions for Event Input Module ..... 19-1 ~ 19-31**

19.1 Overview.....	19-1
19.1.1 Characteristics of SOE Monitor .....	19-1
19.1.2 Functions of the SOE Monitor .....	19-1
19.1.3 Files Created in the SOE Monitor.....	19-1
19.2 Screen Configuration.....	19-2

## Table of Contents

---

19.2.1 Menu Structure.....	19-3
19.2.2 Tools .....	19-5
19.2.3 SOE Event History Window .....	19-7
19.2.4 Status Bar .....	19-9
19.3 Basic Parameter Setting .....	19-10
19.3.1 Setting Items.....	19-10
19.4 I/O Parameter Setting.....	19-11
19.4.1 Setting Item .....	19-11
19.5 View Module Information .....	19-17
19.6 Event History Monitor .....	19-18
19.7 Save as an Excel File.....	19-29

## Chapter 1 Introduction

### 1.1 Features of XG5000

XG5000 is a software tool designed to program and debug XGT PLC series with the following features and merits

#### 1) Multi-PLC, Multi-Program

Allows the user to edit, monitor or manage PLC system interlocked with several PLC included in a project at the same time.

And the program can be made as divided into Scan programs and various Task programs

#### 2) Various Drag and Drop

Makes editing easy and convenient with Drag and Drop function on most of editors such as Project, Variable/Comment, LD Edit, Variable Monitor, etc.

#### 3) Setting User's Shortcut Keys

Shortcut Keys provided as default can be changed or added as specified as familiar to a user

#### 4) Various Message Windows

Provides various message windows to edit and inspect program easily.

#### 5) Convenient Variable/Comment Editing

- Edit with MS Excel is available.
- Various types of Edit is available through View Variable, View Device, View Flag, etc.
- Similar kind of Variables can be added easily with Auto-fill.
- Convenient Copy is available on different Variable/Comment Windows with Drag and Drop
- Direct Edit is available without displaying dialog box just like Excel.

### 6) Convenient Program Edit

- Unlimited Undo/Redo function provided..
- Block Edit available in cell unit.
- Screen-divided Edit available.
- Find/Replace function enhanced.
- Execution in rung unit can be prohibited with Block Mask function.
- Convenient access is allowed to a specific position with Bookmark function.
- Memory of selected device can be referred when editing LD

### 7) Various Monitoring Functions

- Various monitoring functions are provided such as variable monitoring, device monitoring, system monitoring, trend monitoring, special module monitoring, etc.

### 8) Custom Events

- If user defined conditions are met for a specific device, logging and reading data is available.

### 9) Module Changing Wizard

- Module can be safely and easily changed during Run without stopping PLC.

## 1.2 System Requirements necessary for XG5000

### 1) Personal Computer and Memory

- A set of computer with Pentium and higher CPU and 128MB and more memory

### 2) COM Port

- RS-232C serial port or USB port is necessary.

### 3) Hard Disk

- At least, 100MB and more space is necessary.

### 4) Mouse

- Mouse to connect with the computer is necessary.

### 5) Monitor

- Monitor should have 1024 x 768 and higher resolution.

### 6) Windows

- Compatible with Windows 2000/XP. However, XG5000 may be shut down if several applications including other programs are executed in Windows 98/ME, due to limited memory. Please execute XG5000, based on Windows 2000 or XP.

### 1.3 Installation of XG5000

[Steps]

1. Execute the installation file. (**XG5000 Version 2.0 or more for IEC**)
2. Installation Wizard will prepare for installation as below.

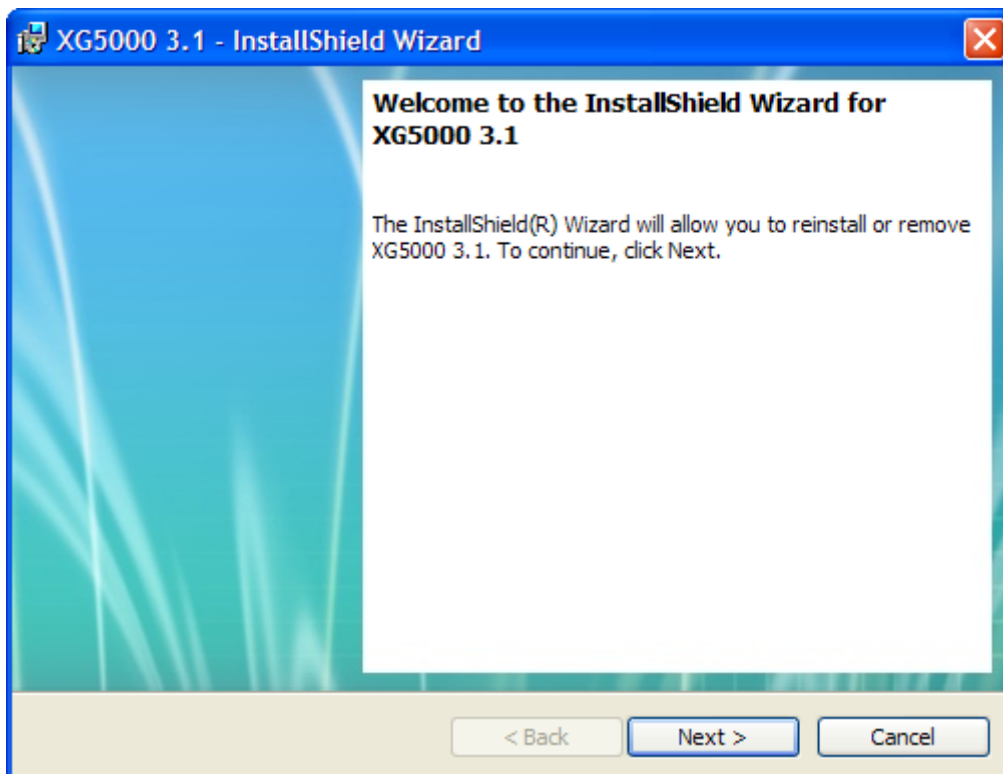

3. Click [Next] button, and it shows License Agreement message.



4. Enter your name and company name and then click [Next] button.

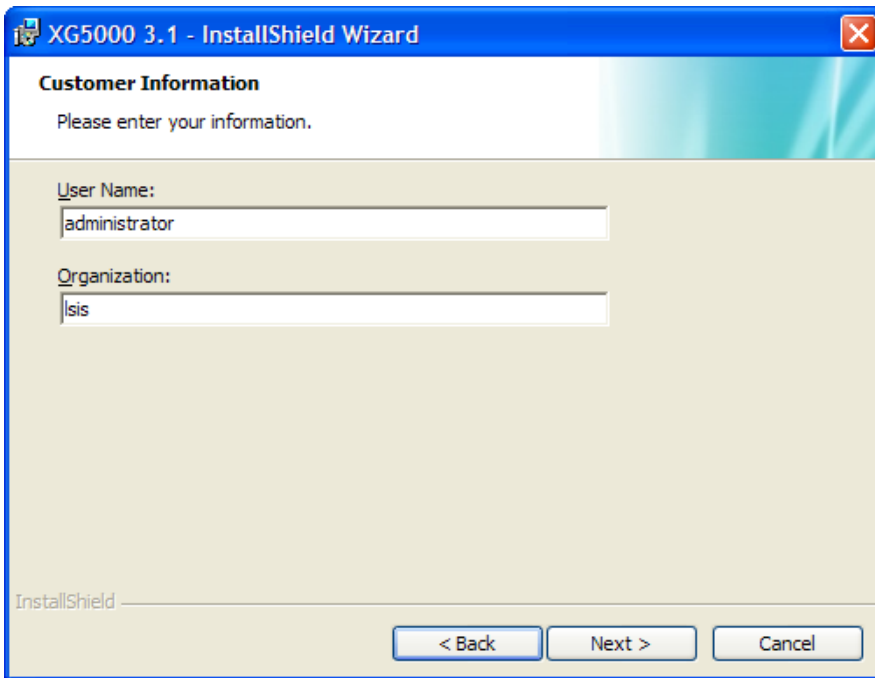

**XG5000 3.1 - InstallShield Wizard**

**Customer Information**  
Please enter your information.

User Name:  
administrator

Organization:  
Isis

InstallShield

< Back    Next >    Cancel

## Chapter 1 Introduction

5. Select a folder to install XG5000 into. If you want to change the folder, click Browse... button and make or select a new folder. XG5000 needs about 30M Bytes of installation space in hard disk, which will ask you to select a disk with enough capacity. If the installation space is not enough, a warning message will be displayed to make the following progress unavailable

6. After a folder is selected, click [Next] button

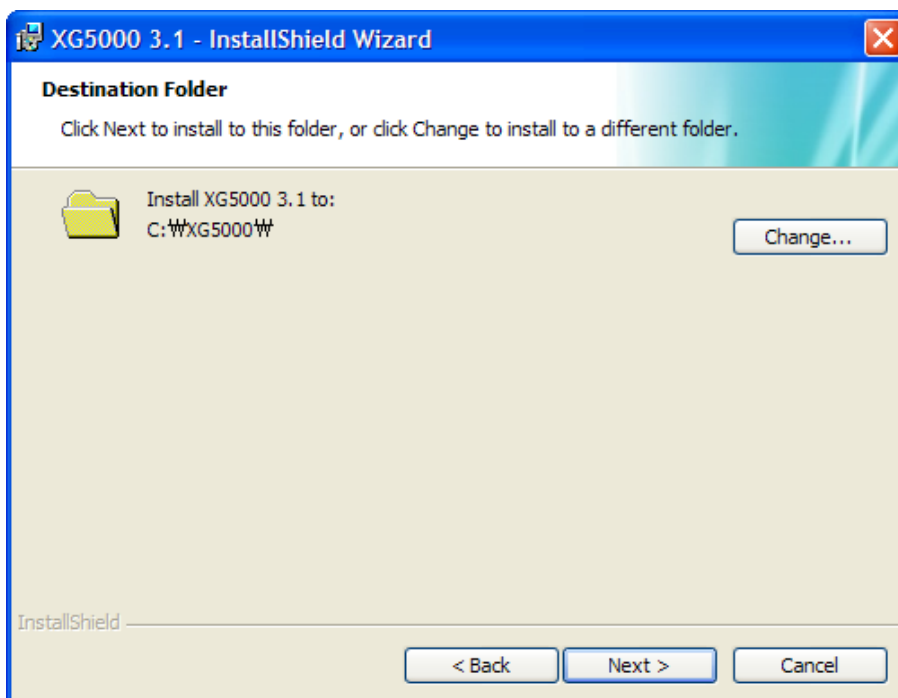

7. Check installation folder and click [Next] button.

8. Installation will be started as shown below.

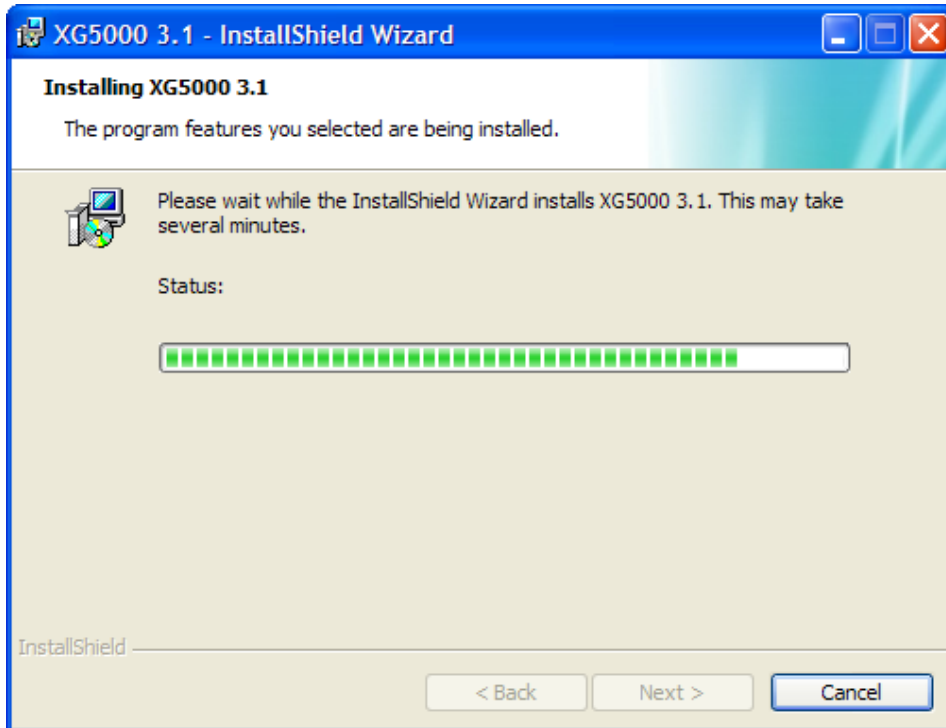

9. Wait a second for the installation to be complete.

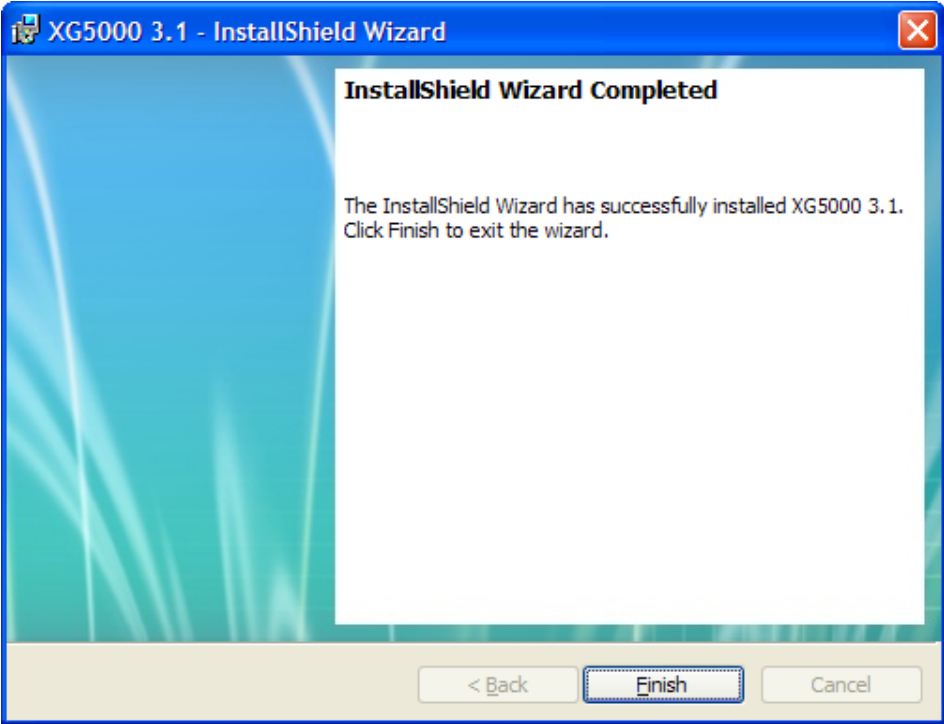

## 1.4 Installation of USB Device Driver

If XG5000 is installed on Windows XP for the first time, It needs USB device driver installation as an additional step. USB device driver shall be also installed as described below.

### Note

- If your OS is Windows 2000, XG5000 will be installed with USB device driver automatically. However, in case of Window XP, the driver shall be additionally installed.

[Steps]

1. Ensure that Drivers folder is created in the folder where XG5000 is installed, and there are 2 driver files of **GmUSB.sys** and **GmUSB.inf** in the Drivers folder. If there is no folder or driver file, reinstall XG5000
2. Turn PLC Power on and connect USB connector with PC. If connection is established, Find New Hardware Wizard Dialog Box will be displayed to ask you to install the device driver

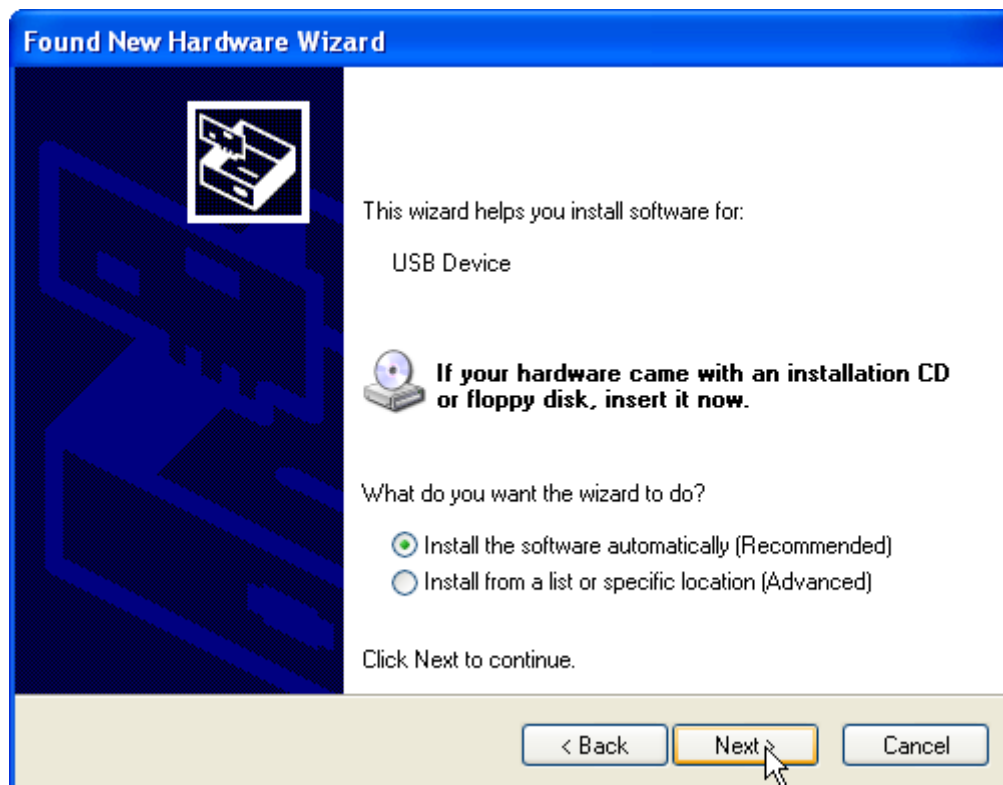

3. From the options of Find New Hardware Wizard Dialog Box, select "Installation from a list or specific location (Advanced)" and click [Next] to continue.



- Among driver searching options, select “Search for the best driver in these locations” and check “Include this location in the search”.

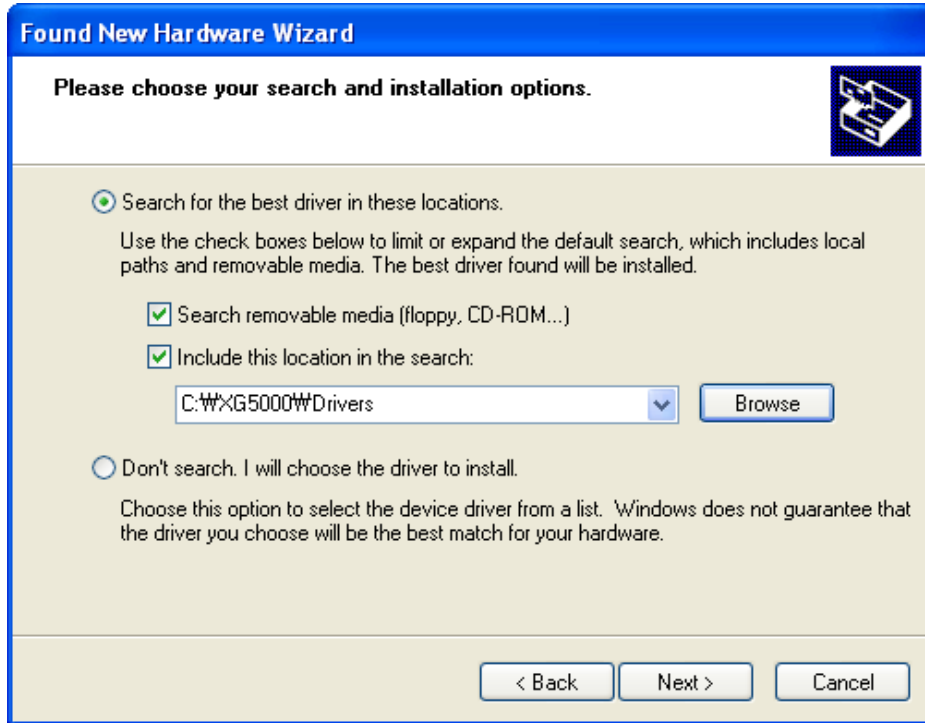

- Click [Browse] button. On Browse Folder Dialog Box, select Drivers' folder where XG5000 is installed

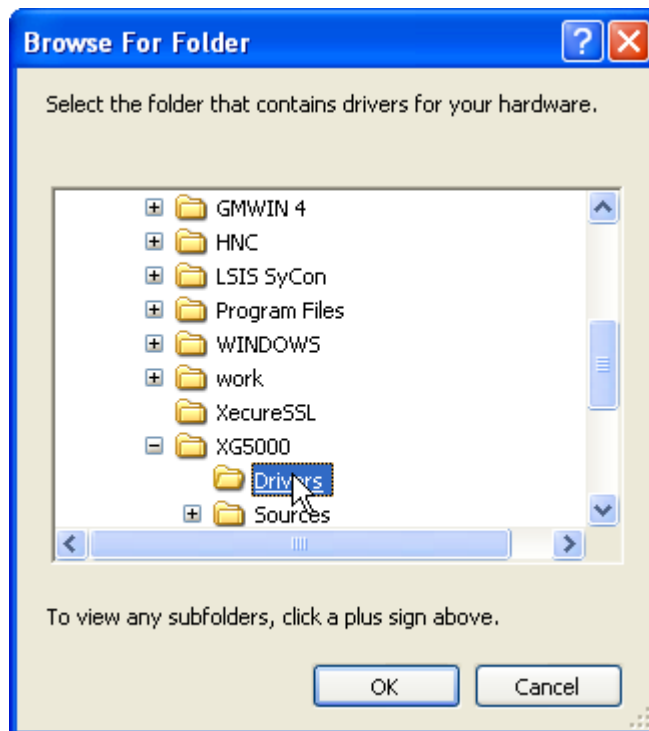

## Chapter 1 Introduction

6. Click [OK] button. Then, a computer starts searching for the driver files in the selected folder.



7. If the computer found the most suitable device driver, you will be asked to decide to install the selected device driver. Since USB device driver operated stably based on Windows OS, you may click [Continue Anyway] button





8. If the device driver has been installed completely, the Installation Complete Dialog Box will be displayed as follows. Click [Finish] button to end the installation of the driver.

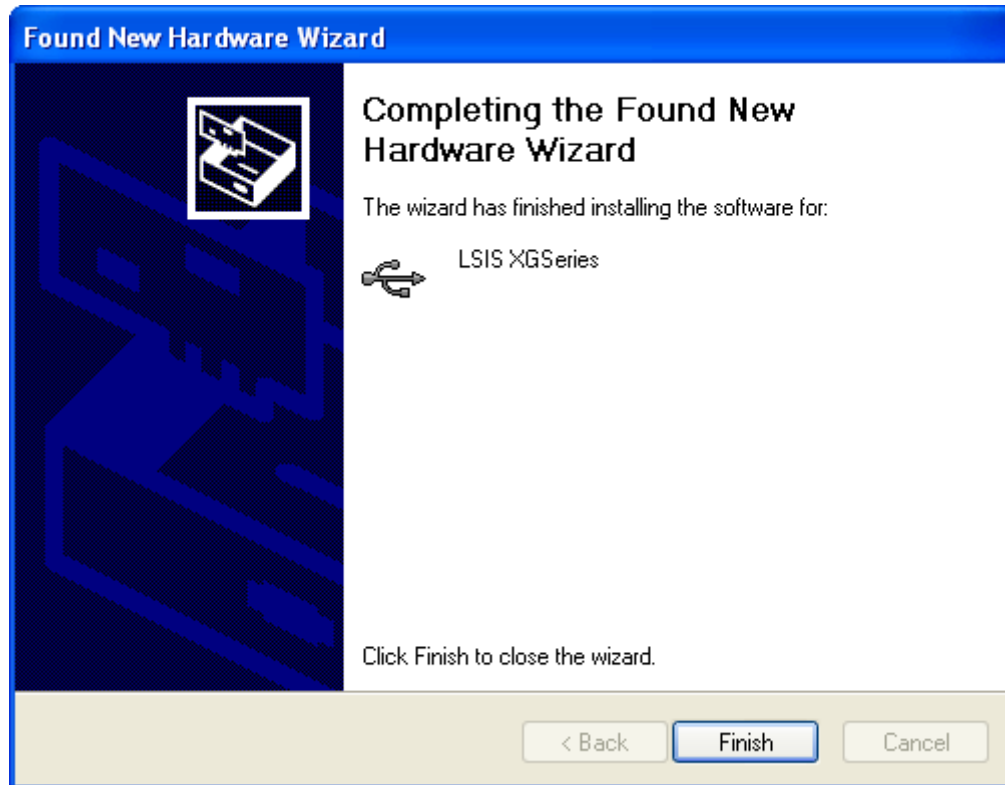

### 1.5 Confirmation of Installed USB Device Driver

If USB connection is not available, check the installation status of the device driver as follows

[Steps]

1. Click the right button of the mouse with the cursor on [My Computer] icon on the background screen, and select [Manage] on the menu

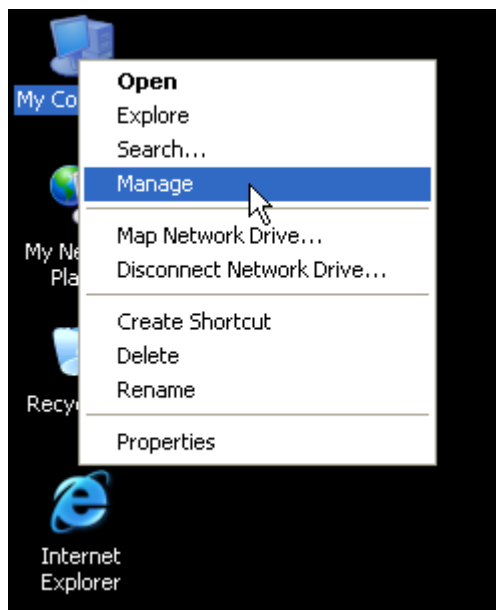

2. Computer Management Dialog Box will be displayed as shown in the figure below. On the left tree list of Dialog Box, click [Computer Management (Local)]-[System Tools]-[Device Manager] in regular order. The items displayed on the right list may be different according to devices installed on the computer.

## 1) Normal Case

The USB device driver for XGT PLC has been installed successfully, if the list [LSIS XG Series] appears with the figure under [Universal Serial Bus Controller].

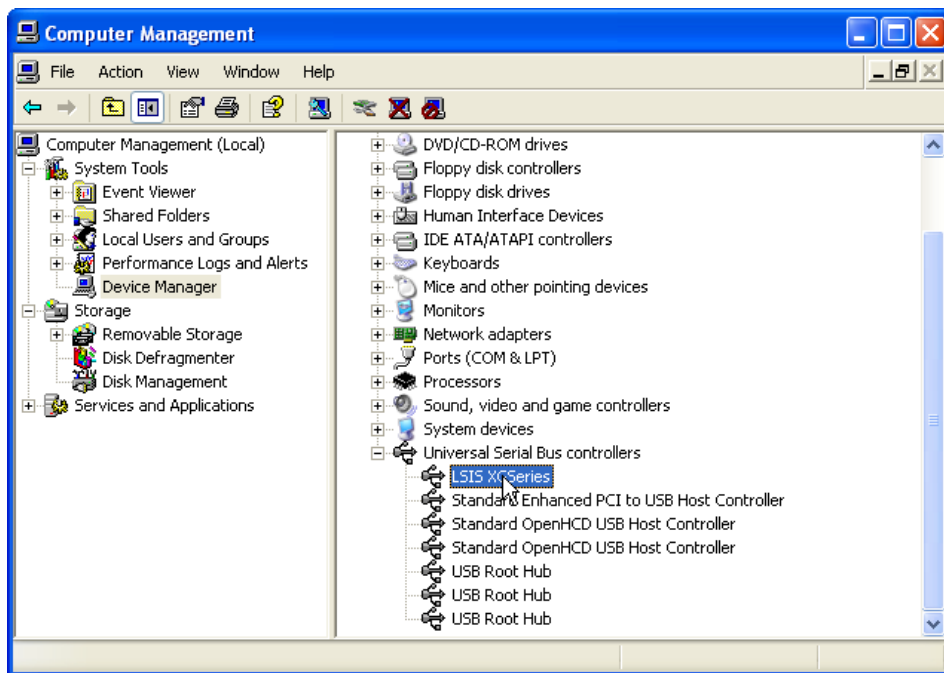

## 2) Abnormal Case

The device driver has not been installed successfully, if the following figure is displayed.

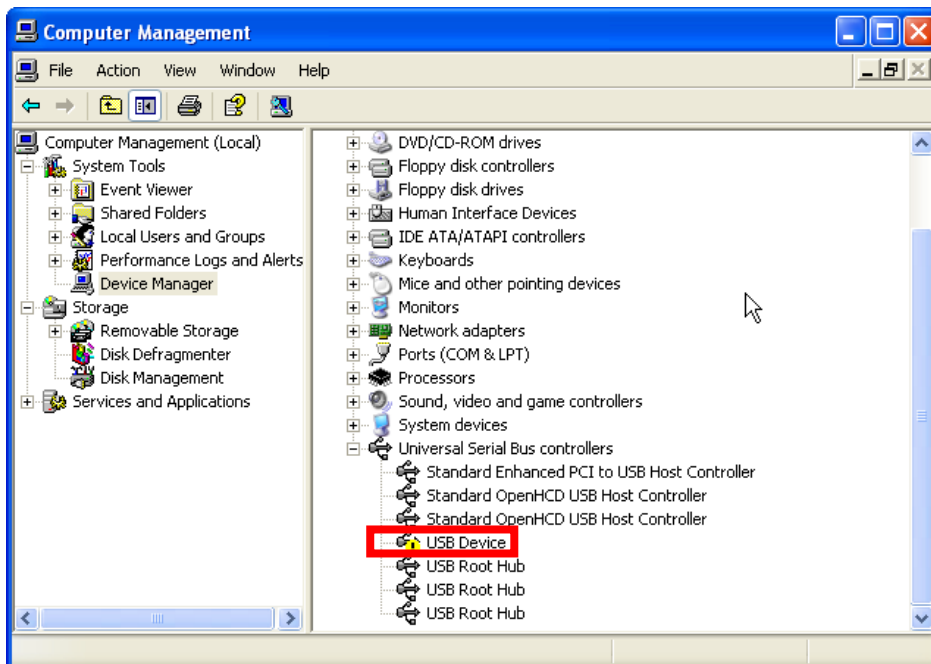

## Chapter 1 Introduction

If the USB driver for XGT PLC is not installed successfully, reinstall the USB driver for XGT PLC in the following steps.

[Steps]

1. On the device driver with the icon with an exclamation mark, click the right button of the mouse. Select [Update Driver] on the menu.

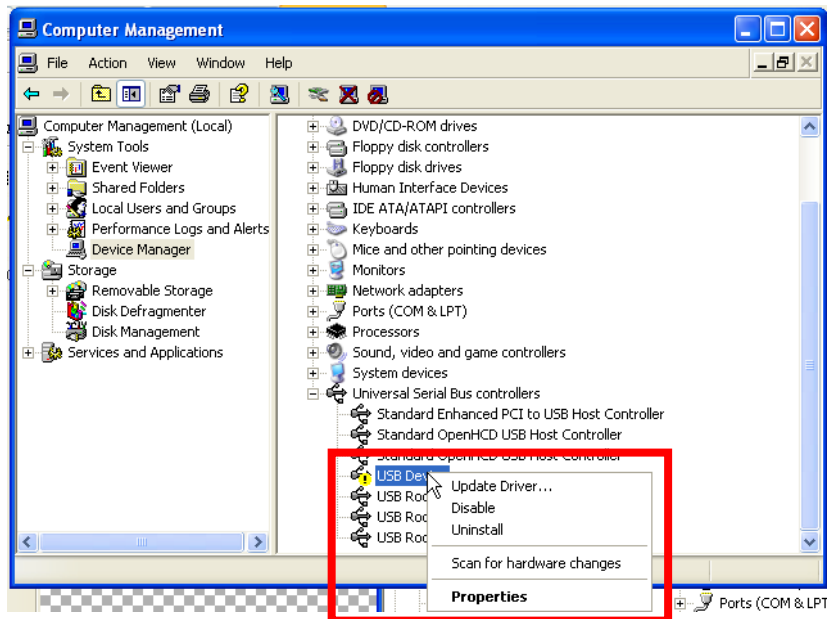

2. H/W Update Wizard Dialog Box will appear. Select the option "Installation from a list or specific location (Advanced)" and click [Next]. The next sequence is manually the same as in Installation of Device Driver.

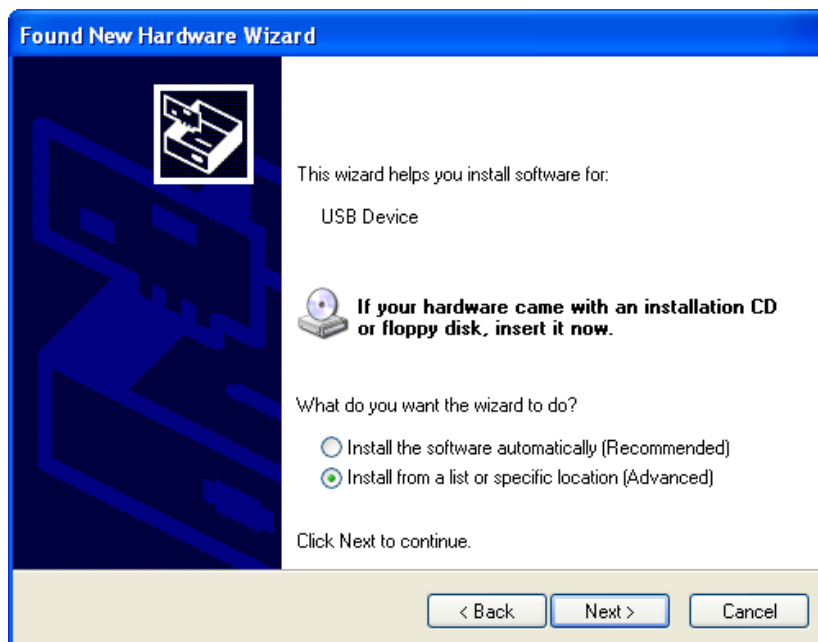

If the USB driver for XGT PLC is not installed successfully, reinstall the USB driver for XGT PLC in the following steps

[Steps]

1. If the device driver has been installed incorrectly or in error, execute H/W Update Wizard. Select the option "Installation from a list or specific location (Advanced)" and click [Next].

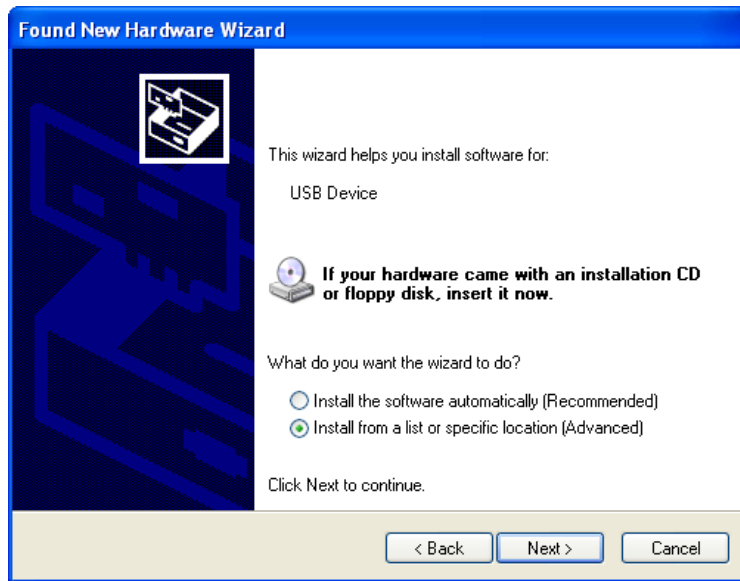

2. On search and installation options, select [Don't Search. I will choose the driver to install.] and click [Next]

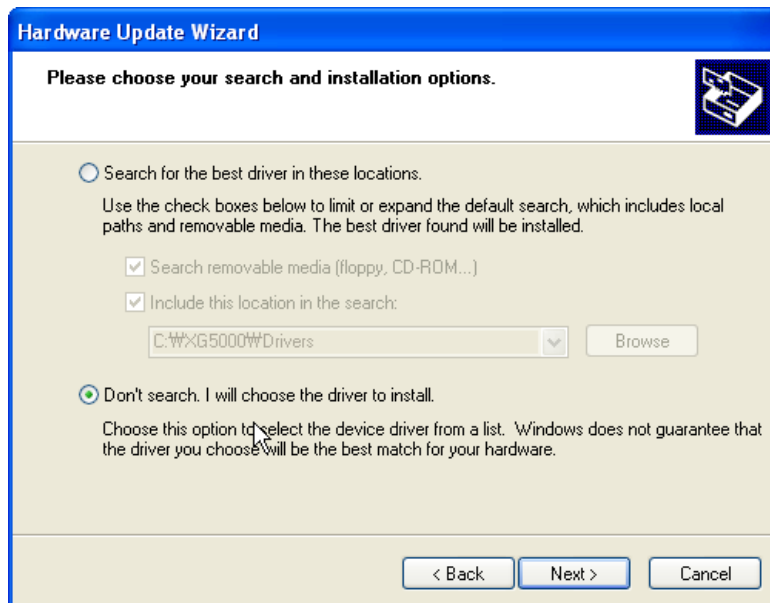

## Chapter 1 Introduction

3. Click [Have Disk...] on the Dialog Box below

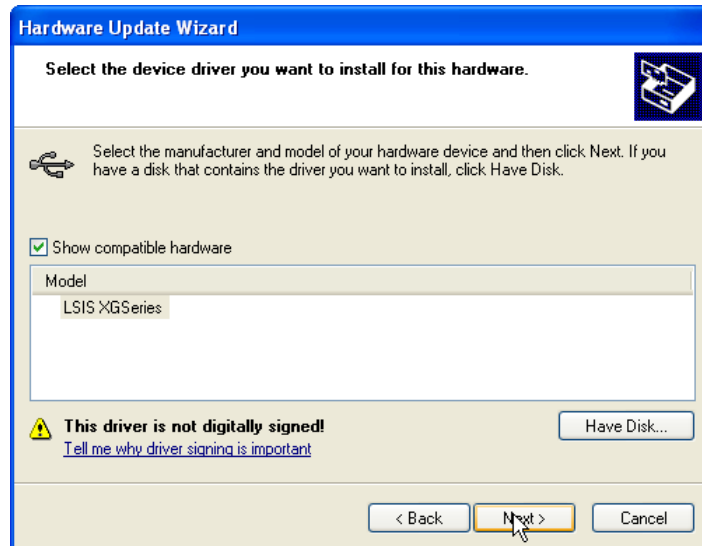

4. If Installation Dialog Box is displayed on the disk, click [Browse] button.

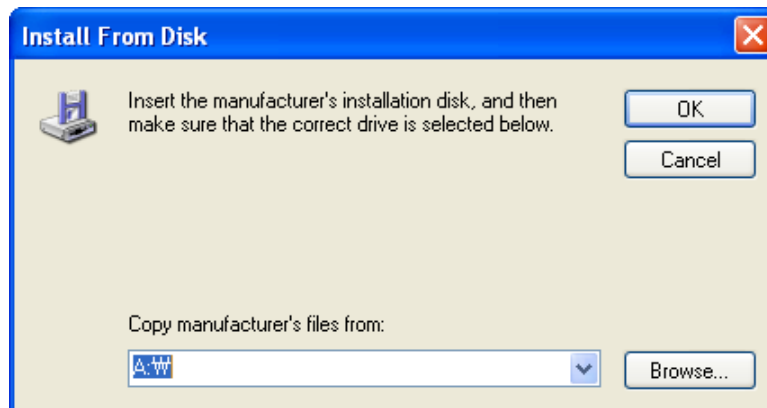

- From the Browse File Dialog Box, move to the folder XG5000 is installed in. Select drivers folder to display **GmUSBD.inf** file. With this file selected, click [Open] button.

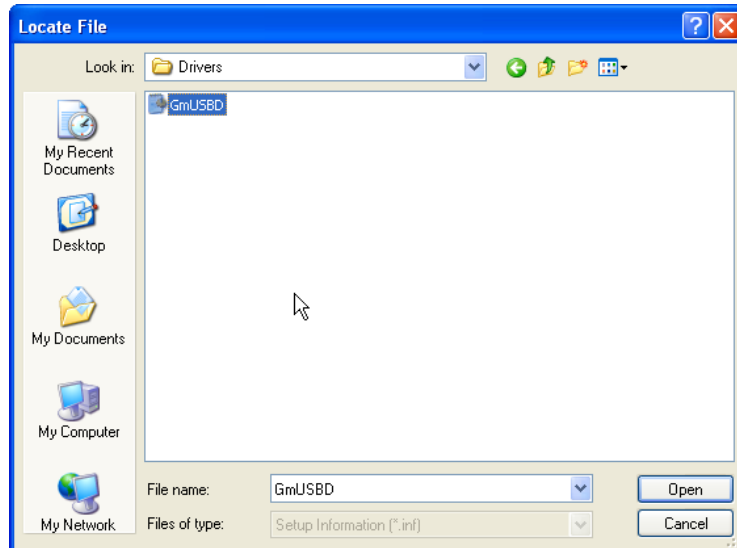

- On the item of 'Copy manufacturer's files from', a directory with the file of the device driver will be displayed. Click [OK] button

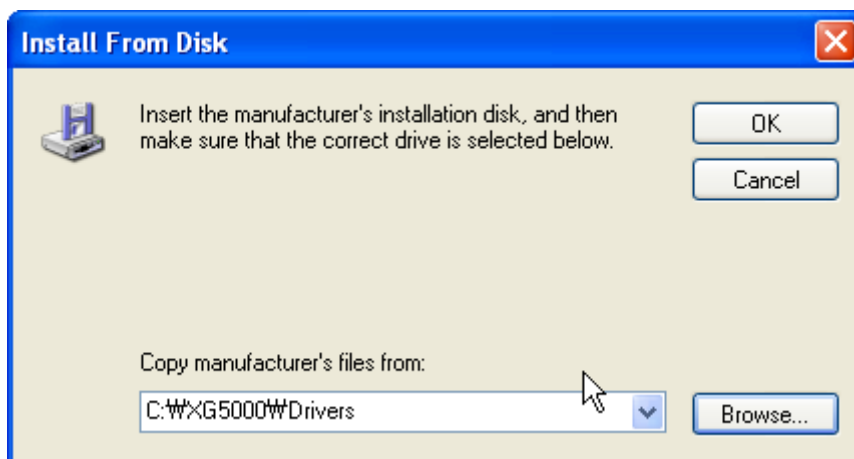

## Chapter 1 Introduction

- On 'Show compatible hardware' list of the device driver Select Dialog Box, select "LSIS XGSeries" driver and then click [Next] button

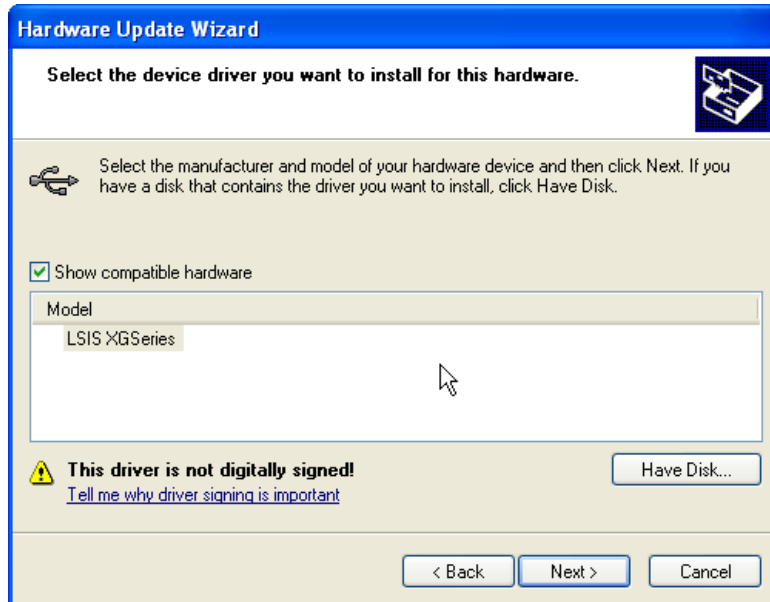

- Hardware Installation Dialog Box will appear. Click [Continue Anyway] to go on with the installation





9. Completing the Hardware Update Dialog Box will appear. Click [Finish] button to end the installation of the driver

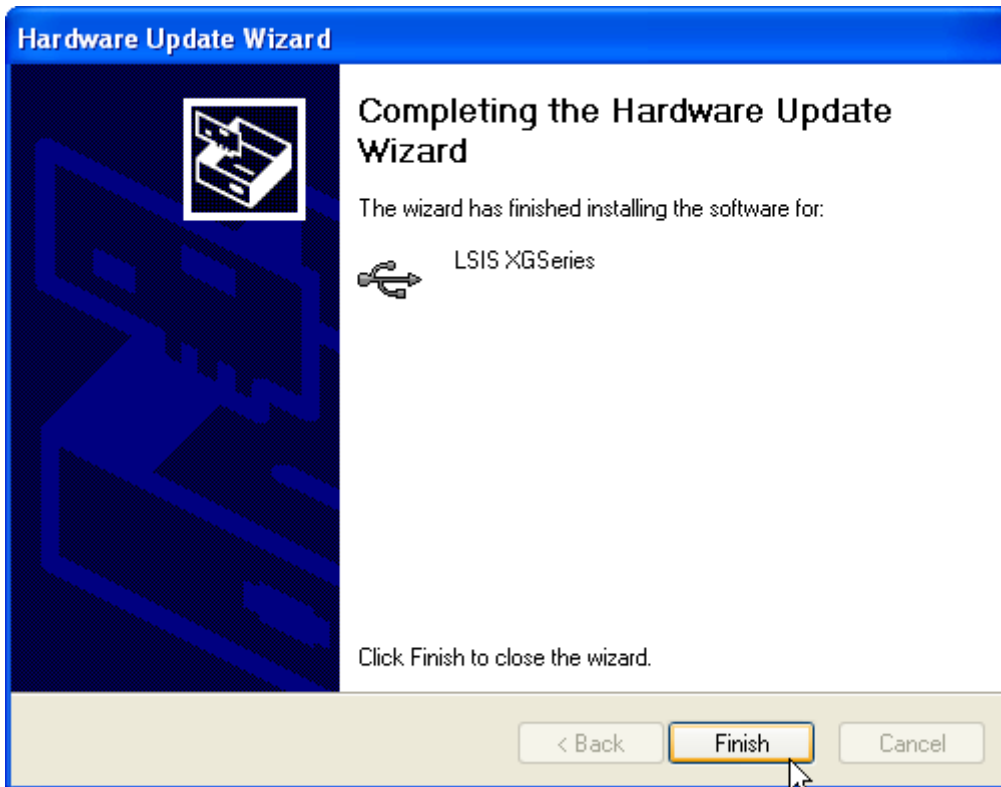

# Chapter 2 Basic Application

## 2.1 Screen Configuration

XG5000 screen is composed as shown below.

[Screen of XG5000]

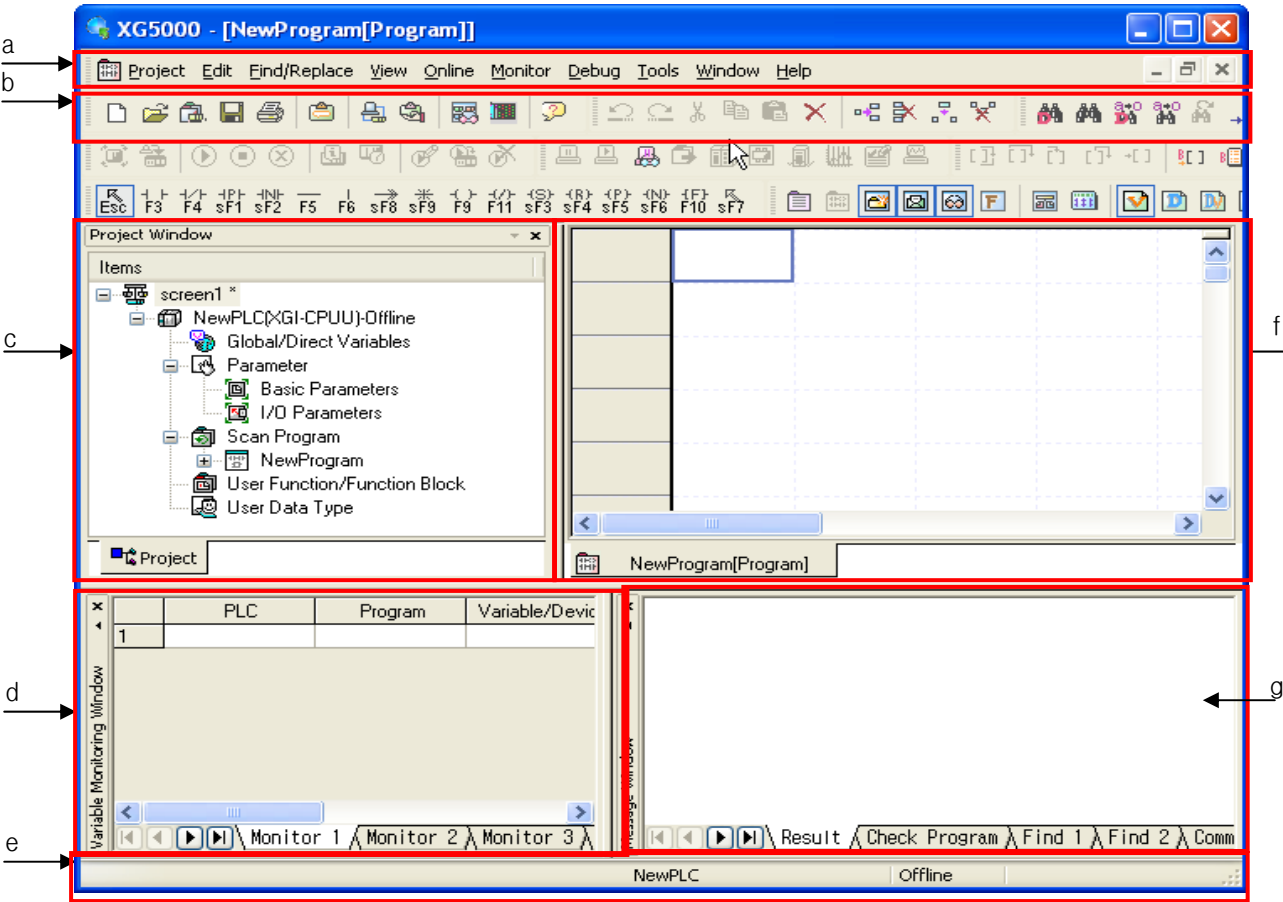

## Chapter 2 Basic Application

[Description of Dialog box]

- a. Menu bar: It is the basic menu bar for the XG5000 software.
- b. Tool bar: used to execute the instruction which contained in the menu conveniently
- c. Project window: used to display the components of the presently opened project
- d. Variable Monitoring window: used to register and monitor the variable.
- e. Status bar: used to display the status of XG5000, the information of connected PLC, etc..
- f. Edit window: The presently LD Edit window is displayed.
- g. Message window: Diverse message shows during using XG5000.

### 2.1.1 Menu Configuration

If the menu is selected, application instructions will be appeared and an instruction will be executed when an instruction is selected by clicking mouse button or pressing key. If the shortcut key for the menu (Ctrl + X, Ctrl + C) is available, press the shortcut key directly to select the instruction

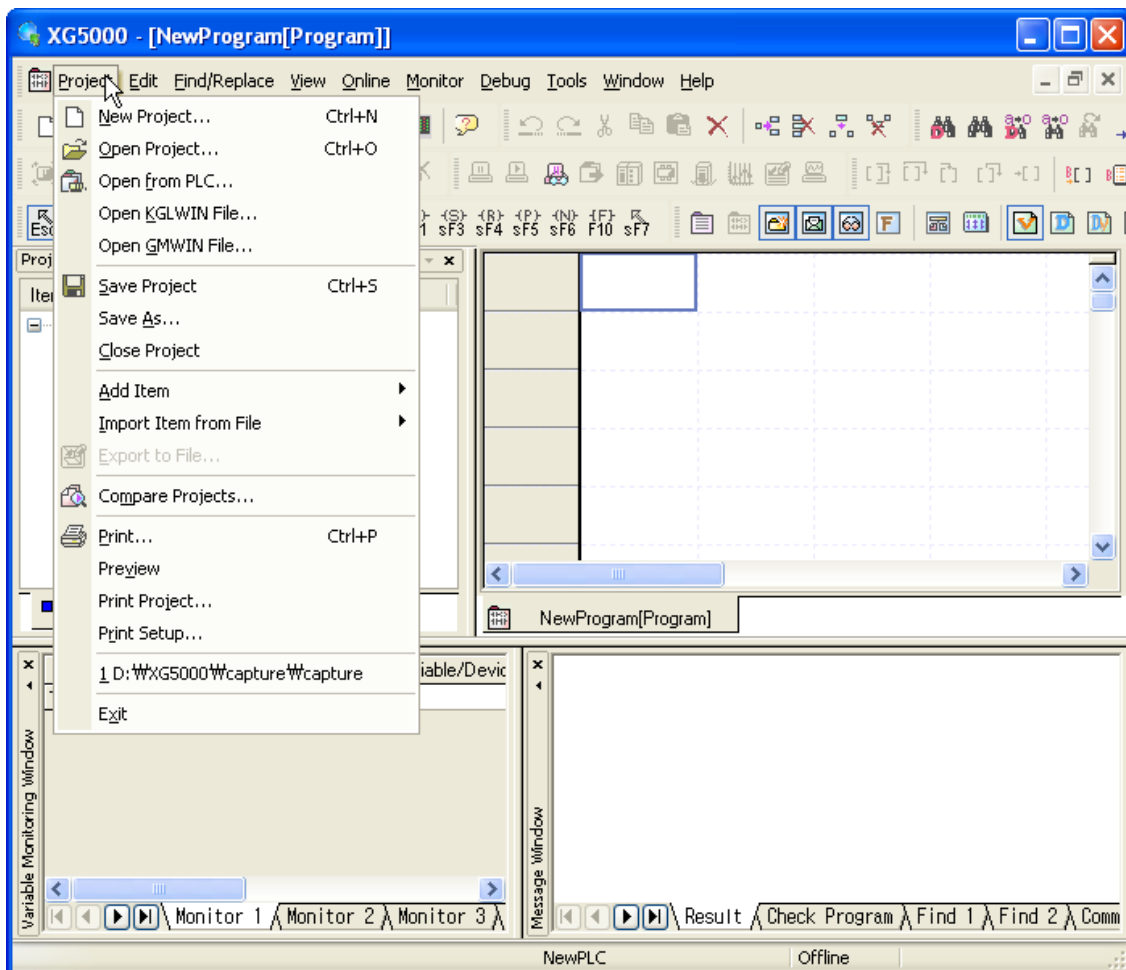

1) Project

Instruction		Description
New Project		Creates a new project.
Open Project		Opens the existing project.
Open from PLC		Uploads the project and program stored in PLC.
Open KGLWIN File		Opens the project file for KGLWIN.
Save Project		Saves the project.
Save As		Saves the project as a different name.
Close Project		Closes the project.
Add Item	PLC	Adds a new PLC to the project.
	Task	Adds a new task program to the project.
	Program	Adds a new scan program to the project.
	Function	Adds a new Function to the project.
	Function Block	Adds a new Function Block to the project.
	Data type	Adds a new Data type to the project.
Import from File	PLC	Imports the PLC program from the file.
	Global/Direct variable	Imports Global/Direct variable from the file.
	Program	Imports the program from the file.
	I/O parameter	Imports the I/O parameter from the file.
	Basic parameter	Imports the basic parameter from the file.
	Function/FB...	Imports the Function/FB from the file/
Export to File		Exports the selected item on the project window into the file.
Compare Projects		Compares two projects stored in PC and displays its result.
Print		Prints the active window's details.
Preview		Previously displays the screen to be printed.
Print Project		Selects the project item and print it.
Print Setup		Sets the printer options.
Exit		Ends XG5000.

2) Edit

Instruction	Description
Undo	Cancels the edit on Program Edit Window to recovers its previous status.
Redo	Recovers the edit cancelled above.
Cut	Copies the selects block to clipboard and deletes the block.
Copy	Copies the selects block to the clipboard.

## Chapter 2 Basic Application

Instruction		Description
Paste		Copies from the clipboard onto Edit Window.
Delete		Deletes the selected block or items.
Select All		Selects all block of presently active window.
Insert mode		Converts overwrite mode to insert mode
Overwrite mode		Converts insert mode to overwrite mode.
Insert Line		Adds a new line to the cursor position.
Delete Line		Deletes the line from the cursor position
Insert Cell		Adds a cell to the cursor position.
Delete Cell		Deletes a cell from the cursor position
Optimize Program		Optimizes the program automatically.
Insert Comment/Label		Inputs a comment or label in the cursor position.
Set Block Mask		Sets cursor-positioned rung or specified block area as non-execution expression in the rung unit
Remove Block Mask		Cancels non-execution expression of cursor-positioned rung or specified block area.
Bookmark	Set/Remove	Sets or cancels a bookmark.
	Remove All	Cancels all the bookmarks specified.
	Previous Bookmark	Moves to the previous bookmark.
Bookmark	Next Bookmark	Moves to the next bookmark.
Edit Tools		Edit Tools for each program are available.

### 3) Find/Replace

Instruction		Description
Find Device		Finds the desired device based on the type.
Find String		Finds the desired String.
Replace Device		Finds the desired device to replace with a new device.
Replace String		Finds the desired String to replace with a new String.
Find Again		Repeats Find or Replace previously executed.
Go To	Step/Line	Moves the cursor to the position of a desired step/line.
	Rung comment	Moves the cursor to the position of a desired rung comment.
	Label	Moves the cursor to the position of a desired label.
	End Instruction	Moves the cursor to the position of END Instruction.
Previous Message		Moves from the message window to the place the previous message

Instruction	Description
	indicates.
Next Message	Moves from the message window to the place the next message indicates.

#### 4) View

Instruction	Description
IL	Converts to IL View during LD Edit.
LD	Converts to LD View during IL Edit.
Project Window	Shows or hides the project window.
Message Window	Shows or hides the message window.
Variable Monitoring Window	Shows or hides the variable monitor window.
Instruction Window	Shows or hides the instruction window.
Cross Reference	Displays the used-memory information on the message window's Cross Reference tap.
Used Device	Displays the used-device information on the message window's used-device tap.
Check Program	Inspects the program and displays its result on the message window's Check Program tap.
Variables	Displays the variable name in the program.
Devices	Displays the device name in the program.
Devices/Variables View	Displays the device and the variable in the program.
Devices/Comments View	Displays the device and the comment in the program.
Zoom-In	Displays the screen magnified.
Zoom-Out	Displays the screen reduced.
Full screen	Magnify program or variable/comment window to full screen.
Resize Width	Automatically adjusts the cell width applicably to the string width in the Variable/Comment window.
Resize Height	Automatically adjusts the cell height applicably to the string height in the LD or Variable/Comment window.
Full Screen	Enlarge the program window or Variable/Comment window applicably to the whole screen.
Properties	Displays the registered information of the selected item on the project window.
LD Properties	Sets the LD screen's properties.
Change Columns	Changes columns of LD screen.

## Chapter 2 Basic Application

Instruction	Description
Open Local Variable	Converts from the program screen to the local variable screen.
Open Program	Converts from the local variable screen to the program screen.
Open User Function/Open Function Block	If selects the user function/FB and select the 'Open User Function', converts to User Function/FB Program screen

### 5) Online

Instruction	Description
Connect/Disconnect	Connects or disconnects with PLC.
Connect Settings	Specifies the connection method.
Change Mode	Run
	Stop
	Debug
	Changes PLC mode.
Read	Reads parameter/program/comment from PLC.
Write	Writes parameter/program/comment on PLC.
Compare with PLC	Compares the project to the project saved in PLC
Reset PLC	Resets PLC.
Clear PLC	Deletes parameter/program/comment saved in PLC.
PLC Information	Displays PLC information.
PLC History	Displays PLC history.
PLC Errors/Warnings	Displays PLC error/warning information.
I/O Information	PLC I/O Sync. And displays information
Save PLC History	Saves PLC History
Force I/O	Displays the window for compulsory I/O setting.
I/O Skip	Displays the window for I/O skip setting.
Fault Mask	Displays the window for fault mask setting.
Module Changing Wizard	Displays the dialog window to change modules.
Start Online Editing	Starts modification during run.
Write Modified Program	Writes the program and information modified during run on PLC
End Online Editing	Ends modification during run.

6) Monitor

Instruction	Description
Start/Stop Monitoring	Starts or stops the monitor.
Pause	Temporarily stops the monitor.
Resume	Restarts the monitor temporarily stopped.
Pausing Conditions	Specifies conditions for the monitor temporary stop.
Change Current Value	Specifies the device value being monitored.
System Monitoring	Executes the system monitor.
Device Monitoring	Executes the device monitor.
Special Module Monitoring	Executes the special module monitor.
Trend Monitoring	Executes the trend monitor.
Custom Events	Specifies the custom events.
Data Traces	Specifies the device to monitor the change of the data.

7) Debug

Instruction	Description
Start/Stop Debugging	Converts to Debug mode to Start/Stop Debugging.
Go	Runs to the break point.
Step Over	Runs step by step.
Step Into	Debugs the subroutine.
Step Out	Escapes from the subroutine.
Go to Cursor	Runs to the cursor position.
Set/Remove Breakpoints	Sets or cancels the break point.
Breakpoints List	Displays the list of the break points specified.
Breakpoint Conditions	Specifies the break conditions

8) Tools

Instruction	Description
Network Manager	Shows the PLC network and specifies the parameter.
Start/End Simulator	Starts or ends the simulator.
Customize	User defines tools and instructions.
Shortcut Settings	User specifies the Shortcut Keys.
Options	Changeable applicably to XG5000 environment by user.



## Chapter 2 Basic Application

### 9) Window

Instruction	Description
New Window	Opens a new window on the active window.
Split	Divides the active window.
Cascade	Arranges the several windows of XG5000 in steps.
Tile Horizontally	Arranges the several windows of XG5000 horizontally
Tile Vertically	Arranges the several windows of XG5000 vertically
Arrange Icons	Arranges the icons of XG5000.
Close All	Closes all the windows of XG5000.

### 10) Help

Instruction	Description
XG5000 Help	Opens Help for XG5000 application.
XGK/XGB Instruction Help	Opens Help for XGK/XGB PLC instructions.
XGI Instruction Help	Opens Help for XGI instructions.
LSIS Web Site	Connects to LSIS Home Page via the Internet.
About XG5000	Displays XG5000 information.

## 2.1.2 Tool Box

XG5000 provides the shortcut icons for frequently used menus. Click a tool desired to execute.

[Tool Box]

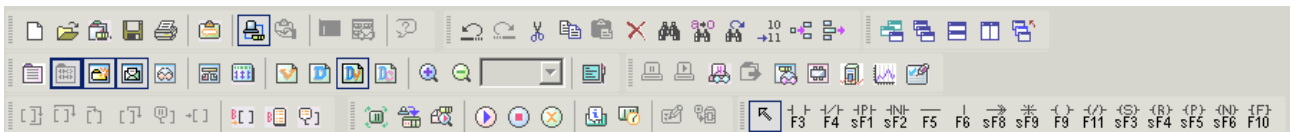

### 1) New Tool Box

It is used to create a new tool box containing frequently used tools.

[Steps]

1. Select [Tools]-[Customize] on the menu
2. Click [New] button.
3. Input the tool name on the dialog box of new tool box.
4. Click [OK] to create a tool box with no tools.

[Dialog Box]

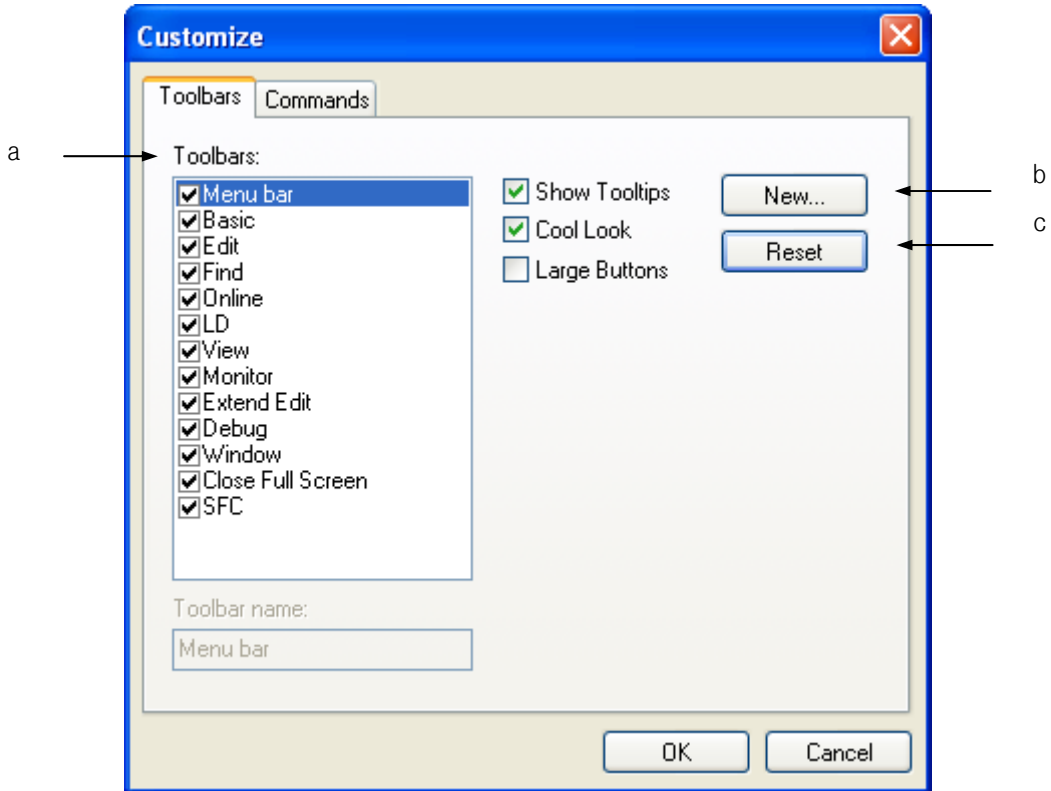

[Description of Dialog Box]

- a. Tool Bar: used to show or hide the Tool Box by checking the check box in front of each tool box name on the list.
- b. New: used to create a new tool box.
- c. Reset: initializes the tool box.

## 2) Tool Box Fill

It is used to fill the Tool Box created as above with tools..

[Steps]

1. Select the instruction tap on the customized dialog box.
2. After the tool box is created, click [OK].

## Chapter 2 Basic Application

[Dialog Box]

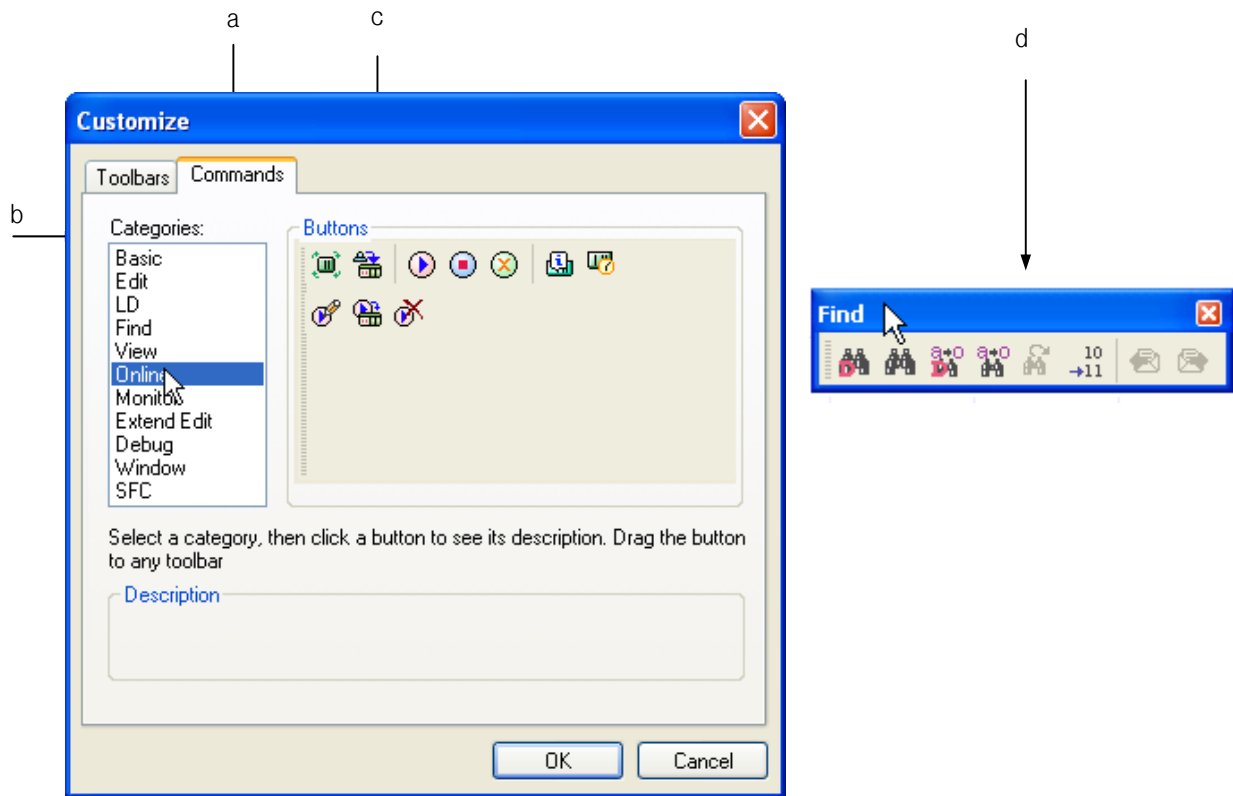

[Description of Dialog Box]

- Instruction: It is an instruction tap of the customized Dialog Box.
- Categories: used to select the existing tool box.
- Buttons: used to select a tool desired.
- User's Tool Box: From the c. Button, drag a desired tool and drop it on the user's tool box to add the tool.

### 2.1.3 Status Display Line

[Dialog Box]

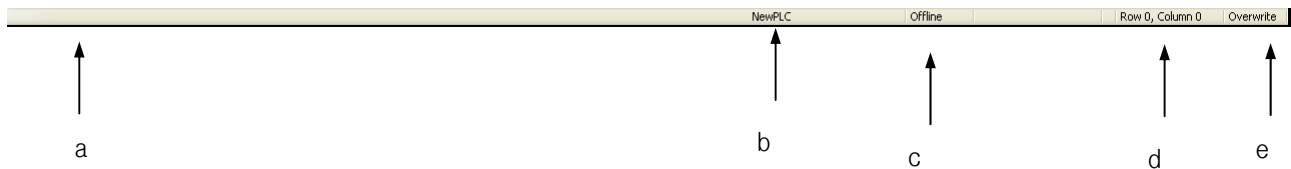

[Description of Dialog Box]

- a. Comment of Instruction: used to display the comment of the selected menu, instruction or mouse-positioned tool box
- b. PLC name: used to display the selected PLC name. If several PLCs are in a project, online-related instructions will be applied to the PLC displayed here
- c. PLC Mode display: used to display the PLC mode. If several PLCs are in a project, the selected PLC mode will be displayed
- d. Warning Display: used to display the error status in PLC
- e. Cursor Position Display: used to display the cursor position when a program is edited
- f. Mode display: used to display the insert mode or overwrite mode.

### 2.1.4 Change View Window

All the windows (such as project window, result window, etc.) available in View menu are composed of docking-available windows. Use the mouse to adjust the position and the size of the windows or to hide the windows

## Chapter 2 Basic Application

- 1) Move Position with the left mouse button pressed, drag the mark “↖” to a desired position. The figure below shows the project window moved downward.

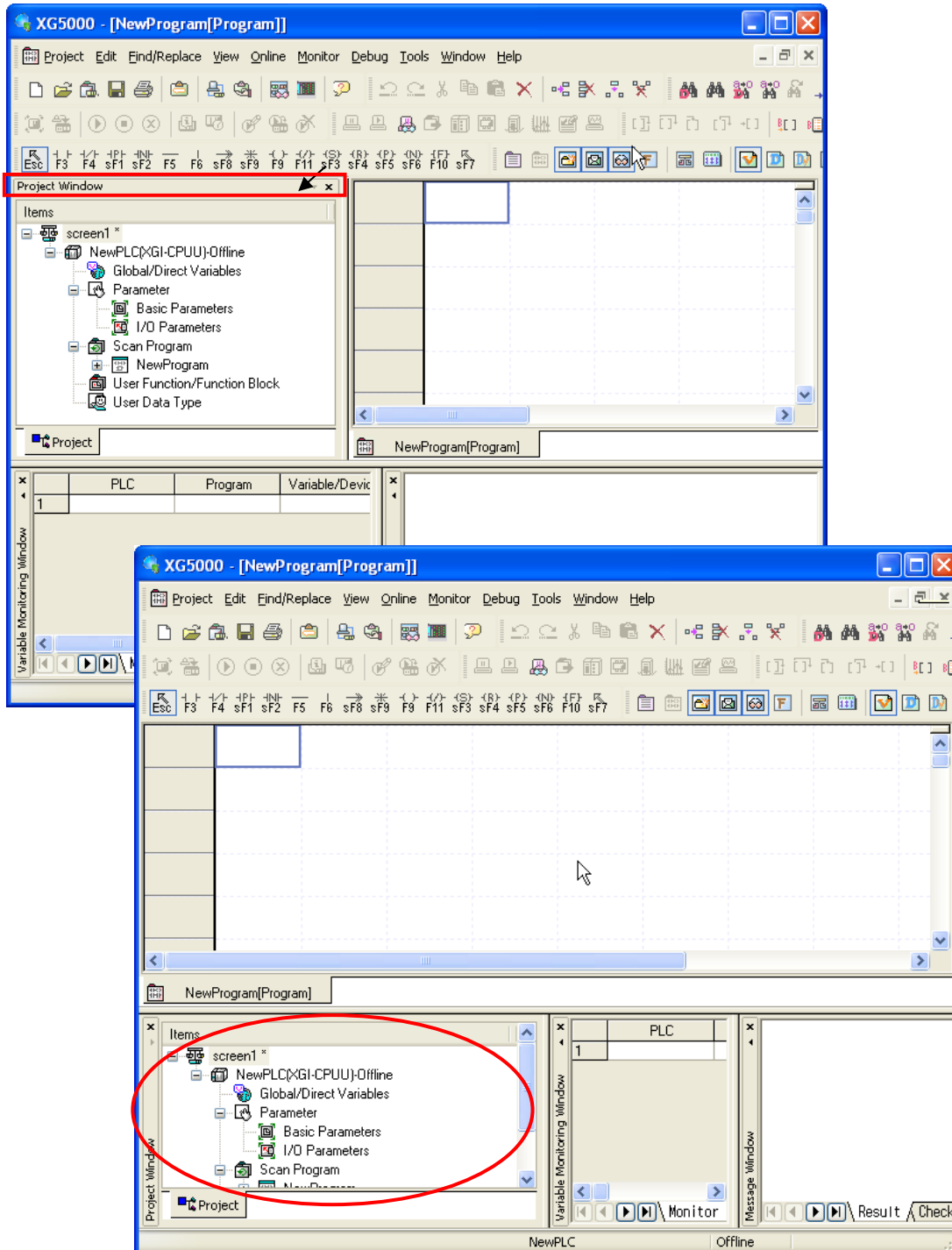

### 2) Change to Open Window

Click the right mouse button positioned on the desired window and select [Float in Main Window] on the menu.

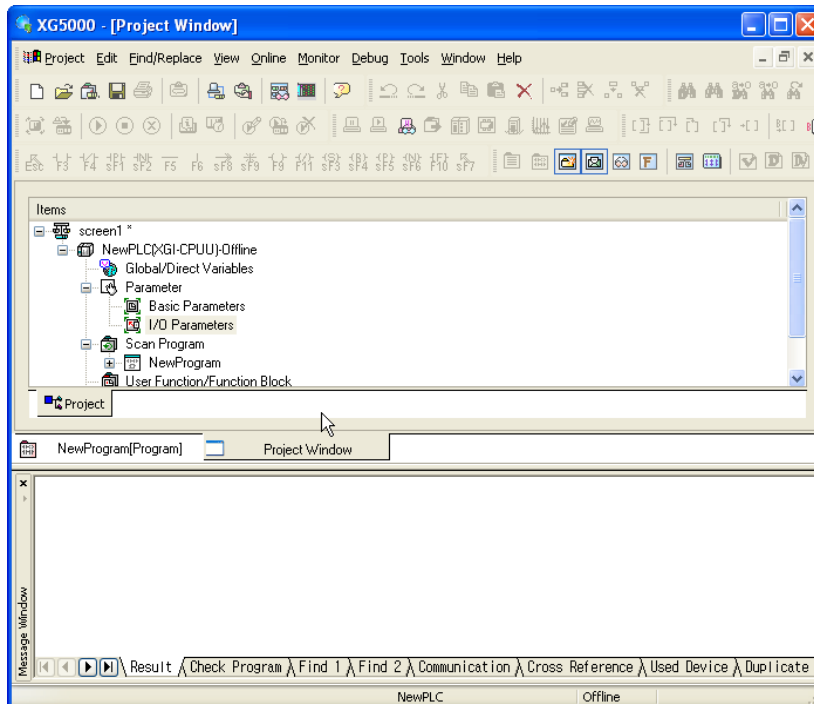
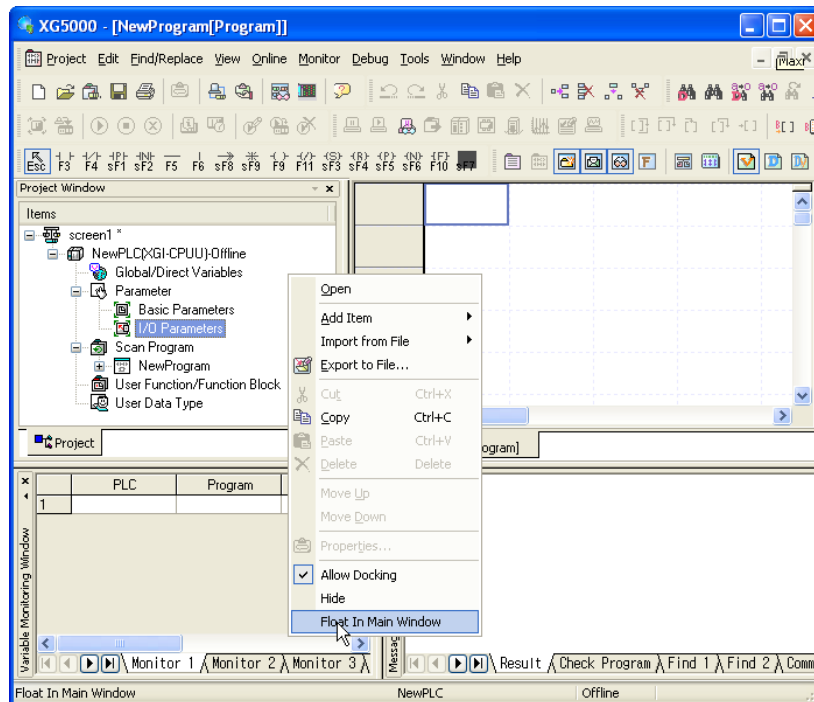

### 3) Hide

Click the right mouse button positioned on the desired window and select [Hide] on the menu.

### 2.1.5 Application of Dialog Box

Dialog Box provides blanks for Input, OK, Options and List Box where the user can input or specify the value as desired.

[Dialog Box]

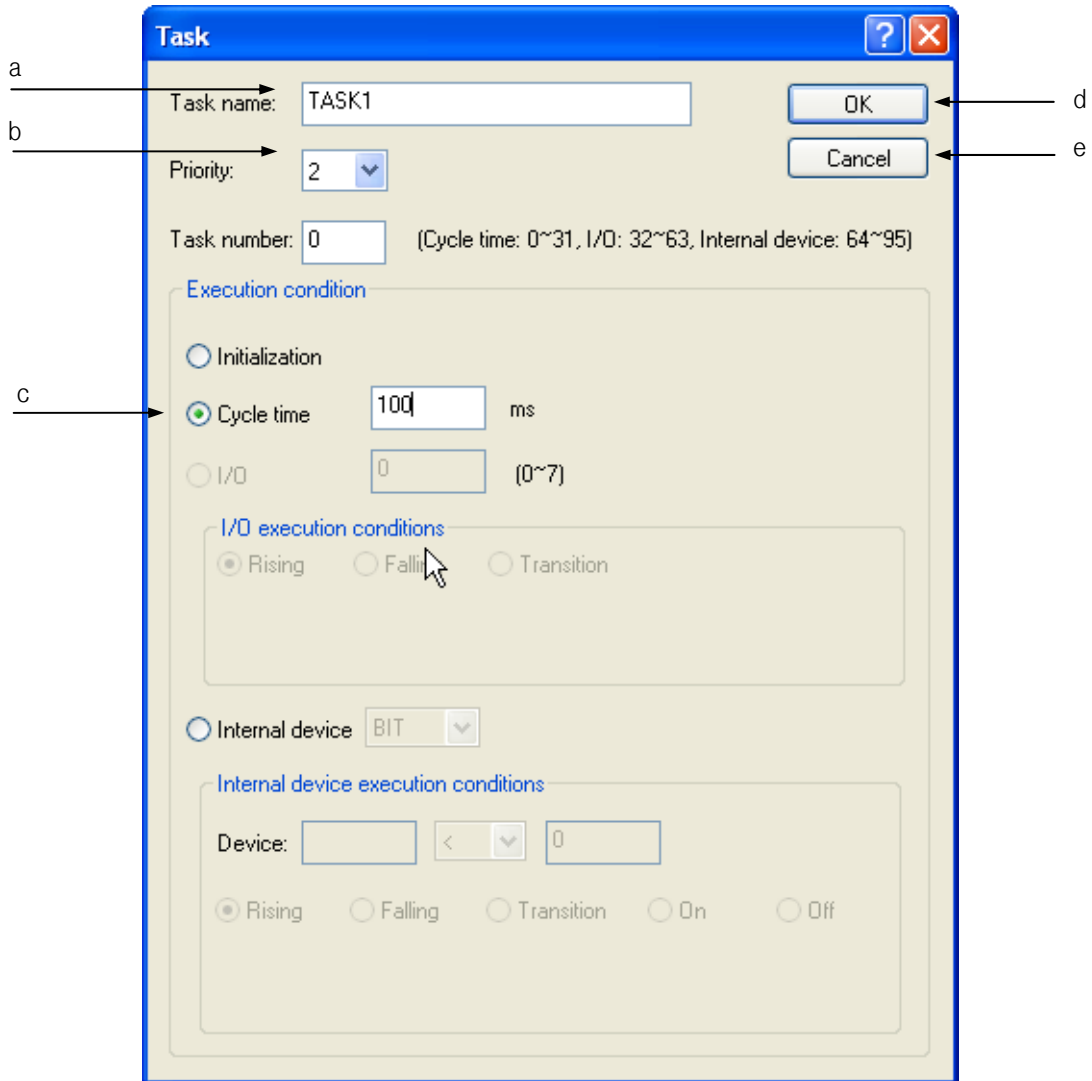

[Description of Dialog Box]

- a. Input: used to input desired string by means of keys.
- b. List Box: used to select an item on the list. Press the list box arrow to display the list with the item to click and select as desired
- c. Options: used to select just one item in the same group. Use the mouse to select the item desired
- d. OK: If [OK] is clicked, the specified value will be input
- e. Cancel: If [Cancel] is clicked, the specified value will not be input but the previous status will be kept



### 2.2 Open/Close Project

#### 2.2.1 Open Project

[Steps]

1. Select [Project]-[Open Project] on the menu
2. Select [Project File] and then click [Open]

#### Note

- The extension of XG5000 project file is “.xgp”. On the Open Dialog Box, select Project File to check the project comment in the comment area

#### 2.2.2 Close Project

[Steps]

1. Select [Project]-[Close Project] on the menu. Default of the Shortcut Key is not specified
2. If the project is not saved after edited, the following message will appear.

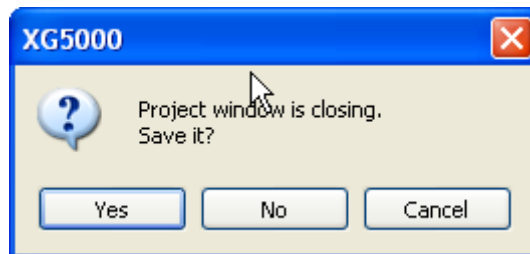

3. Click [Yes] to save.

#### 2.2.3 Save Project

[Steps]

1. Select [Project]-[Save Project] on the menu.

#### Note

- The mark "\*" displayed to the right of the project name on the project window means that the present project has been edited

## 2.3 Convenient Edit Functions

These functions are available in LD, IL, Variable/Comment, Variable Monitor and Project Window. Variable/Comment and Excel can share the edited details with each other

### 2.3.1 Cut-Paste

It is used to select blocks to move to other places

[Steps]

1. [Cut]-[Paste] menu is used to move the data of the selected area to a new position to paste the data on.

The example of [Cut]-[Paste] on the Variable/Comment Window is as follows

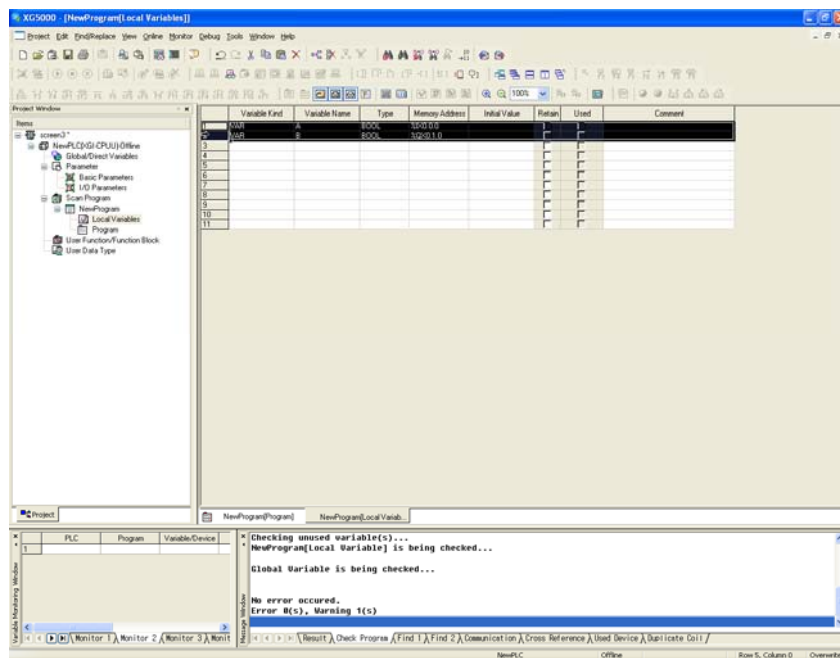

## Chapter 2 Basic Application

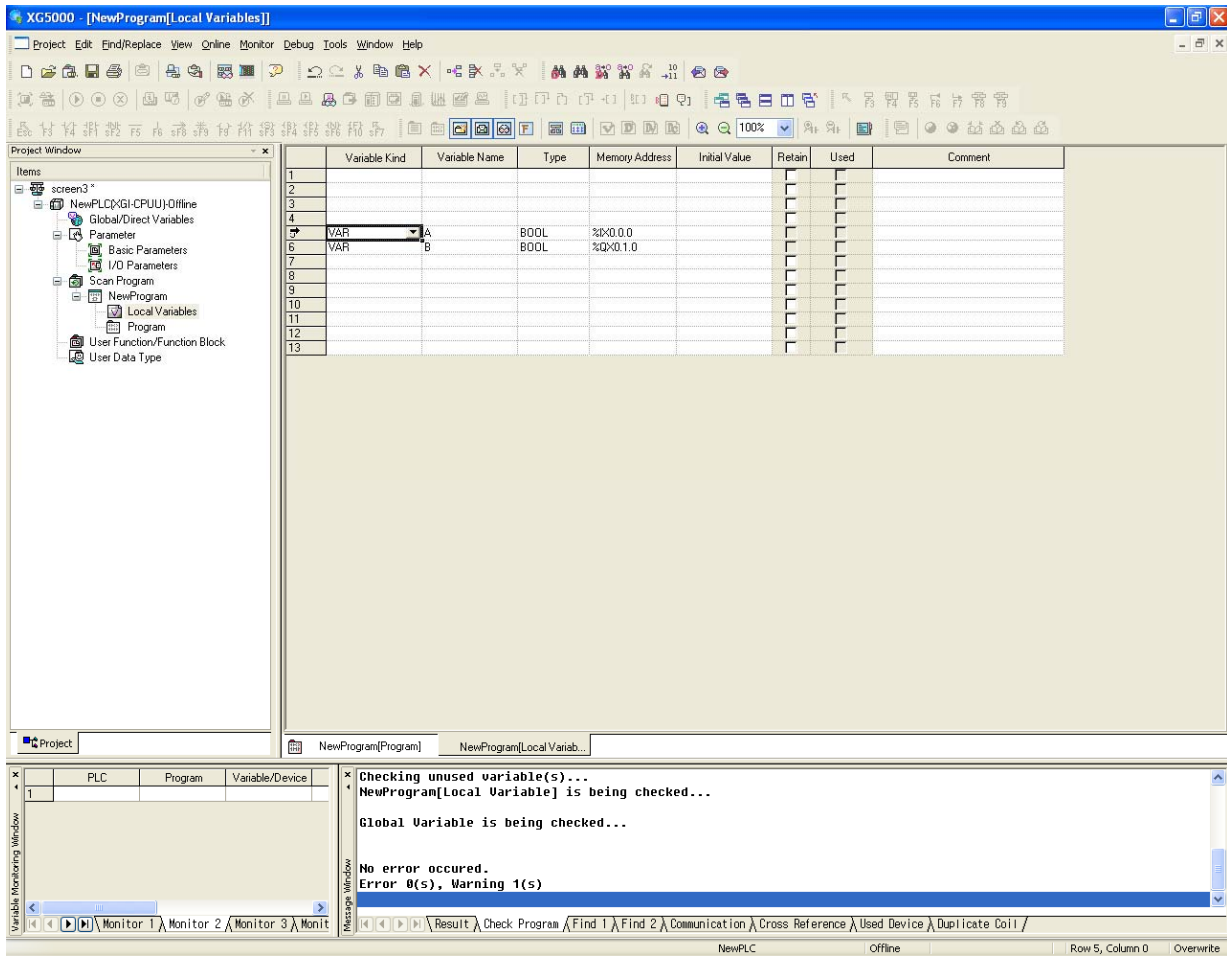

### 2.3.2 Copy - Paste

[Copy] - [Paste] menu is used to create one more data identical to the data of the selected area. At this time, in case that the variable name should not be duplicate as described in Variable/Comment, an applicable warning message will appear. Refer to the comment of each edit window for more details. The example of [Copy] - [Paste] in LD figure is as follows

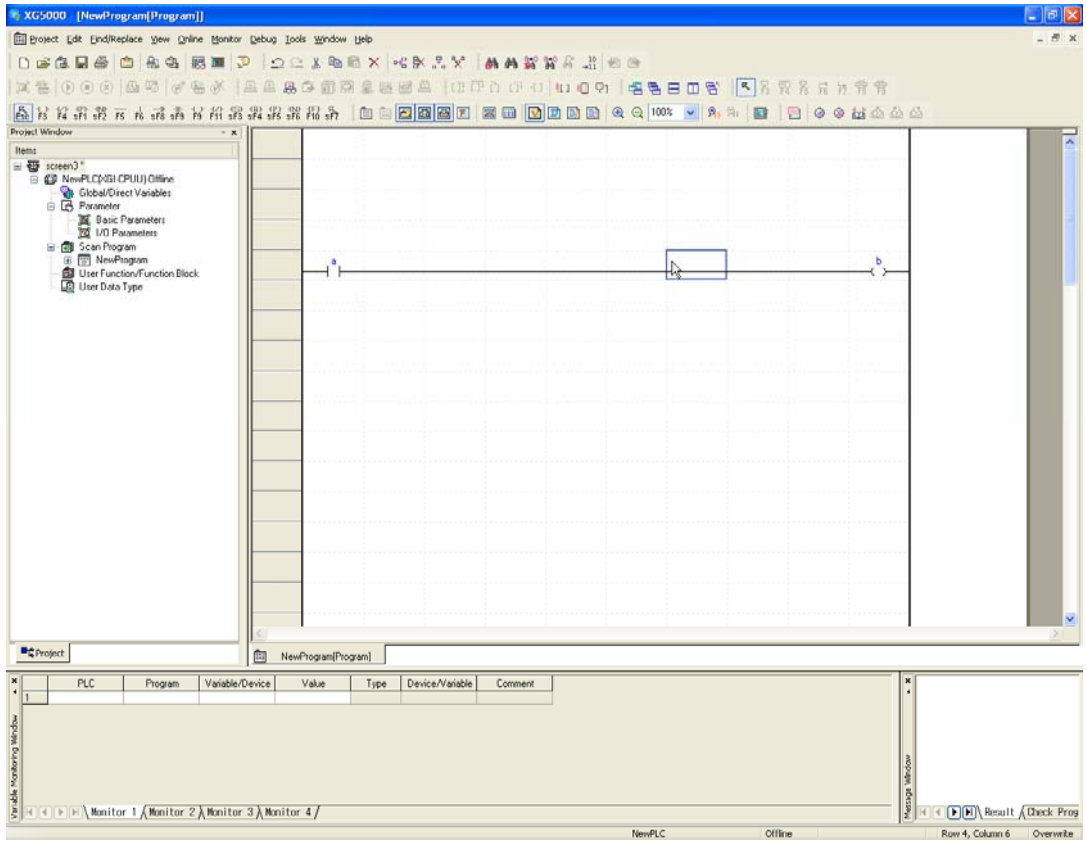
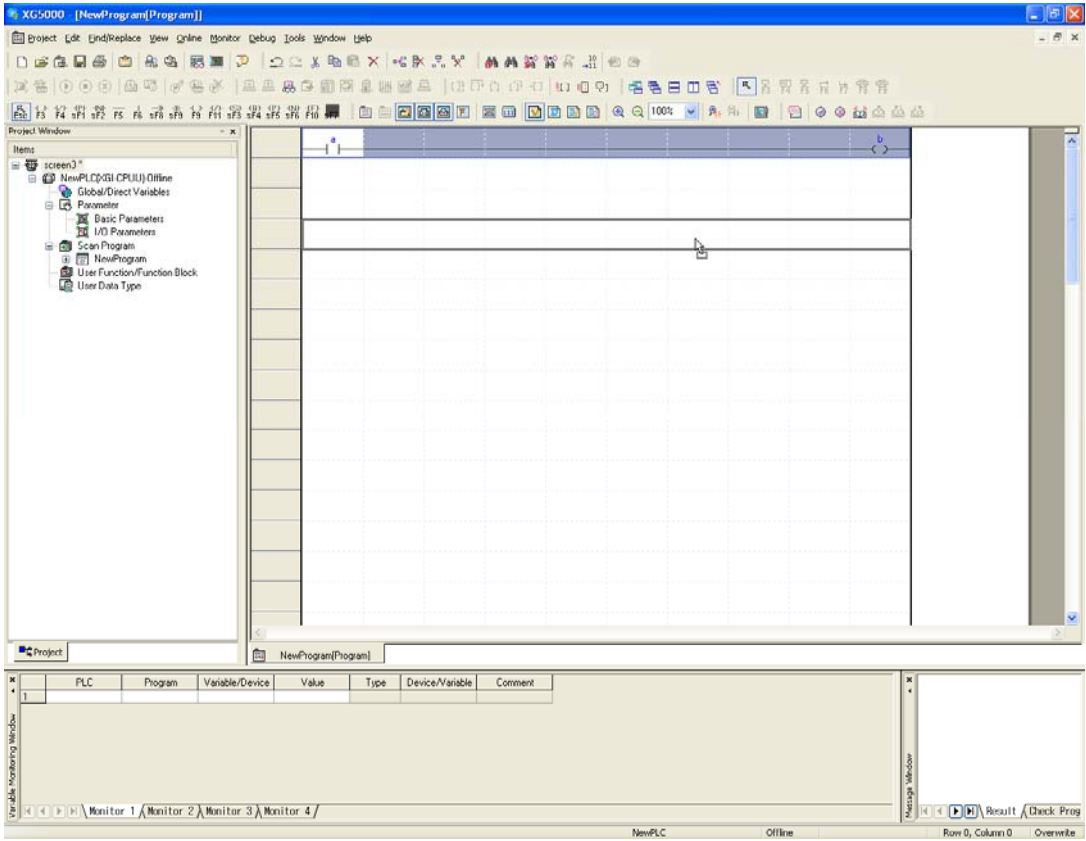

## Chapter 2 Basic Application

### 2.3.3 Drag & Drop

Drag & Drop is to apply either [Cut] – [Paste] or [Copy]- [Paste] under conditions.

When dragging and dropping in a same area such as same LD or IL window, it applies [Cut]-[Paste]; if dragging and dropping with two and more XG5000 Program instances opened, it applies [Copy]-[Paste].

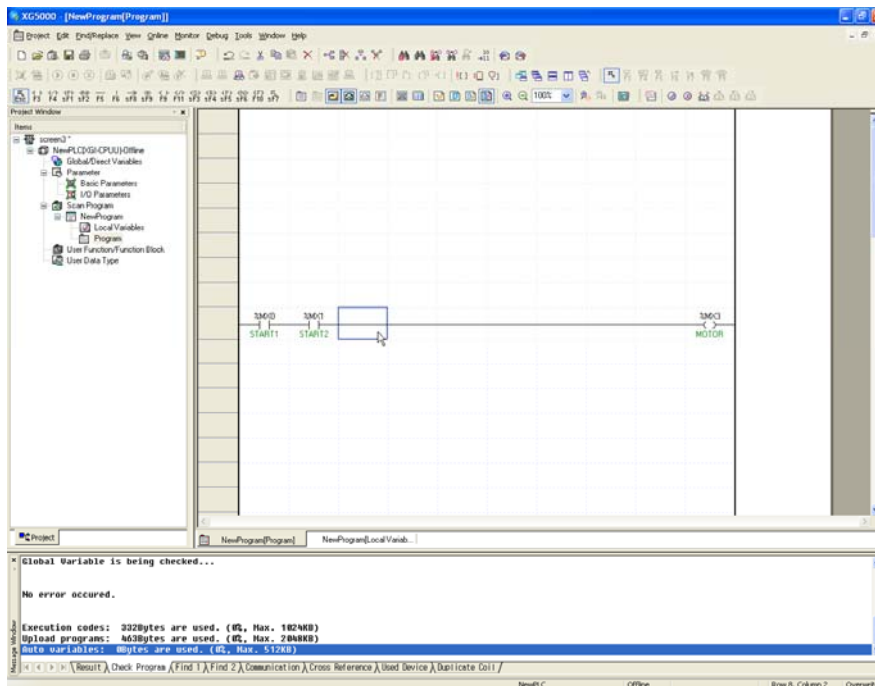
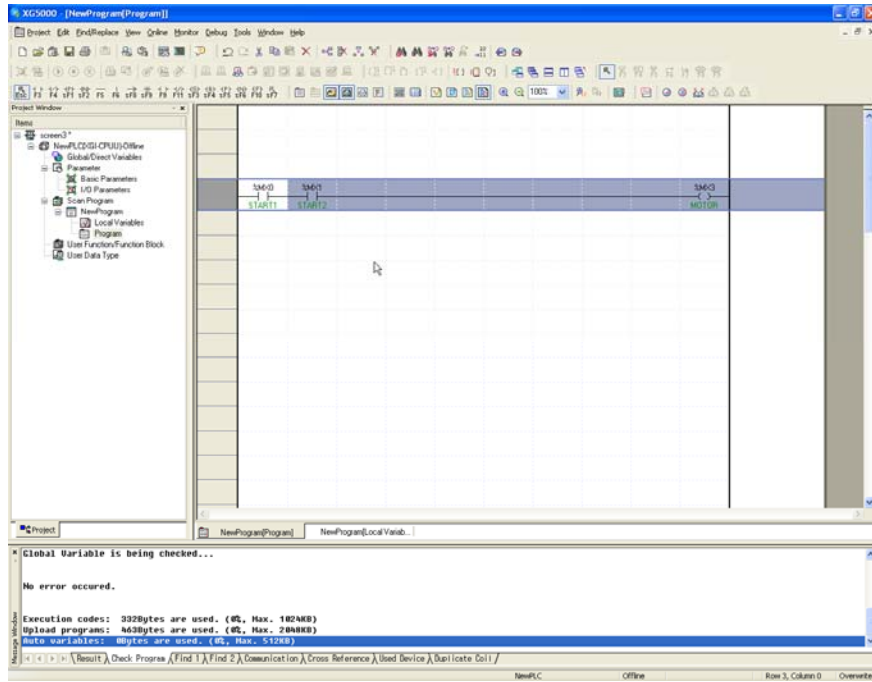

The above figure shows the results of Drag & Drop when selecting a line in an instance.

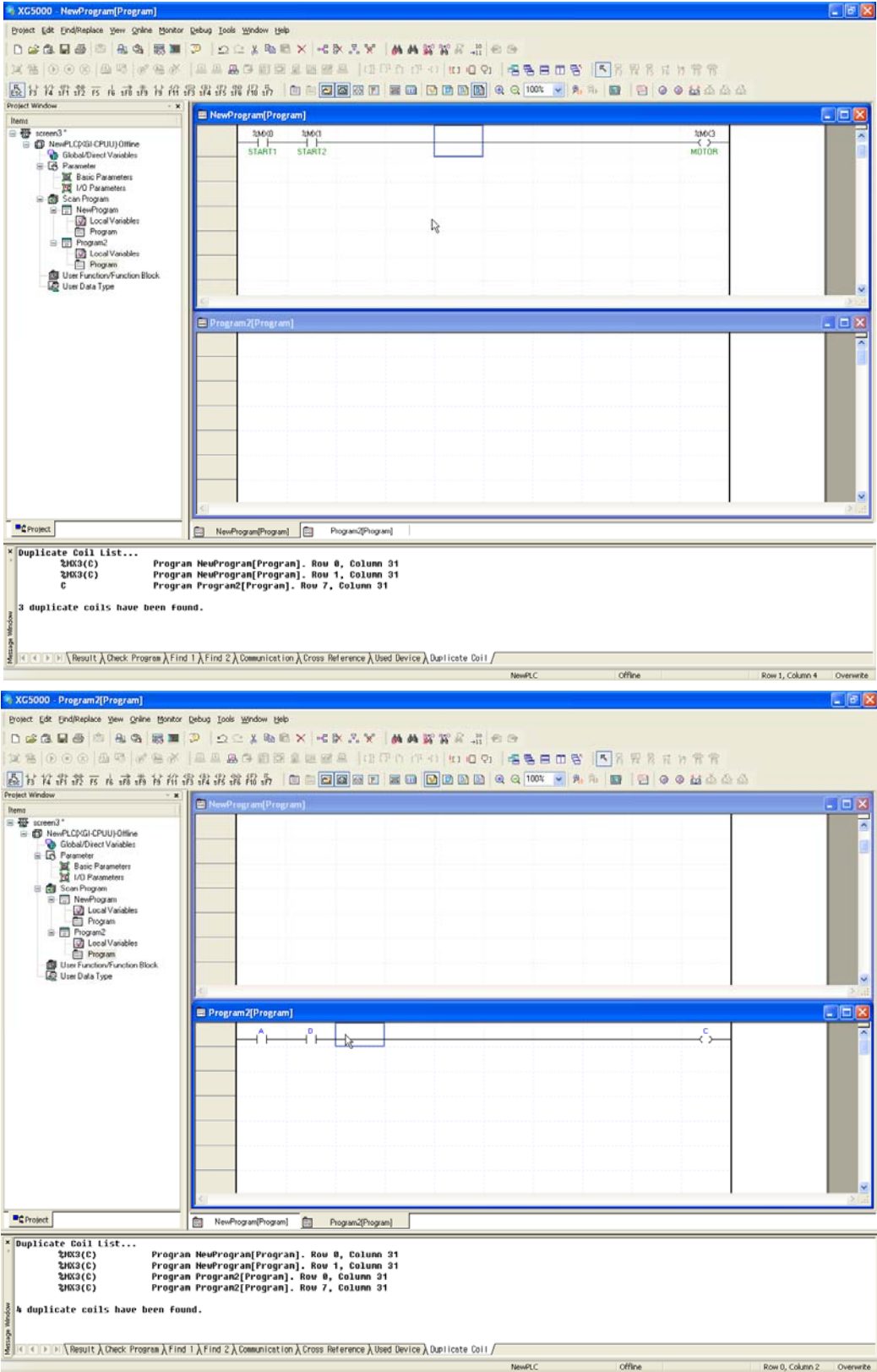

The above figure shows the results when dragging and dropping a selected area in two instances.

### Notes

- Cut, Copy and Paste can be also controlled by the mouse context menu in Edit window.
- Copy/Paste in Variable/Comment or LD/IL Edit is verified for the duplication by the program. However, it should be also checked manually by a user.
- Program does not respond if Cut, Copy or Paste is operated in an unavailable area.
- Cut, Copy or Paste from/to different areas may cause fatal program errors.
- Auto conversion function is not provided when Cut, Copy or Paste is attempted from/to different areas.  
Therefore, a user should check the pasted area.

## 2.4 Shortcut Setting

Shortcut Keys can be specified for all the instructions. At this moment, the Shortcut Keys already specified will be deleted.

[Steps]

1. Select [Tools]-[Shortcut Settings] on the menu.

[Dialog Box]

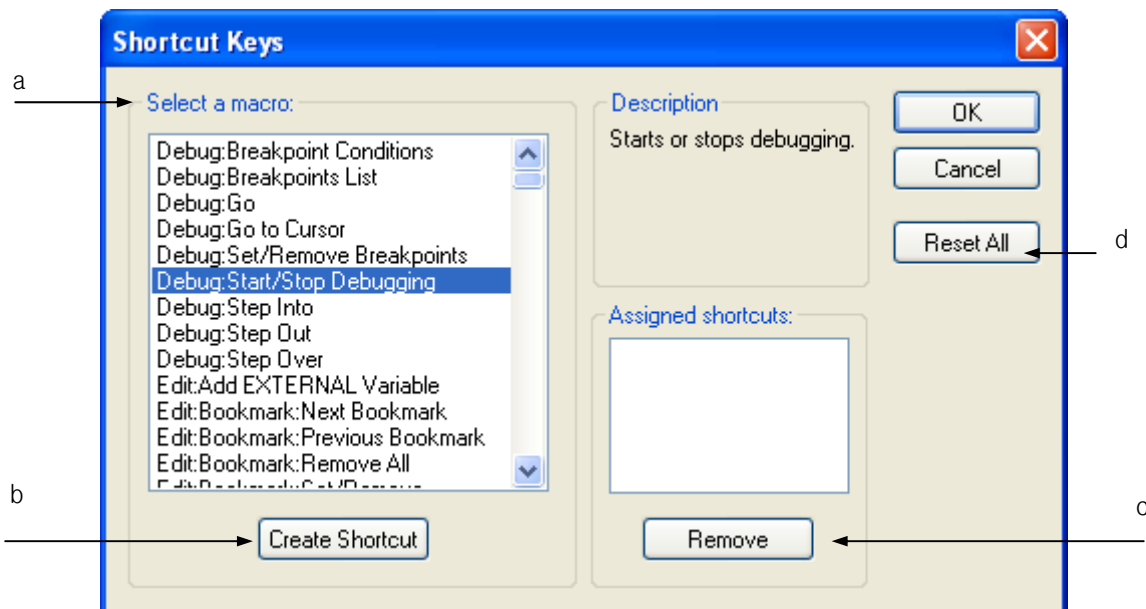

[Description of Dialog Box]

Select a macro: used to select the menu to specify its shortcut key on the list.

Create Shortcut: used to create a shortcut key for the selected menu.

Remove: deletes the specified shortcut key.

Reset All: deletes all the shortcut keys specified and resets all to default.

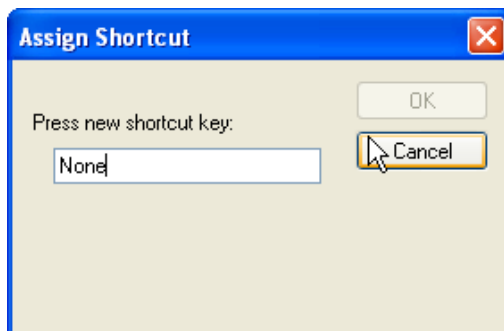



## Chapter 2 Basic Application

---

2. Select the menu to specify its shortcut key on the Menu Select list.
3. Click [Create Shortcut] button.
4. Click the shortcut key to set. For example, if Shift + F8 is desired to apply, press F8 together with Shift being pressed on the keyboard. Then a shortcut key will be displayed on the Edit Window. If this key association is already used, a menu applicable to the specified shortcut key will be displayed.
5. Click [OK].

## 2.5 Edit Window Zoom In, Zoom Out

This function is used to magnify or reduce the Edit Window in a specific rate.

The applicable magnification rate changes by minimum 5% within the range of 50% ~ 200%.

[Steps]

1.1. Select [View]-[Zoom In] or [View]-[Zoom Out] on the menu as necessary. Or use the combo box to select or input a desired magnification rate. Or together with Ctrl being pressed, use the mouse wheel to adjust the rate. The two figures below show the examples of 50% and 200% magnified screens.

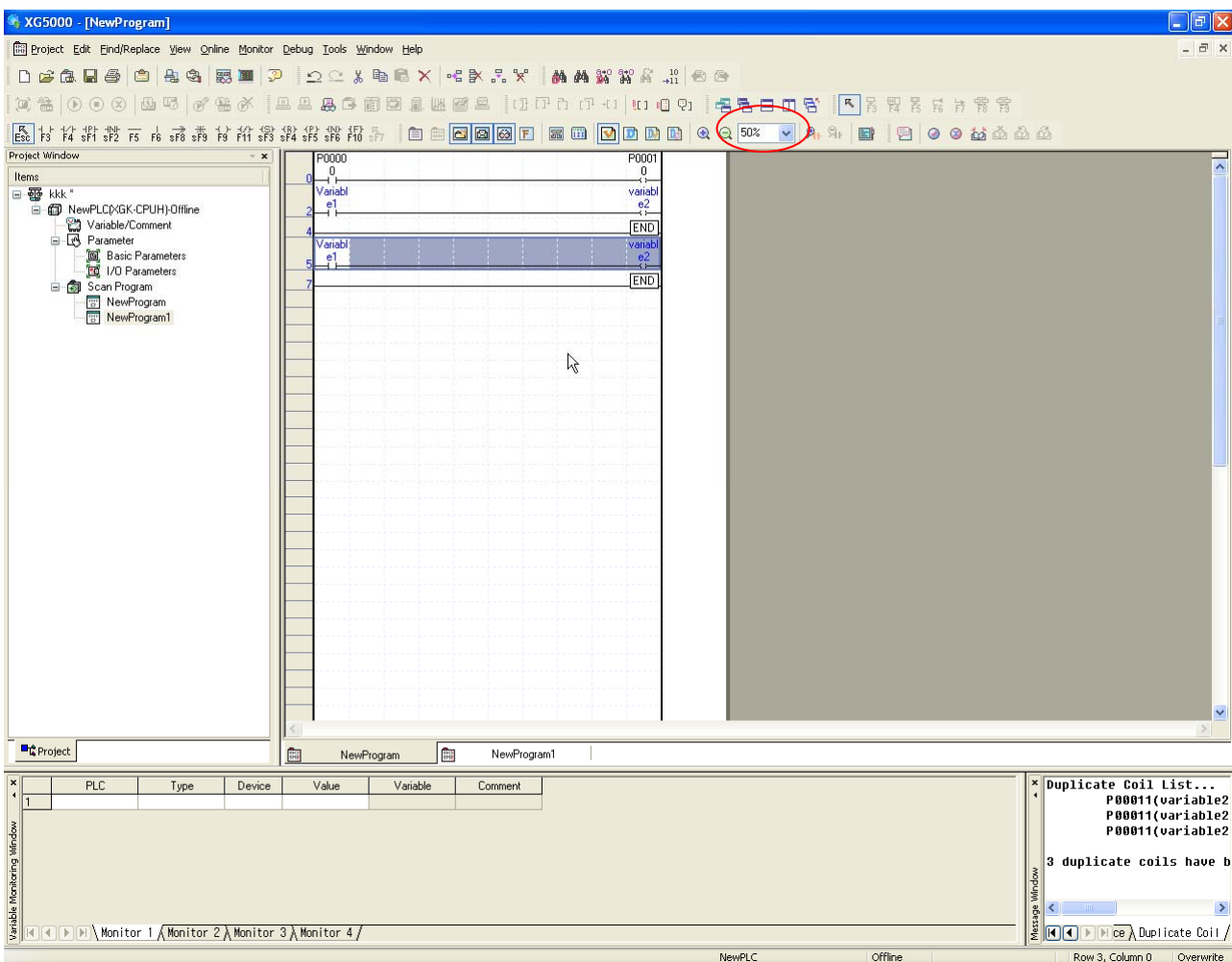

## Chapter 2 Basic Application

The screenshot displays the XG5000 software interface for a new program. The main editing area shows a ladder logic network with a coil labeled 'Variable1' at address 5, which is highlighted in blue. The network also includes a coil labeled 'P00000' at address 0. The Project Window on the left shows a tree structure with 'NewProgram1' selected. The Variable Monitoring Window at the bottom shows a table with columns for PLC, Type, Device, Value, Variable, and Comment. The Message Window on the right displays a warning: 'Duplicate Coil List... P00011(variable2) P00011(variable2) P00011(variable2) 3 duplicate coils have b'. The status bar at the bottom indicates 'NewPLC Offline' and 'Row 3, Column 0 Overwrite'.

PLC	Type	Device	Value	Variable	Comment
1					

Duplicate Coil List...  
P00011(variable2)  
P00011(variable2)  
P00011(variable2)  
3 duplicate coils have b

Variable Monitoring Window  
NewPLC Offline  
Row 3, Column 0 Overwrite

## 2.6 Options

### 2.6.1 Option configuration

Option of XG5000 is as follows..

[Dialog Box]

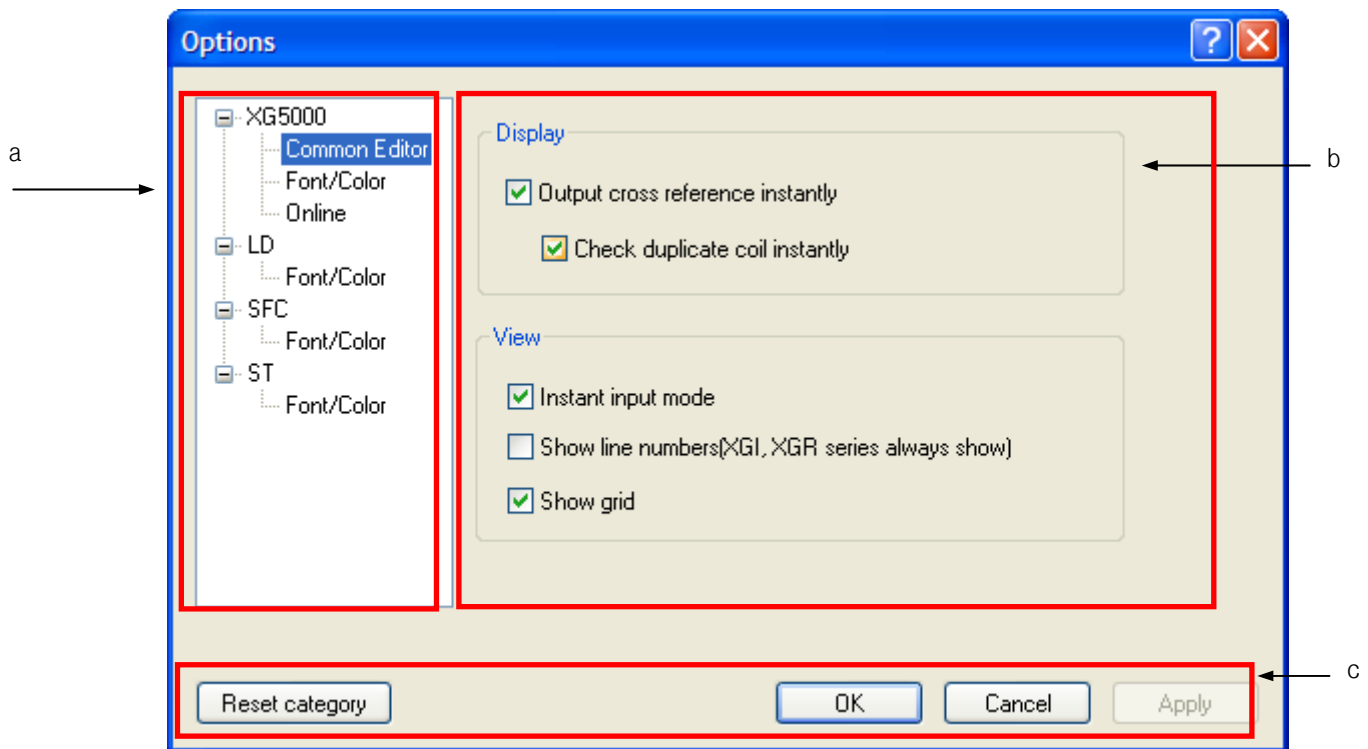

[Description of Dialog Box]

- a. Category: XG5000 options applied to entire program and operations applied according to language are classified as tree type
- b. Setting contents: If you select category, applicable contents are displayed
- c. Common button: Common button applied to all categories no matter which category is selected  
Reset category button is used to reset all options.

### 2.6.2 XG5000 option

Specify items related with project.

[Steps]

Select [Tools]-[Options]

Select XG5000 in option dialog box

[Dialog box]

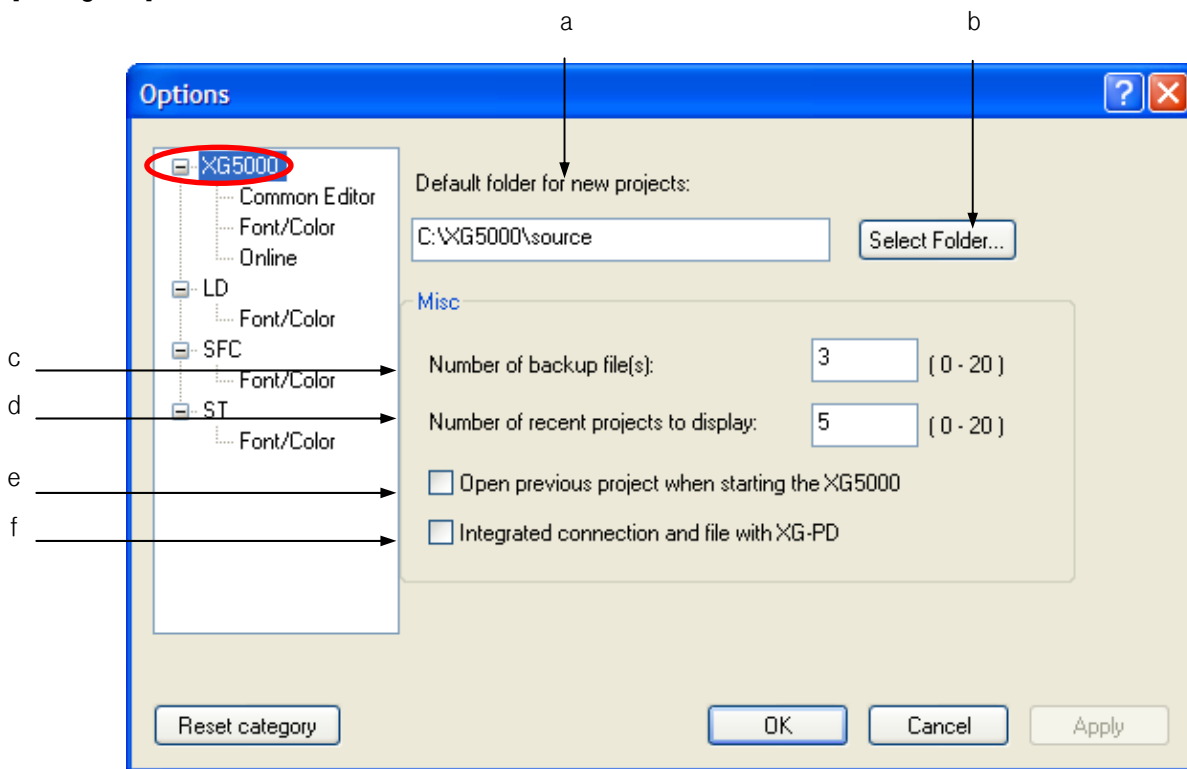

[Description of dialog box]

- a. Default folder for new projects: default folder location when making new project
- b. Select Folder: Search folder
- c. Specifies the number of backup file to restore project file. Up to 20 is available
- d. Specifies the number of recently opened project displayed at menu [Project] – Recent Project]. Up to 20 is available
- e. When starting XG5000, opens the recent project automatically
- f. When executing XG-PD through XG5000 menu, make connection option of XG5000 and PLC name displayed at XG-PD identically.

### 2.6.3 XG5000 Common Editor

[Steps]

Select menu [Tools]-[Options]

Select option after select [Common Editor] in XG5000 category

[Description of dialog box]

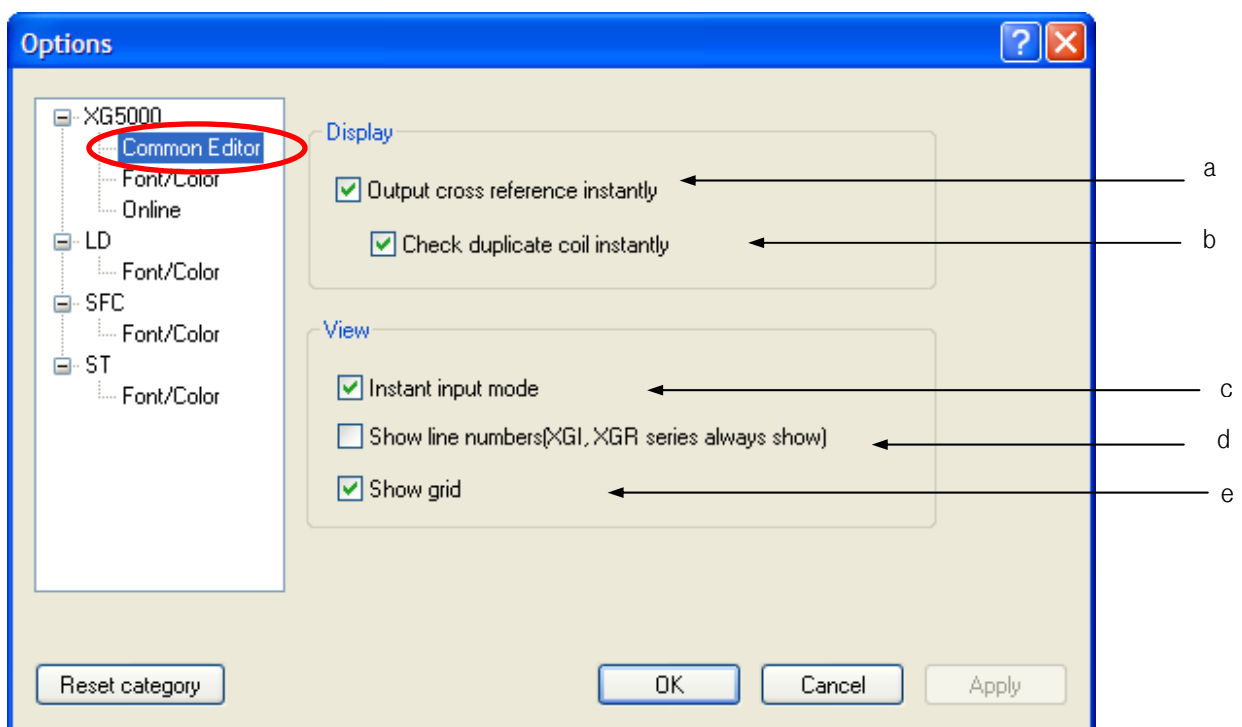

[Description of dialog box]

- a. Output cross reference instantly: for device used in LD, displays memory reference contents automatically. When this option is not selected, you can check the result of memory use by selection [View]-[Cross Reference]
- b. Check duplicate coil instantly: check duplicate coil and display at duplicate coil window during editing
- c. Instant input mode: When inputting contact point, shows device input window for user to input device instantly. When Instant input mode is not selected, move cursor and double-click or press Enter to input device
- d. Show line number: shows line number in editing window.
- e. Show grid: shows grid in editing window

### 2.6.4 XG5000 Color Options

Color to be displayed on the LD/IL Edit Window can be specified by the user.

[Steps]

1. Select [Tools]-[Option] on the menu.
2. Select the Color tap on the Option Dialog Box.

[Dialog Box]

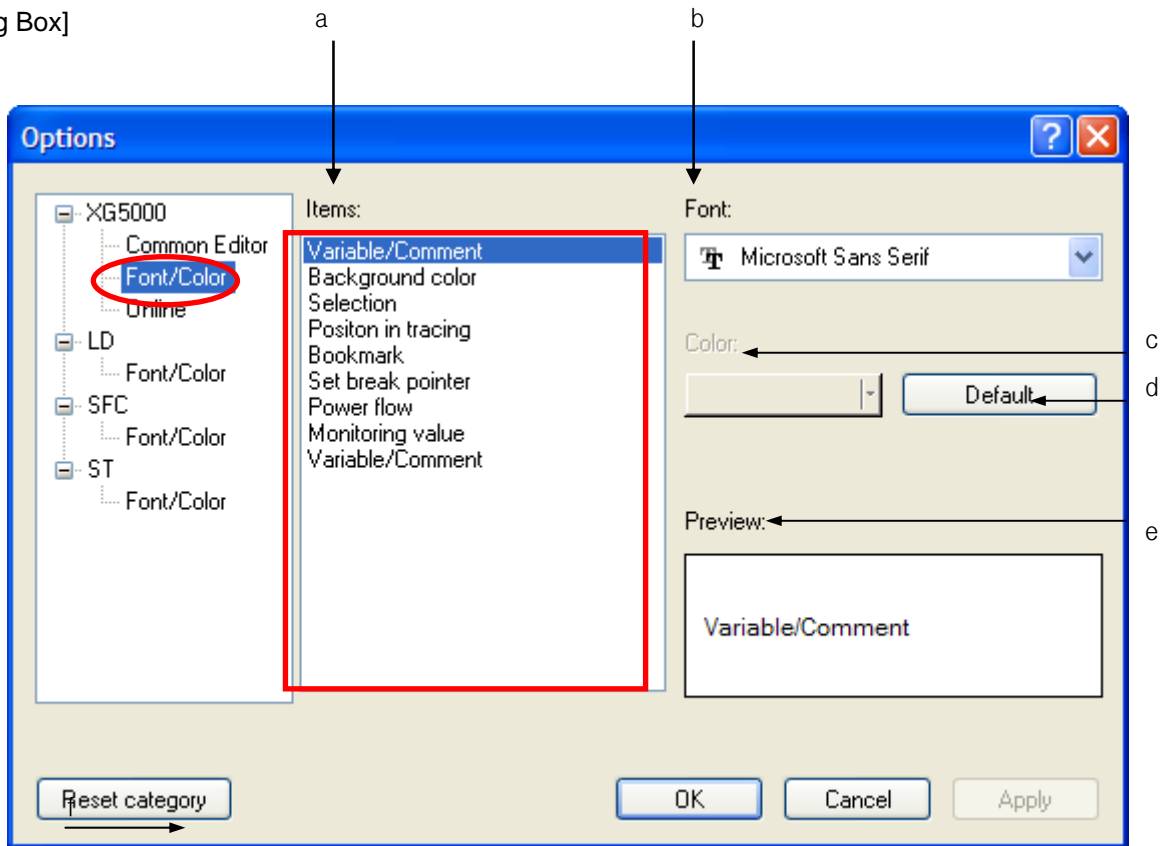

[Description of Dialog Box]

- a. Items: Used to select the area to specify its font or color.
- b. Font: activated when item is Variable/Comment, specifies font of Variable/Comment
- c. Color: activated when item is not Variable/Comment, specifies color
- d. Default: for selected item, restore default value
- e. Preview: displays the setting value of the selected item

## 2.6.5 Online Options

Online related options can be specified.

[Steps]

1. Select [Tools]-[Option] on the menu.
2. Select the Online tap on the Option Dialog Box.

[Dialog Box]

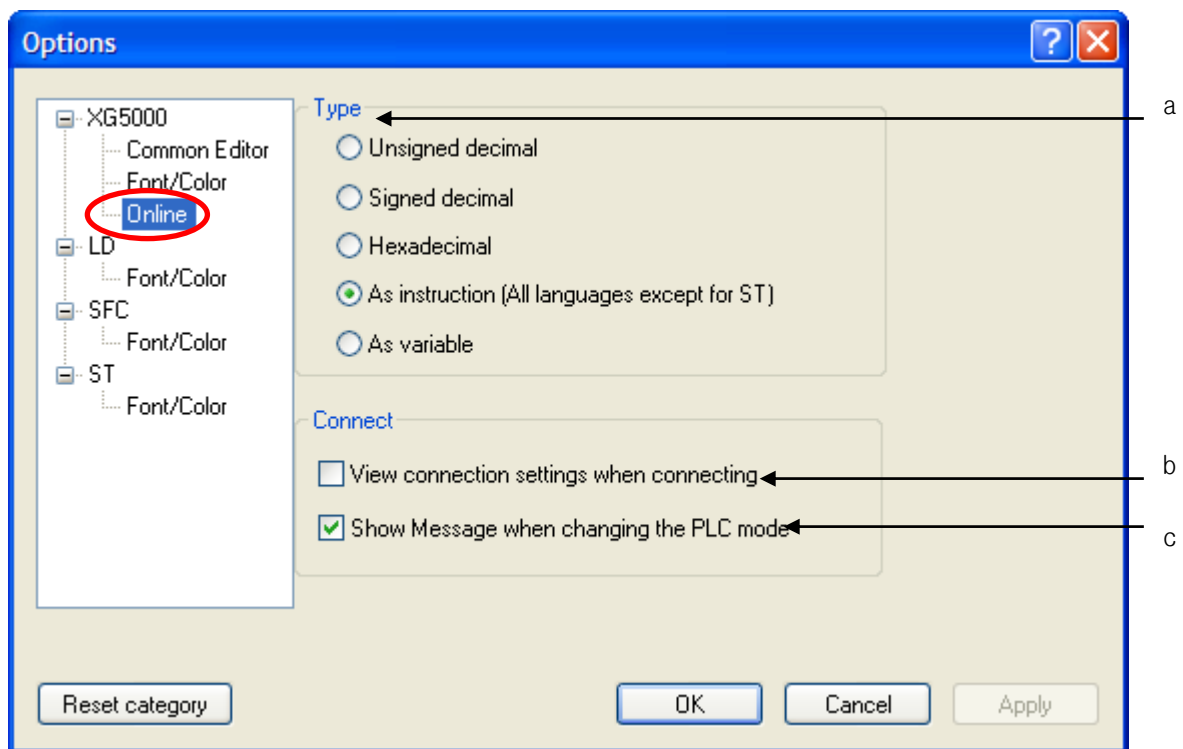

[Description of Dialog Box]

- a. Type: used to specify the display format of the data value.

*Example)* If Hexadecimal is selected on the Monitor Display Format, the variable values when monitored will be displayed in hexadecimal

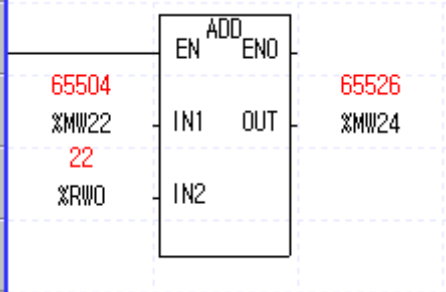
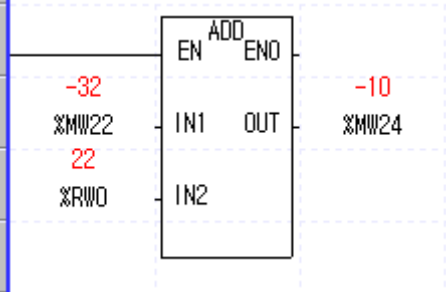
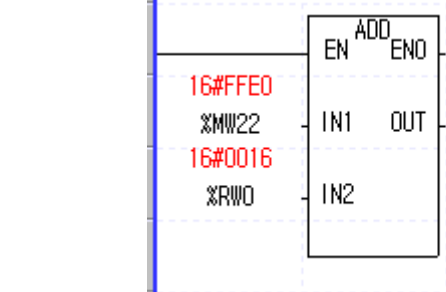
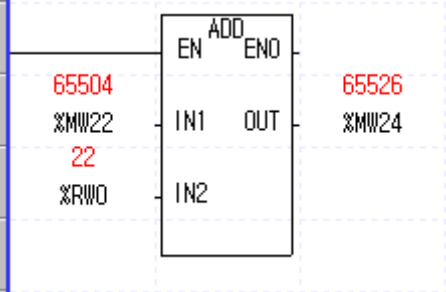

## Chapter 2 Basic Application

Monitor Display Format	<i>Example)</i> Application Instruction ADD
Unsigned Decimal	
Signed Decimal	
Hexadecimal	
As instruction	

b. View connection setting when connecting: used to display the specified details of the connection with PLC automatically when connected. If the option [View connection settings when connecting] is selected, the following Dialog Box will appear whenever PLC is connected with.

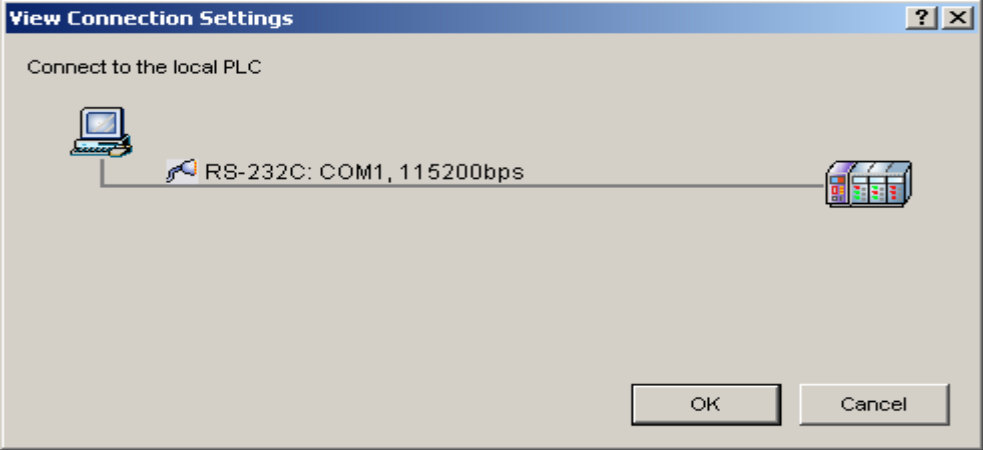

c. Show Message when changing the PLC mode: When changing the PLC mode, displays conversion message automatically. When changing from Stop mode to Run mode, the following message shows.

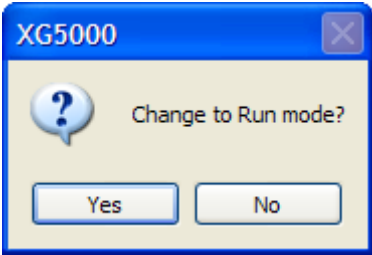

When changing from Run mode to Stop mode, the following message shows



### 2.6.6 LD option

You can change text and column width of LD editor

[Steps]

1. Select [Tools]-[Option] on the menu.
2. After selecting LD category, specify the item for changing

[Dialog box]

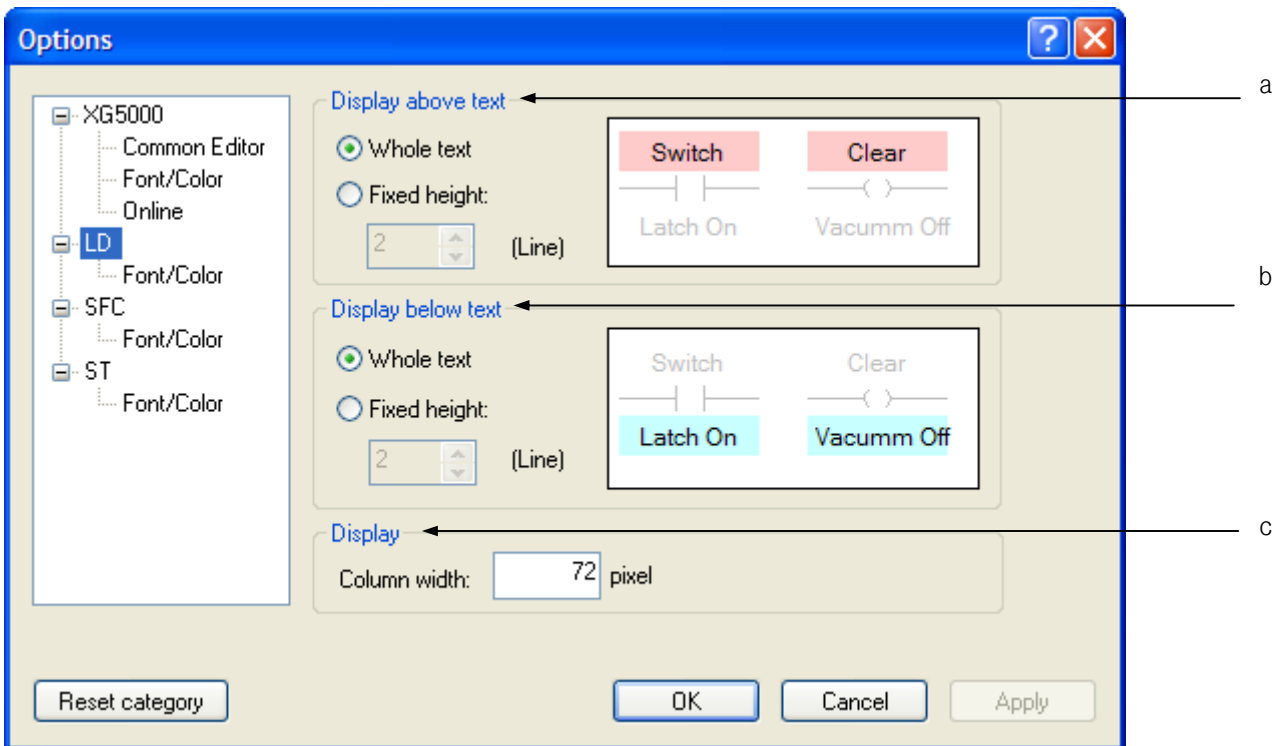

[Description of dialog box]

- a. Display above text: When displaying text above diagram, decides whether to display height of text as variable type according to the number of character or as fixed type according to setting
- b. Display below text: .When displaying text below diagram, decides whether to display height of text as variable type according to the number of character or as fixed type according to setting
- c. Display: specified column width of LD diagram

### 2.6.7 LD Font/Color option

You can change Font/Color used in LD editor

[Steps]

1. Select [Tools]-[Option]
2. After selecting [Font/Color] in LD category, specifies font/color

[Dialog box]

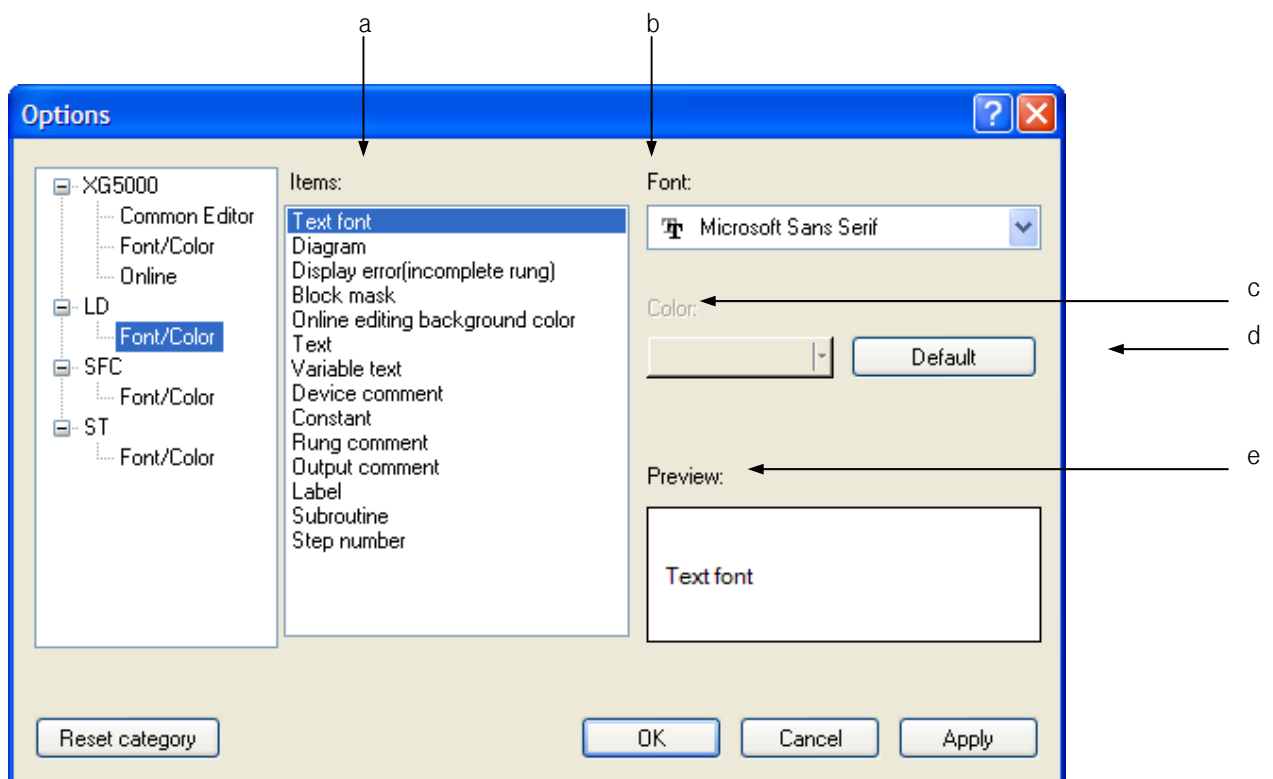

[Description of dialog box]

- a. Items: Used to select the area to specify its font or color.
- b. Font: activated when item is Variable/Comment, specifies font of Variable/Comment
- c. Color: activated when item is not Variable/Comment, specifies color
- d. Default: for selected item, restore default value
- e. Preview: displays the setting value of the selected item

### 2.6.8 SFC option

Options used when editing SFC program

[Steps]

1. Select [Tools]-[Option]
2. Select SFC category

[Dialog box]

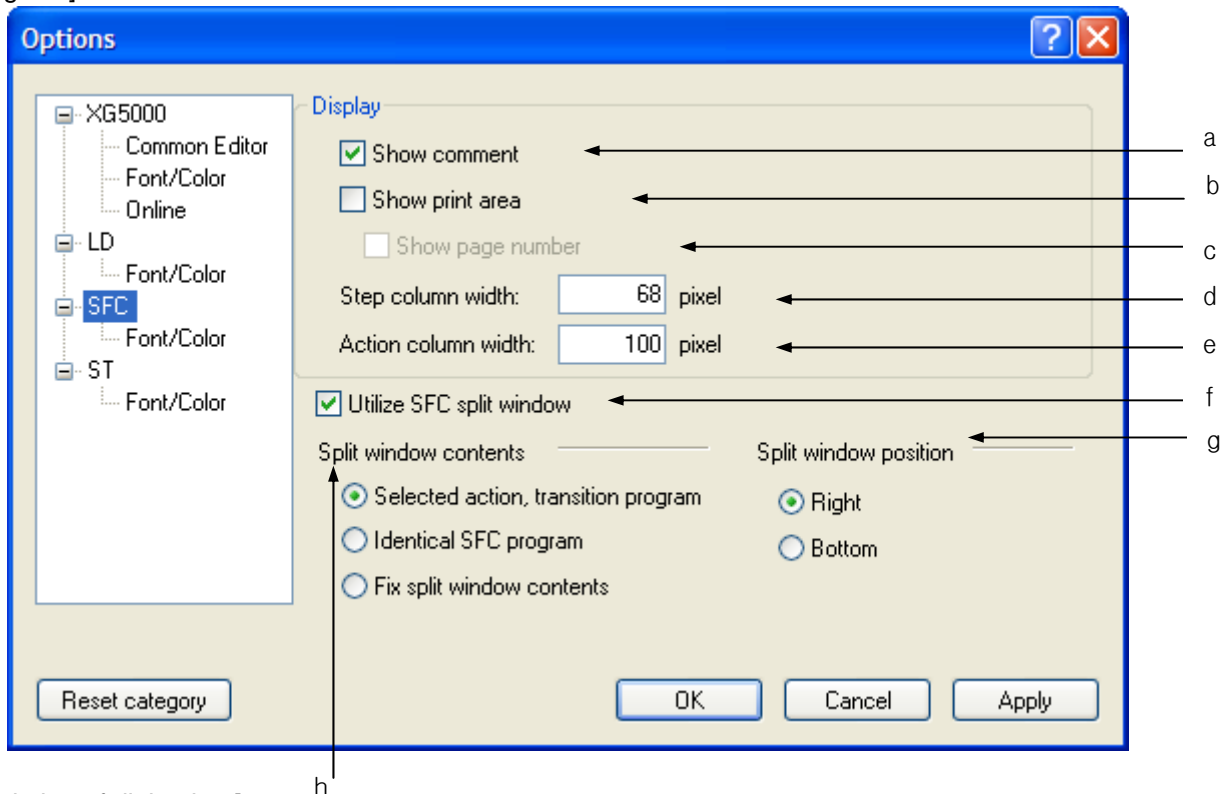

[Description of dialog box]

- a. Show comment: shows comment of step, transition, action and block
- b. Show print area: shows print-able area with the thick dotted line
- c. Show page number: shows page number in print-able area
- d. Step column width: specifies column width of step, transition
- e. Action column width: specifies column width of action.
- f. Utilize SFC split window: you can use SFC split window.
- g. Split window position: decides split widow position
- h. Split window contents: decides which content to display

**Note**

- Range of step column width is 20~200.
- Range of action column width is 70~400.

**2.6.9 SFC Font/Color**

You can change font/color used in SFC editor

[Steps]

1. Select [Tools]-[Option]
2. After changing [Font/Color] in SFC category, specified font/color

[Dialog box]

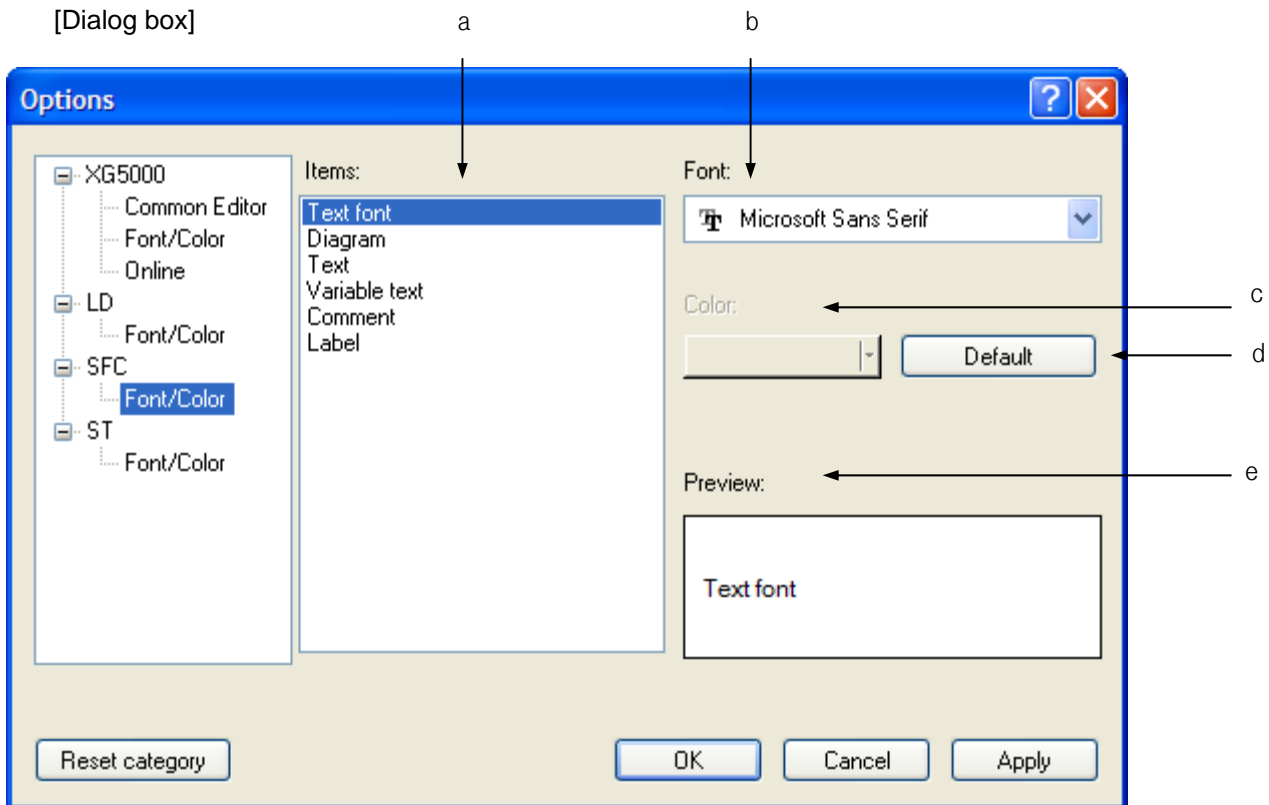

## Chapter 2 Basic Application

[Description of dialog box]

- a. Items: Used to select the area to specify its font or color.
- b. Font: activated when item is Variable/Comment, specifies font of Variable/Comment
- c. Color: activated when item is not Variable/Comment, specifies color
- d. Default: for selected item, restore default value
- e. Preview: displays the setting value of the selected item

### 2.6.10 ST option

Options used in editing ST program.

[Steps]

1. Select [Tools]-[Option].
2. Select ST category

[Dialog box]

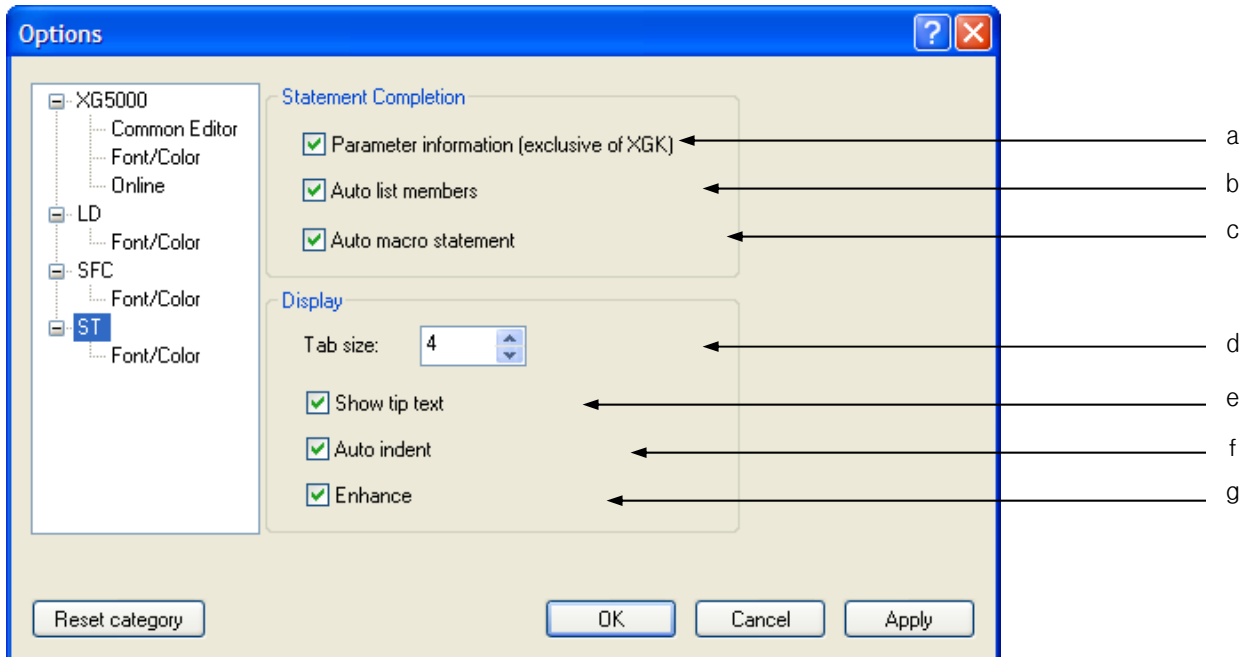

[Description of dialog box]

- a. Parameter information: exclusive of XGK CPU
- b. Auto list members: When inputting character with keyboard, shows instruction and variable starting with inputted character
- c. Auto macro statement: When inputting control statement such as IF, WHILE, SWITCH and pressing Enter key, complete the statement according to ST grammar
- d. Tap size: specifies space size when pressing Tap key
- e. Show tip text: When move cursor on the character string, shows comment on character string
- f. Auto indent: When changing line with Enter key, indented automatically as many as previous tap size.
- g. Enhance: Shows character string with diverse color according to variable, reserved word, comment and instruction



### 2.6.11 ST Font/Color

You can change Font/Color used in ST Editor.

[Steps]

1. Select [Tools]-[Option]
2. after selecting [Font/Color] in ST category, specifies font/color.

[Dialog box]

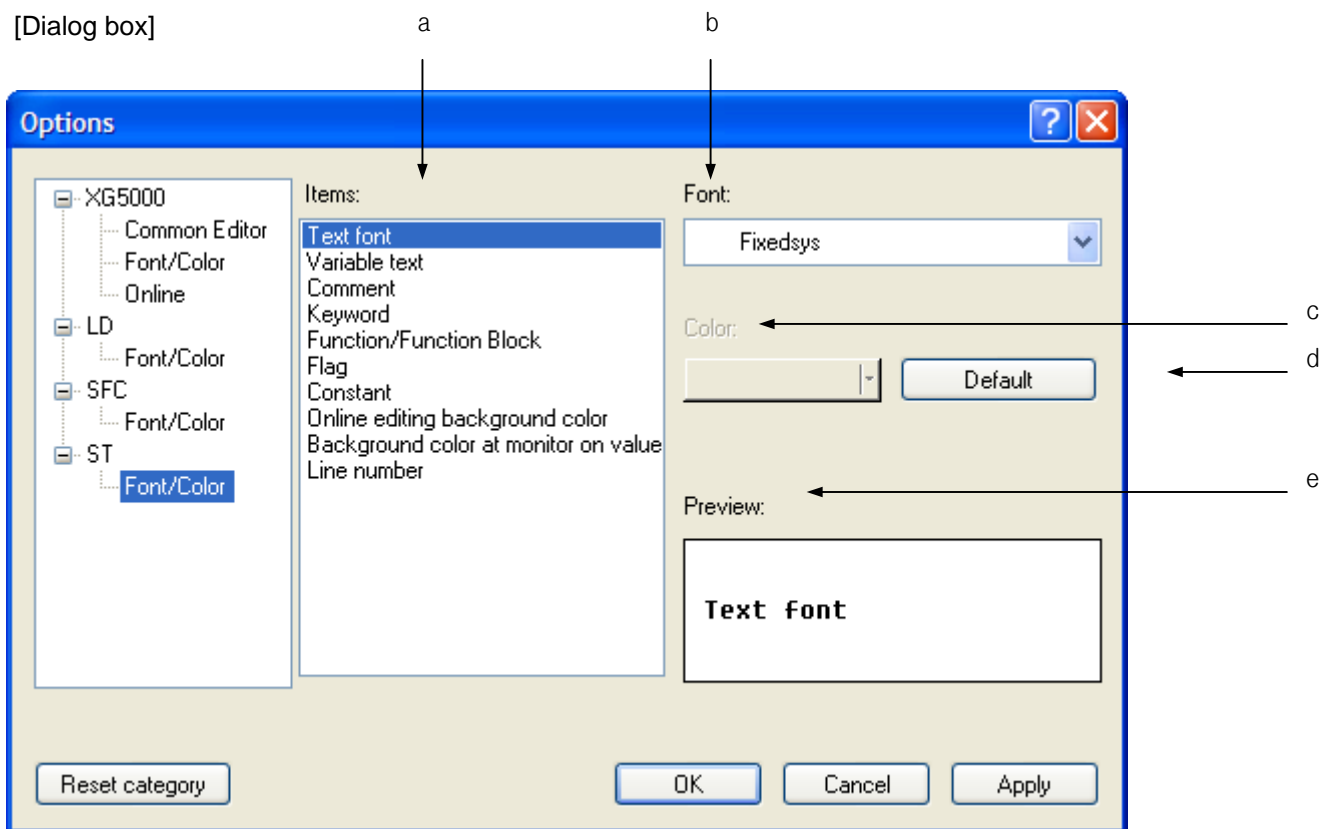

[Description of dialog box]

- a. Items: Used to select the area to specify its font or color.
- b. Font: activated when item is Variable/Comment, specifies font of Variable/Comment
- c. Color: activated when item is not Variable/Comment, specifies color
- d. Default: for selected item, restore default value
- e. Preview: displays the setting value of the selected item

# Chapter 3 Project

## 3.1 Project Configuration

The items of the project configuration are follows.

[Dialog Box]

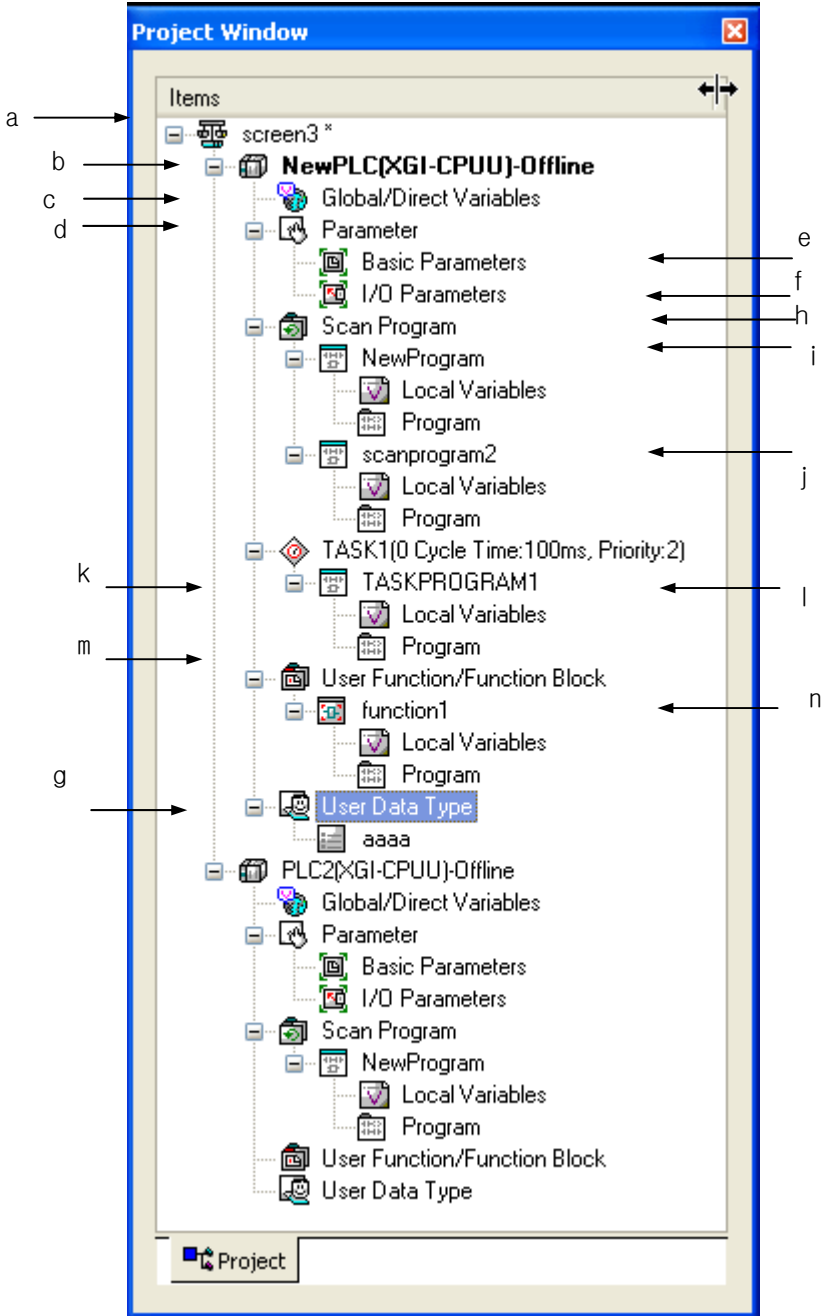

## Chapter 3 Project

[Description of Dialog Box]

- a. Project: used to specify the whole system. Several PLCs related can be included in one project.
- b. PLC: displays the system applicable to a CPU module.
- c. Global/Direct Variables: global variable declaration and direct variable text can be edited and viewed.
- d. Parameter: used to specify the details on operation and configuration of PLC system.
- e. Basic Parameters: used to specify the basic operation.
- f. I/O Parameters: used to specify the I/O module configuration.
- g. User Data type: defines a structure type.
- h. Scan Program: used to specify the program always executable in the sub-item.
- i. New program: means the user defined program always executable.
- j. Program 2: means the user defined program always executable.
- k. Task: means the user defined task with a fixed cycle.
- l. Task Program1: program executed under the task 1 conditions
- m. User function/function block: a user creates function/function block in a sub-item.
- n. Function1: function created by a user.

### Notes

- Several PLCs can be included in one project. In this way, with several PLC included in one project its management will be convenient, and monitoring several PLCs will be also available through simultaneous connection to several PLCs with one running XG5000.

## 3.2 Project File Management

### 3.2.1 New Project

It is used to create a new project. At this moment, a folder whose name is identical to the project name will be also created, where the project file will be created.

[Steps]

1. Select [Project]-[New Project] on the menu.

[Dialog Box]

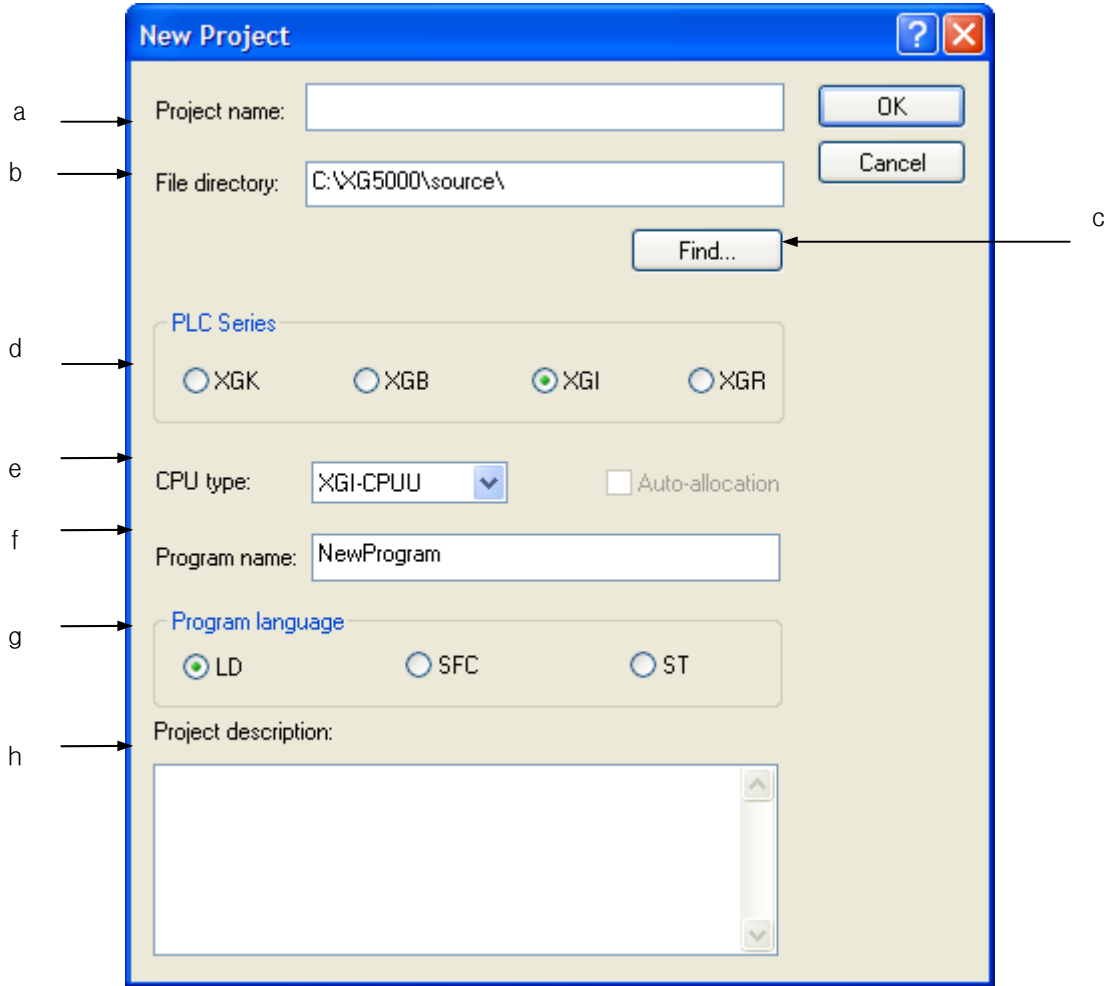

## Chapter 3 Project

---

[Description of Dialog Box]

- a. Project name: used to input the desired project name, which will be the name of the project file. The extension of the project file will be “.xgp”.
- b. File directory: a folder whose name is identical to the project name as specified by the user will be created and there the project file will be created.
- c. Find: used to specify the project file location after searching for the existing folders.
- d. Project type: selects XGK or XGB or XGI format (IEC programming). Once it is selected, the two formats are not compatible one another.
- e. PLC type: used to select the PLC unit.
- f. Program name: enters a name of program included in a project as the default.
- g. Program language: selects a language of program included in a project as the default.
- h. Project description: used to input the project description.

### Notes

**Project File:** If a new project is created, a folder whose name is identical to the project file name will be created, where the project file will be created inside. The extension of “.xgp” will be automatically attached to the project file if not specified.

### 3.2.2 Open Project

[Steps]

1. Select [Project]-[Open Project] on the menu.

[Dialog Box]

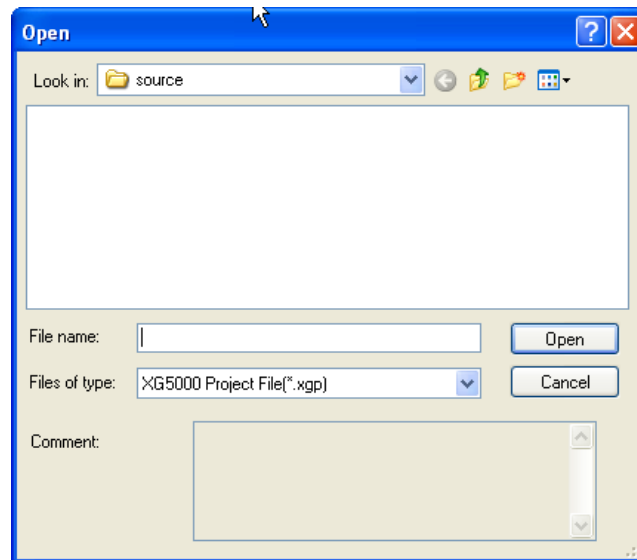

2. If Project File is selected, user defined comment will appear on the comment which will help the user to select the project. If project file is selected, Click [Open].

### 3.2.3 Open from PLC

It is used to read the project stored in PLC to make a new project. If the project is already open in XG5000, this project will be closed to create a new project.

[Steps]

1. Select [Project]-[Open from PLC] on the menu.

## Chapter 3 Project

[Dialog Box]

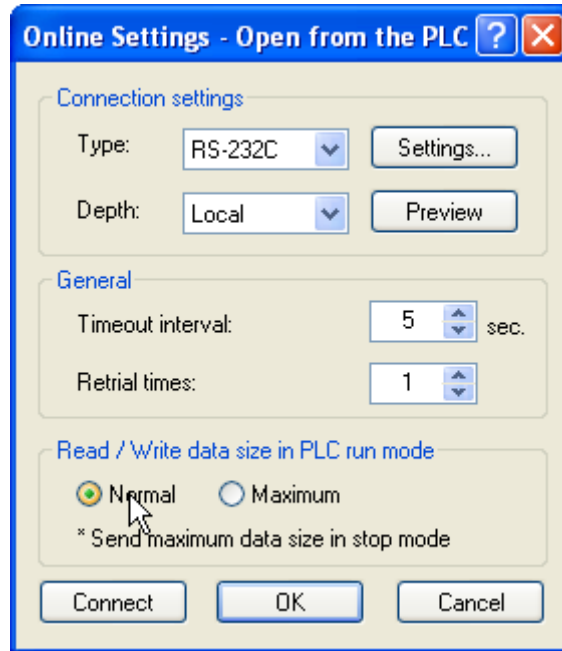

2. Select the object to connect to on the [Online Settings] and click [OK]. Refer to Connect Options in Online for details on connection settings.
3. A new project will be created.

### Notes

- The project read from PLC will be saved in PC through the menu [Project]-[Save Project]

### Notes

- Select [Online]-[Read] to read the items of PLC and import to the presently Open Project.

### 3.2.4 Save Project

It is used to save the changed project.

[Steps]

1. Select [Project] - [Save Project] on the menu.

Notes

- If items of project is changed and needed to be saved, "\*" will be displayed at the side of the project name of the project window.

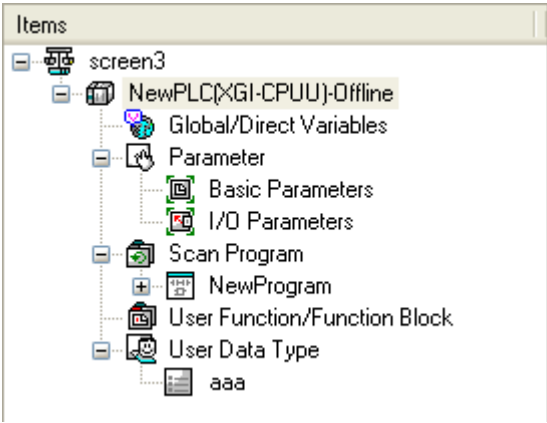

3.2.5 Save as

It is used to save the project as a different file name.

[Steps]

1. Select [Project]-[Save As] on the menu.
2. Input a new project file name and select a folder where project file will be saved and click [OK] button.

[Dialog Box]

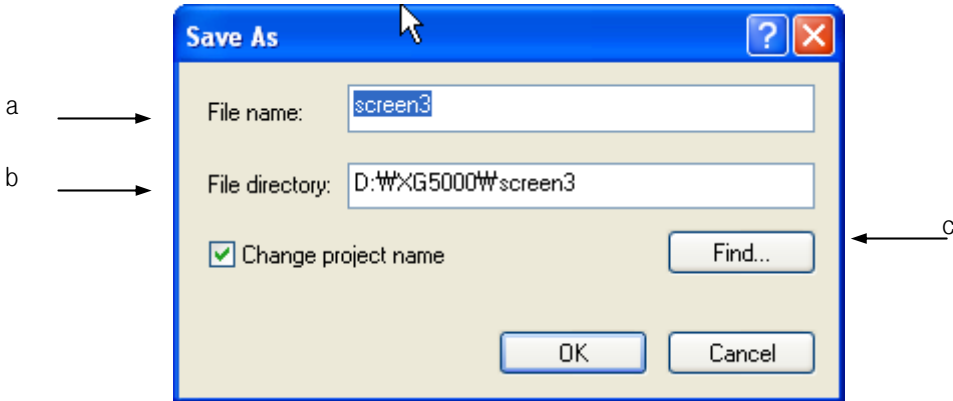



## Chapter 3 Project

---

[Description of Dialog Box]

- a. File name: used to input the desired project name, which will be the name of the project file. The extension of the project file will be “.xgp”.
- b. File directory: a folder whose name is identical to the project name as specified by the user will be automatically created, where the project file will be created.
- c. Find: used to specify the project file location after searching for the existing folders.

## 3.3 Open GMWIN File

### 3.3.1 Open GMWIN File

It is used to read GMWIN project file in XG5000 to convert to XG5000 project. The list of the convertible items is as follows

- Program (LD)
- Direct variable comment
- Global variable

The list of items excluded from conversion of the GMWIN project file is as follows.

- Basic Parameter
- I/O Parameter
- High speed link
- IL, SFC Program

[Steps]

1. Select [Project] - [Open GMWIN File] on the menu.
2. Select the folder where GMWIN project to open is stored in and select KGLWIN project file to convert to XG5000 project

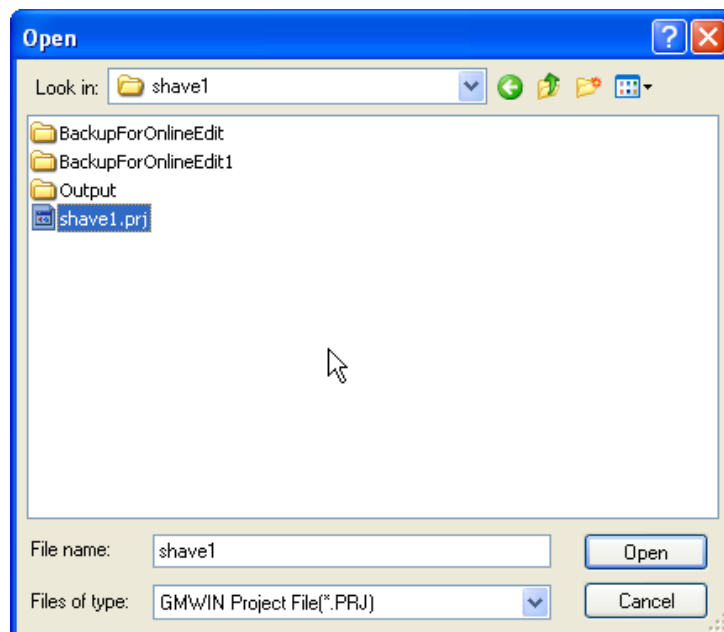

## Chapter 3 Project

3. Click Open to display the New Project Dialog Box.

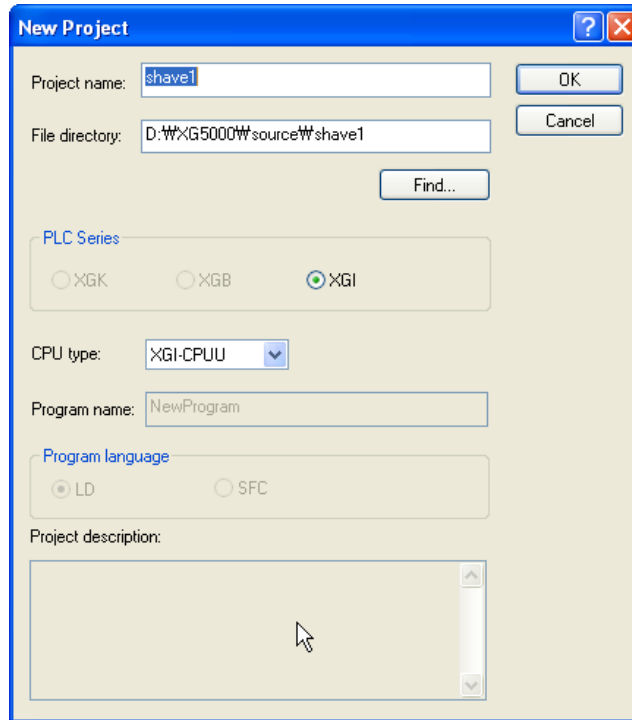

4. Enter project name and PLC type and click [OK]. Then, it converts GMWIN file and creates XG5000 project.

### 3.3.2 GMWIN Project Conversion Rules

It converts a program created by GMWIN. The items converted to XG5000 are contact (type), coil (type), horizontal line, vertical line, rung comment, function/function block, extended functions such as JMP and SCAL.

#### a. Basic conversion

Items like contact (type), coil (type), horizontal line and vertical line are converted alike in GMWIN and displayed accordingly. However, the variables used in contact and coil may be converted to other types under the XG5000 display specifications and displayed accordingly. For the details of GMWIN variable conversion, refer to 2) Converted Items of Variable Name.

#### b. Conversion of Extended Function

Other functions but the basic items such as label, jump and etc are converted to extended function. The changed extended functions are as follows.

Item	Changed item	GMWIN	XG5000
RET	RET		
JMP	JMP		
SCAL	CALL		
Label	Label		
Subroutine label	SBRT		
End of main program	END		
INIT_DONE output	INIT_DONE		

**Notes**

- The label referred to subroutine in GMWIN file is changed to the extended function SBRT.

c. Conversion of Function/Function Block

In case of function/function block, it converts the only standard function/function block and APP library of GMWIN. A program using any function/function block not included in the library is not normally converted.

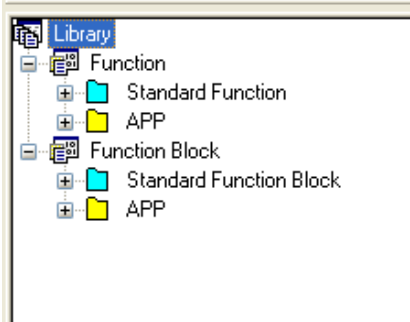

## Chapter 3 Project

### Notes

- Any other function/function block save for the standard function/function block and APP library is converted to the following dummy function.

Function		Function block	
Function name		Instance name	
EN	ENO	EN	ENO
IN1	OUT1	IN1	OUT1
IN2	OUT2	IN2	OUT2
...	...	...	...
INN	OUTN	INN	OUTN

- Function/Function block

There are functions of which type is changed although they are contained in the standard function/function block and APP library. For the function type changed, refer to the following table.

Function (GMWIN)	Changed function(XG5000)
ABS	ABS
ACOS	ACOS
ADD	ADD
ADD_TIME	ADD_TIME
AND	AND
ARY_AVE_type	ARY_AVE
ARY_CMP_type	ARY_CMP
ARY_FLL_type	ARY_FLL
ARY_MOVE	ARY_MOVE
ARY_SCH_type	ARY_SCH
ARY_TO_STRING	BYTE_STRING
ASC_TO_BCD	ASC_TO_***
ASC_TO_BYTE	
ASIN	ASIN
ATAN	ATAN
BCD_TO_type	BCD_TO_***
BIT_BYTE	BIT_BYTE

Function (GMWIN)	Changed function(XG5000)
BMOVE_type	BMOVE
BOOL_TO_type	BOOL_TO_***
BSUM_type	BSUM
BYTE_TO_type	BYTE_TO_***
BYTE_WORD	BYTE_WORD
CONCAT	CONCAT
CONCAT_TIME	CONCAT_TIME
COS	COS
DATE_TO_type	DATE_TO_***
DEC_type	DEC
DECO_type	DECO
DEG_type	DEG
DELETE	DELETE
DI	DI
DINT_TO_type	DINT_TO_***
DIREC_IN	DIREC_IN
DIREC_O	DIREC_O
DIV	DIV
DIV_TIME	DIV_TIME
DT_TO_type	DT_TO_***
DWORD_LWORD	DWORD_LWORD
DWORD_TO_type	DWORD_TO_***
EI	EI
EQ	EQ
ENCO_type	ENCO
ESTOP	ESTOP
EXP	EXP
EXPT	EXPT
FIND	FIND
GE	GE
GET_CHAR	GET_CHAR
GT	GT
INC_type	INC
INSERT	INSERT
INT_TO_type	INT_TO_***

## Chapter 3 Project

Function (GMWIN)	Changed function(XG5000)
LE	LE
LEFT	LEFT
LEN	LEN
LIMIT	LIMIT
LINT_TO_type	LINT_TO_***
LN	LN
LOG	LOG
LREAL_TO_type	LREAL_TO_***
LT	LT
LWORD_TO_type	LWORD_TO_BOOL
MAX	MAX
MCS	MCS
MCSCCLR	MCSCCLR
MEQ_type	MEQ
MID	MID
MIN	MIN
MOD	MOD
MOVE	MOVE
MUL	MUL
MUL_TIME	MUL_TIME
MUX	MUX
NOT	NOT
NE	NE
NUM_TO_STRING	(type)_TO_STRING
OR	OR
PUT_CHAR	PUT_CHAR
RAD_	RAD
RAD_REAL	
REAL_TO_type	REAL_TO_***
REPLACE	REPLACE
RIGHT	RIGHT
ROL	ROL
ROR	ROR
ROTATE_A_type	ROTATE_A
ROTATE_C_type	ROTATE_C
SEG_WORD	SEG_WORD

Function (GMWIN)	Changed function(XG5000)
SEL	SEL
SHIFT_A_type	SHIFT_A
SHIFT_C_type	SHIFT_C
SHL	SHL
SHR	SHR
SIN	SIN
SINT_TO_type	SINT_TO_***
SQRT	SQRT
STOP	STOP
STRING_TO_type	STRING_TO_***
SUB	SUB
SUB_date_type	SUB_DATE
SWAP_type	SWAP
TAN	TAN
TIME_TO_type	TIME_TO_***
TOD_TO_type	TOD_TO_***
TRUNC	TRUNC
UDINT_TO_type	UDINT_TO_***
UINT_TO_type	UINT_TO_***
ULINT_TO_type	ULINT_TO_***
UNI_type	UNI
USINT_TO_type	USINT_TO_***
WDT_RST	WDT_RST
WORD_BYTE	WORD_BYTE
WORD_DWORD	WORD_DWORD
WORD_TO_type	WORD_TO_***
XCHG_type	XCHG
XOR	XOR



## Chapter 3 Project

Function block(GMWIN)	Changed function block (XG5000)
CTD	CTD_INT
CTR	CTR_INT
CTU	CTU_INT
CTUD	CTUD_INT
DUTY	DUTY
F_TRIG	F_TRIG
FIFO_type	FIFO
LIFO_type	LIFO
R_TRIG	R_TRIG
RS	RS
RTC_SET	RTC_SET
RTC_SET1	RTC_SET1
SCON	SCON
SEMA	SEMA
SR	SR
TMR	TMR
TMR_FLK	TMR_FLK
TMR_UINT	TMR_UINT
TOF	TOF
TOF_RST	TOF_RST
TOF_UINT	TOF_UINT
TON	TON
TP	TP
TP_RST	TP_RST
TP_UINT	TP_UINT
TRTG	TRTG
TRTG_UINT	TRTG_UINT

- Function/function block of which I/O parameter is changed

Function name	Changes
ARY_ASC_TO_***	I/O type IN2 → Output OUT
ARY_***_TO_ASC	I/O type IN2 → Output OUT
WORD_BYTE	I/O type LOW, HIGH → Output LOW, HIGH
DWORD_WORD	I/O type LOW, HIGH → Output LOW, HIGH
LWORD_DWORD	I/O type LOW, HIGH → Output LOW, HIGH
BYTE_BIT	I/O type Q01~Q08 → Output Q01~Q08
ARY_SWAP	I/O type IN2 → Output OUT
ARY_SFT_C	I/O type CY0 → Delete output CY0, output type OUT
ARY_ROT_C	I/O type CY0 → Delete output CY0, output type OUT
ARY_SCH	I/O type P, N → Output P, N
DIS	I/O type IN2 → Output OUT
STRING_BYTE	I/O type IN2 → Output OUT
ARRAY_MOVE	I/O type IN2 → Output OUT

#### Notes

- In case of system flag and COM flag It may not exist in XG5000 or its type may be changed. For the items of flag, refer to the User's Manual of PLC.

### 3.4 Project Item

#### 3.4.1 Add item

PLC, task and program can be inserted into the project additionally.

##### 1) Add PLC

[Steps]

1. On the project window, select the Project Item.

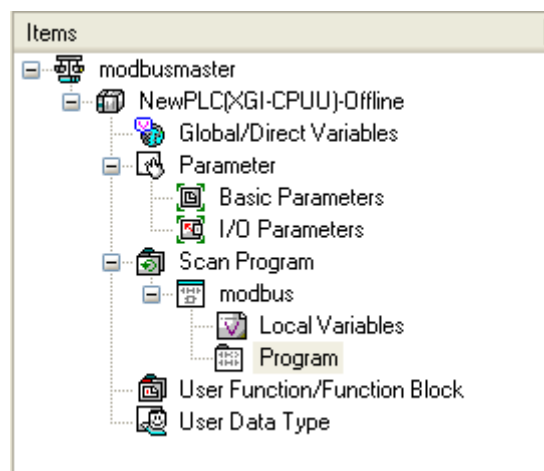

2. Select [Project]-[Add Item]-[PLC] on the menu.

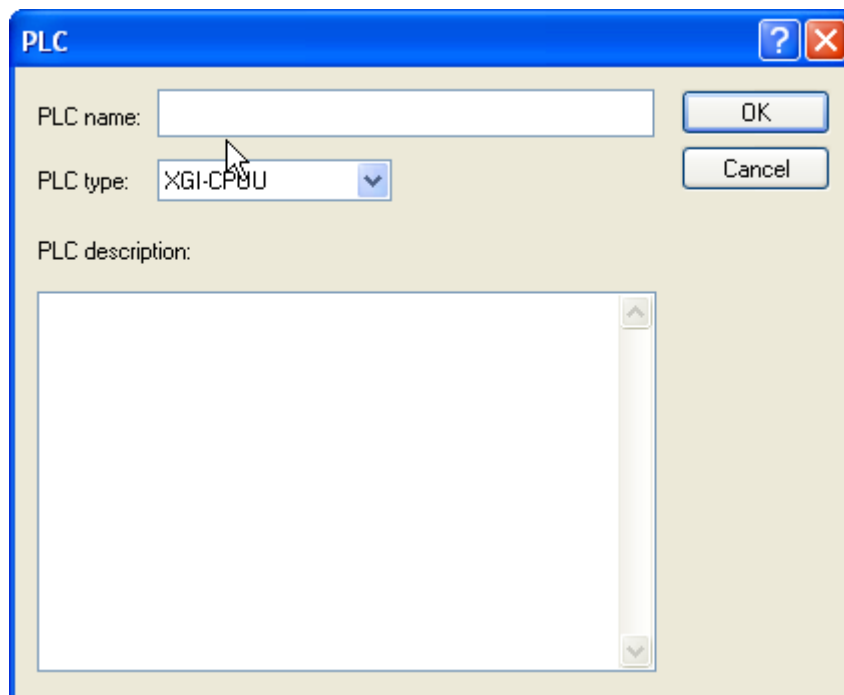

3. Input PLC name, PLC type and PLC Description, and then click [OK] to create a new PLC as shown below.

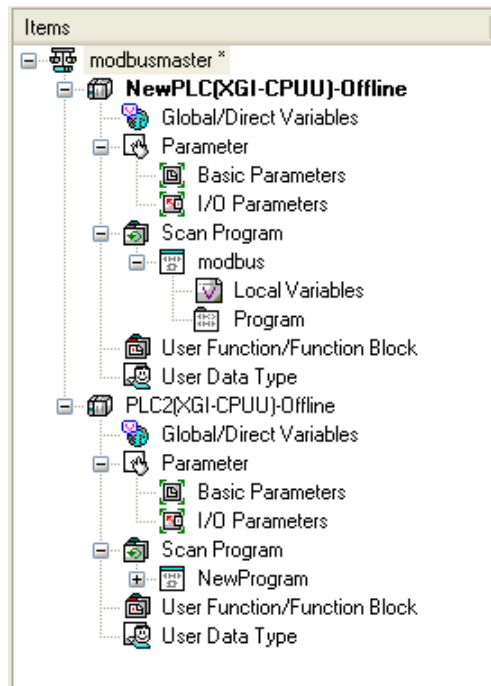

**Notes**

- PLC is kind of a project as in previous KGLWIN. XG5000 allows the user to specify the project as a unit of PLC and include several projects (PLC) in one project to manage conveniently.

2) Add Task

**Notes**

- Refer to XGT CPU manual for more information on the operation and the details of the task.

## Chapter 3 Project

[Steps]

1. On the project window, select the PLC Item

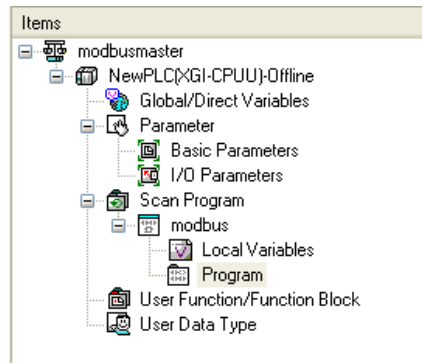

2. Select [Project]-[Add Item]-[Task] on the menu.

[Dialog Box]

- a →
- b →
- c →
- d →

Task

Task name:

Priority: 2

Task number: 0 (Cycle time: 0~31, I/O: 32~63, Internal device: 64~95)

Execution condition

Initialization

Cycle time  ms

I/O  (0~7)

I/O execution conditions

Rising  Falling  Transition

Internal device BIT

Internal device execution conditions

Device:  <  0

Rising  Falling  Transition  On  Off

OK Cancel

- e →
- f →
- h →

### [Description of Dialog Box]

- a. Task name: used to input a desired task name. Korean, English and figures can be used except for special characters.
- b. Priority: used to specify the priority of the tasks. The less the figure is, the higher the priority is.
- c. Task number: used to manage the tasks in PLC. According to the execution condition, the number specified in the right shall be used. Ex.) Fixed Cycle: 0 ~ 31
- d. Execution condition: used to specify the execution condition under which the task will be executed.

### Notes

- Execution condition may be different according to the PLC type.
- Initialization: It is the task to be executed when PLC mode is converted from Stop to Run. It will be executed till the \_INIT\_DONE (F10250) Flag is ON. And while the initialization task is executed, the programs (including the Scan Program) which belong to other task will not be executed.
- Fixed Cycle: The task will be executed at an interval of specified time. The time shall be inputted in ms unit.
- External contact point: The task will be executed if specified external contact point is ON. The relative external device should be entered.  
Example) %QX0.0.1
- Internal device: The task will be executed based on the status of internal device. The setup item will be different according to the type of internal device.

- e. Internal device execution condition: setting items are different according to the type of internal device.
- f. Device: used to input the device name which will be used as the start condition of task program. Input BIT or WORD device according to the condition to execute task program.
- g. Word device start condition: The start condition shall be specified if WORD type of the internal device start condition is selected.
- h. Bit device start condition: The start condition shall be specified if BIT type of the internal device start condition is selected.

## Chapter 3 Project

3. Input Task name, Priority, Task Number and Execution Condition, and then click [OK] to create a new Task as shown below.

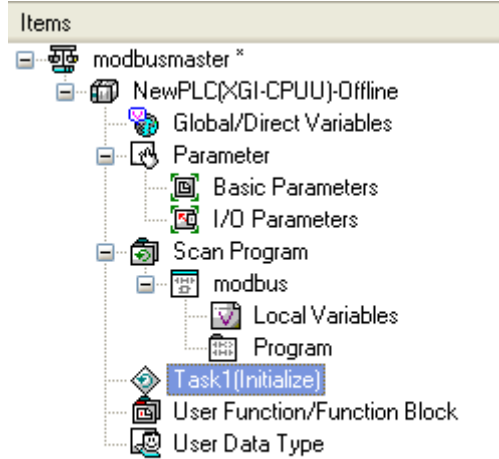

### 3) Add Program

[Steps]

1. On the project window, select the Program Location to add.  
The program can be added to Scan Program or Task Item.

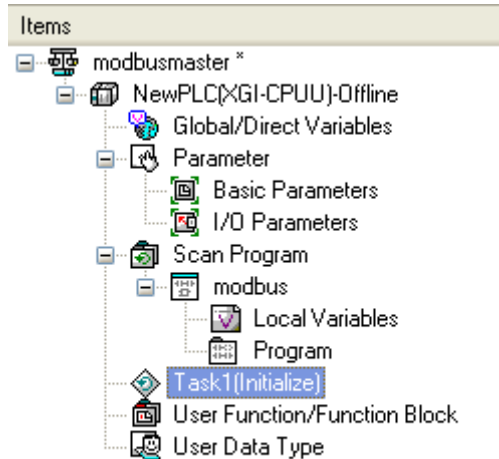

2. Select [Project]-[Add Item]-[Program] on the menu.

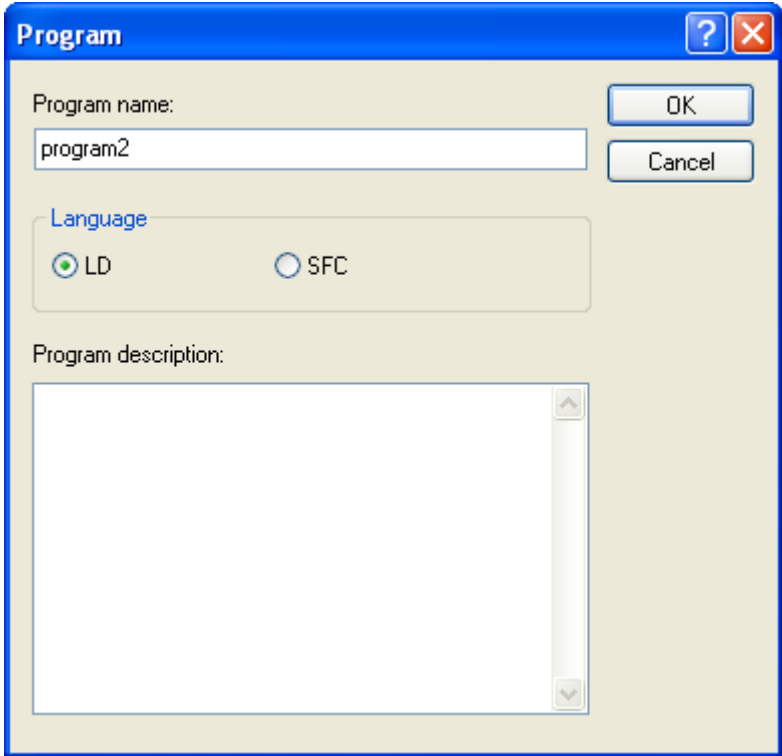

3. Input Program name, language and Program Description, and then click [OK].

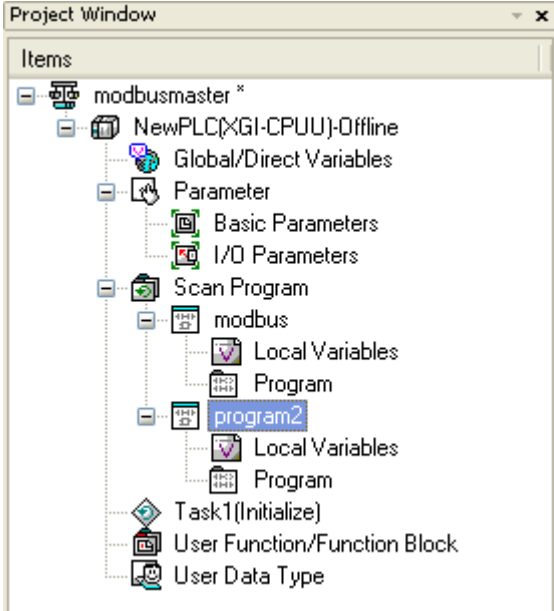



## Chapter 3 Project

### 3.4.2 Import item from file

The following items can be saved as separate item files and replaced by saved item file.

Item	File extension
PLC	cfg
Global/direct variables	gdv
I/O parameter	iop
Basic parameter	bsp
Program	prg
User function/function block	fun

Imports item from saved item files. The contents from PLC, program is inserted into project. Variable/comment, basic parameter, I/O parameter, etc. is overwritten on the previous item.

#### Notes

- Since Variable/Comment, Basic Parameters and I/O Parameters are overwritten on the existing items, the content of the existing item will be erased.

#### 1) PLC

[Steps]

1. On the project window, select the Project Item.

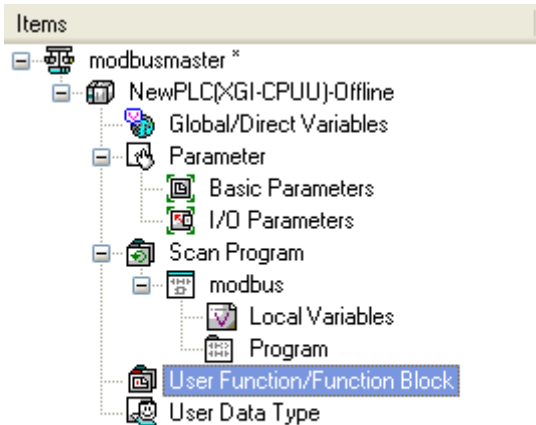

2. Select [Project]-[Import Item from File]-[PLC] on the menu.
3. Select the file, and then click [OK].

2) Variable/Comment

[Steps]

1. On the project window, select the PLC Item.

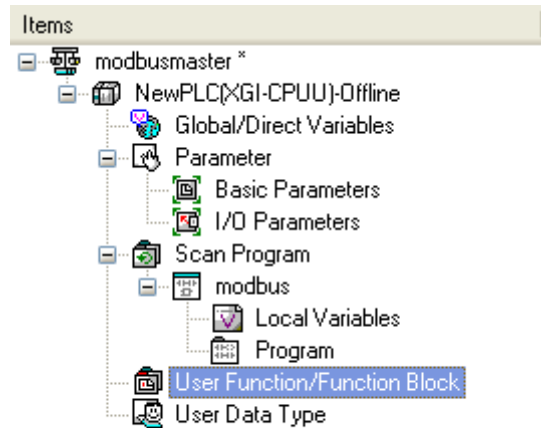

2. Select [Project] – [Import Item from File]-[Variable/Comment] on the menu.

3. Select the file, and then click [OK].

3) I/O Parameter

[Steps]

1. On the project window, select the PLC Item.

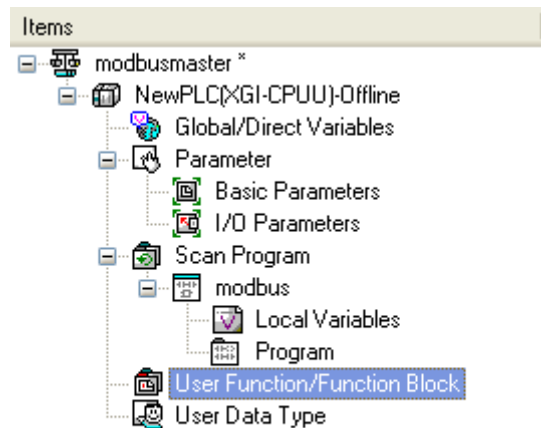

2. Select [Project]-[Import Item from File]-[I/O Parameter] on the menu.

3. Select the file, and then click [OK].

## Chapter 3 Project

### 4) Basic Parameter

[Steps]

1. On the project window, select the PLC Item.

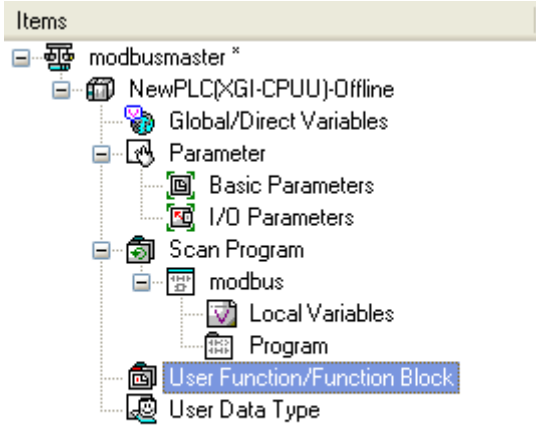

2. Select [Project]-[Import Item from File]-[Basic Parameter] on the menu.
3. Select the file, and then click [OK].

### 5) Program

[Steps]

1. On the project window, select the Program Location to add.  
The program can be added to Scan Program or Task Item.

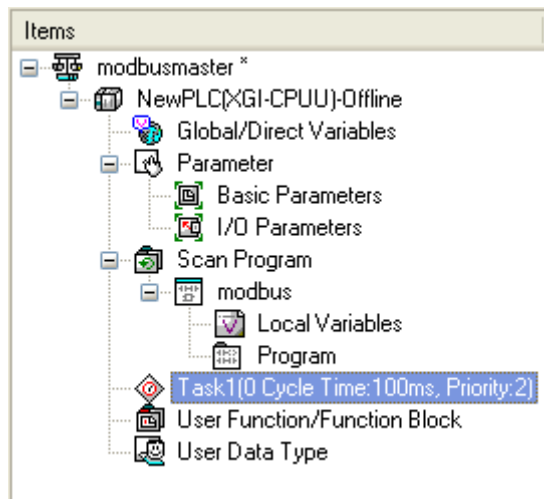

2. Select [Project]-[Import Item from File]-[Program] on the menu.
3. Select the file, and then click [OK].

### 3.4.3 Export to file

The following items can be saved as separate item files.

Item	File Extension
PLC	cfg
Global/direct variables	gdv
I/O parameter	iop
Basic parameter	bsp
Program	prg
Use function/function block	fun

#### 1) PLC

[Steps]

1. On the project window, select the PLC Item.

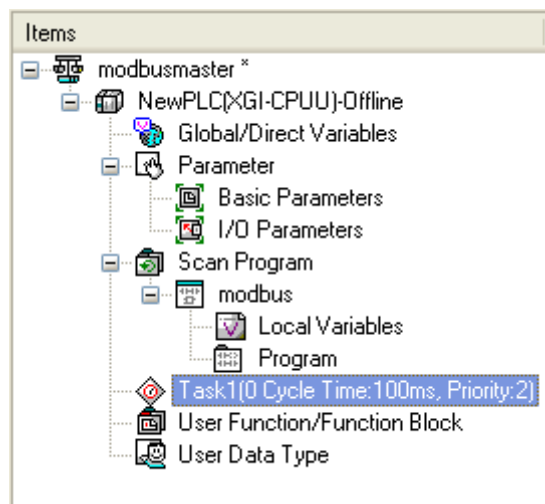

2. Select [Project] – [Export to File]-[PLC] on the menu.

3. Input the file name, and then click [OK].

#### 2) Variable/Comment

[Steps]

1. On the project window, select the Variable/Comment Item.
2. Select [Project] - [Export to File]-[Variable/Comment] on the menu.
3. Input the file name, and then click [OK].

## Chapter 3 Project

---

### 3) I/O Parameters

#### [Steps]

1. On the project window, select the I/O Parameter Item.
2. Select [Project] - [Export to File] - [I/O Parameter] on the menu.
3. Input the file name, and then click [OK].

### 4) Basic Parameters

#### [Steps]

1. On the project window, select the Basic Parameter Item.
2. Select [Project] - [Export to File] - [Basic Parameter] on the menu.
3. Input the file name, and then click [OK].

### 5) Program

#### [Steps]

1. On the project window, select the Program Item.
2. Select [Project] - [Export to File] - [Program] on the menu.
3. Input the file name, and then click [OK].

#### Notes

- Items can be easily copied or moved between the projects with Drag and Drop function.
- Especially, drag and drop function is available between projects, when two XG5000 are executed.

### 3.4.4 Item register information

The name and comment of respective item can be viewed to change.

1) Project properties

[Steps]

1. On the project window, select the Project Item.

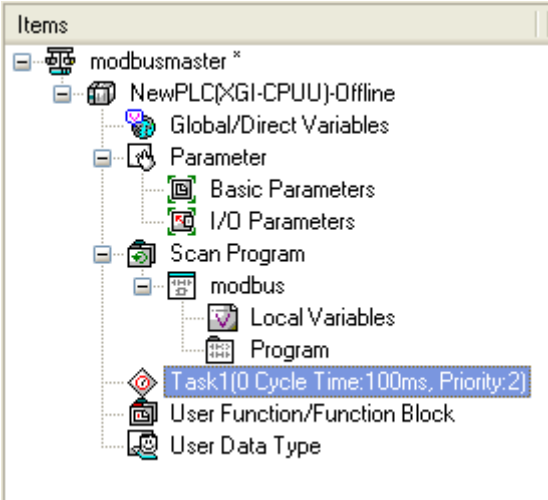

2. Select [View] - [Properties] on the menu.

[Dialog Box]

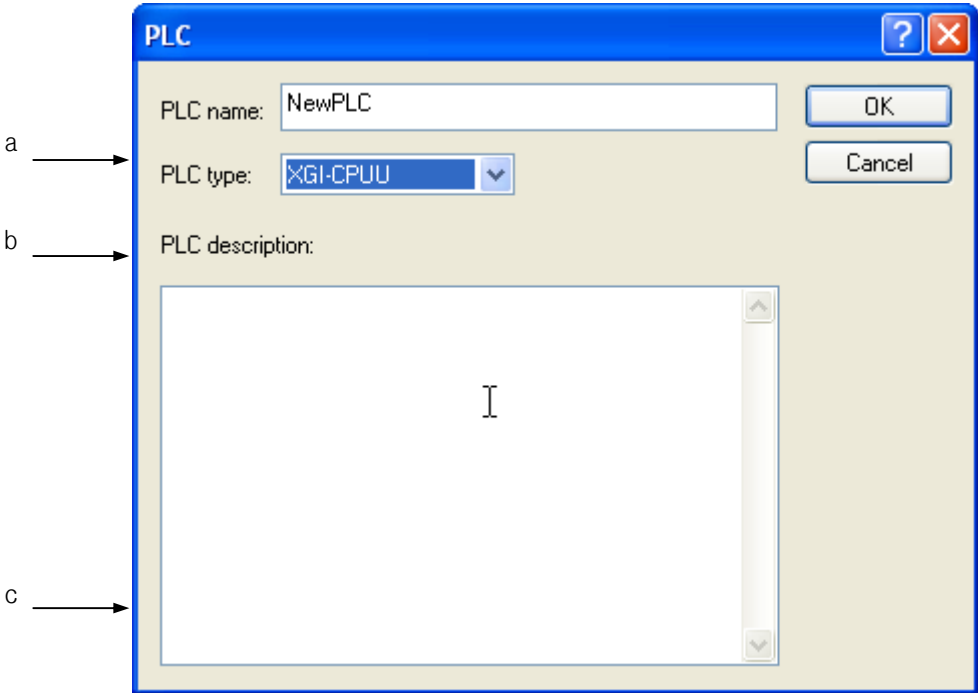

### [Description of Dialog Box]

- a. Project name: displays the project name, which can be changed as necessary.
- b. Project description: displays the project description, which can be changed as necessary.
- c. File Name: displays the file name where the project is saved. Select [Project] - [Save As] to save as a different file.

3. After the change, click [OK].

### 2) PLC Properties

#### [Steps]

1. On the project window, select the PLC Item.
2. Select [View] - [Properties] on the menu.
3. After the change, click [OK].

### 3) Task Properties

#### [Steps]

1. On the project window, select the Task Item.
2. Select [View] - [Properties] on the menu.
3. After the change, click [OK].

### 4) Program Register Information

#### [Steps]

1. On the project window, select the Program Item.
2. Select [View] - [Properties] on the menu.
3. After the change, click [OK].

### 3.4.5 Change program sequence

Scan and Task program will be executed from the upper in regular sequence.

Thus, the program location shall be changed to change the execution sequence.

#### 1) Order Change with the menu

[Steps]

1. Move the cursor onto the program to change the order of execution.
2. Click the right mouse button to select [Move Up (Program)] or [Move Down (Program)] on the menu.

#### 2) Order Change with Drag and Drop

[Steps]

1. Move the cursor onto the program to change the order of execution.
2. Click the left mouse button to drag to the location desired.
3. Drop on the desired location.



### 3.5 Compare Project

Two projects can be compared with each other based on respective item. Compare result will be displayed on the Result window.

[Steps]

1. Select [Project]-[Compare Projects] on the menu.
2. On the [Compare Projects], Click [Open Project].
3. Select the project files to compare with.

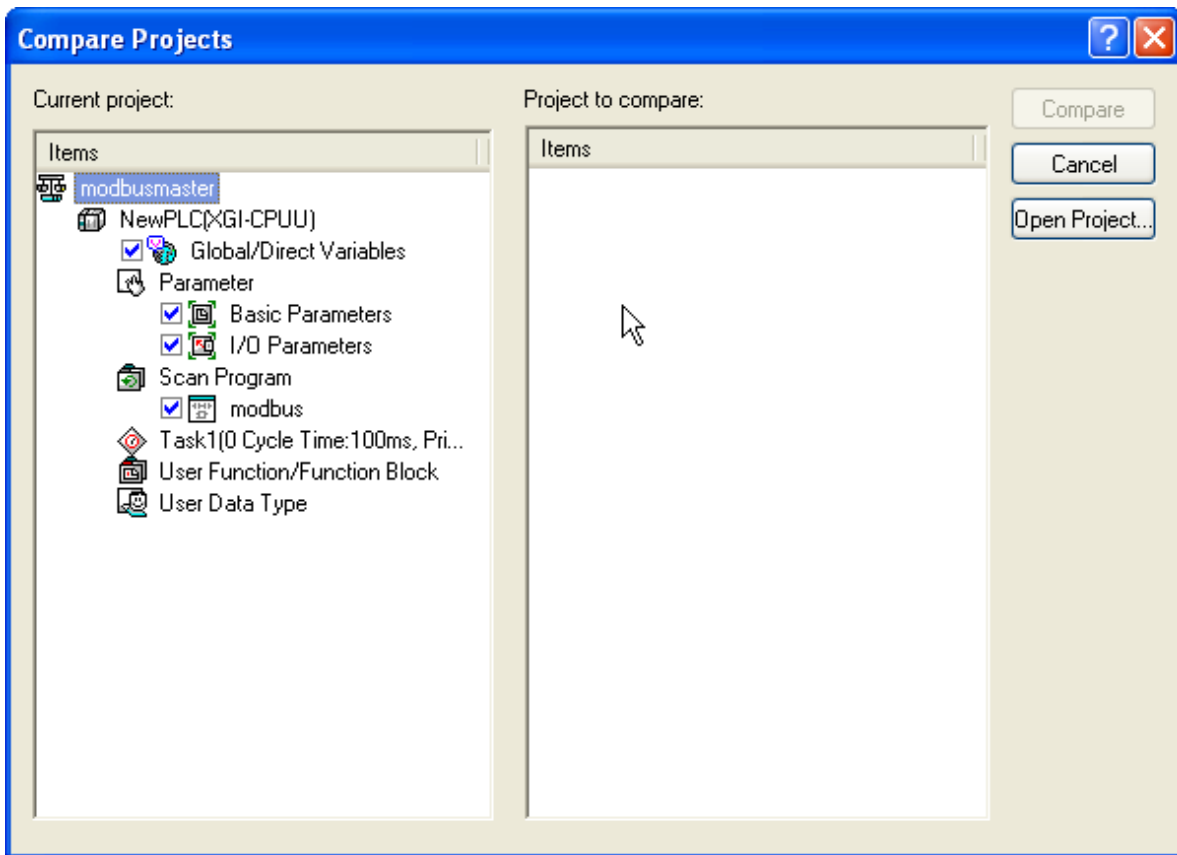

4. Select the items to compare with. At this moment, the selected items of both projects must be identical.

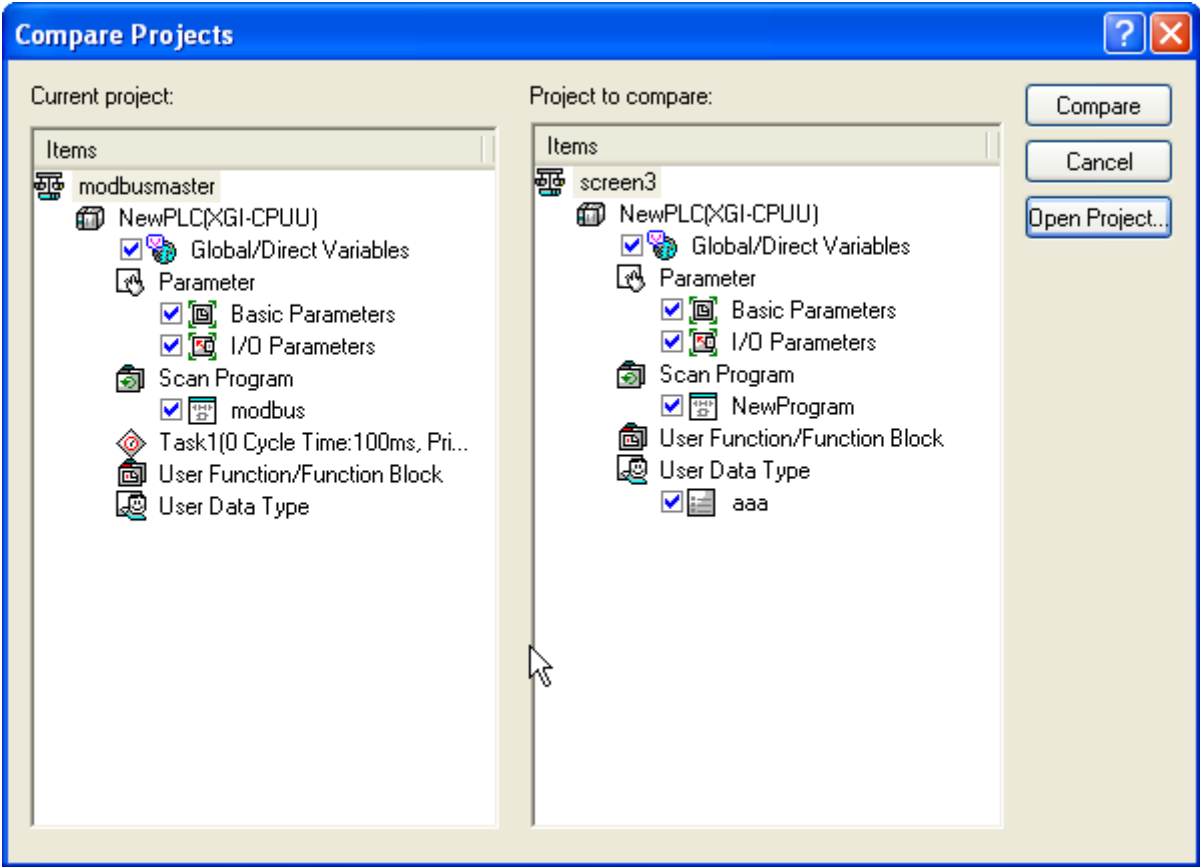

- 5. Click [Compare].
- 6. Compare result will be displayed on the Result window.

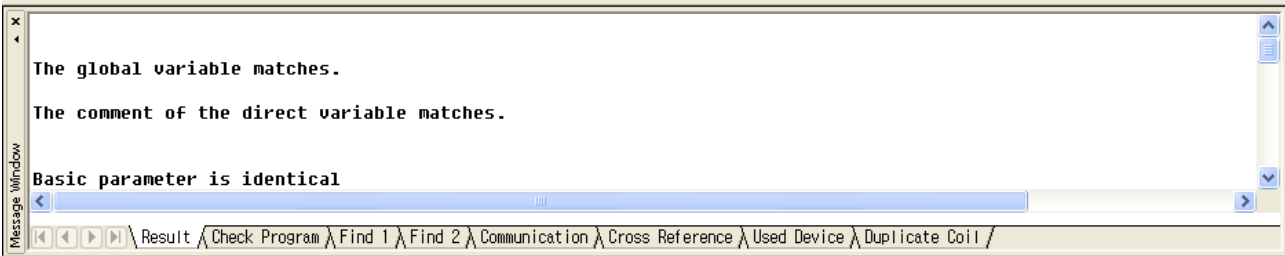

### 3.6 Project Password

Password for project file can be specified. This function prevents other users from opening the project file. This project file password has nothing to do with the password of PLC.

#### Notes

- Password is available in Korean and English, however with the capital/small letters sorted out in English. Up to 8 characters of password is available.
- Be careful! If the password is forgotten, the Project File can not be opened.

#### 3.6.1 Input password

[Steps]

1. On the project window, select the Project Items.

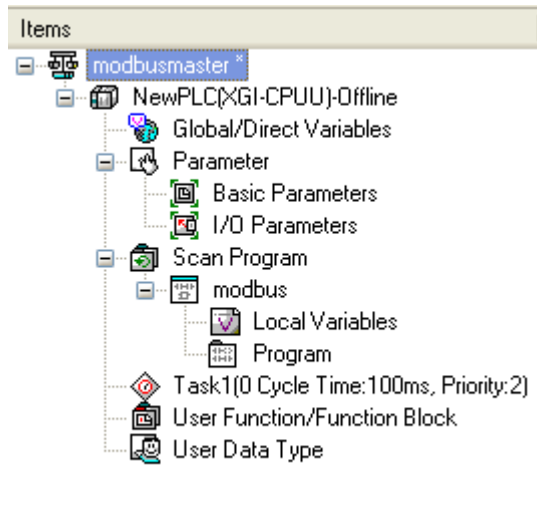

2. Select [View] - [Properties] on the menu.
3. On the project dialog box, select the [Password] tap

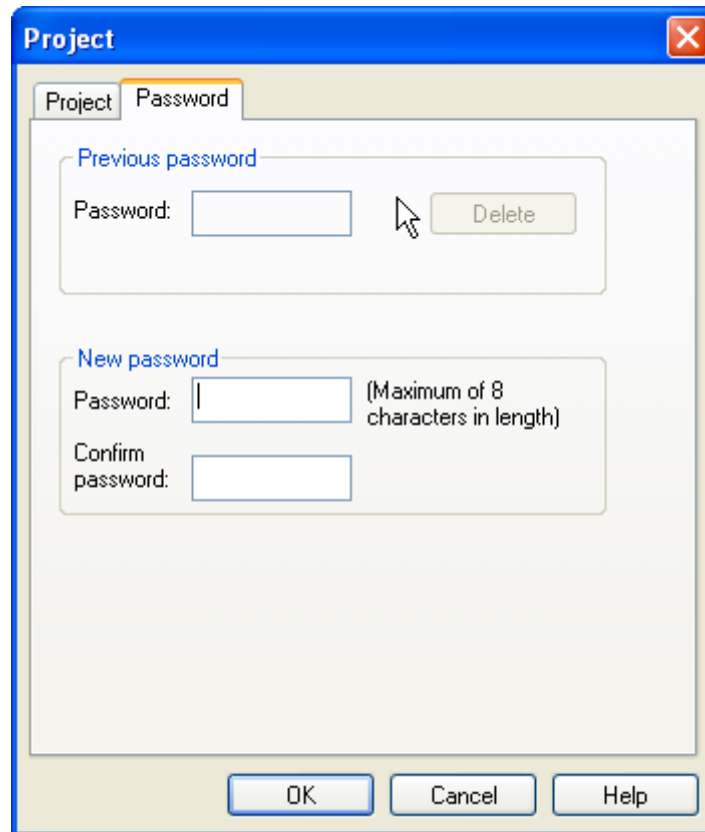

4. Input the password in New password.
5. Input the password once again in Confirm password as identical as input in the above.
6. Click [OK].

### 3.6.2 Change password

[Steps]

1. On the project window, select the Project Item.

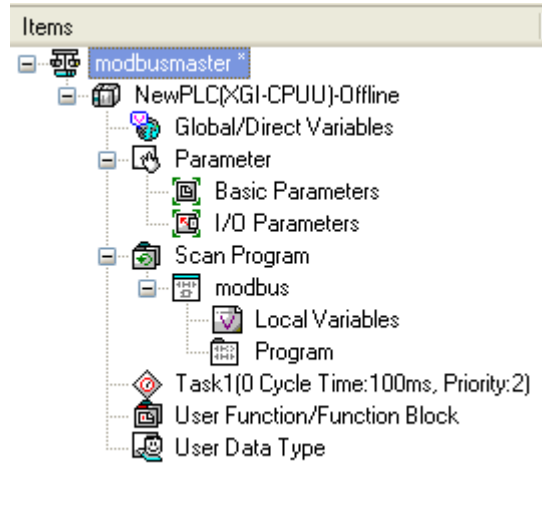

2. Select [View]-[Properties] on the menu.
3. On the project [Dialog Box], select the [Password] tap.

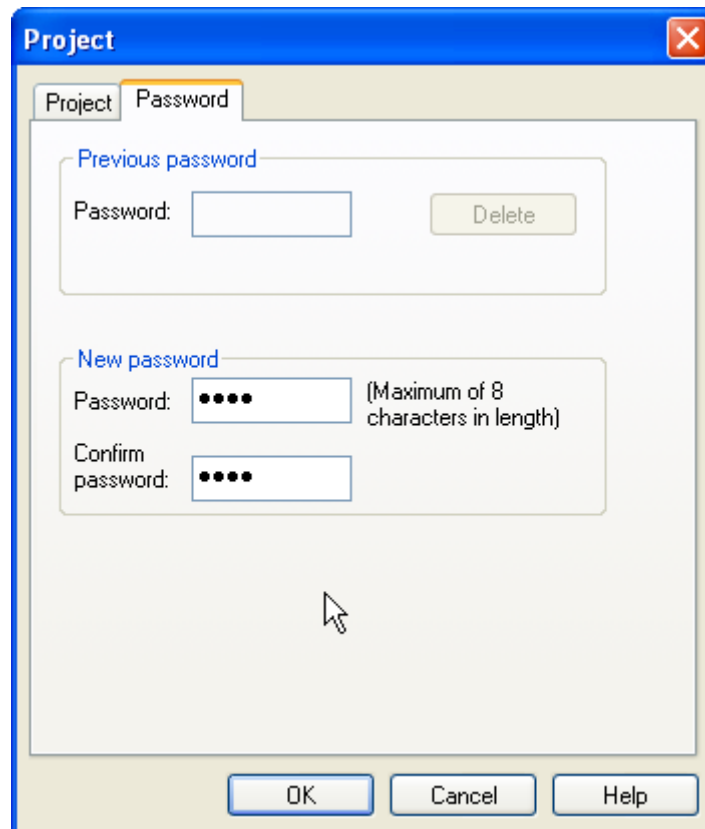

4. Input the previous password in Old Password.
5. Input a new password in New password.
6. Input the new password once again in Confirm Password as identical as input in the 5 above.
7. Click [OK].

### 3.6.3 Delete Password

[Steps]

1. On the project window, select the Project Item.

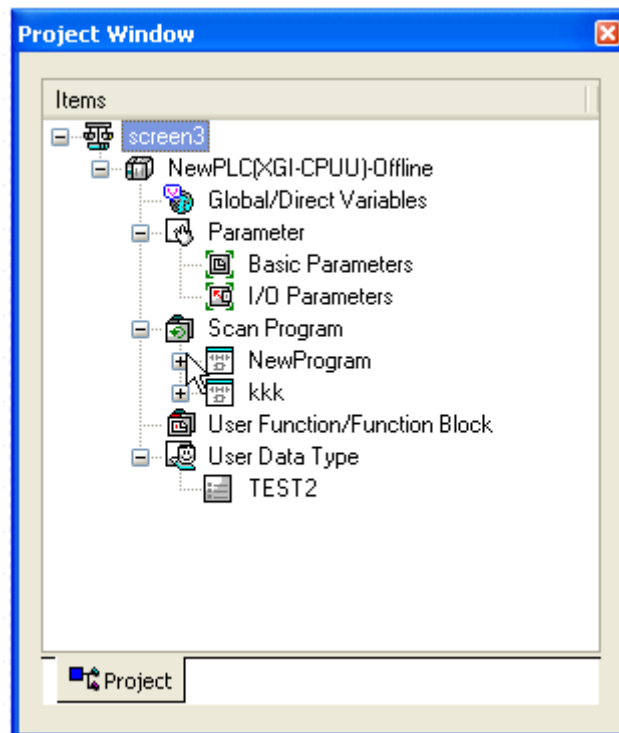

## Chapter 3 Project

2. Select [View] - [Properties] on the menu.
3. On the project dialog box, select the [Password] tap.

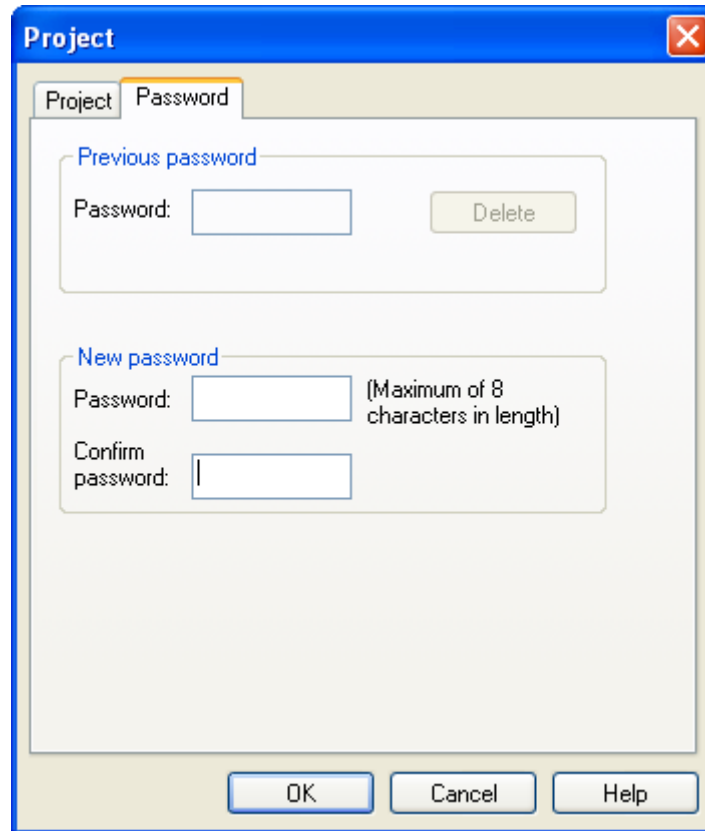

4. Input the previous password in Password.
5. Click [Delete].

# Chapter 4 Variable

A user uses variables depending on a program. In general, global variable is available in every program. To use global variable as local variable, it is necessary to declare it as EXTERNAL before use. Local variable is available only in a designated program. Direct variable can be used in the program. In addition, a comment can be entered to the direct variable.

## 4.1 Global/Direct Variable

Global/Direct variable consist of global variable, direct variable comments and flags. Global variable declares the variable to be used for a program or displays a list of the declared variables, based on the variables. Direct variable comment declares the direct variable comment available in a program or displays the comment. Flag displays a list of flags provided by the declaration. Flag types are divided into system flag, HighSpeed link flag, P2P flag and PID flag.

### 4.1.1 Global Variable

It declares variables and displays a list of the declared global variables.

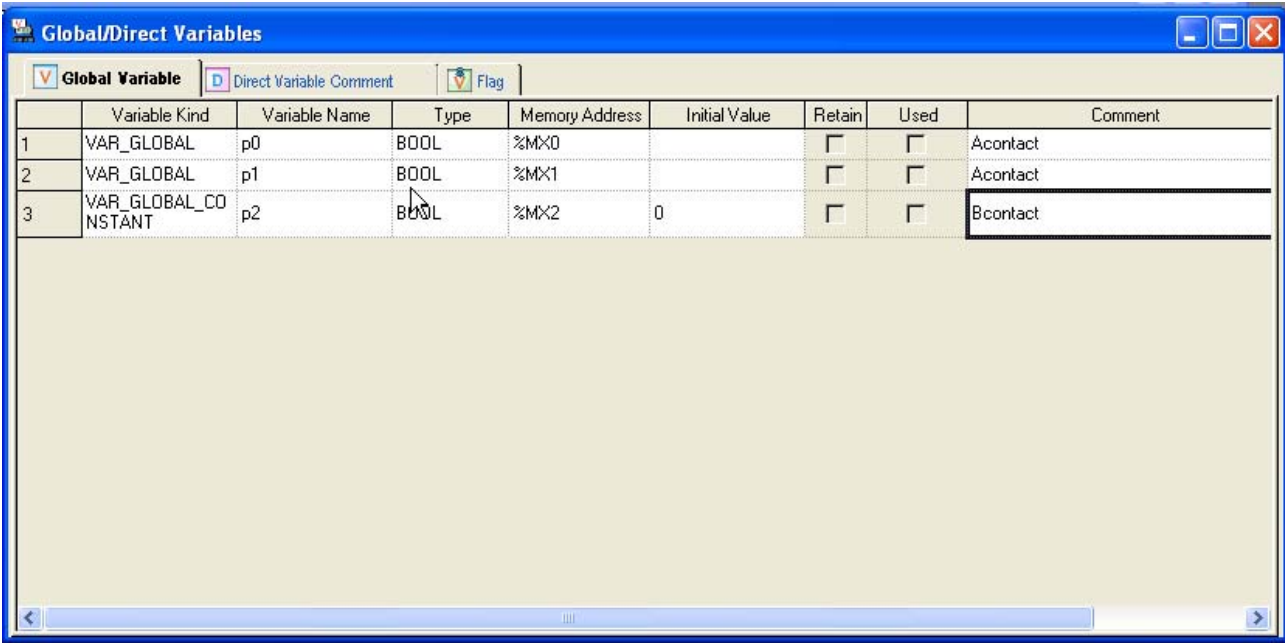

The screenshot shows a software window titled "Global/Direct Variables" with three tabs: "Global Variable", "Direct Variable Comment", and "Flag". The "Global Variable" tab is active, displaying a table with the following data:

	Variable Kind	Variable Name	Type	Memory Address	Initial Value	Retain	Used	Comment
1	VAR_GLOBAL	p0	BOOL	%MX0		<input type="checkbox"/>	<input type="checkbox"/>	Acontact
2	VAR_GLOBAL	p1	BOOL	%MX1		<input type="checkbox"/>	<input type="checkbox"/>	Acontact
3	VAR_GLOBAL_CO NSTANT	p2	BOOL	%MX2	0	<input type="checkbox"/>	<input type="checkbox"/>	Bcontact



## Chapter 4 Variable

### 4.1.2 Direct Variable Comment

It displays the comment of direct variable entered or declared from the variables.

[Dialog Box]

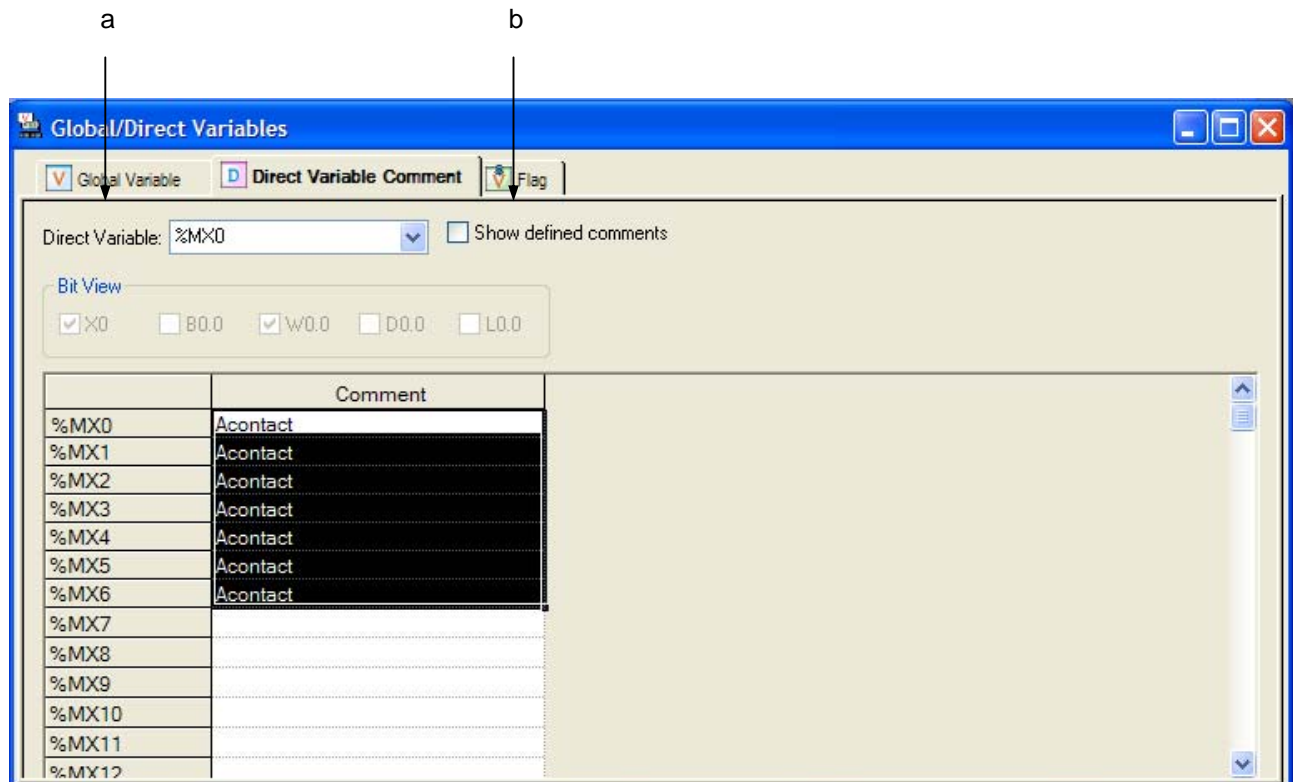

[Description of Dialog Box]

- a. Direct variable: if entering a variable, it displays the data of the direct variable comment.
- b. Show defined comments: displays list of defined comment

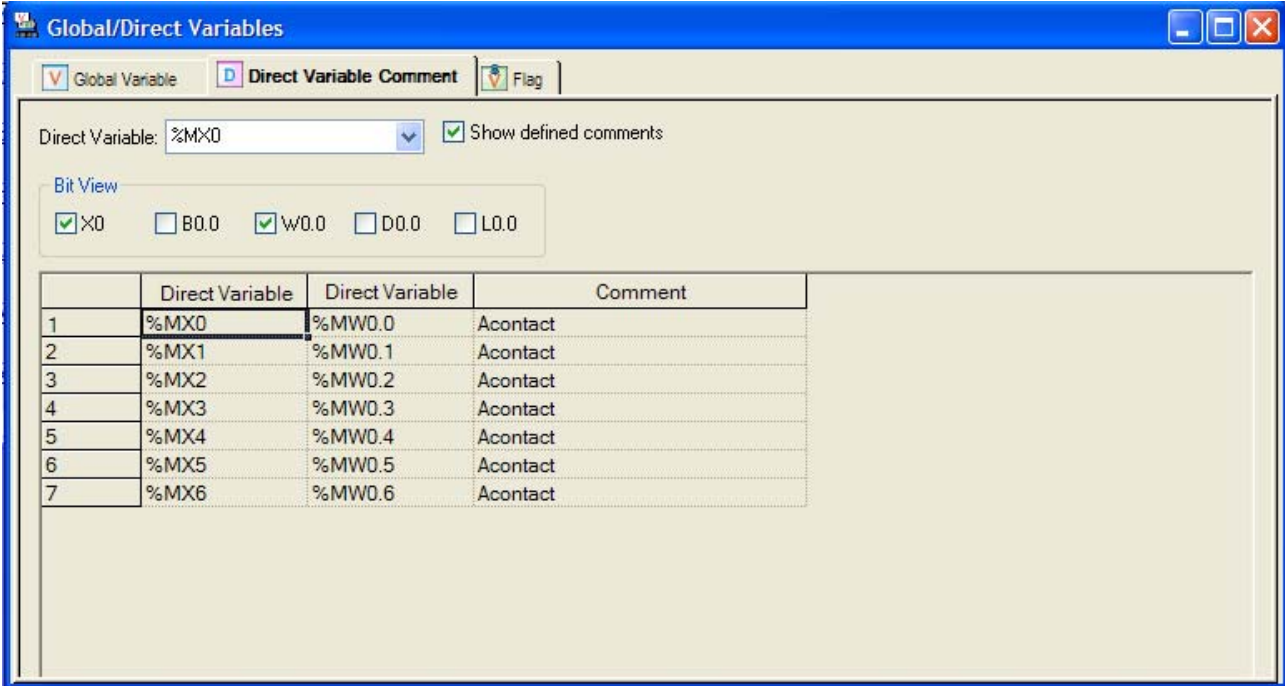

**Notes**

- Direct variable varies depending on CPU type.
- Bit View is activated when 'Show defined comments' is checked.
- At Bit View, more than one button should be checked.

## Chapter 4 Variable

### 4.1.3 Flag

[Dialog Box]

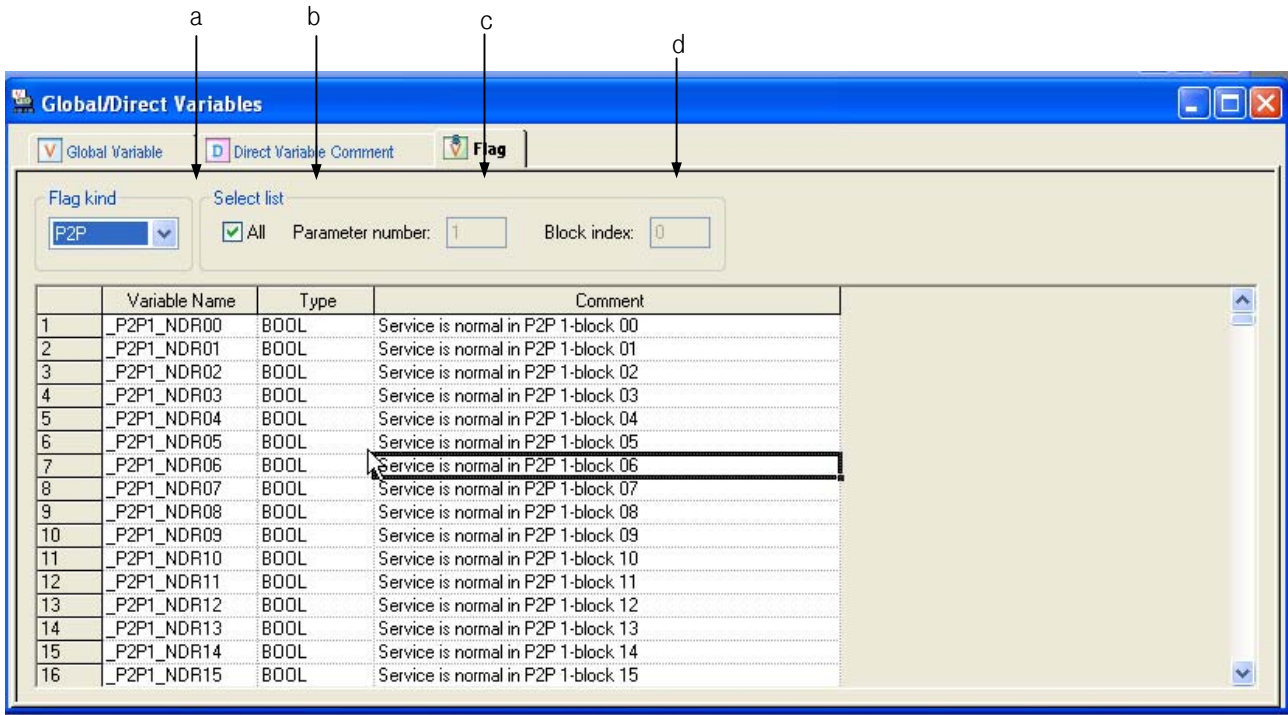

[Description of Dialog Box]

- Flag kind: used to select kind of flag among System, HS link, P2P and PID.
- All: used to display the whole list of the flags selected from [Flag kind]. In case of the system flag, all the details only will be displayed on the screen. If [All] is not checked, only the flag applicable to [Parameter number] and [Block index] will be displayed.
- Parameter number: This will be active only for High-speed link, P2P and PID flag. Only the flag item of the input parameter number will be displayed.  
(Example, If Parameter Number 1 is inputted, it will be as shown below.)

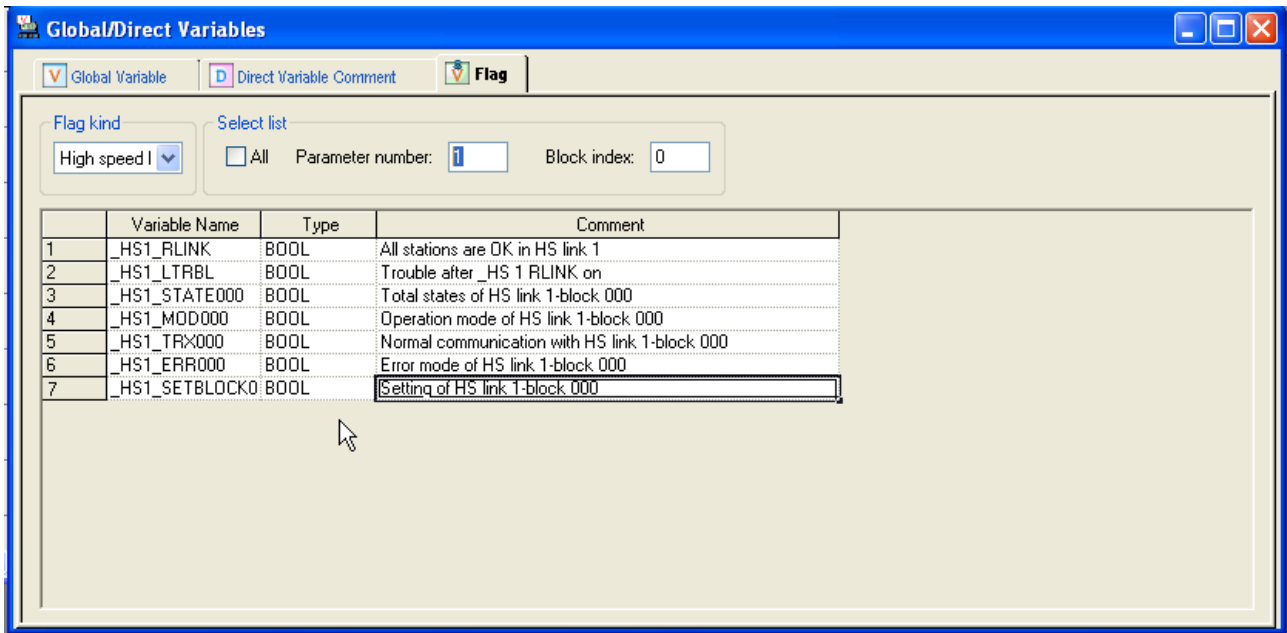

- d. Block index: This will be active only for HighSpeed link and P2P flag. Only the flag item of the input block index will be displayed. (Example, If Block index 120 is inputted, it will be as shown below.)

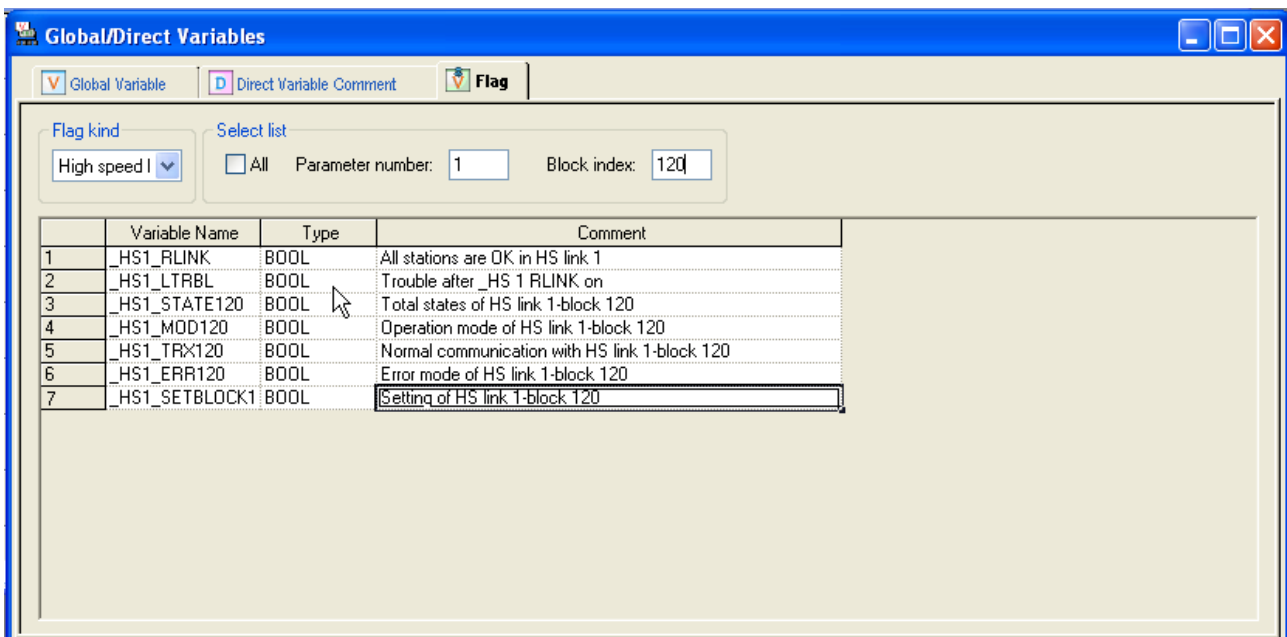

Notes

- Flag can not declare a flag exclusively for Read.

## 4.2 Global/Direct Variable Edit

On the list of the presently declared global/direct variables, variable kind, variable name, memory address, initial value, retain, use or not and comment items can be edited. In addition, a new global variable can be added to the list of the global/direct variables.

### 4.2.1 Global/Direct Variable Registration

This is used to register global/direct variables to use in the program. In order to register on the list of global/direct variables, go through Global Variable.

#### 1) Register in Global Variable

A variable can be added to the list of global variables, modified or deleted from it.

[Dialog Box]

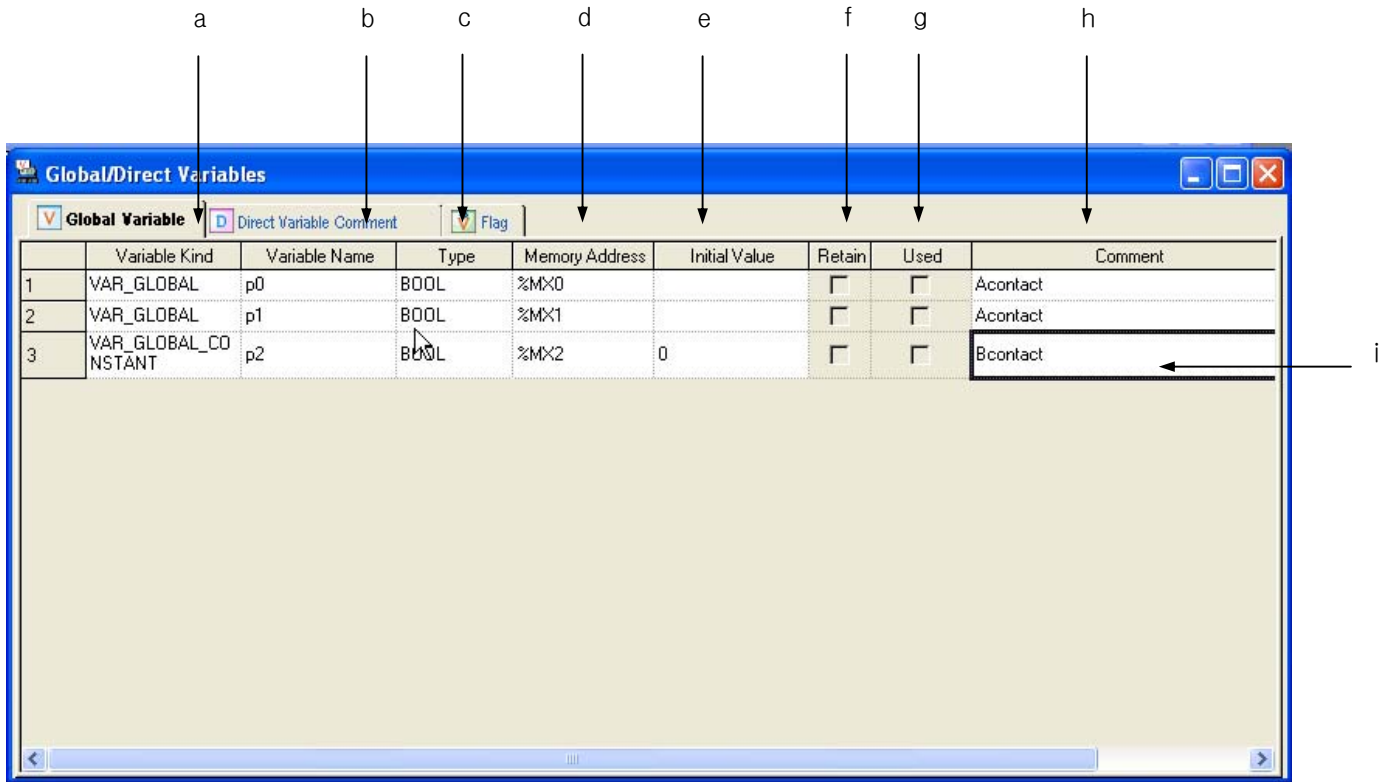

### [Description of Dialog Box]

- a. Variable kind: VAR\_GLOBAL and VAR\_GLOBAL\_CONSTANT are available.
- b. Variable name: The declared variable can not be duplicated with the identical name.
  - A figure is unavailable for the first character.
  - A special character is unavailable. (However, '\_' is available.)
  - Space is not available as a character.
  - A same name with a direct variable is unavailable (i.e. MX0, WB0,...)
  - If a line is empty, BOOL is displayed as the default type when entering a variable.
- c. Type: 23 types are available; 20 basic types and 3 induced types.
  - Basic type (20): (BOOL, BYTE, WORD, DWORD, LWORD, SINT, INT, DINT, LINT, USINT, UINT, UDINT, ULINT, REAL, LREAL, TIME, DATE, TIME\_OF\_DAY, DATE\_AND\_TIME, STRING)
  - Induced type (3): ARRAY(i.e. ARRAY[0..6,0..2,0..4] OF BOOL) => factor limit (up to 3rd), STRUCT(i.e. STRUCT name display) => STRUCT type is not available in STRUCT, FB\_INST (i.e. FB name display)
- d. Memory address: enters it by using direct variable (I, Q, M, R, W).
- e. Initial value: default value can be set.
- f. Retain: if memory address is set, retain column is inactive.
  - R, W: always retain area.
  - M: check it by obtaining basic parameter information.
  - I, Q: always not retain area.
- g. Used: display whether to use a declared variable.
- h. Comment: every character is available.
  - Multi line entry is available by using Ctrl + Enter key.
- i. Line validity: To register on global variable window, it needs variable type, variable and type.
  - If not registered on global variable, it is displayed in pink.

### Notes

- If any error occurs when editing a cell, it is displayed in pink.
- Press ESC key to recover the previous value during the cell edit

### 4.2.2 Copy, Cut, Delete and Paste

Copy, cut, delete or paste can be executed to edit the list of global/direct variables used in the program.

#### 1) Copy

It is used to save the data of the area selected to copy in the clipboard. The copied details can be added to the present project or other projects. Paste on other applications is also available

[Steps]

1. Select the area to copy.
2. Select [Edit] - [Copy] on the menu.

#### Notes

- How to select the area is as follows;
- Use the mouse to select the cell of (0,0) in order to select the whole table
- Select [Edit] - [Select All] in order to select the whole table.
- Use the mouse to select the column header of the cell in order to select the whole columns.
- Use the mouse to select the row header of the cell in order to select the whole rows.
- Use the mouse to drag the part of the cell in order to select the area.
- Use Shift + Arrow keys on the keyboard in order to select the area.

#### 2) Delete

It is used to delete the data of the selected area from the list of global/direct variables.

[Steps]

1. Select the area to delete.
2. Select [Edit] - [Delete] on the menu

#### Notes

- Flag can not be edited exclusively for Read.

3) Cut

It is used to save the selected data in the clipboard in order to add to the present project or other projects. Besides, it will delete the selected data.

[Steps]

1. Select the area to cut.
2. Select [Edit]-[Cut] on the menu.

4) Paste

It displays the data saved in the clipboard on the selected position. If the data is already displayed, the Dialog Box will be called to select and change the data.

\* If the data saved in the clipboard is a part of columns,

[Steps]

1. Select the position to paste on.
2. Select [Edit]-[Paste] on the menu.
3. If the variable and direct variable are identical on the list of variables/comments, the dialog box will be called.

[Dialog Box]

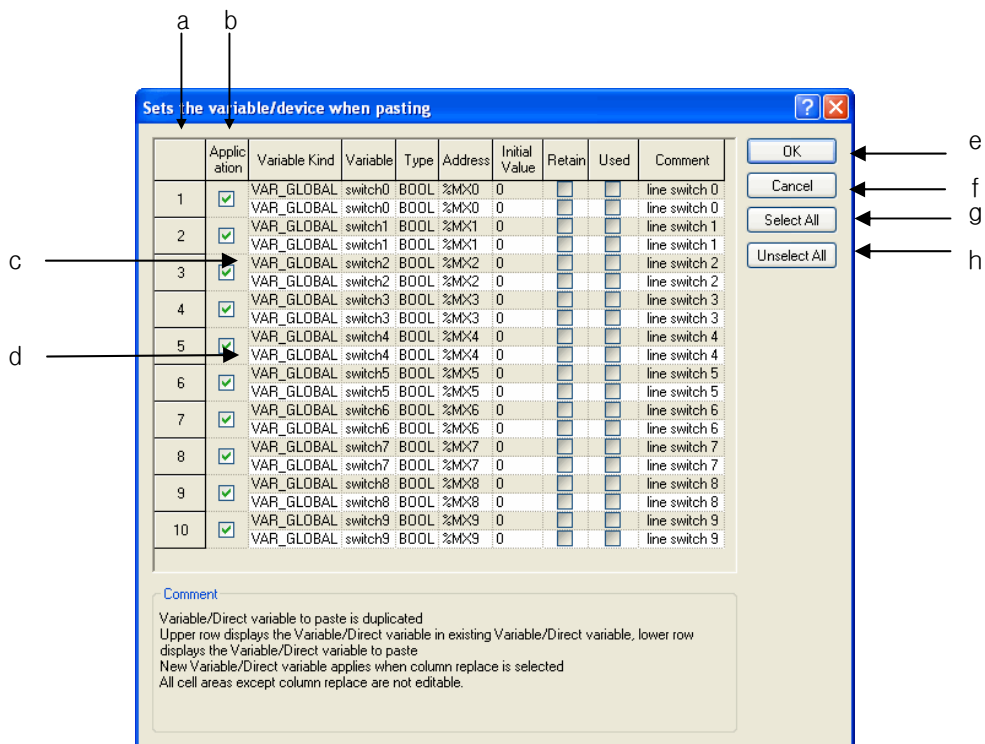



## Chapter 4 Variable

### [Description of Dialog Box]

- Number: used to display the duplicated number of the variables and direct variables to paste
- Replace: used to apply Paste.
- Gray Line: used to display the existing list of variables/comments, which will not be edited.
- White Line: used to display the list of variables/comments obtained from the clipboard, which will not be edited.
- OK: applies the lines of the selected check box. The existing list of variables/comments will be deleted to add a new list of variables/comments.
- Cancel: The existing list of variables/comments will not be deleted, and a new the list of variables/comments will not be applied accordingly.
- Select All: used to check all the check boxes in the [Replace] column.
- Unselect All: used to cancel all the selected check boxes in the [Replace] column.

\* If the data saved in the clipboard is of the partial column,

### [Steps]

- Select the position to paste on.
- Select [Edit] – [Paste] on the menu.
- If the variable and direct variable are identical on the list of variables/comments, the dialog box will be called.

### [Dialog Box]

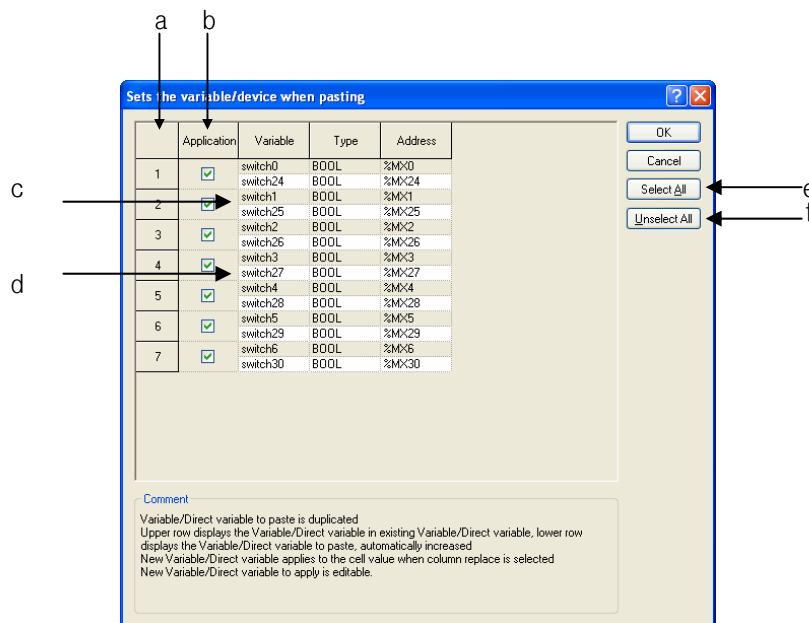

[Comment of Dialog Box]

- a. Number: used to display the duplicated number of the variables and direct variables to paste
- b. Replace: used to apply Paste.
- c. Gray Line: used to display the data in the existing cell, which will not be edited.
- d. White Line: If the variable or device of the data to paste is duplicated, it will be automatically increased and then displayed on the screen. In addition, the cell can be edited.
- e. Select All: used to check all the check boxes in the [Replace] column.
- f. Unselect All: used to cancel all the selected check boxes in the [Replace] column.

### Notes

- If all items are identical, the cell can not be edited, while if partially identical, the cell can be edited.
- If the number of the columns saved in the clipboard is greater than the number of the columns to paste, it is not possible to paste.
- If the data saved in the clipboard is greater than the number of the lines to paste, it is not possible to paste.
- Paste in View Direct Variable Comment will regard the data saved in the clipboard as the partial columns.
- Paste is not available in Flag but in other Excel program.

### 4.2.3 Insert line

It is used to insert new lines as many as the lines of the selected area, which will make the existing lines move downward.

[Steps]

1. Select the area to insert the lines into.
2. Select [Edit] - [Insert Line] on the menu.

## Chapter 4 Variable

Global/Direct Variables

Global Variable | Direct Variable Comment | Flag

	Variable Kind	Variable Name	Type	Memory Address	Initial Value	Retain	Used	Comment
1	VAR_GLOBAL	p0	BOOL	%MX0		<input type="checkbox"/>	<input type="checkbox"/>	
2	VAR_GLOBAL	p1	BOOL	%MX1		<input type="checkbox"/>	<input type="checkbox"/>	
3	VAR_GLOBAL_CO	p2	BOOL	%MX2	0	<input type="checkbox"/>	<input type="checkbox"/>	
4						<input type="checkbox"/>	<input type="checkbox"/>	
5						<input type="checkbox"/>	<input type="checkbox"/>	
6						<input type="checkbox"/>	<input type="checkbox"/>	
7						<input type="checkbox"/>	<input type="checkbox"/>	
8						<input type="checkbox"/>	<input type="checkbox"/>	
9						<input type="checkbox"/>	<input type="checkbox"/>	
10						<input type="checkbox"/>	<input type="checkbox"/>	

Global/Direct Variables

Global Variable | Direct Variable Comment | Flag

	Variable Kind	Variable Name	Type	Memory Address	Initial Value	Retain	Used	Comment
1	VAR_GLOBAL	p0	BOOL	%MX0		<input type="checkbox"/>	<input type="checkbox"/>	
2						<input type="checkbox"/>	<input type="checkbox"/>	
3	VAR_GLOBAL	p1	BOOL	%MX1		<input type="checkbox"/>	<input type="checkbox"/>	
4	VAR_GLOBAL_CO	p2	BOOL	%MX2	0	<input type="checkbox"/>	<input type="checkbox"/>	
5						<input type="checkbox"/>	<input type="checkbox"/>	
6						<input type="checkbox"/>	<input type="checkbox"/>	
7						<input type="checkbox"/>	<input type="checkbox"/>	
8						<input type="checkbox"/>	<input type="checkbox"/>	
9						<input type="checkbox"/>	<input type="checkbox"/>	
10						<input type="checkbox"/>	<input type="checkbox"/>	
11						<input type="checkbox"/>	<input type="checkbox"/>	

### Notes

- If no cell is selected, one line will be added to the first line
- If Enter key or Tab key is selected at the last of the lines, a new line will be created
- It is available only in Global Variable.

### 4.2.4 Delete line

It is used to delete the lines as many as the lines of the selected area.

[Steps]

1. Select the area to delete the lines from.
2. Select [Edit] - [Delete Line] on the menu.

The screenshot shows the 'Global/Direct Variables' dialog box with the 'Global Variable' tab selected. The table contains the following data:

	Variable Kind	Variable Name	Type	Memory Address	Initial Value	Retain	Used	Comment
1	VAR_GLOBAL	p0	BOOL	%MX0		<input type="checkbox"/>	<input type="checkbox"/>	
2						<input type="checkbox"/>	<input type="checkbox"/>	
3	VAR_GLOBAL	p1	BOOL	%MX1		<input type="checkbox"/>	<input type="checkbox"/>	
4	VAR_GLOBAL_CO	p2	BOOL	%MX2	0	<input type="checkbox"/>	<input type="checkbox"/>	
5						<input type="checkbox"/>	<input type="checkbox"/>	
6						<input type="checkbox"/>	<input type="checkbox"/>	
7						<input type="checkbox"/>	<input type="checkbox"/>	
8						<input type="checkbox"/>	<input type="checkbox"/>	
9						<input type="checkbox"/>	<input type="checkbox"/>	
10						<input type="checkbox"/>	<input type="checkbox"/>	
11						<input type="checkbox"/>	<input type="checkbox"/>	

The screenshot shows the 'Global/Direct Variables' dialog box after deleting row 3. The table contains the following data:

	Variable Kind	Variable Name	Type	Memory Address	Initial Value	Retain	Used	Comment
1	VAR_GLOBAL	p0	BOOL	%MX0		<input type="checkbox"/>	<input type="checkbox"/>	
2	VAR_GLOBAL	p1	BOOL	%MX1		<input type="checkbox"/>	<input type="checkbox"/>	
3	VAR_GLOBAL_CO	p2	BOOL	%MX2	0	<input type="checkbox"/>	<input type="checkbox"/>	
4						<input type="checkbox"/>	<input type="checkbox"/>	
5						<input type="checkbox"/>	<input type="checkbox"/>	
6						<input type="checkbox"/>	<input type="checkbox"/>	
7						<input type="checkbox"/>	<input type="checkbox"/>	
8						<input type="checkbox"/>	<input type="checkbox"/>	
9						<input type="checkbox"/>	<input type="checkbox"/>	
10						<input type="checkbox"/>	<input type="checkbox"/>	

## Chapter 4 Variable

### Notes

- If no cell is selected, [Delete Line] will not be executed.
- It is available only in Global Variable.

### 4.2.5 Automatic fill

It is used to increase or decrease variables and direct variables to add on the list of variables/comments.

[Steps]

1. Move the mouse to the end of the cell and the mouse cursor will change to + shape.
2. Move the mouse upward and downward with its left button being pressed.

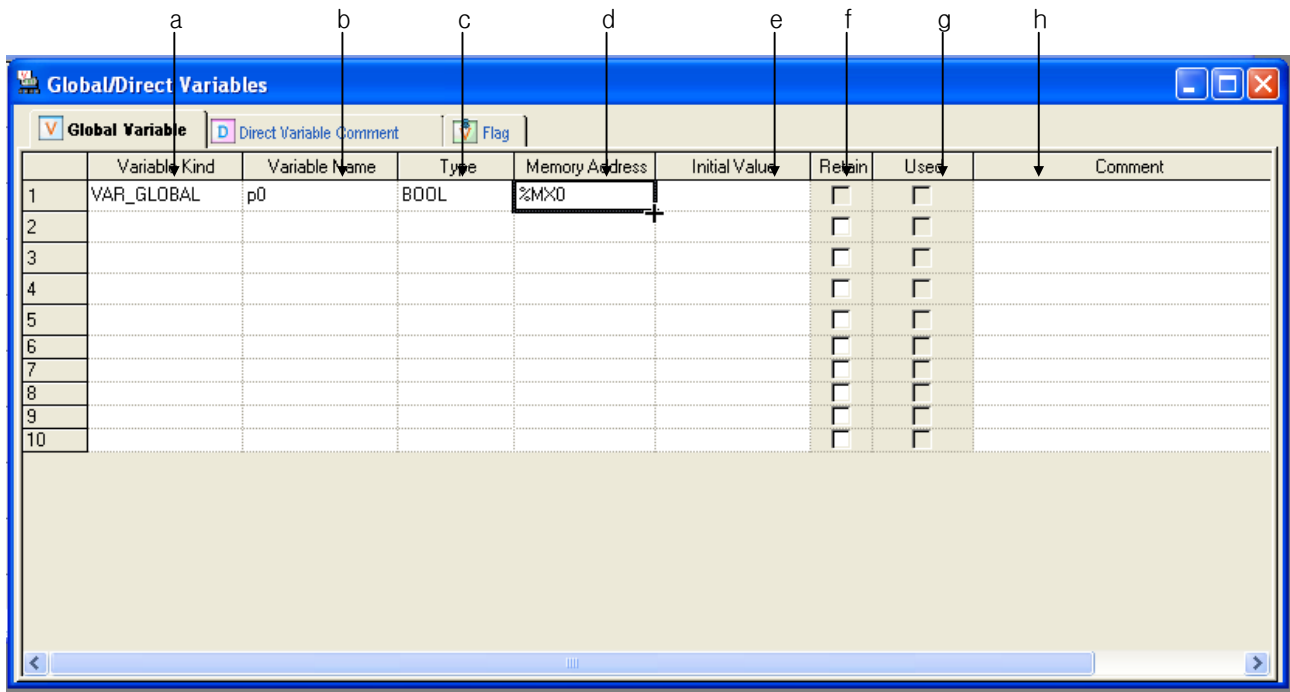

## Chapter 4 Variable

	Variable Kind	Variable Name	Type	Memory Address	Initial Value	Retain	Used	Comment
1	VAR_GLOBAL	p0	BOOL	%Mx0		<input type="checkbox"/>	<input type="checkbox"/>	
2						<input type="checkbox"/>	<input type="checkbox"/>	
3						<input type="checkbox"/>	<input type="checkbox"/>	
4						<input type="checkbox"/>	<input type="checkbox"/>	
5						<input type="checkbox"/>	<input type="checkbox"/>	
6						<input type="checkbox"/>	<input type="checkbox"/>	
7						<input type="checkbox"/>	<input type="checkbox"/>	
8						<input type="checkbox"/>	<input type="checkbox"/>	
9						<input type="checkbox"/>	<input type="checkbox"/>	
10						<input type="checkbox"/>	<input type="checkbox"/>	

	Variable Kind	Variable Name	Type	Memory Address	Initial Value	Retain	Used	Comment
1	VAR_GLOBAL	p0	BOOL	%Mx0		<input type="checkbox"/>	<input type="checkbox"/>	
2				%Mx1		<input type="checkbox"/>	<input type="checkbox"/>	
3				%Mx2		<input type="checkbox"/>	<input type="checkbox"/>	
4				%Mx3		<input type="checkbox"/>	<input type="checkbox"/>	
5				%Mx4		<input type="checkbox"/>	<input type="checkbox"/>	
6						<input type="checkbox"/>	<input type="checkbox"/>	
7						<input type="checkbox"/>	<input type="checkbox"/>	
8						<input type="checkbox"/>	<input type="checkbox"/>	
9						<input type="checkbox"/>	<input type="checkbox"/>	
10						<input type="checkbox"/>	<input type="checkbox"/>	

## Chapter 4 Variable

[Details]

- a. Variable kind: the value is filled in a cell as copied.
- b. Variable Name: it always executes Automatic Fill because a variable can not be declared in duplicate. If it contains a number, it automatically increases. If not, it adds a number at the end and counts it automatically.
- c. Type: it is filled in a cell as copied.
- d. Memory address: it always executes Automatic Fill because memory allocation can not be declared in duplicate. If it contains a number, it searches for the part and increases it automatically.
- e. Initial value: it is filled in a cell as copied.
- f. Retain: it is checked as copied.
- g. Used: it can not be modified because of Read Only.
- h. Comment: If Automatic Fill is executed with Ctrl key being pressed, the figures area will automatically increase, and if with Ctrl key not pressed, it will be copied.

### Notes

- If Automatic Fill is executed with an empty cell, it will be deleted
- Automatic Fill is available for many cells
- It is available only in global variable and direct variable comments.

### 4.2.6 Drag & Drop

It is used to copy the selected items to paste on different positions.

[Steps]

1. Select the area to drag and drop.
2. The mouse cursor will change to the state available for drag and drop.
3. With the left mouse button being pressed, drag and drop the selected items onto a position to paste on

## Chapter 4 Variable

Global/Direct Variables

Global Variable | Direct Variable Comment | Flag

	Variable Kind	Variable Name	Type	Memory Address	Initial Value	Retain	Used	Comment
1	VAR_GLOBAL	p0	BOOL	%MX0		<input type="checkbox"/>	<input type="checkbox"/>	
2	VAR_GLOBAL	p1	BOOL	%MX1		<input type="checkbox"/>	<input type="checkbox"/>	
3	VAR_GLOBAL	p2	BOOL	%MX2		<input type="checkbox"/>	<input type="checkbox"/>	
4	VAR_GLOBAL	p3	BOOL	%MX3		<input type="checkbox"/>	<input type="checkbox"/>	
5	VAR_GLOBAL	p4	BOOL	%MX4		<input type="checkbox"/>	<input type="checkbox"/>	
6						<input type="checkbox"/>	<input type="checkbox"/>	
7						<input type="checkbox"/>	<input type="checkbox"/>	
8						<input type="checkbox"/>	<input type="checkbox"/>	
9						<input type="checkbox"/>	<input type="checkbox"/>	
10						<input type="checkbox"/>	<input type="checkbox"/>	

Global/Direct Variables

Global Variable | Direct Variable Comment | Flag

	Variable Kind	Variable Name	Type	Memory Address	Initial Value	Retain	Used	Comment
1	VAR_GLOBAL	p0	BOOL	%MX0		<input type="checkbox"/>	<input type="checkbox"/>	
2	VAR_GLOBAL	p1	BOOL	%MX1		<input type="checkbox"/>	<input type="checkbox"/>	
3	VAR_GLOBAL	p2	BOOL	%MX2		<input type="checkbox"/>	<input type="checkbox"/>	
4	VAR_GLOBAL	p3	BOOL	%MX3		<input type="checkbox"/>	<input type="checkbox"/>	
5	VAR_GLOBAL	p4	BOOL	%MX4		<input type="checkbox"/>	<input type="checkbox"/>	
6						<input type="checkbox"/>	<input type="checkbox"/>	
7						<input type="checkbox"/>	<input type="checkbox"/>	
8						<input type="checkbox"/>	<input type="checkbox"/>	
9						<input type="checkbox"/>	<input type="checkbox"/>	
10						<input type="checkbox"/>	<input type="checkbox"/>	



## Chapter 4 Variable

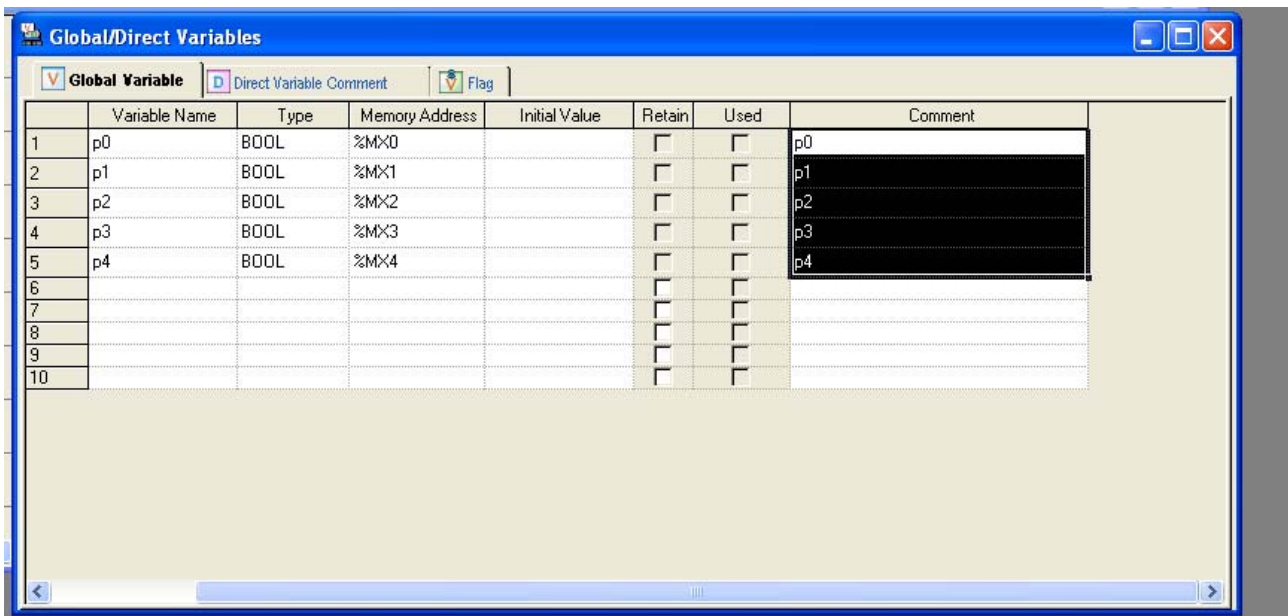

[Details]

- Drag and drop is available onto Variable Monitoring Window.
- Drag and drop is available onto LD Window.
- Copy is available when drag and drop is executed onto Excel program.
- Drag and drop is available onto Data Traces window.
- Drag and drop is available onto Global Variable of other XG5000 programs.
- Drag and drop is available onto Direct Variable Comment of other XG5000 programs.

### Notes

- Data is not moved but just copied always when dragged and dropped
- Paste is not available in Flag

### 4.2.7 Undo/Redo

Undo is used to cancel the edited detail in order to return to its previous state. Redo cancels again the operation of Edit Cancel.

[Details]

- Undo/Redo is available for Cell Edit.
- Undo/Redo is available for Change.
- Undo/Redo is available for All Change.
- Undo/Redo is available for Delete.
- Undo/Redo is available for Cut.
- Undo/Redo is available for Paste.

7. Undo/Redo is available for Automatic Fill.
8. Undo/Redo is available for Insert Line. (Only in Global Variable)
9. Undo/Redo is available for Delete Line. (Only in Global Variable)
10. Undo/Redo is available for drag and drop.
11. Undo/Redo is available for Align. (Only in Global Variable)

### Notes

- In Global Variable, if the data is moved to other windows or a variable is added in LD and IL, all the information for Undo/Redo will disappear.
- In Direct Variable Comment, if the direct variable item changes, all the information for Undo/Redo will disappear.
- It is not used in Flag.

### 4.2.8 Export to file

It is used to save the previously declared list of global variables on the file and to open and read in the external programs.

[Steps]

1. Select [Edit] - [Export to File] on the menu.

### Notes

- It is available only in Global Variable.

## Chapter 4 Variable

### 4.2.9 Register Special Module Variables

It is used to register variables of the respective module by referring to the special module information specified in I/O parameter. The user can modify the variable and the comment.

[Steps]

1. Set the special module on the slot in I/O parameter.

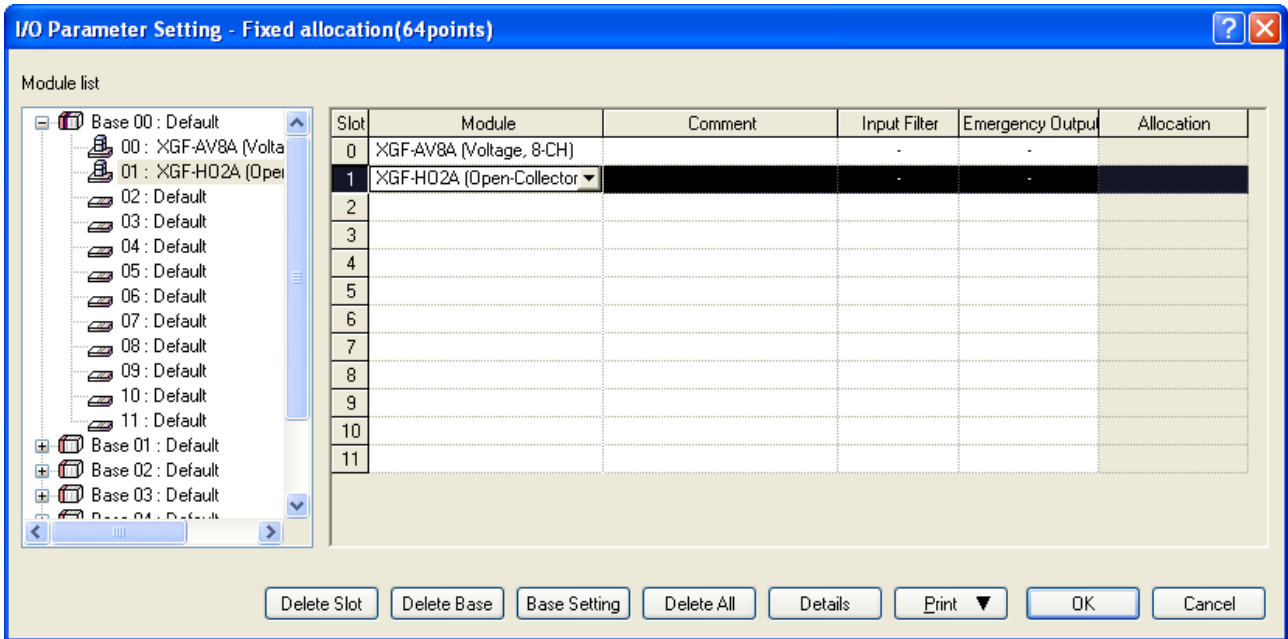

2. Select [Global Variable/Direct Variable] in the project window.
3. Select [Global Variable] tap in the Global/Direct Variable window.

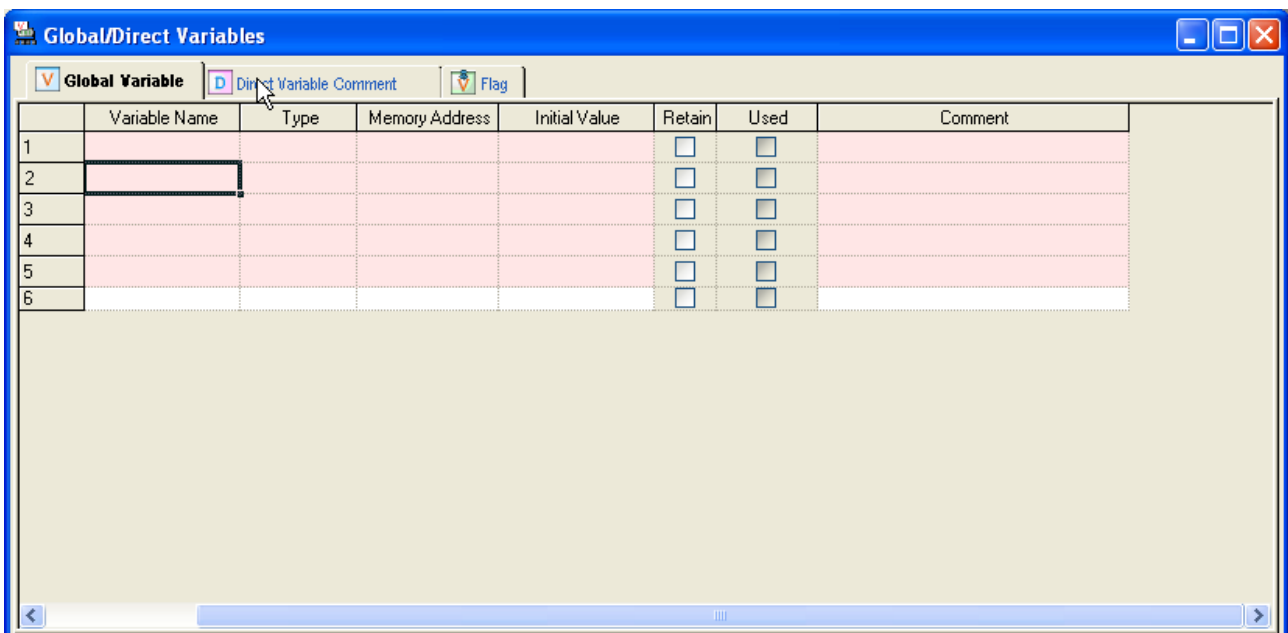

4. Select [Edit]-[Register Special Module Variables] on the menu.



	Variable Name	Type	Memory Address	Initial Value	Retain	Used	Comment
19	_00_CH6_ACT	BOOL			<input type="checkbox"/>	<input type="checkbox"/>	Analog Input Module: CH6 Active
20	_00_CH6_DATA	INT			<input type="checkbox"/>	<input type="checkbox"/>	Analog Input Module: CH6 Output
21	_00_CH6_IDD	BOOL			<input type="checkbox"/>	<input type="checkbox"/>	Analog Input Module: CH6 Input Disconn
22	_00_CH7_ACT	BOOL			<input type="checkbox"/>	<input type="checkbox"/>	Analog Input Module: CH7 Active
23	_00_CH7_DATA	INT			<input type="checkbox"/>	<input type="checkbox"/>	Analog Input Module: CH7 Output
24	_00_CH7_IDD	BOOL			<input type="checkbox"/>	<input type="checkbox"/>	Analog Input Module: CH7 Input Disconn
25	_00_ERR	BOOL			<input type="checkbox"/>	<input type="checkbox"/>	Analog Input Module: Module Error
26	_00_ERR_CLR	BOOL			<input type="checkbox"/>	<input type="checkbox"/>	Analog Input Module: Error Clear Request
27	_00_RDY	BOOL			<input type="checkbox"/>	<input type="checkbox"/>	Analog Input Module: Module Ready
28	_01_CH0_AUXEN	BOOL			<input type="checkbox"/>	<input type="checkbox"/>	HSC Module: CH0 Auxiliary Function Ena
29	_01_CH0_AUXING	BOOL			<input type="checkbox"/>	<input type="checkbox"/>	HSC Module: CH0 Auxiliary Function Flag
30	_01_CH0_BRW	BOOL			<input type="checkbox"/>	<input type="checkbox"/>	HSC Module: CH0 Borrow
31	_01_CH0_CMPEN	BOOL			<input type="checkbox"/>	<input type="checkbox"/>	HSC Module: CH0 Count Comparison Fun
32	_01_CH0_CMPOUT	BOOL			<input type="checkbox"/>	<input type="checkbox"/>	HSC Module: CH0 Comparator Output0 0
33	_01_CH0_CMPOUT	BOOL			<input type="checkbox"/>	<input type="checkbox"/>	HSC Module: CH0 Comparator Output1 0
34	_01_CH0_CNT	DWORD			<input type="checkbox"/>	<input type="checkbox"/>	HSC Module: CH0 Current Count
35	_01_CH0_CNTEN	BOOL			<input type="checkbox"/>	<input type="checkbox"/>	HSC Module: CH0 Counter Enable(Level)
36	_01_CH0_CRTBR	BOOL			<input type="checkbox"/>	<input type="checkbox"/>	HSC Module: CH0 Carry/Borrow Reset(E
37	_01_CH0_CRY	BOOL			<input type="checkbox"/>	<input type="checkbox"/>	HSC Module: CH0 Carry
38	_01_CH0_DN	BOOL			<input type="checkbox"/>	<input type="checkbox"/>	HSC Module: CH0 Count Inc/Dec Flag

Notes

- Deletes all the existing information of the Global variable to add on the list of variables/comments referring to the presently specified I/O parameter.

## Chapter 4 Variable

### 4.2.10 Preview

This function is used to previously show the screen which will be printed.

[Steps]

1. The window to previously show shall be displayed on the screen.
2. Select [Project]-[Preview] on the menu.

	Variable Kind	Variable	Type	Address	Initial Value	Retain	Used	Comment
1	VAR_GLOBAL	switch0	BOOL	%MX0	0	<input type="checkbox"/>	<input type="checkbox"/>	line switch 0
2	VAR_GLOBAL	switch1	BOOL	%MX1	0	<input type="checkbox"/>	<input type="checkbox"/>	line switch 1
3	VAR_GLOBAL	switch10	BOOL	%MX10	0	<input type="checkbox"/>	<input type="checkbox"/>	line switch 10
4	VAR_GLOBAL	switch11	BOOL	%MX11	0	<input type="checkbox"/>	<input type="checkbox"/>	line switch 11
5	VAR_GLOBAL	switch12	BOOL	%MX12	0	<input type="checkbox"/>	<input type="checkbox"/>	line switch 12
6	VAR_GLOBAL	switch13	BOOL	%MX13	0	<input type="checkbox"/>	<input type="checkbox"/>	line switch 13
7	VAR_GLOBAL	switch14	BOOL	%MX14	0	<input type="checkbox"/>	<input type="checkbox"/>	line switch 14
8	VAR_GLOBAL	switch15	BOOL	%MX15	0	<input type="checkbox"/>	<input type="checkbox"/>	line switch 15
9	VAR_GLOBAL	switch16	BOOL	%MX16	0	<input type="checkbox"/>	<input type="checkbox"/>	line switch 16
10	VAR_GLOBAL	switch17	BOOL	%MX17	0	<input type="checkbox"/>	<input type="checkbox"/>	line switch 17
11	VAR_GLOBAL	switch18	BOOL	%MX18	0	<input type="checkbox"/>	<input type="checkbox"/>	line switch 18
12	VAR_GLOBAL	switch19	BOOL	%MX19	0	<input type="checkbox"/>	<input type="checkbox"/>	line switch 19
13	VAR_GLOBAL	switch2	BOOL	%MX2	0	<input type="checkbox"/>	<input type="checkbox"/>	line switch 2
14	VAR_GLOBAL	switch20	BOOL	%MX20	0	<input type="checkbox"/>	<input type="checkbox"/>	line switch 20
15	VAR_GLOBAL	switch21	BOOL	%MX21	0	<input type="checkbox"/>	<input type="checkbox"/>	line switch 21
16	VAR_GLOBAL	switch22	BOOL	%MX22	0	<input type="checkbox"/>	<input type="checkbox"/>	line switch 22
17	VAR_GLOBAL	switch23	BOOL	%MX23	0	<input type="checkbox"/>	<input type="checkbox"/>	line switch 23
18	VAR_GLOBAL	switch3	BOOL	%MX3	0	<input type="checkbox"/>	<input type="checkbox"/>	line switch 3
19	VAR_GLOBAL	switch4	BOOL	%MX4	0	<input type="checkbox"/>	<input type="checkbox"/>	line switch 4
20	VAR_GLOBAL	switch5	BOOL	%MX5	0	<input type="checkbox"/>	<input type="checkbox"/>	line switch 5
21	VAR_GLOBAL	switch6	BOOL	%MX6	0	<input type="checkbox"/>	<input type="checkbox"/>	line switch 6
22	VAR_GLOBAL	switch7	BOOL	%MX7	0	<input type="checkbox"/>	<input type="checkbox"/>	line switch 7
23	VAR_GLOBAL	switch8	BOOL	%MX8	0	<input type="checkbox"/>	<input type="checkbox"/>	line switch 8
24	VAR_GLOBAL	switch9	BOOL	%MX9	0	<input type="checkbox"/>	<input type="checkbox"/>	line switch 9
25						<input type="checkbox"/>	<input type="checkbox"/>	

### Notes

- By changing the size of the column, the window previously displayed on the screen can be adjusted
- In View Device, all the areas of the specified type will be displayed on the Direct Variable Comment.
- In Global Variable, incomplete variables displayed on the present screen will be also displayed on the Preview screen

### 4.2.11 Print

It is used to print the window displayed on the screen in Global Variable, Direct Variable Comment and Flag.

[Steps]

1. The window to print shall be displayed on the screen.
2. Select [Project]-[Print] on the menu.

### Notes

- By changing the size of the column, the details to be printed on paper can be adjusted
- In Direct Variable Comment, all the areas of the specified type will be printed
- In Global Variable, incomplete variables displayed on the present screen will be also printed

### 4.2.12 Convenient Functions

#### 1) Align

- Double-click the column header to align in the descending sequence and in the ascending sequence.
- Presently aligned positions are displayed with the arrow direction.

### Notes

- It is available only in Global Variable and Flag.
- If the Flag mode changes to Global Variable, variables will be aligned to display

## Chapter 4 Variable

### 2) View

- Screen Zoom-In: shows the screen magnified.
- Select [View]-[Zoom-In] on the menu.
- Screen Zoom-Out: shows the screen reduced.
- Select [View]-[Zoom-Out] on the menu.
- Use Combo Box for screen Zoom-In/Zoom-Out.
- Select the magnification rate of  in the combo box of the toolbar.
- Width Automatic Adjust: adjusts the column size applicably to the String length of the cell.
- Select [View]-[Resize Width] on the menu.
- Height Automatic Adjust: adjusts the line height applicably to the String height of the cell.
- Select [View]-[Resize Height] on the menu.

### 3) Shortcut Keys

Shortcut Keys	Comment
Home	Used to move to the first in the cell.
End	Used to move to the end in the cell.
Ctrl + Home	Used to move to the first cell position.
Ctrl + End	Used to move to the last cell position.
Shift + Ctrl + Home	From the present to the highest cells selected.
Shift + Ctrl + End	From the present to the lowest cells selected.
Shift + Page Up	From the cell to the page up position selected.
Shift + Page Down	From the cell to the page down position selected.
Shift + Tab, Shift + Enter	Used to move to the next cell (right->left, bottom->top), and to move to the last cell in the first cell.
Tab, Enter	Used to move to the next cell (left->right, top->bottom). A new line will be created in the last call.
Ctrl + Enter	Multi-line will be input in the comment column.

### 4.3 Local Variable

Local Variable declares the variables used in the program or displays the list of declared variables, based on variables.

#### 4.3.1 Local Variable

It declares variables and displays the list of declared local variables.

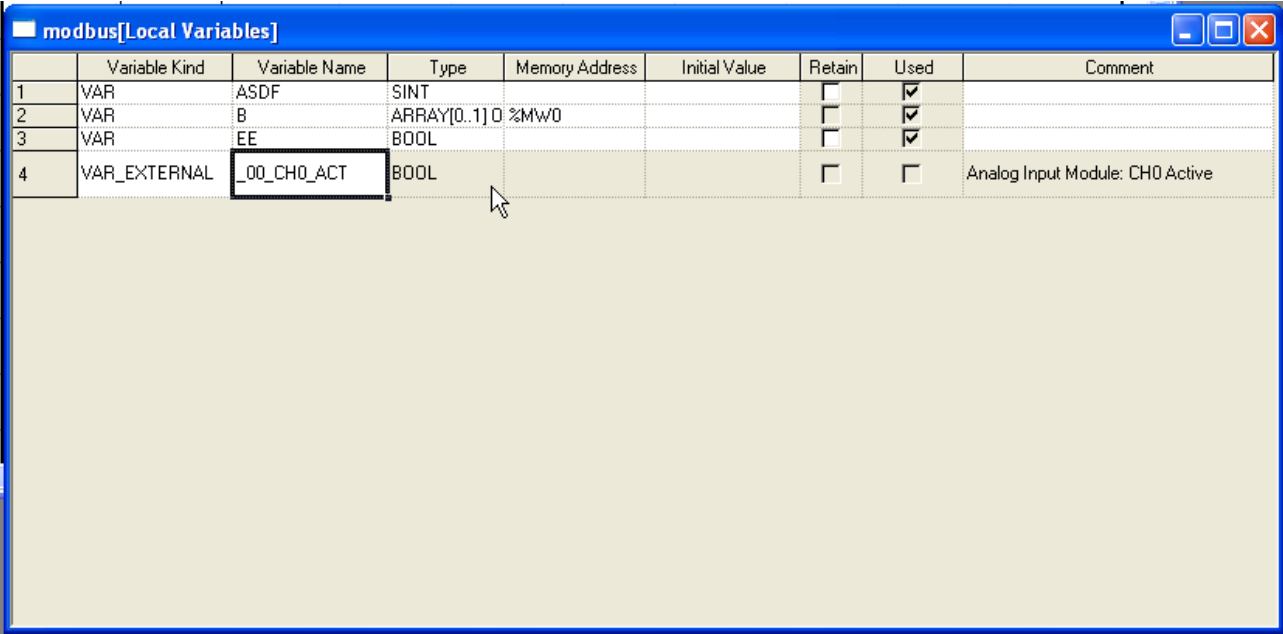

	Variable Kind	Variable Name	Type	Memory Address	Initial Value	Retain	Used	Comment
1	VAR	ASDF	SINT			<input type="checkbox"/>	<input checked="" type="checkbox"/>	
2	VAR	B	ARRAY[0..1] D	%MW0		<input type="checkbox"/>	<input checked="" type="checkbox"/>	
3	VAR	EE	BOOL			<input type="checkbox"/>	<input checked="" type="checkbox"/>	
4	VAR_EXTERNAL	_00_CH0_ACT	BOOL			<input type="checkbox"/>	<input type="checkbox"/>	Analog Input Module: CH0 Active



## 4.4 Local Variable Edit

On the list of the presently declared local variables, variable kind, variable name, type, memory address, initial value, retain, use or not and comment can be edited. In addition, it adds the local variables used in the program to the list of local variables.

### 4.4.1 Local Variable Registration

Register local variable to use in the program. To register on the list of local variable, Local Variable is used.

#### 1) Register in Local Variable

A variable can be added, modified or deleted to/from the list of local variables.

[Dialog Box]

	Variable Kind	Variable Name	Type	Memory Address	Initial Value	Retain	Used	Comment
1	VAR	ASDF	SINT			<input type="checkbox"/>	<input checked="" type="checkbox"/>	
2	VAR	B	ARRAY[0..1] D	%Mw0		<input type="checkbox"/>	<input checked="" type="checkbox"/>	
3	VAR	EE	BOOL			<input type="checkbox"/>	<input checked="" type="checkbox"/>	
4	VAR_EXTERNAL	<u>_00_CH0_ACT</u>	BOOL			<input type="checkbox"/>	<input type="checkbox"/>	Analog Input Module: CH0 Active

[Description of Dialog Box]

- a. Variable kind: VAR, VAR\_CONSTANT and VAR\_EXTERNAL, VAR\_EXTERNAL\_CONSTANT are available.
  - If variable type is CONSTANT, it sets the initial value as the default.
  - If the variable type is VAR\_EXTERNAL or VAR\_EXTERNAL\_CONSTANT, the columns of the initial value and retain value are displayed as the defaults.
- b. Variable name: The declared variable can not be duplicated with the identical name.
  - A figure is unavailable for the first character.
  - A special character is unavailable. (However, '\_' is available.)
  - Space is not available as a character.
  - A name same with direct variable can not be used as a name(i.e. MB4, W4, RW9...)
  - If a line is empty, BOOL is displayed as the default type when entering a variable.
- c. Type: 23 types are available; 20 basic types and 3 induced types.
  - Basic types(20): (BOOL, BYTE, WORD, DWORD, LWORD, SINT, INT, DINT, LINT, USINT, UINT, UDINT, ULINT, REAL, LREAL, TIME, DATE, TIME\_OF\_DAY, DATE\_AND\_TIME, STRING)
  - Induced types(3): ARRAY(i.e. ARRAY[0..6,0..2,0..4] OF BOOL) => factor limit (up to 3rd), STRUCT(i.e. STRUCT name display) => STRUCT type is no available in STRCT, FB\_INST(i.e., FB name display)
- d. Memory address: enter it by using direct variable(I, Q, M, R, W).
- e. Initial value: default value can be set.
- f. Retain: if memory allocation is set, retain column is inactive.
  - R, W: always retain area.
  - M: check it by obtaining basic parameter information.
  - I, Q: always not retain area.
- g. Used: display whether to use a declared variable.
- h. Comment: every character is available.
  - Multi line entry is available by using Ctrl + Enter key.
- i. Line validity: To register on global variable window, it needs variable type, variable and type.
  - If not registered on global variable, it displays in pink.

### Notes

- If any error occurs when editing a cell, it is displayed in pink.
- Press ESC key to recover the previous value during the cell edit.

### 4.4.2 Copy, Cut, Delete and Paste

Copy, cut, delete or paste can be executed to edit the list of local variables used in the program

#### 1) Copy

It is used to save the data of the area selected to copy in the clipboard. The copied details can be added to the present project or other projects. Paste on other applications is also available.

[Steps]

1. Select the area to copy.
2. Select [Edit] - [Copy] on the menu.

#### Notes

- How to select the area is as follows;
- Use the mouse to select the cell of (0,0) in order to select the whole table
- Select [Edit] - [Select All] in order to select the whole table.
- Use the mouse to select the column header of the cell in order to select the whole columns.
- Use the mouse to select the row header of the cell in order to select the whole rows.
- Use the mouse to drag the part of the cell in order to select the area.
- Use Shift + Arrow keys on the keyboard in order to select the area.

#### 2) Delete

It is used to delete the data of the selected area from the list of local variables.

[Steps]

1. Select the area to delete.
2. Select [Edit] - [Delete] on the menu.

#### 3) Cut

It is used to save the selected data in the clipboard in order to add to the present project or other projects. Besides, it will delete the selected data.

[Steps]

1. Select the area to cut.
2. Select [Edit]-[Cut] on the menu.

4) Paste

It displays the data saved in the clipboard on the selected position. If the data is already displayed, the Dialog Box will be called to select and change the data.

\* If the data saved in the clipboard is a part of columns,

[Steps]

1. Select the position to paste on.
2. Select [Edit]-[Paste] on the menu.
3. If the variable and direct variable are identical on the list of variables/comments, the dialog box will be called.

[Dialog Box]

The dialog box 'Sets the variable/device when pasting' contains the following table:

	Application	Variable Kind	Variable	Type	Address	Initial Value	Retain	Used	Comment
1	<input checked="" type="checkbox"/>	VAR	P0	BOOL	%MX0		<input type="checkbox"/>	<input type="checkbox"/>	contact0
		VAR	P0	BOOL	%MX0		<input type="checkbox"/>	<input type="checkbox"/>	contact0
2	<input checked="" type="checkbox"/>	VAR	P1	BOOL	%MX1		<input type="checkbox"/>	<input type="checkbox"/>	contact1
		VAR	P1	BOOL	%MX1		<input type="checkbox"/>	<input type="checkbox"/>	contact1
3	<input checked="" type="checkbox"/>	VAR	P2	BOOL	%MX2		<input type="checkbox"/>	<input type="checkbox"/>	contact2
		VAR	P2	BOOL	%MX2		<input type="checkbox"/>	<input type="checkbox"/>	contact2
4	<input checked="" type="checkbox"/>	VAR_CONSTANT	P3	BOOL	%MX3	0	<input type="checkbox"/>	<input type="checkbox"/>	contact3
		VAR_CONSTANT	P3	BOOL	%MX3	0	<input type="checkbox"/>	<input type="checkbox"/>	contact3
5	<input checked="" type="checkbox"/>	VAR_CONSTANT	P4	BOOL	%MX4	0	<input type="checkbox"/>	<input type="checkbox"/>	contact4
		VAR_CONSTANT	P4	BOOL	%MX4	0	<input type="checkbox"/>	<input type="checkbox"/>	contact4
6	<input checked="" type="checkbox"/>	VAR_CONSTANT	P5	BOOL	%MX5	0	<input type="checkbox"/>	<input type="checkbox"/>	contact5
		VAR_CONSTANT	P5	BOOL	%MX5	0	<input type="checkbox"/>	<input type="checkbox"/>	contact5
7	<input checked="" type="checkbox"/>	VAR	P6	BOOL	%MX6		<input type="checkbox"/>	<input type="checkbox"/>	contact6
		VAR	P6	BOOL	%MX6		<input type="checkbox"/>	<input type="checkbox"/>	contact6
8	<input checked="" type="checkbox"/>	VAR	P7	BOOL	%MX7		<input type="checkbox"/>	<input type="checkbox"/>	contact7
		VAR	P7	BOOL	%MX7		<input type="checkbox"/>	<input type="checkbox"/>	contact7
9	<input checked="" type="checkbox"/>	VAR	P8	BOOL	%MX8		<input type="checkbox"/>	<input type="checkbox"/>	contact8
		VAR	P8	BOOL	%MX8		<input type="checkbox"/>	<input type="checkbox"/>	contact8

Buttons on the right: OK, Cancel, Select All, Unselect All.

Comment box content:  
 Variable/Direct variable to paste is duplicated  
 Upper row displays the Variable/Direct variable in existing Variable/Direct variable, lower row displays the Variable/Direct variable to paste  
 New Variable/Direct variable applies when column replace is selected  
 All cell areas except column replace are not editable.

## Chapter 4 Variable

[Comment of Dialog Box]

- Number: used to display the duplicated number of the variables and direct variables to paste
- Replace: used to apply Paste.
- Gray Line: used to display the existing list of variables/comments, which will not be edited.
- White Line: used to display the list of variables/comments obtained from the clipboard, which will not be edited.
- OK: applies the lines of the selected check box. The existing list of variables/comments will be deleted to add a new list of variables/comments.
- Cancel: The existing list of variables/comments will not be deleted, and a new the list of variables/comments will not be applied accordingly.
- Select All: used to check all the check boxes in the [Replace] column.
- Unselect All: used to cancel all the selected check boxes in the [Replace] column.

\* If the data saved in the clipboard is of the partial column,

[Steps]

- Select the position to paste on.
- Select [Edit] – [Paste] on the menu.
- If the variable and direct variable are identical on the list of variables/comments, the dialog box will be called.

[Dialog Box]

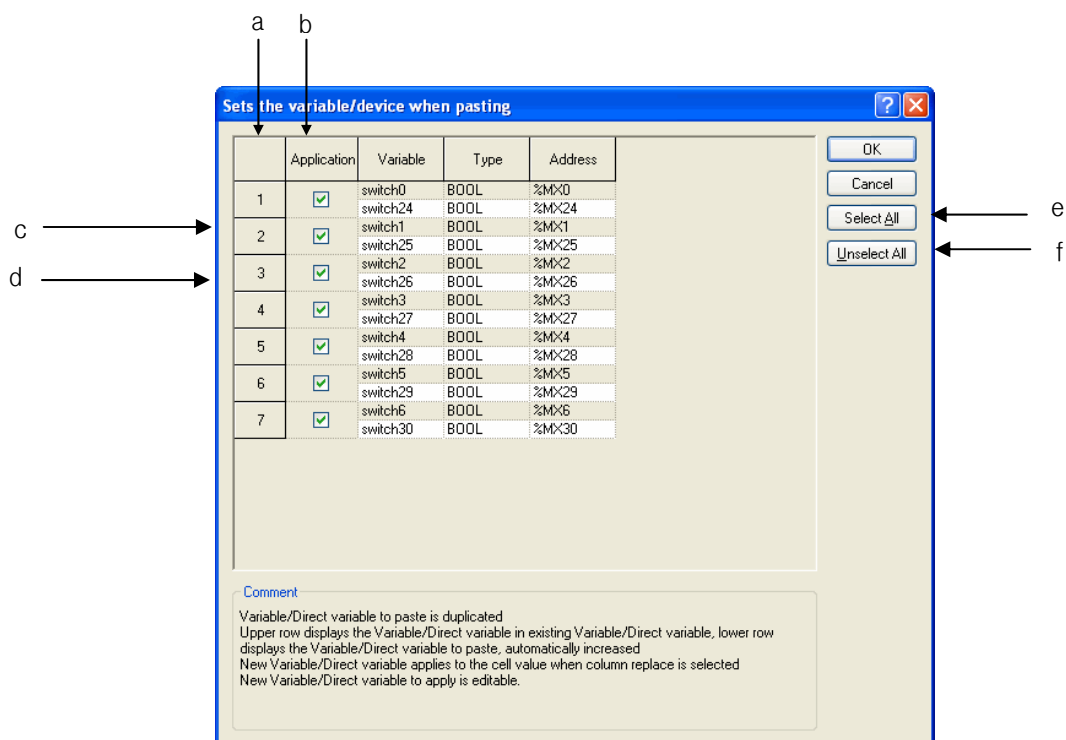

[Description of Dialog Box]

- a. Number: used to display the duplicated number of the variables and direct variables to paste.
- b. Application: used to apply Paste.
- c. Gray Line: used to display the data in the existing cell, which will not be edited.
- d. White Line: If the variable or device of the data to paste is duplicated, it will be automatically increased and then displayed on the screen. In addition, the cell can be edited.
- e. Select All: used to check all the check boxes in the [Replace] column.
- f. Unselect All: used to cancel all the selected check boxes in the [Replace] column.

### Notes

- If all items are identical, the cell can not be edited, while if partially identical, the cell can be edited.
- If the number of the columns saved in the clipboard is greater than the number of the columns to paste, it is not possible to paste.
- If the data saved in the clipboard is greater than the number of the lines to paste, it is not possible to paste.

### 4.4.3 Insert line

It is used to insert new lines as many as the lines of the selected area, which will make the existing lines move downward.

[Steps]

## Chapter 4 Variable

1. Select the area to insert the lines into.
2. Select [Edit] - [Insert Line] on the menu.

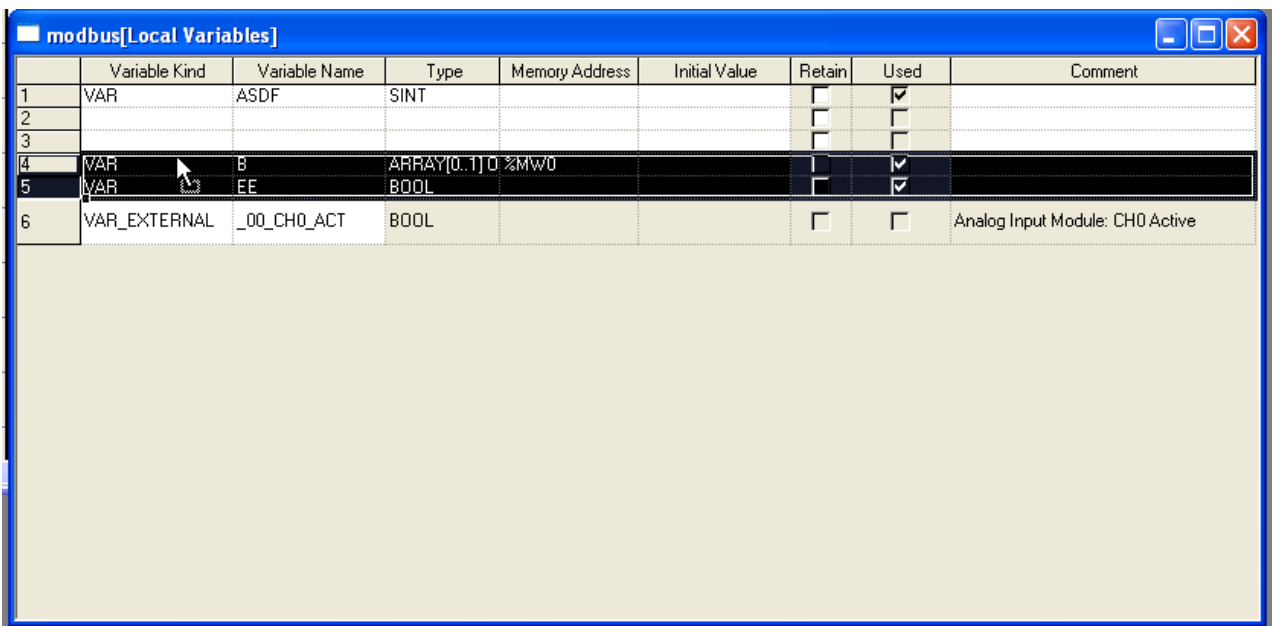
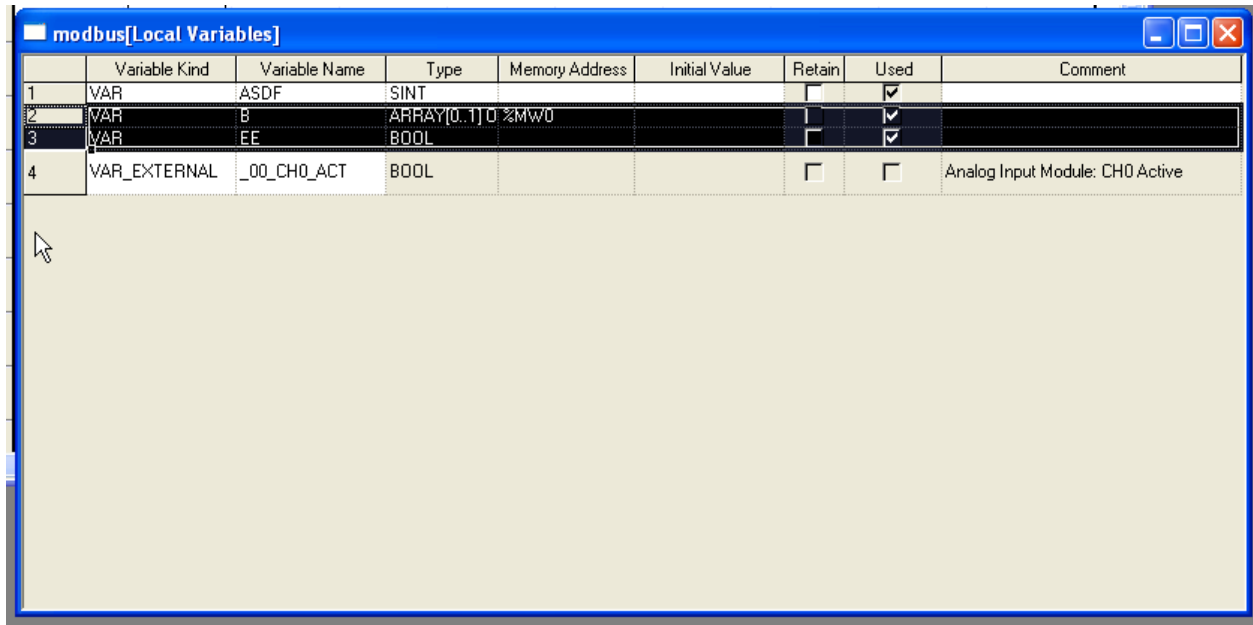

### Notes

- If no cell is selected, one line will be added to the first line.
- If Enter key or Tab key is selected at the last of the lines, a new line will be created.

### 4.4.4 Delete line

It is used to delete the lines as many as the lines of the selected area.

[Steps]

- 1. Select the area to delete the lines from.
- 2. Select [Edit] - [Delete Line] on the menu.

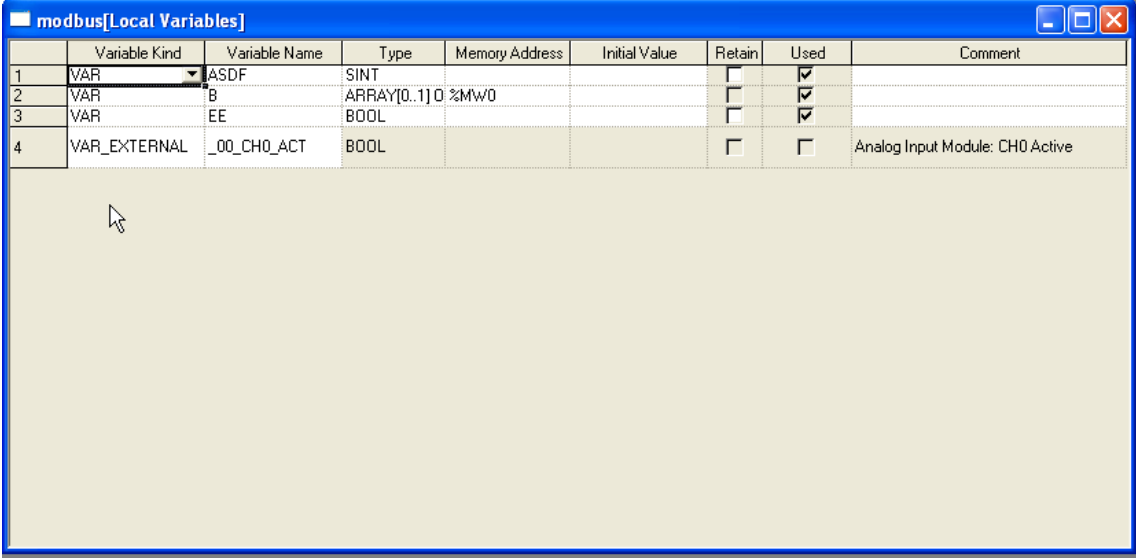
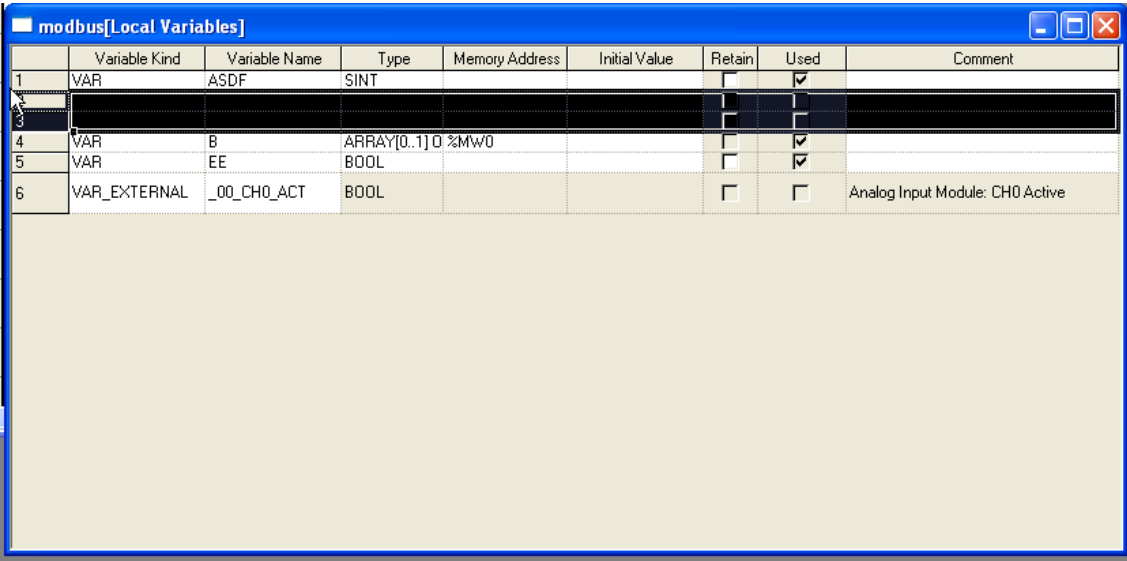

**Notes**

- If no cell is selected, [Delete Line] will not be executed.



## Chapter 4 Variable

### 4.4.5 Automatic fill

It is used to increase or decrease variables and direct variables to add on the list of variables/comments.

[Steps]

1. Move the mouse to the end of the cell and the mouse cursor will change to + shape.
2. Move the mouse upward and downward with its left button being pressed.

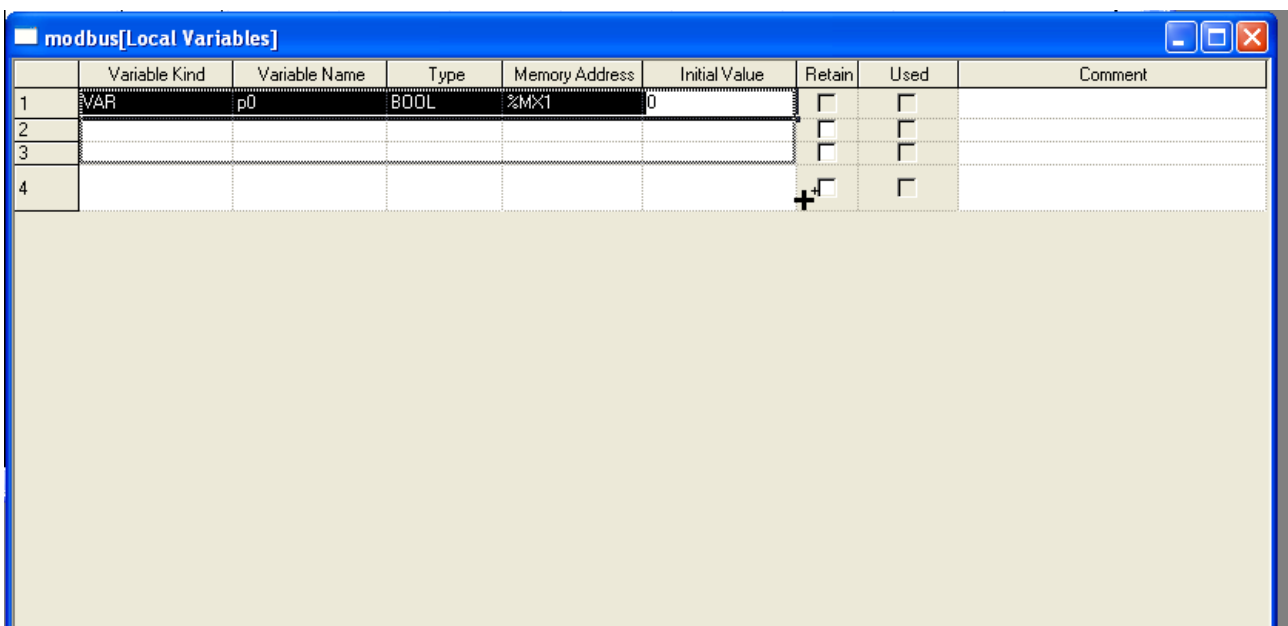
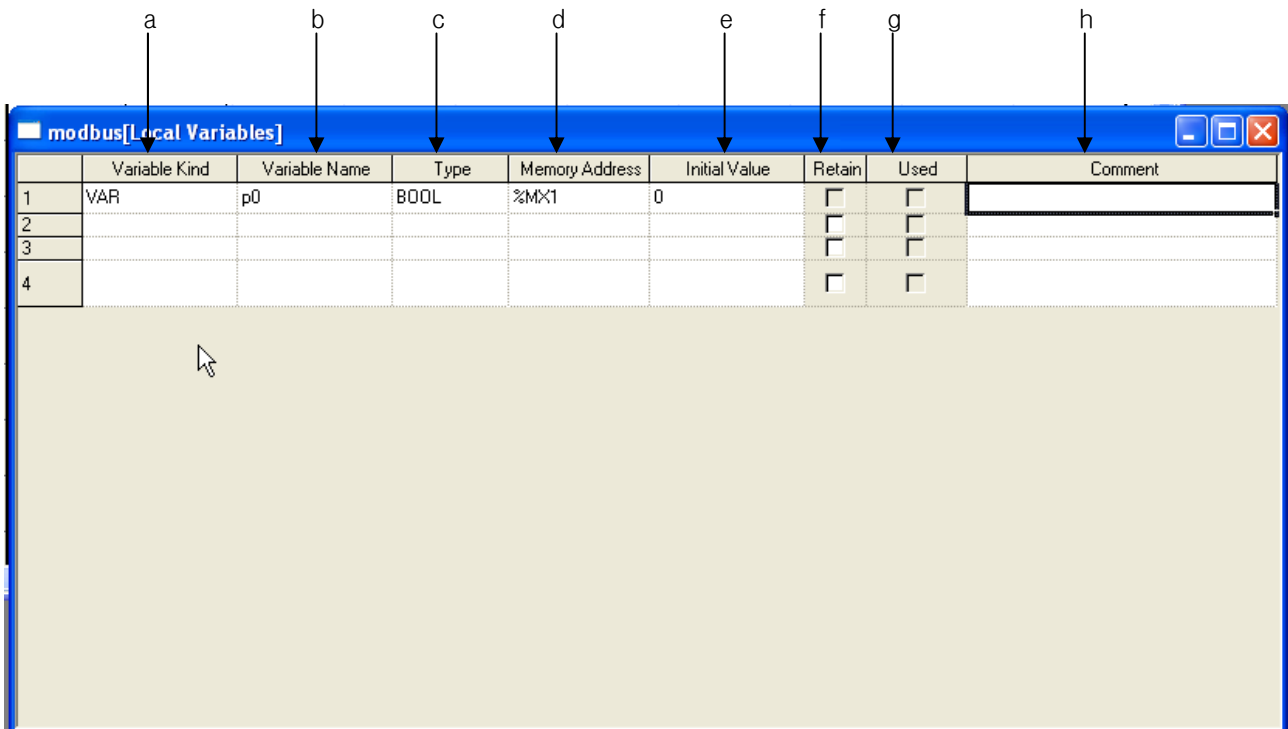

	Variable Kind	Variable Name	Type	Memory Address	Initial Value	Retain	Used	Comment
1	VAR	p0	BOOL	%MX1	0	<input type="checkbox"/>	<input type="checkbox"/>	
2	VAR	p1	BOOL	%MX2	0	<input type="checkbox"/>	<input type="checkbox"/>	
3	VAR	p2	BOOL	%MX3	0	<input type="checkbox"/>	<input type="checkbox"/>	
4						<input type="checkbox"/>	<input type="checkbox"/>	

[Description of dialog box]

- a. Variable kind: the value is filled in a cell as copied.
- b. Variable name: it always executes Automatic Fill because a variable can not be declared in duplicate. If it contains a number, it automatically increases. If not, it adds a number at the end and counts it automatically.
- c. Type: it is filled in a cell as copied.
- d. Memory address: it always executes Automatic Fill because memory allocation can not be declared in duplicate. If it contains a number, it searches for the part and increases it automatically.
- e. Initial value: it is filled in a cell as copied.
- f. Retain: it is checked as copied.
- g. Used: it can not be modified because of Read Only.
- h. Comment: If Automatic Fill is executed with Ctrl key being pressed, the figures area will automatically increase, and if with Ctrl key not pressed, it will be copied.

**Notes**

- If Automatic Fill is executed with an empty cell, it will be deleted.
- Automatic Fill is available for many cells.

## Chapter 4 Variable

### 4.4.6 Drag & Drop

It is used to copy the selected items to paste on different positions.

[Steps]

1. Select the area to drag and drop.
2. The mouse cursor will change to the state available for drag and drop.
3. With the left mouse button being pressed, drag and drop the selected items onto a position to paste on.

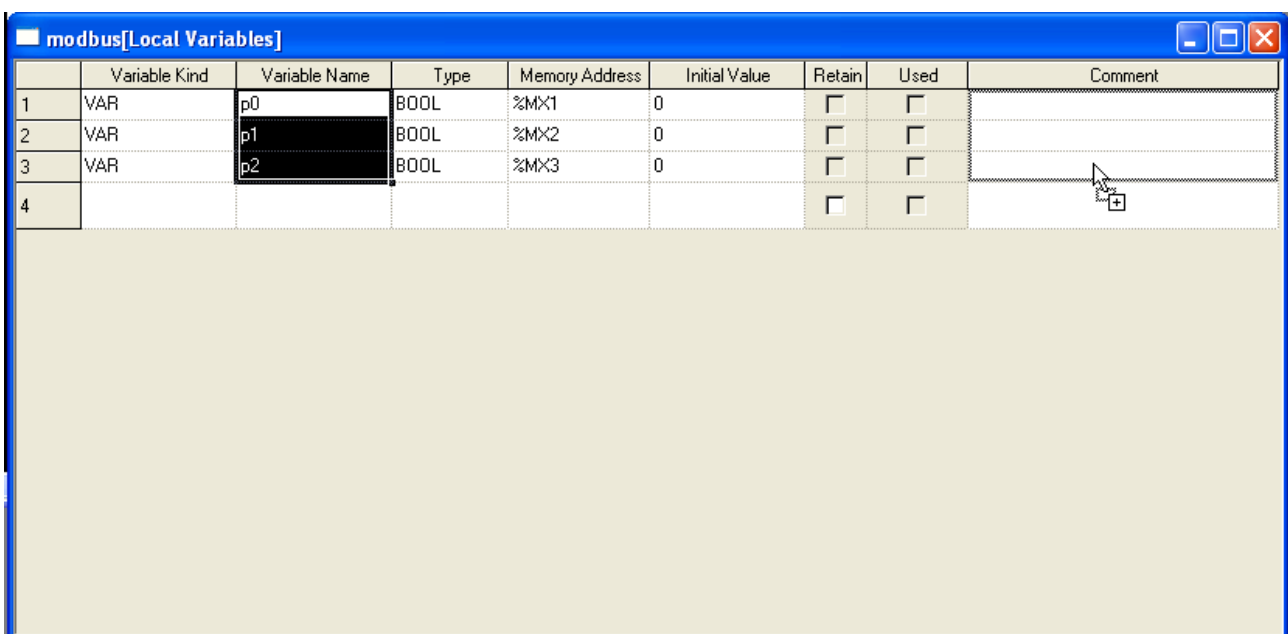
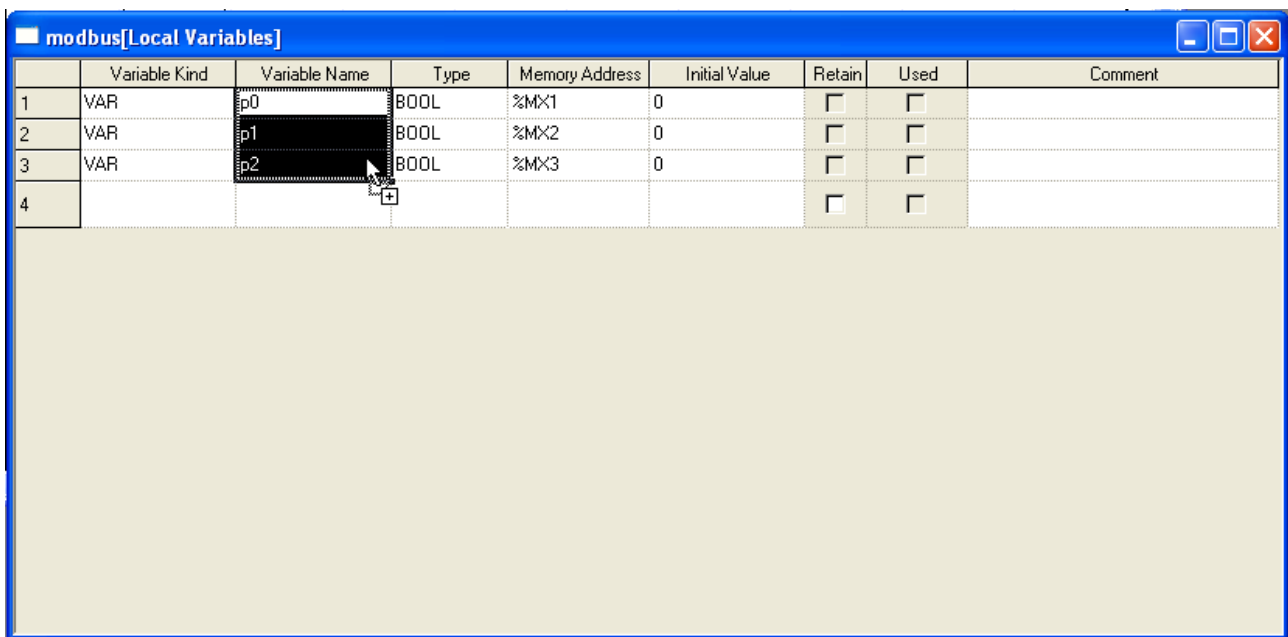

modbus[Local Variables]								
	Variable Kind	Variable Name	Type	Memory Address	Initial Value	Retain	Used	Comment
1	VAR	p0	BOOL	%MX1	0	<input type="checkbox"/>	<input type="checkbox"/>	p0
2	VAR	p1	BOOL	%MX2	0	<input type="checkbox"/>	<input type="checkbox"/>	p1
3	VAR	p2	BOOL	%MX3	0	<input type="checkbox"/>	<input type="checkbox"/>	p2
4						<input type="checkbox"/>	<input type="checkbox"/>	

### [Details]

- Drag and drop is available onto Variable Monitoring Window.
- Drag and drop is available onto LD Window.
- Copy is available when drag and drop is executed onto Excel program.
- Drag and drop is available onto Data Traces window.
- Drag and drop is available onto Global Variable of other XG5000 programs.

### Notes

Data is not moved but just copied always when dragged and dropped.

### 4.4.7 Undo/Redo

Undo is used to cancel the edited detail in order to return to its previous state. Redo cancels again the operation of Edit Cancel.

### [Details]

- Undo/Redo is available for Cell Edit.
- Undo/Redo is available for Change.
- Undo/Redo is available for All Change.
- Undo/Redo is available for Delete.
- Undo/Redo is available for Cut.
- Undo/Redo is available for Paste.

## Chapter 4 Variable

7. Undo/Redo is available for Automatic Fill.
8. Undo/Redo is available for Insert Line. (Only in Global Variable)
9. Undo/Redo is available for Delete Line. (Only in Global Variable)
10. Undo/Redo is available for drag and drop.
11. Undo/Redo is available for Align. (Only in Global Variable)
12. If EXTERNAL variable is added, it executes Undo/Redo.

### 4.4.8 Export to file

It is used to save the previously declared list of global variables on the file and to open and read in the external programs.

[Steps]

1. Select [Edit] - [Export to File] on the menu.

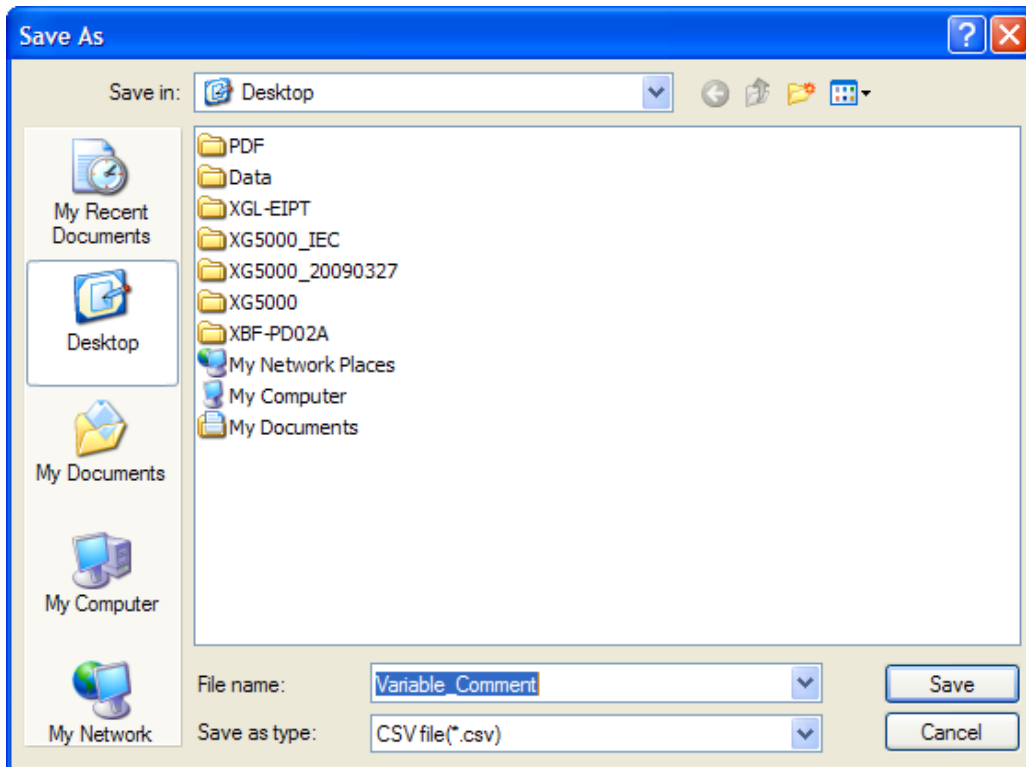

If you press 'Save', file is saved as inputted file name at selected folder location.

If you press 'Cancel', file is not created and dialog box is closed

File is classified by tap.

### 4.4.9 Add EXTERNAL Variable

The list created by Global Variable can be loaded by Add External Variable.

[Steps]

- 1. Select [Edit]-[Add EXTERNAL Variable] on the menu.
- 2. Global Variable Selection Dialog Box will be called.

[Dialog box]

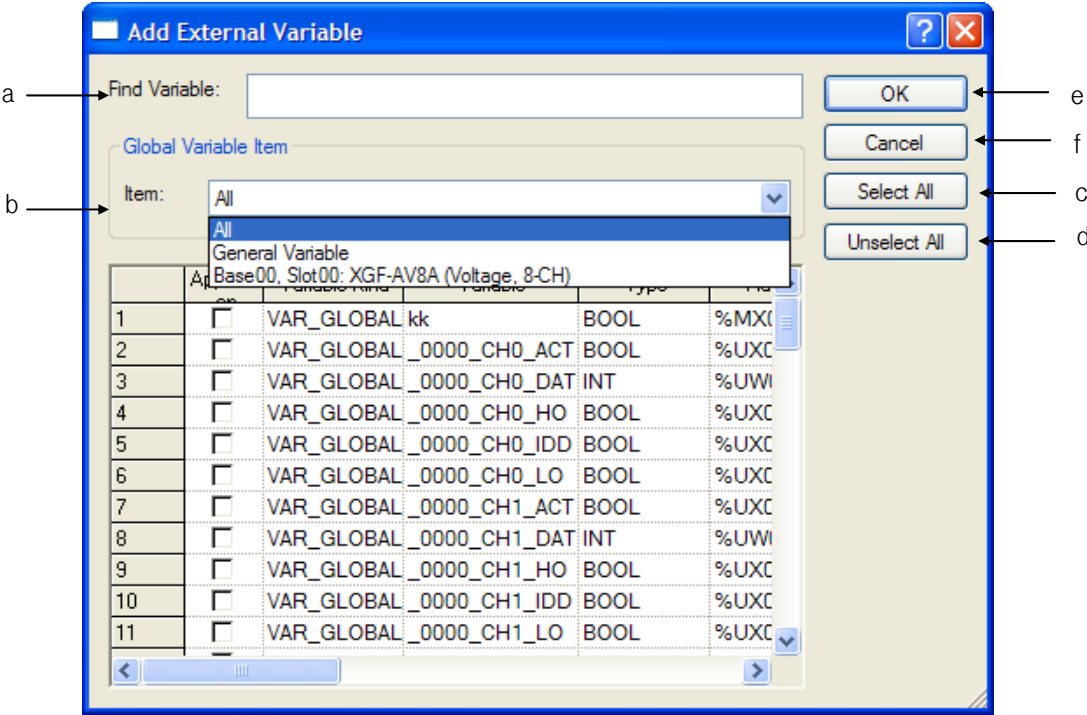

[Description of dialog box]

- a. Find Variable: finds variable meeting the condition at information of Global Variable Item
- b. Global Variable item: at declared global variable item, displays items according to item types. All, general variable, special module - related variable
- c. Select All: selects all application column at global variable item
- d. Unselect All: unselects all application columns at global variable item
- e. OK: Closes dialog box and registers global variable as External variable.
- f. Cancel: closes dialog box and doesn't register the selected variable as External variable

## Chapter 4 Variable

[Global variable item – All]

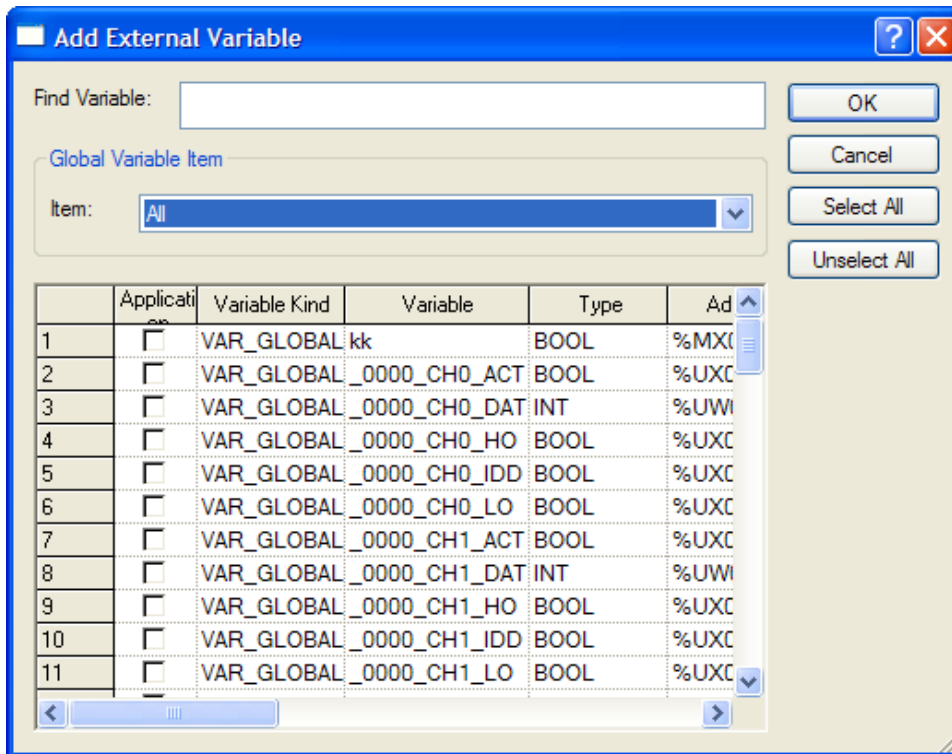

[Global variable item – General Variable]

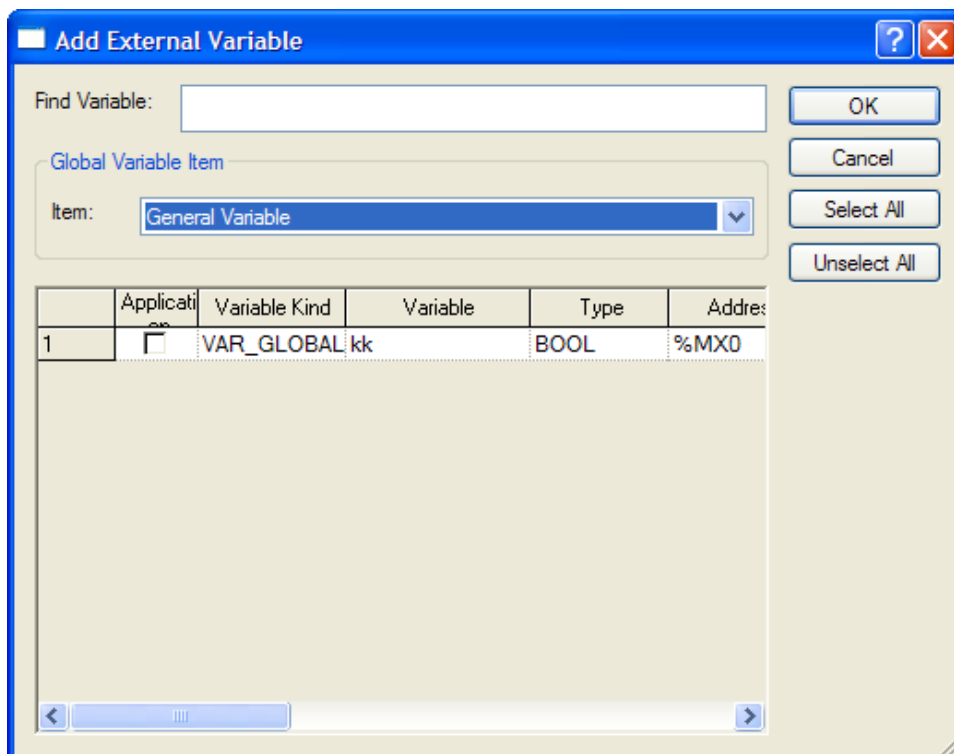

[Global variable item – special module related variable]

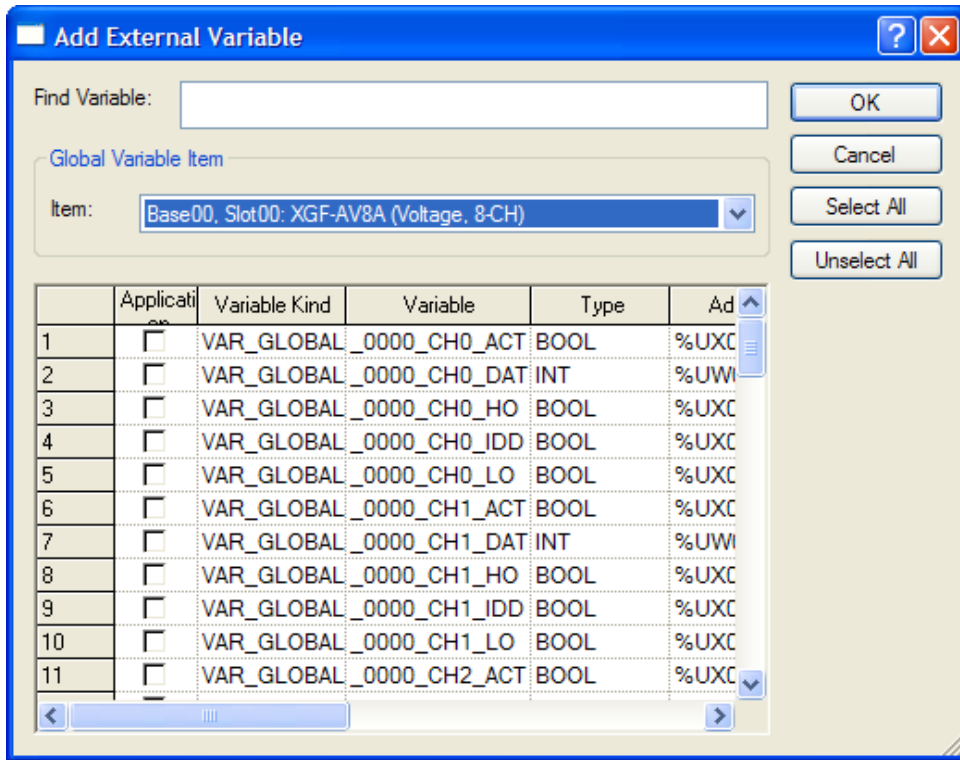



### 4.5 FB Variable

FB variable memorizes operation results in a command such as timer and counter and declares the variable of operation unit using the results of operation memorized by several scans or displays the list of declared variables, based on the variables.

#### 4.5.1 FB Variable

It declares the variable and displays the list of declared FB variables.

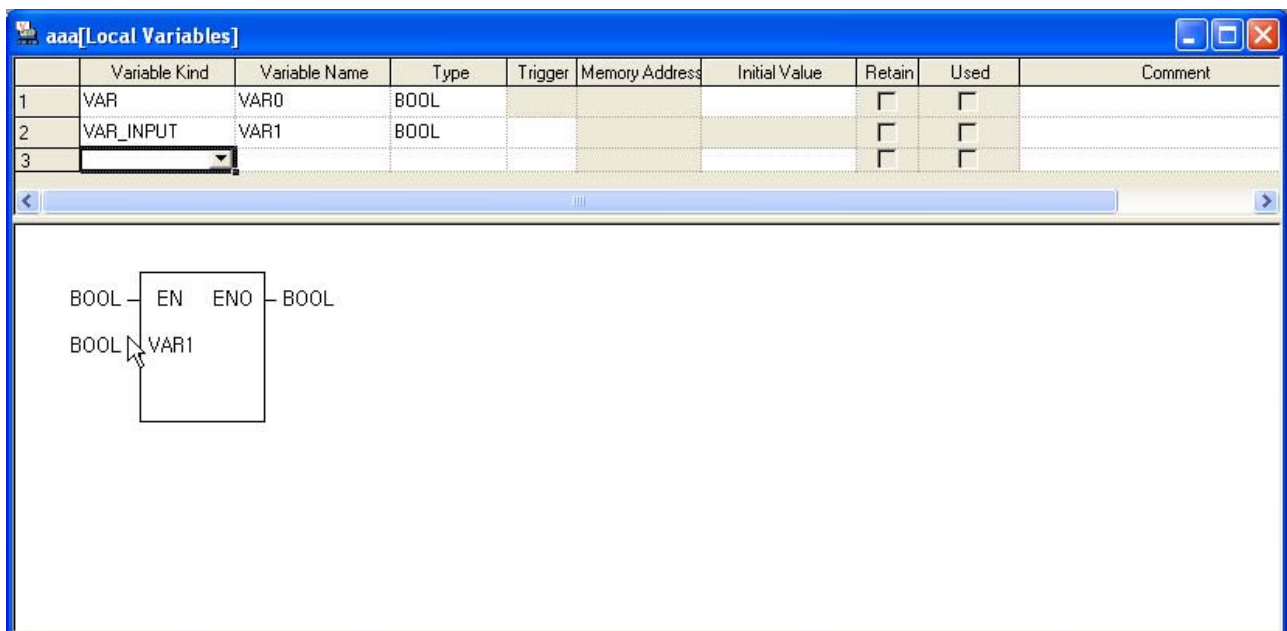

The screenshot shows a software window titled "aaa[Local Variables]". It contains a table with the following data:

	Variable Kind	Variable Name	Type	Trigger	Memory Address	Initial Value	Retain	Used	Comment
1	VAR	VAR0	BOOL				<input type="checkbox"/>	<input type="checkbox"/>	
2	VAR_INPUT	VAR1	BOOL				<input type="checkbox"/>	<input type="checkbox"/>	
3							<input type="checkbox"/>	<input type="checkbox"/>	

Below the table is a scrollable area containing a ladder logic diagram. The diagram shows a normally open contact labeled "VAR1" connected to a coil. The coil is labeled "EN" and "ENO" with "BOOL" written next to it. A mouse cursor is pointing at the "VAR1" contact.

## 4.6 FB Variable Edit

On the list of the presently declared FB variables, variable kind, variable name, type, trigger, memory address, initial value, retain, use or not and comment items can be edited. In addition, a new FB variable can be added to the list of the FB variables.

### 4.6.1 FB Variable Registration

This is used to register FB variables to use in the program.

#### 1) Register in FB Variable

A variable can be added to the list of FB variables, modified or deleted from it.

[Dialog Box]

The dialog box 'aaa[Local Variables]' contains a table with the following data:

	Variable Kind	Variable Name	Type	Trigger	Memory Address	Initial Value	Retain	Used	Comment
1	VAR	VAR0	BOOL				<input type="checkbox"/>	<input type="checkbox"/>	
2	VAR_INPUT	VAR1	BOOL				<input type="checkbox"/>	<input type="checkbox"/>	
3	<input type="text"/>						<input type="checkbox"/>	<input type="checkbox"/>	

Below the table is a scrollable area containing a ladder logic diagram. The diagram shows a normally open contact labeled 'VAR1' connected to a coil labeled 'EN'. The output of the coil is labeled 'ENO' and is connected to a terminal labeled 'BOOL'. Another terminal labeled 'BOOL' is shown on the left side of the diagram.

## Chapter 4 Variable

[Description of Dialog Box]

- a. Variable kind: VAR, VAR\_CONSTANT, VAR\_INPUT, VAR\_OUTPUT, VAR\_IN\_OUT, VAR\_EXTERNAL and VAR\_EXTERNAL\_CONSTANT are available.
  - If a variable type is CONSTANT, the initial value is set as the default.
  - VAR\_INPUT, VAR\_OUTPUT and VAR\_IN\_OUT can not set the initial value.
- b. Variable name: The declared variable can not be duplicated with the identical name.
  - A figure is unavailable for the first character.
  - A special character is unavailable. (However, '\_' is available.)
  - Space is not available as a character.
  - A same name with a direct variable is unavailable(i.e. MB4, W4, RW9,...)
  - If a line is empty, BOOL is displayed as the default type when entering a variable.
- c. Type: 23 types are available; 20 basic types and 3 induced types.
  - Basic type(20): (BOOL, BYTE, WORD, DWORD, LWORD, SINT, INT, DINT, LINT, USINT, UINT, UDINT, ULINT, REAL, LREAL, TIME, DATE, TIME\_OF\_DAY, DATE\_AND\_TIME, STRING)
  - Induced type(3): ARRAY(예, ARRAY[0..6,0..2,0..4] OF BOOL) => factor limit (up to 3rd), STRUCT(i.e. STRUCT name display) => STRUCT type is not available in STRUCT(i.e. FB name display)
- d. Trigger: it is VAR\_INPUT or VAR\_IN\_OUT and active only in BOOL type; it can set R and F status.
- e. Memory address: it can not be declared as Read Only.
- f. Initial Value: it can be set.
  - Initial value can not be set if the variable type is VAR\_INPUT, VAR\_OUTPUT or VAR\_IN\_OUT.
- g. Retain: it can not be declared as Read Only.
- h. Used: it can not be declared as Read Only.
- i. Comment: every character is available.
  - Multi line entry is available by using Ctrl + Enter key.
- j. Line validity: To register on global variable window, it needs variable type, variable and type.
  - If not registered on global variable, it displays in pink.

### Notes

- If any error occurs when editing a cell, it is displayed in pink.
- Press ESC key to recover the previous value during the cell edit.

## 4.6.2 Copy, Cut, Delete and Paste

Copy, cut, delete or paste can be executed to edit the list of local variables used in the program.

### 1) Copy

It is used to save the data of the area selected to copy in the clipboard. The copied details can be added to the present project or other projects. Paste on other applications is also available.

[Steps]

1. Select the area to copy.
2. Select [Edit] - [Copy] on the menu.

#### Notes

- How to select the area is as follows;
- Use the mouse to select the cell of (0,0) in order to select the whole table
- Select [Edit] - [Select All] in order to select the whole table.
- Use the mouse to select the column header of the cell in order to select the whole columns.
- Use the mouse to select the row header of the cell in order to select the whole rows.
- Use the mouse to drag the part of the cell in order to select the area.
- Use Shift + Arrow keys on the keyboard in order to select the area.

### 2) Delete

It is used to delete the data of the selected area from the list of local variables.

[Steps]

1. Select the area to delete.
2. Select [Edit] - [Delete] on the menu.

### 3) Cut

It is used to save the selected data in the clipboard in order to add to the present project or other projects. Besides, it will delete the selected data.

[Steps]

1. Select the area to cut.
2. Select [Edit]-[Cut] on the menu.

## Chapter 4 Variable

### 4) Paste

It displays the data saved in the clipboard on the selected position. If the data is already displayed, the Dialog Box will be called to select and change the data.

\* If the data saved in the clipboard is a part of columns,

[Steps]

1. Select the position to paste on.
2. Select [Edit]-[Paste] on the menu.
3. If the variable and direct variable are identical on the list of variables/comments, the dialog box will be called.

[Dialog Box]

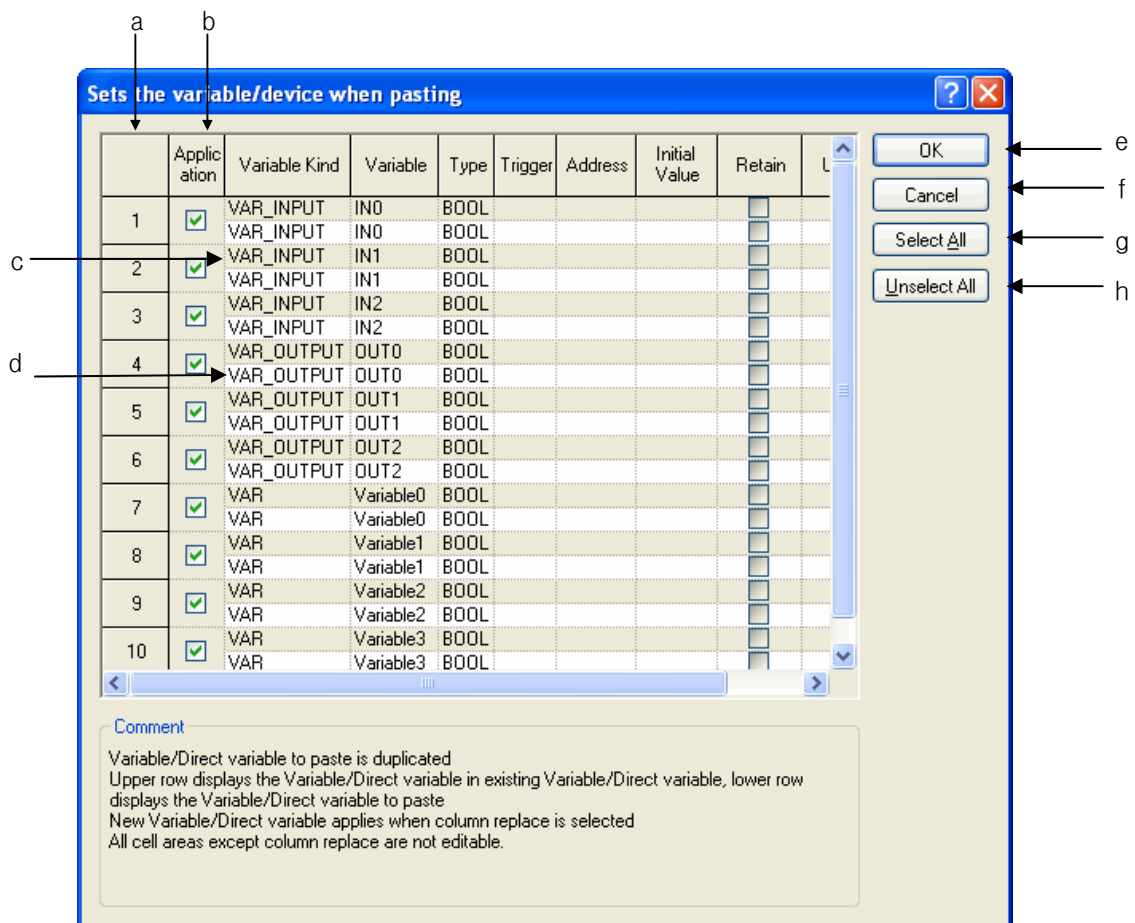

[Comment of Dialog Box]

- a. Number: used to display the duplicated number of the variables and direct variables to paste
- b. Replace: used to apply Paste.
- c. Gray Line: used to display the existing list of variables/comments, which will not be edited.
- d. White Line: used to display the list of variables/comments obtained from the clipboard, which will not be edited.
- e. OK: applies the lines of the selected check box. The existing list of variables/comments will be deleted to add a new list of variables/comments.
- f. Cancel: The existing list of variables/comments will not be deleted, and a new the list of variables/comments will not be applied accordingly.
- g. Select All: used to check all the check boxes in the [Replace] column.
- h. Unselect All: used to cancel all the selected check boxes in the [Replace] column.

\* If the data saved in the clipboard is of the partial column,

[Steps]

1. Select the position to paste on.
2. Select [Edit] – [Paste] on the menu.
3. If the variable and direct variable are identical on the list of variables/comments, the dialog box will be called.

[Dialog Box]

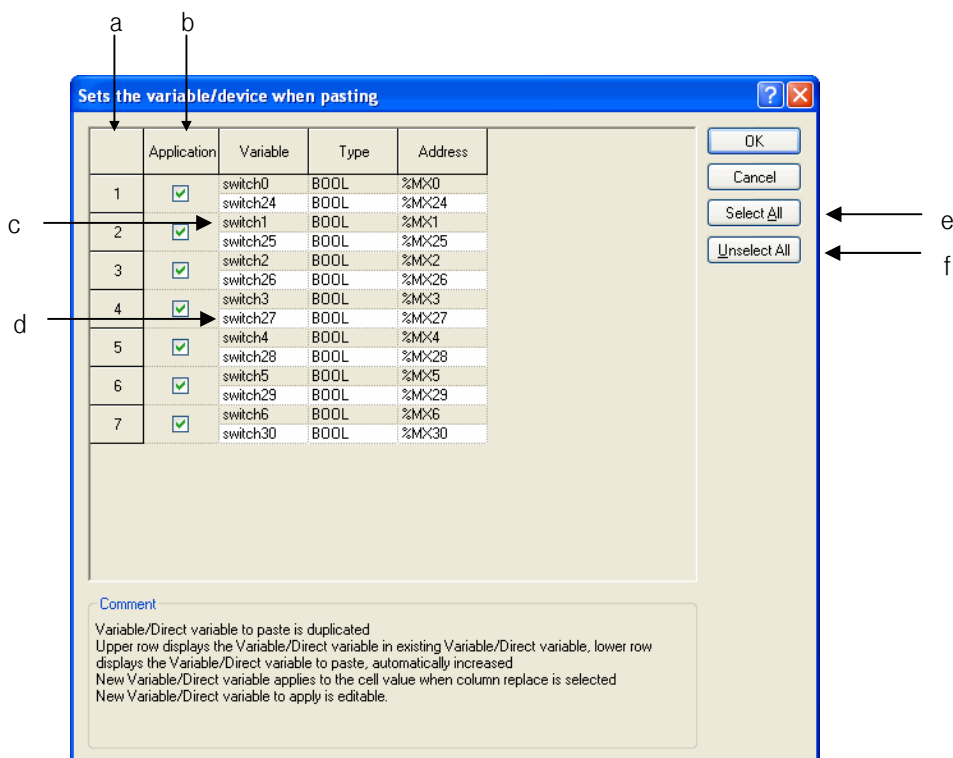

[Comment of Dialog Box]

- a. Number: used to display the duplicated number of the variables and direct variables to paste.
- b. Replace: used to apply Paste.
- c. Gray Line: used to display the data in the existing cell, which will not be edited.
- d. White Line: If the variable or device of the data to paste is duplicated, it will be automatically increased and then displayed on the screen. In addition, the cell can be edited.
- e. Select All: used to check all the check boxes in the [Replace] column.
- f. Unselect All: used to cancel all the selected check boxes in the [Replace] column.

### Notes

- If all items are identical, the cell can not be edited, while if partially identical, the cell can be edited.
- If the number of the columns saved in the clipboard is greater than the number of the columns to paste, it is not possible to paste.
- If the data saved in the clipboard is greater than the number of the lines to paste, it is not possible to paste.

### 4.6.3 Insert line

It is used to insert new lines as many as the lines of the selected area, which will make the existing lines move downward.

[Steps]

1. Select the area to insert the lines into.
2. Select [Edit] - [Insert Line] on the menu.

aaa[Local Variables]

	Variable Kind	Variable Name	Type	Trigger	Memory Address	Initial Value	Retain	Used	Comment
1	VAR	VAR0	BOOL				<input type="checkbox"/>	<input type="checkbox"/>	
2	VAR_INPUT	VAR1	BOOL				<input type="checkbox"/>	<input type="checkbox"/>	
3	VAR_OUTPUT	VAR2	BOOL				<input type="checkbox"/>	<input type="checkbox"/>	
4	VAR_EXTERNAL	p0	BOOL		%MX0		<input type="checkbox"/>	<input type="checkbox"/>	

aaa[Local Variables]

	Variable Kind	Variable Name	Type	Trigger	Memory Address	Initial Value	Retain	Used	Comment
1	VAR	VAR0	BOOL				<input type="checkbox"/>	<input type="checkbox"/>	
2							<input type="checkbox"/>	<input type="checkbox"/>	
3							<input type="checkbox"/>	<input type="checkbox"/>	
4	VAR_INPUT	VAR1	BOOL				<input type="checkbox"/>	<input type="checkbox"/>	
5	VAR_OUTPUT	VAR2	BOOL				<input type="checkbox"/>	<input type="checkbox"/>	
6	VAR_EXTERNAL	p0	BOOL		%MX0		<input type="checkbox"/>	<input type="checkbox"/>	

Notes

- If no cell is selected, one line will be added to the first line
- If Enter key or Tab key is selected at the last of the lines, a new line will be created.



## Chapter 4 Variable

### 4.6.4 Delete line

It is used to delete the lines as many as the lines of the selected area.

[Steps]

1. Select the area to delete the lines from
2. Select [Edit] - [Delete Line] on the menu

The image shows two screenshots of the 'aaa[Local Variables]' dialog box. The top screenshot shows a table with 6 rows. Row 2 is selected. Below the table is a diagram with two lines: 'BOOL - EN ENO - BOOL' and 'BOOL - VAR1 VAR2 - BOOL'. The bottom screenshot shows the same dialog box, but row 2 is no longer selected, and the 'Variable Kind' dropdown menu is open, showing 'VAR' selected. The diagram below is identical to the top screenshot.

	Variable Kind	Variable Name	Type	Trigger	Memory Address	Initial Value	Retain	Used	Comment
1	VAR	VAR0	BOOL				<input type="checkbox"/>	<input type="checkbox"/>	
2							<input type="checkbox"/>	<input type="checkbox"/>	
3							<input type="checkbox"/>	<input type="checkbox"/>	
4	VAR_INPUT	VAR1	BOOL				<input type="checkbox"/>	<input type="checkbox"/>	
5	VAR_OUTPUT	VAR2	BOOL				<input type="checkbox"/>	<input type="checkbox"/>	
6	VAR_EXTERNAL	p0	BOOL		%MX0		<input type="checkbox"/>	<input type="checkbox"/>	

BOOL - EN ENO - BOOL  
BOOL - VAR1 VAR2 - BOOL

	Variable Kind	Variable Name	Type	Trigger	Memory Address	Initial Value	Retain	Used	Comment
1	VAR	VAR0	BOOL				<input type="checkbox"/>	<input type="checkbox"/>	
2	VAR_INPUT	VAR1	BOOL				<input type="checkbox"/>	<input type="checkbox"/>	
3	VAR_OUTPUT	VAR2	BOOL				<input type="checkbox"/>	<input type="checkbox"/>	
4	VAR_EXTERNAL	p0	BOOL		%MX0		<input type="checkbox"/>	<input type="checkbox"/>	

BOOL - EN ENO - BOOL  
BOOL - VAR1 VAR2 - BOOL

Notes

- If no cell is selected, [Delete Line] will not be executed.

4.6.5 Automatic fill

It is used to increase or decrease variables and direct variables to add on the list of variables/comments.

[Steps]

- 1. Move the mouse to the end of the cell and the mouse cursor will change to + shape
- 2. Move the mouse upward and downward with its left button being pressed.

The screenshot shows a software window titled 'aaa[Local Variables]'. At the top is a table with the following columns: Variable Kind, Variable Name, Type, Trigger, Memory Address, Initial Value, Retain, Used, and Comment. The first row contains 'VAR' in the Variable Kind column and 'VAR0' in the Variable Name column. A mouse cursor is positioned at the end of the 'VAR0' cell. Eight arrows labeled 'a' through 'h' point to various parts of the window: 'a' points to the Variable Kind dropdown, 'b' to the Variable Name text, 'c' to the end of the Variable Name cell, 'd' to the Trigger column, 'e' to the Initial Value column, 'f' to the Retain checkbox, 'g' to the Used checkbox, and 'h' to the Comment column. Below the table is a scrollable area containing a diagram of a logic element. The diagram shows a rectangular box with 'EN' on the left side and 'ENO' on the right side. Two lines labeled 'BOOL' extend from the 'EN' and 'ENO' ports respectively.

# Chapter 4 Variable

aaa[Local Variables]

	Variable Kind	Variable Name	Type	Trigger	Memory Address	Initial Value	Retain	Used	Comment
1	VAR	VAR0					<input type="checkbox"/>	<input type="checkbox"/>	
2							<input type="checkbox"/>	<input type="checkbox"/>	
3							<input type="checkbox"/>	<input type="checkbox"/>	
4							<input type="checkbox"/>	<input type="checkbox"/>	

aaa[Local Variables]

	Variable Kind	Variable Name	Type	Trigger	Memory Address	Initial Value	Retain	Used	Comment
1	VAR	VAR0					<input type="checkbox"/>	<input type="checkbox"/>	
2	VAR	VAR1					<input type="checkbox"/>	<input type="checkbox"/>	
3	VAR	VAR2					<input type="checkbox"/>	<input type="checkbox"/>	
4	VAR	VAR3					<input type="checkbox"/>	<input type="checkbox"/>	

### [Details]

- a. Variable Kind: the value is filled in a cell as copied.
- b. Variable Name: it always executes Automatic Fill because a variable can not be declared in duplicate. If it contains a number, it automatically increases. If not, it adds a number at the end and counts it automatically.
- c. Type: it is filled in a cell as copied.
- d. Trigger: trigger is filled in a cell as copied.
- e. Memory address: it can not be declared as Read Only.
- f. Initial value: it is filled in a cell as copied.
- g. Retain: it can not be declared as Read Only.
- h. Used: it can not be declared as Read Only.
- i. Comment: a number is automatically increased if automatic fill is executed with Ctrl pressed; if not, it is copied.

### Notes

- If any error occurs when editing a cell, it is displayed in pink.
- Press ESC key to recover the previous value during the cell edit.

### 4.6.6 Drag & Drop

It is used to copy the selected items to paste on different positions.

### [Steps]

1. Select the area to drag and drop.
2. The mouse cursor will change to the state available for drag and drop.
3. With the left mouse button being pressed, drag and drop the selected items onto a position to paste on.

# Chapter 4 Variable

aaa[Local Variables]

	Variable Kind	Variable Name	Type	Trigger	Memory Address	Initial Value	Retain	Used	Comment
1	VAR	VAR0					<input type="checkbox"/>	<input type="checkbox"/>	
2	VAR	VAR1					<input type="checkbox"/>	<input type="checkbox"/>	
3	VAR	VAR2					<input type="checkbox"/>	<input type="checkbox"/>	
4	VAR	VAR3					<input type="checkbox"/>	<input type="checkbox"/>	

Diagram: A rectangular coil with 'EN' on the left and 'ENO' on the right. A line connects 'ENO' to the text 'BOOL' on the right.

aaa[Local Variables]

	Variable Kind	Variable Name	Type	Trigger	Memory Address	Initial Value	Retain	Used	Comment
1	VAR	VAR0					<input type="checkbox"/>	<input type="checkbox"/>	
2	VAR	VAR1					<input type="checkbox"/>	<input type="checkbox"/>	
3	VAR	VAR2					<input type="checkbox"/>	<input type="checkbox"/>	
4	VAR	VAR3					<input type="checkbox"/>	<input type="checkbox"/>	

Diagram: A rectangular coil with 'EN' on the left and 'ENO' on the right. A line connects 'ENO' to the text 'BOOL' on the right.

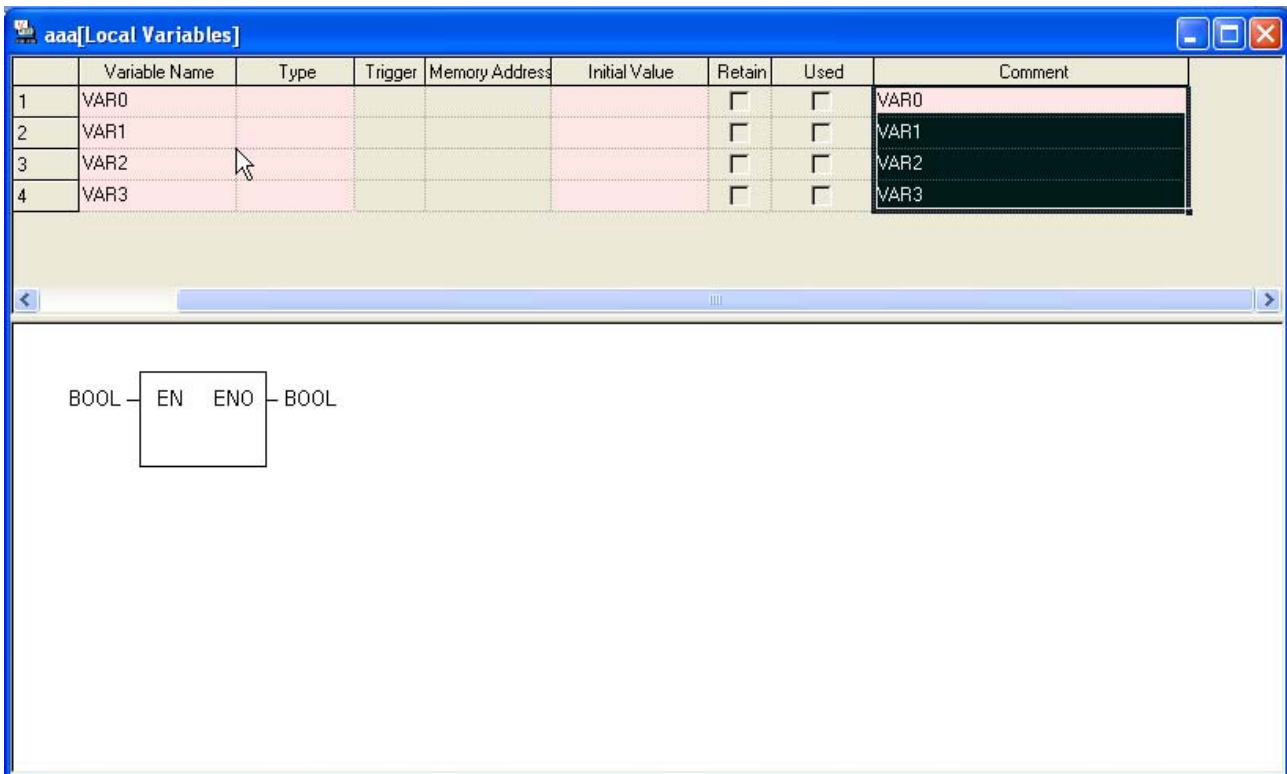

[Details]

- a. Drag and drop is available onto Variable Monitoring Window.
- b. Drag and drop is available onto LD Window.
- c. Copy is available when drag and drop is executed onto Excel program.
- d. Drag and drop is available onto local variable of other XG5000 programs.

**Notes**

- Data is not moved but just copied always when dragged and dropped.
- Paste is not available in Flag.

**4.6.7 Undo/Redo**

Undo is used to cancel the edited detail in order to return to its previous state. Redo cancels again the operation of Edit Cancel.

[Details]

- 1. Undo/Redo is available for Cell Edit.
- 2. Undo/Redo is available for Change.
- 3. Undo/Redo is available for All Change.

## Chapter 4 Variable

4. Undo/Redo is available for Delete.
5. Undo/Redo is available for Cut.
6. Undo/Redo is available for Paste.
7. Undo/Redo is available for Automatic Fill.
8. Undo/Redo is available for Insert Line. (Only in Global Variable)
9. Undo/Redo is available for Delete Line. (Only in Global Variable)
10. Undo/Redo is available for drag and drop.
11. Undo/Redo is available for Align. (Only in Global Variable).
12. If External variable is added, it executes Undo/Redo.
13. Undo/Redo is available for above the items.
14. Undo/Redo is available for below the items.

### 4.6.8 Export to file

It is used to save the previously declared list of global variables on the file and to open and read in the external programs.

[Steps]

1. Select [Edit] - [Export to File] on the menu

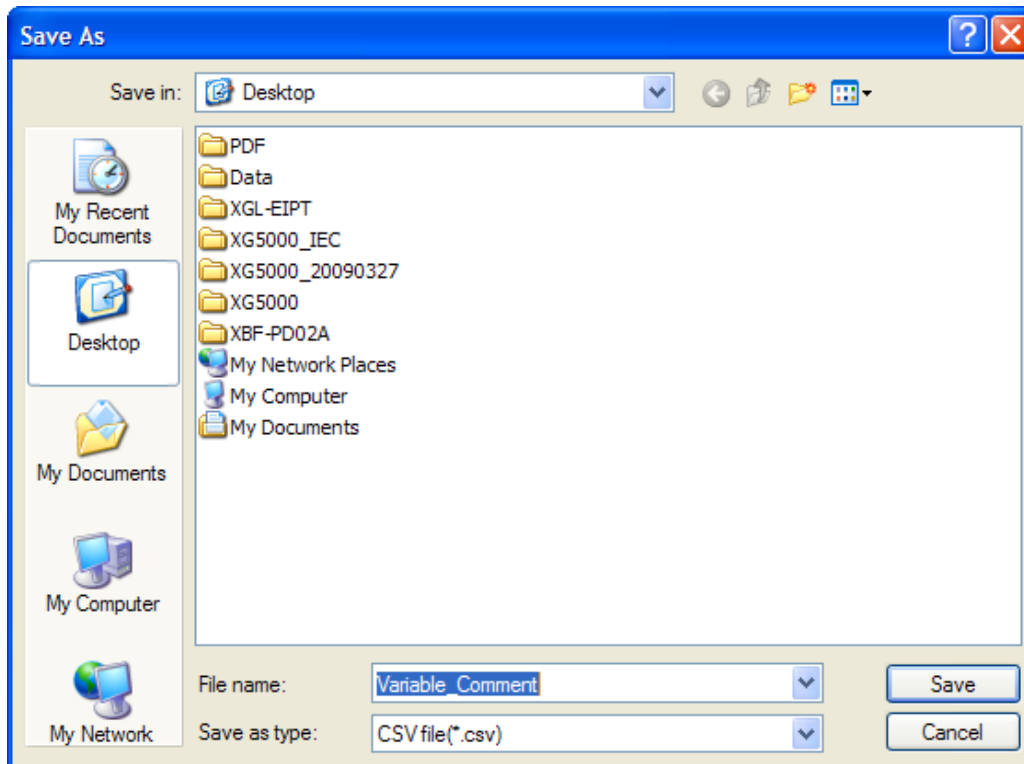

If you press 'Save', file is saved as inputted file name at selected folder location.

If you press 'Cancel', file is not created and dialog box is closed

File is classified by tap.

### 4.6.9 Add EXTERNAL Variable

The list created by Global Variable can be loaded by Add External Variable.

[Steps]

1. Select [Edit]-[Add EXTERNAL Variable] on the menu
2. Global Variable Selection Dialog Box will be called.

[Dialog box]

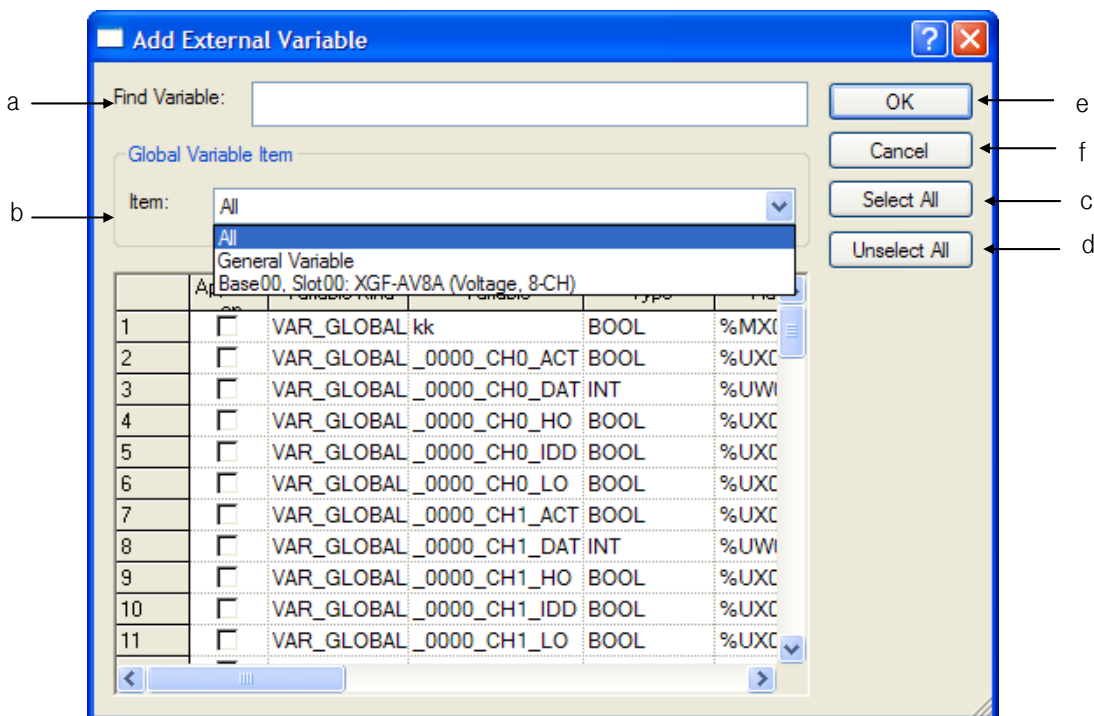

[Description of dialog box]

- a. Find Variable: finds variable meeting the condition at information of Global Variable Item
- b. Global Variable item: at declared global variable item, displays items according to item types. All, general variable, special module - related variable
- c. Select All: selects all application column at global variable item
- d. Unselect All: unselects all application columns at global variable item
- e. OK: Closes dialog box and registers global variable as External variable.
- f. Cancel: closes dialog box and doesn't register the selected variable as External variable



## Chapter 4 Variable

[Global variable item – All]

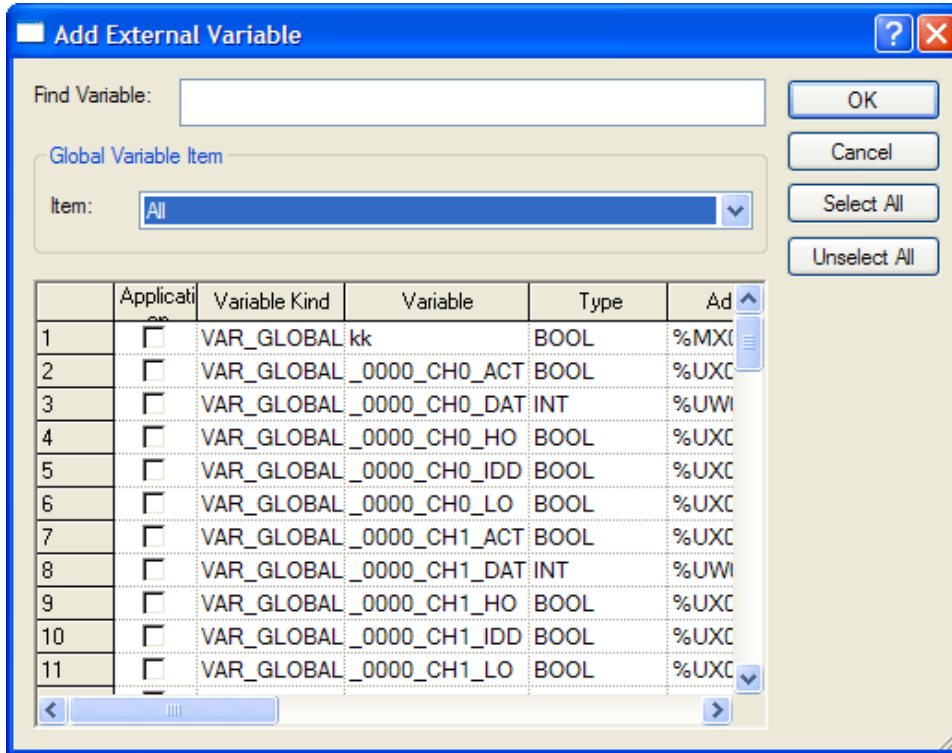

[Global variable item – General Variable]

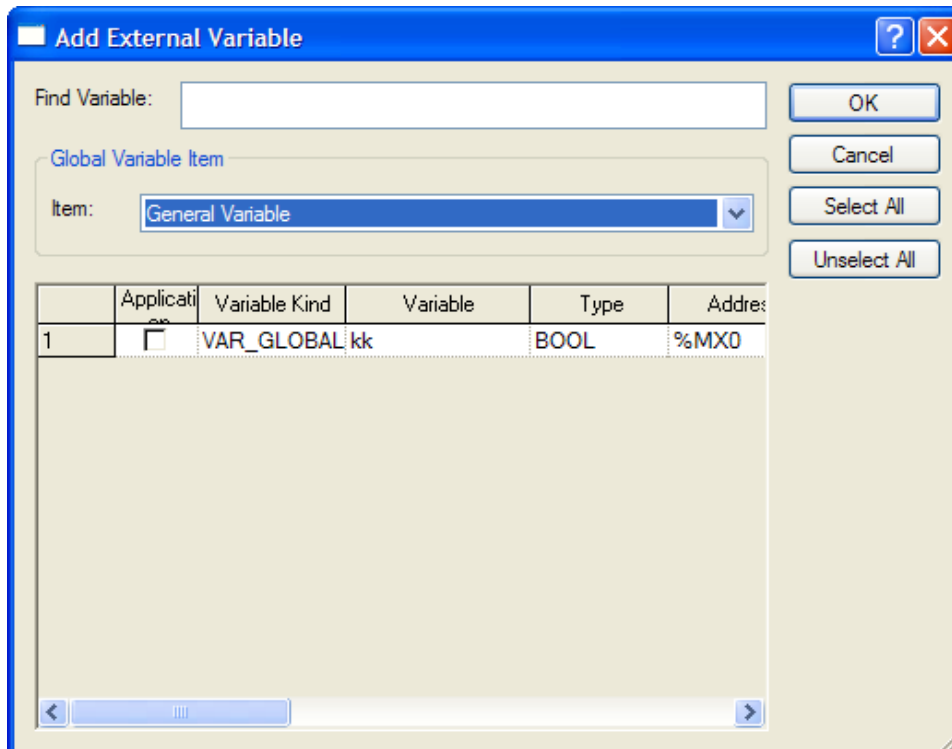

[Global variable item – special module related variable]

**Add External Variable**

Find Variable:

Global Variable Item

Item:

	Applicati	Variable Kind	Variable	Type	Ad
1	<input type="checkbox"/>	VAR_GLOBAL	_0000_CH0_ACT	BOOL	%UXC
2	<input type="checkbox"/>	VAR_GLOBAL	_0000_CH0_DAT	INT	%UWI
3	<input type="checkbox"/>	VAR_GLOBAL	_0000_CH0_HO	BOOL	%UXC
4	<input type="checkbox"/>	VAR_GLOBAL	_0000_CH0_IDD	BOOL	%UXC
5	<input type="checkbox"/>	VAR_GLOBAL	_0000_CH0_LO	BOOL	%UXC
6	<input type="checkbox"/>	VAR_GLOBAL	_0000_CH1_ACT	BOOL	%UXC
7	<input type="checkbox"/>	VAR_GLOBAL	_0000_CH1_DAT	INT	%UWI
8	<input type="checkbox"/>	VAR_GLOBAL	_0000_CH1_HO	BOOL	%UXC
9	<input type="checkbox"/>	VAR_GLOBAL	_0000_CH1_IDD	BOOL	%UXC
10	<input type="checkbox"/>	VAR_GLOBAL	_0000_CH1_LO	BOOL	%UXC
11	<input type="checkbox"/>	VAR_GLOBAL	_0000_CH2_ACT	BOOL	%UXC

Buttons: OK, Cancel, Select All, Unselect All

## 4.7 FUN Variable

FUN Variable does not memorize the operation results such as 4 arithmetic operations and comparative operations and declares the variable of operation unit using the operation results or displays the list of declared variables, based on the variable.

### 4.7.1 FUN Variable

It declares the variable and displays the list of declared FUN variables

The screenshot shows a software window titled 'aaa[Local Variables]'. It contains a table with the following data:

	Variable Kind	Variable Name	Type	Trigger	Memory Address	Initial Value	Retain	Used	Comment
1	VAR_INPUT	TEST1	BOOL				<input type="checkbox"/>	<input type="checkbox"/>	
2	VAR	TEST2	BOOL				<input type="checkbox"/>	<input type="checkbox"/>	
3	VAR_INPUT	TEST3	BOOL				<input type="checkbox"/>	<input type="checkbox"/>	
4	VAR	TEST4	BOOL				<input type="checkbox"/>	<input type="checkbox"/>	
5	VAR_OUTPUT	TEST5	BOOL				<input type="checkbox"/>	<input type="checkbox"/>	

Below the table is a logic diagram showing a box with three inputs and two outputs:

- Input 1: EN (BOOL)
- Input 2: TEST<sub>1</sub> (BOOL)
- Input 3: TEST<sub>3</sub> (BOOL)
- Output 1: ENO (BOOL)
- Output 2: TEST<sub>5</sub> (BOOL)

## 4.8 FUN Variable Edit

On the list of the presently declared FUN variables, variable kind, variable name, type, trigger, memory address, initial value, retain, used and comment items can be edited. In addition, a new FUN variable can be added to the list of the FUN variables.

### 4.8.1 FUN Variable Registration

This is used to register FUN variables to use in the program. In order to register on the list of FUN variables, go through FUN variable.

#### 1) Register in FUN Variable

A variable can be added to the list of FUN variables, modified or deleted from it.

[Dialog Box]

The dialog box 'aaa[Local Variables]' contains the following table:

	Variable Kind	Variable Name	Type	Trigger	Memory Address	Initial Value	Retain	Used	Comment
1	VAR_INPUT	TEST1	BOOL				<input type="checkbox"/>	<input type="checkbox"/>	
2	VAR	TEST2	BOOL				<input type="checkbox"/>	<input type="checkbox"/>	
3	VAR_INPUT	TEST3	BOOL				<input type="checkbox"/>	<input type="checkbox"/>	
4	VAR	TEST4	BOOL				<input type="checkbox"/>	<input type="checkbox"/>	
5	VAR_OUTPUT	TEST5	BOOL				<input type="checkbox"/>	<input type="checkbox"/>	

Below the table, a diagram shows a box with the following connections:

- Input: EN (BOOL)
- Output: ENO (BOOL)
- Input: TEST<sub>1</sub> (BOOL)
- Output: TEST<sub>5</sub> (BOOL)
- Input: TEST<sub>3</sub> (BOOL)
- Output: TEST<sub>3</sub> (BOOL)

## Chapter 4 Variable

- a. Variable Kind: VAR, VAR\_INPUT, VAR\_OUTPUT, VAR\_IN\_OUT and VAR\_RETURN are available.
- b. Variable name: The declared variable can not be duplicated with the identical name.
  - A figure is unavailable for the first character.
  - A special character is unavailable. (However, '\_' is available.)
  - Space is not available as a character.
  - A name same with direct variable can not be used as a name(i.e. MB4, W4, RW9,...)
  - If a line is empty, BOOL is displayed as the default type when entering a variable.
- c. Type: 22 types are available; 20 basic types and 3 induced types.
  - Basic types(20): (BOOL, BYTE, WORD, DWORD, LWORD, SINT, INT, DINT, LINT, USINT, UINT, UDINT, ULINT, REAL, LREAL, TIME, DATE, TIME\_OF\_DAY, DATE\_AND\_TIME, STRING)
  - Induced types(2): ARRAY(i.e. ARRAY[0..6,0..2,0..4] OF BOOL) => factor limit (up to 3rd), STRUCT(i.e. STRUCT name display) => STRUCT type is no available in STRCT
- d. Used: it can not be declared as Read Only.
- e. Comment: every character is available.
  - Multi line entry is available by using Ctrl + Enter key.
- f. Line validity: To register on FB variable window, it needs variable type, variable and type.
  - If not registered on FB variable, it displays in pink.

### Notes

- If any error occurs when editing a cell, it is displayed in pink.
- Press ESC key to recover the previous value during the cell edit.

## 4.8.2 Copy, Cut, Delete and Paste

Copy, cut, delete or paste can be executed to edit the list of local variables used in the program.

### 1) Copy

It is used to save the data of the area selected to copy in the clipboard. The copied details can be added to the present project or other projects. Paste on other applications is also available.

[Steps]

1. Select the area to copy.
2. Select [Edit] - [Copy] on the menu.

#### Notes

- How to select the area is as follows;
- Use the mouse to select the cell of (0,0) in order to select the whole table
- Select [Edit] - [Select All] in order to select the whole table.
- Use the mouse to select the column header of the cell in order to select the whole columns.
- Use the mouse to select the row header of the cell in order to select the whole rows.
- Use the mouse to drag the part of the cell in order to select the area.
- Use Shift + Arrow keys on the keyboard in order to select the area

### 2) Delete

It is used to delete the data of the selected area from the list of local variables.

[Steps]

1. Select the area to delete.
2. Select [Edit] - [Delete] on the menu.

### 3) Cut

It is used to save the selected data in the clipboard in order to add to the present project or other projects. Besides, it will delete the selected data.

[Steps]

1. Select the area to cut.
2. Select [Edit]-[Cut] on the menu.

## Chapter 4 Variable

### 4) Paste

It displays the data saved in the clipboard on the selected position. If the data is already displayed, the Dialog Box will be called to select and change the data.

\* If the data saved in the clipboard is a part of columns,

[Steps]

1. Select the position to paste on.
2. Select [Edit]-[Paste] on the menu.
3. If the variable and direct variable are identical on the list of variables/comments, the dialog box will be called.

[Dialog Box]

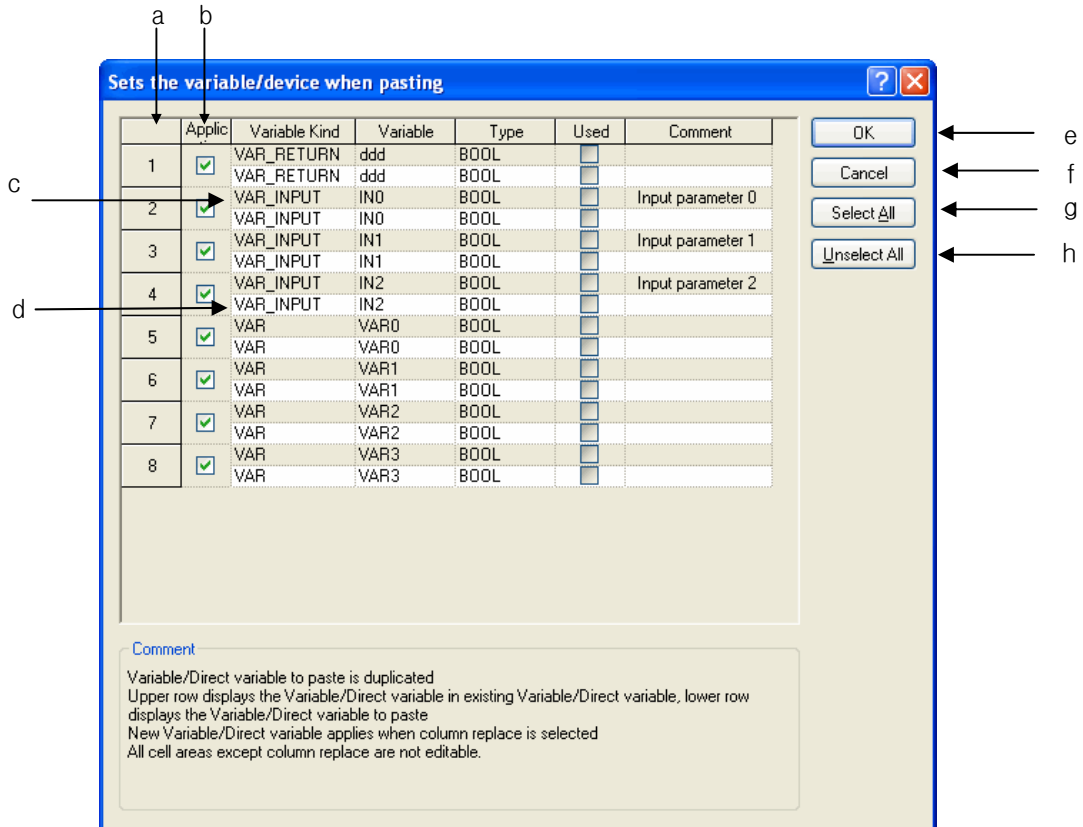

[Comment of Dialog Box]

- a. Number: used to display the duplicated number of the variables and direct variables to paste.
- b. Replace: used to apply Paste.
- c. Gray Line: used to display the existing list of variables/comments, which will not be edited.
- d. White Line: used to display the list of variables/comments obtained from the clipboard, which will not be edited.
- e. OK: applies the lines of the selected check box. The existing list of variables/comments will be deleted to add a new list of variables/comments.
- f. Cancel: The existing list of variables/comments will not be deleted, and a new the list of variables/comments will not be applied accordingly.
- g. Select All: used to check all the check boxes in the [Replace] column.
- h. Unselect All: used to cancel all the selected check boxes in the [Replace] column.

\* If the data saved in the clipboard is of the partial column,

[Steps]

1. Select the position to paste on.
2. Select [Edit] – [Paste] on the menu.
3. If the variable and direct variable are identical on the list of variables/comments, the dialog box will be called.

[Dialog Box]

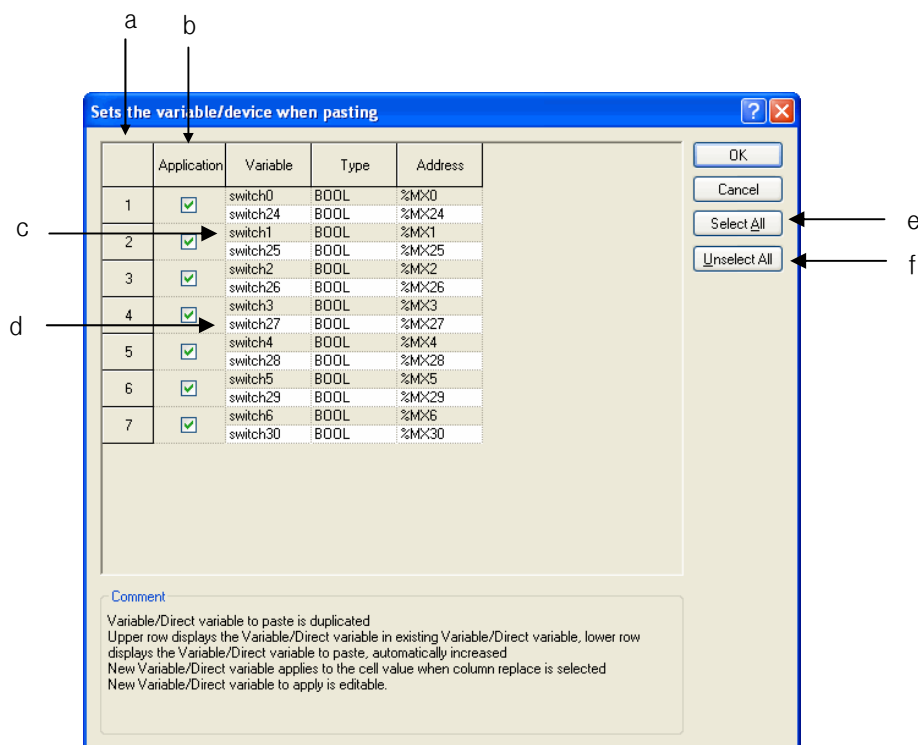



## Chapter 4 Variable

[Description of Dialog Box]

- a. Number: used to display the duplicated number of the variables and direct variables to paste.
- b. Application: used to apply Paste.
- c. Gray Line: used to display the data in the existing cell, which will not be edited.
- d. White Line: If the variable or device of the data to paste is duplicated, it will be automatically increased and then displayed on the screen. In addition, the cell can be edited.
- e. Select All: used to check all the check boxes in the [Replace] column.
- f. Unselect All: used to cancel all the selected check boxes in the [Replace] column.

### Notes

- If all items are identical, the cell can not be edited, while if partially identical, the cell can be edited.
- If the number of the columns saved in the clipboard is greater than the number of the columns to paste, it is not possible to paste.
- If the data saved in the clipboard is greater than the number of the lines to paste, it is not possible to paste.

### 4.8.3 Insert line

It is used to insert new lines as many as the lines of the selected area, which will make the existing lines move downward.

[Steps]

1. Select the area to insert the lines into
2. Select [Edit] - [Insert Line] on the menu

The screenshot shows a software window titled 'aaa[Local Variables]'. It contains a table with the following data:

	Variable Kind	Variable Name	Type	Trigger	Memory Address	Initial Value	Retain	Used	Comment
1	VAR_INPUT	TEST1	BOOL				<input type="checkbox"/>	<input type="checkbox"/>	
2	VAR_INPUT	TEST3	BOOL				<input type="checkbox"/>	<input type="checkbox"/>	
3	VAR_OUTPUT	TEST5	BOOL				<input type="checkbox"/>	<input type="checkbox"/>	
4	VAR	TEST2	BOOL				<input type="checkbox"/>	<input type="checkbox"/>	
5	VAR	TEST4	BOOL				<input type="checkbox"/>	<input type="checkbox"/>	
6							<input type="checkbox"/>	<input type="checkbox"/>	

Below the table is a scrollable area containing a ladder logic diagram. The diagram shows three normally open contacts labeled 'EN', 'TEST1', and 'TEST3' connected in series to a coil labeled 'ENO'. The coil is connected to a power rail labeled 'BOO'. The contacts are also labeled with their respective variable names: 'EN', 'TEST 1', and 'TEST 3'.

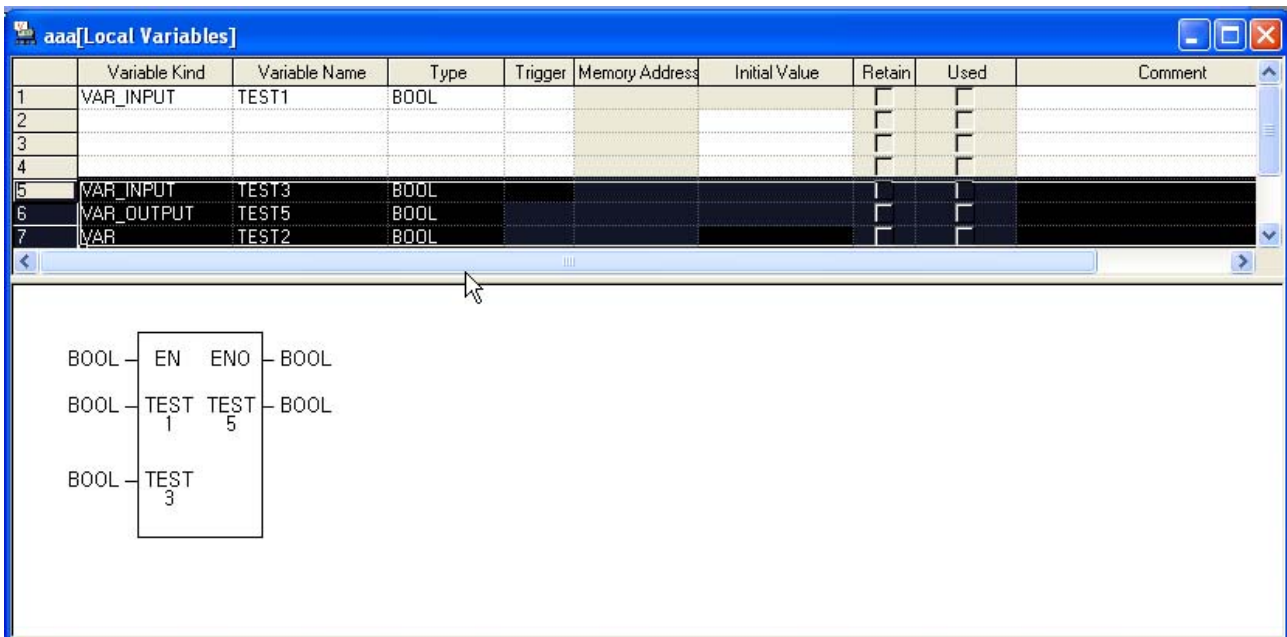

**Notes**

- If no cell is selected, one line will be added to the first line.
- If Enter key or Tab key is selected at the last of the lines, a new line will be created.

**4.8.4 Delete line**

It is used to delete the lines as many as the lines of the selected area,

[Steps]

1. Select the area to delete the lines from.
2. Select [Edit] - [Delete Line] on the menu.

## Chapter 4 Variable

aaa[Local Variables]

	Variable Kind	Variable Name	Type	Trigger	Memory Address	Initial Value	Retain	Used	Comment
1	VAR_INPUT	TEST1	BOOL				<input type="checkbox"/>	<input type="checkbox"/>	
2							<input type="checkbox"/>	<input type="checkbox"/>	
3							<input type="checkbox"/>	<input type="checkbox"/>	
4							<input type="checkbox"/>	<input type="checkbox"/>	
5	VAR_INPUT	TEST3	BOOL				<input type="checkbox"/>	<input type="checkbox"/>	
6	VAR_OUTPUT	TEST5	BOOL				<input type="checkbox"/>	<input type="checkbox"/>	
7	VAR	TEST2	BOOL				<input type="checkbox"/>	<input type="checkbox"/>	

aaa[Local Variables]

	Variable Kind	Variable Name	Type	Trigger	Memory Address	Initial Value	Retain	Used	Comment
1	VAR_INPUT	TEST1	BOOL				<input type="checkbox"/>	<input type="checkbox"/>	
2	VAR_INPUT	TEST3	BOOL				<input type="checkbox"/>	<input type="checkbox"/>	
3	VAR_OUTPUT	TEST5	BOOL				<input type="checkbox"/>	<input type="checkbox"/>	
4	VAR	TEST2	BOOL				<input type="checkbox"/>	<input type="checkbox"/>	
5	VAR	TEST4	BOOL				<input type="checkbox"/>	<input type="checkbox"/>	
6							<input type="checkbox"/>	<input type="checkbox"/>	

### Notes

- If no cell is selected, [Delete Line] will not be executed.

### 4.8.5 Automatic fill

It is used to increase or decrease variables and direct variables to add on the list of variables/comments.

[Steps]

1. Move the mouse to the end of the cell and the mouse cursor will change to + shape.
2. Move the mouse upward and downward with its left button being pressed.

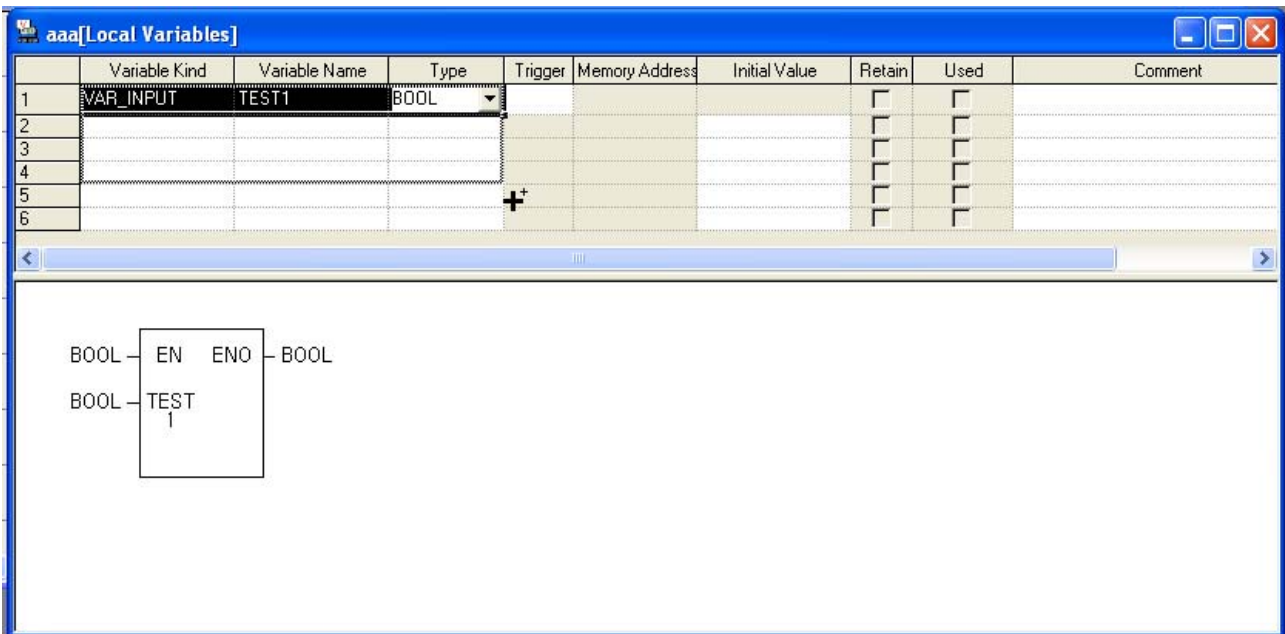
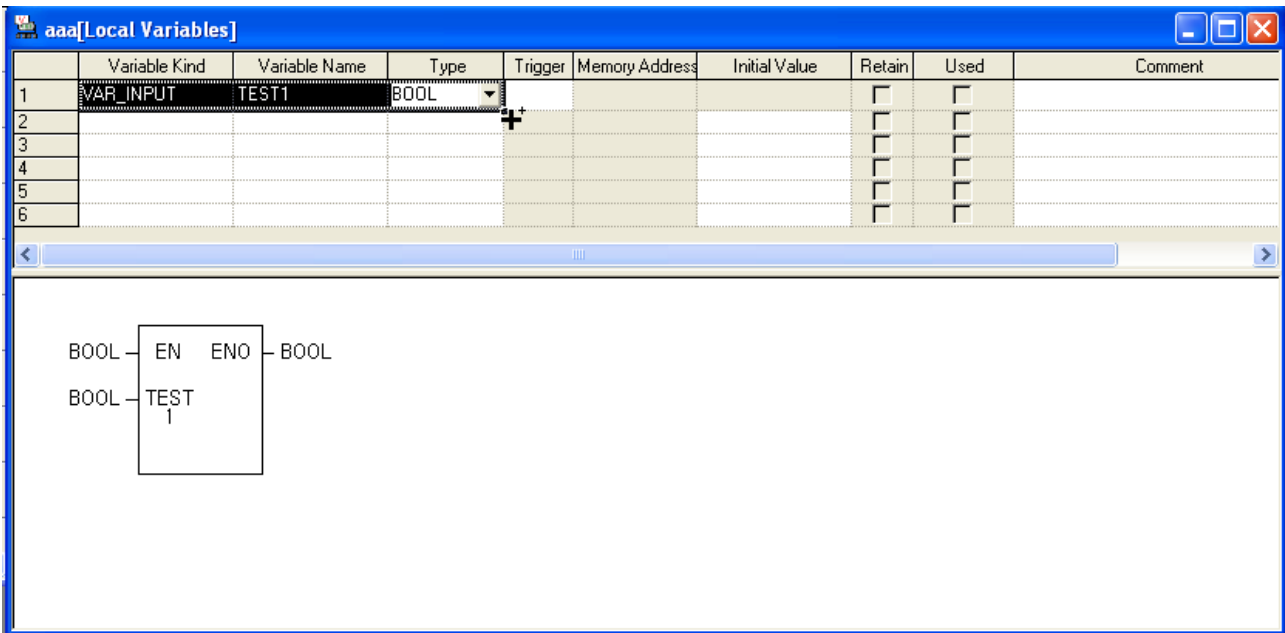

## Chapter 4 Variable

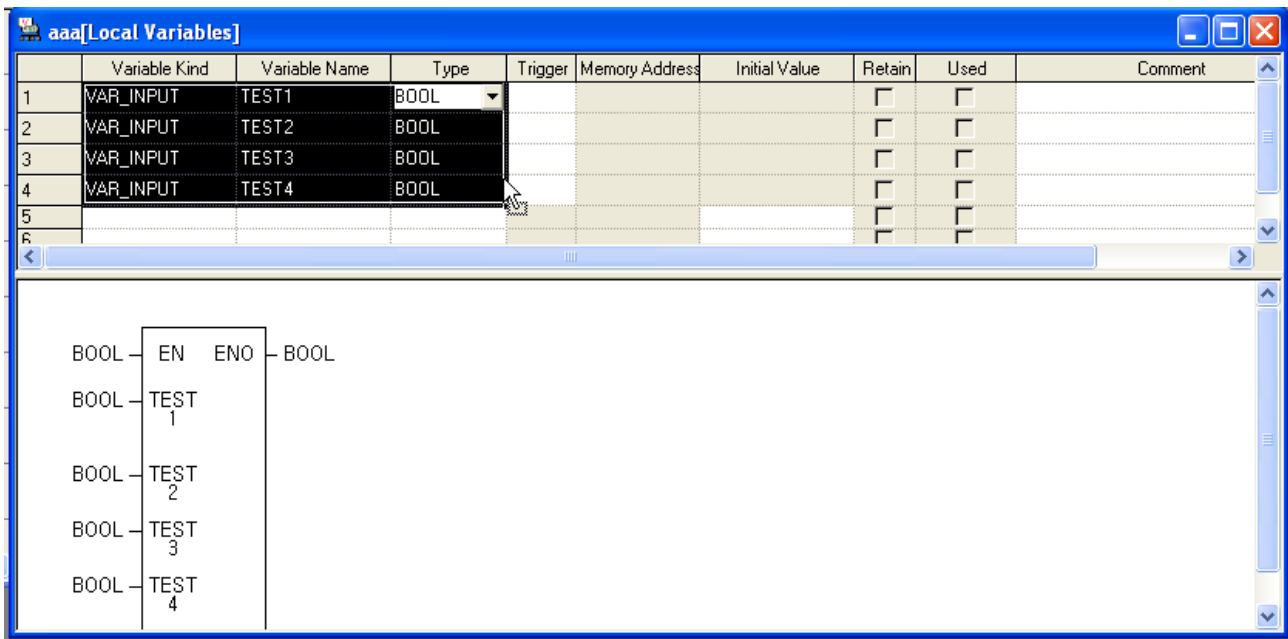

### [Details]

- b. Variable Kind: the value is filled in a cell as copied.
- c. Variable Name: it always executes Automatic Fill because a variable can not be declared in duplicate. If it contains a number, it automatically increases. If not, it adds a number at the end and counts it automatically.
- d. Type: it is filled in a cell as copied
- e. Trigger: trigger is filled in a cell as copied.
- f. Used: it can not be declared as Read Only.
- g. Comment: a number is automatically increased if automatic fill is executed with Ctrl pressed; if not, it is copied.

### Notes

- If any error occurs when editing a cell, it is displayed in pink.
- Press ESC key to recover the previous value during the cell edit.

### 4.8.6 Drag & Drop

It is used to copy the selected items to paste on different positions.

[Steps]

1. Select the area to drag and drop.
2. The mouse cursor will change to the state available for drag and drop.
3. With the left mouse button being pressed, drag and drop the selected items onto a position to paste on.

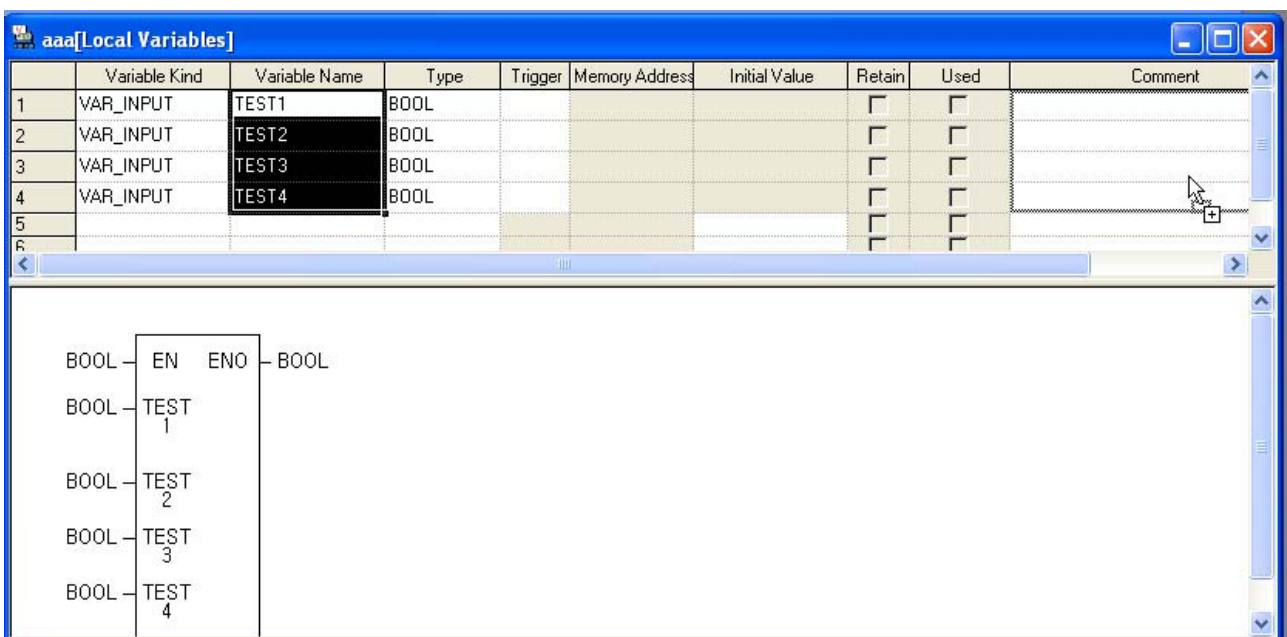
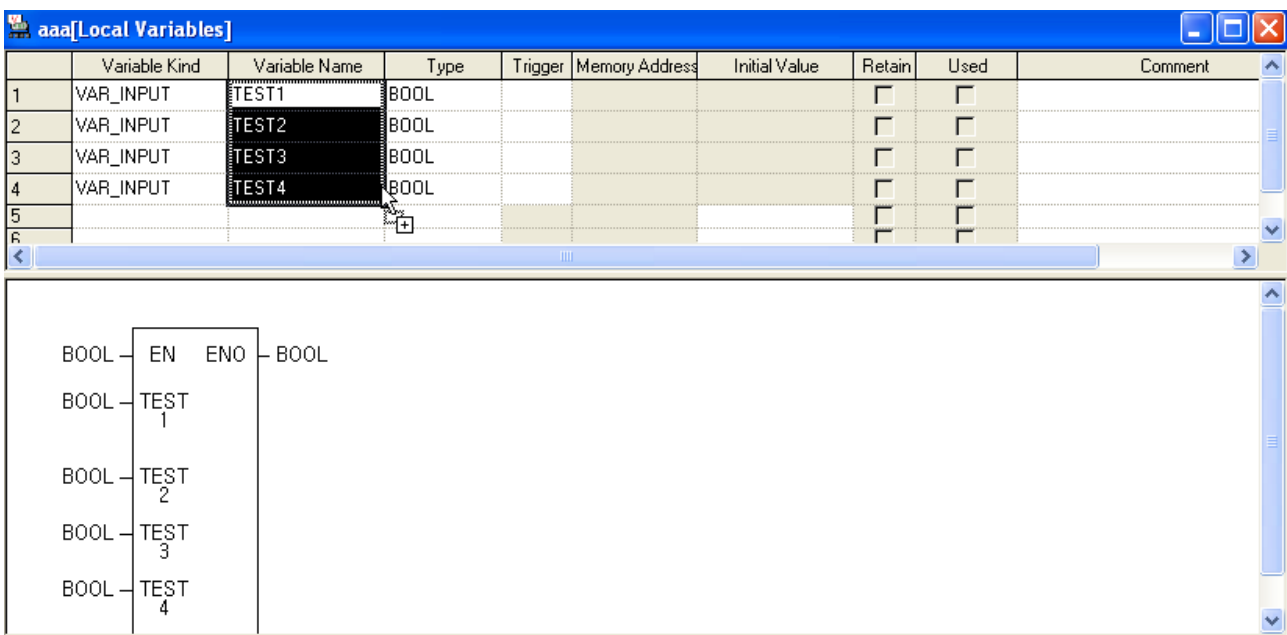

## Chapter 4 Variable

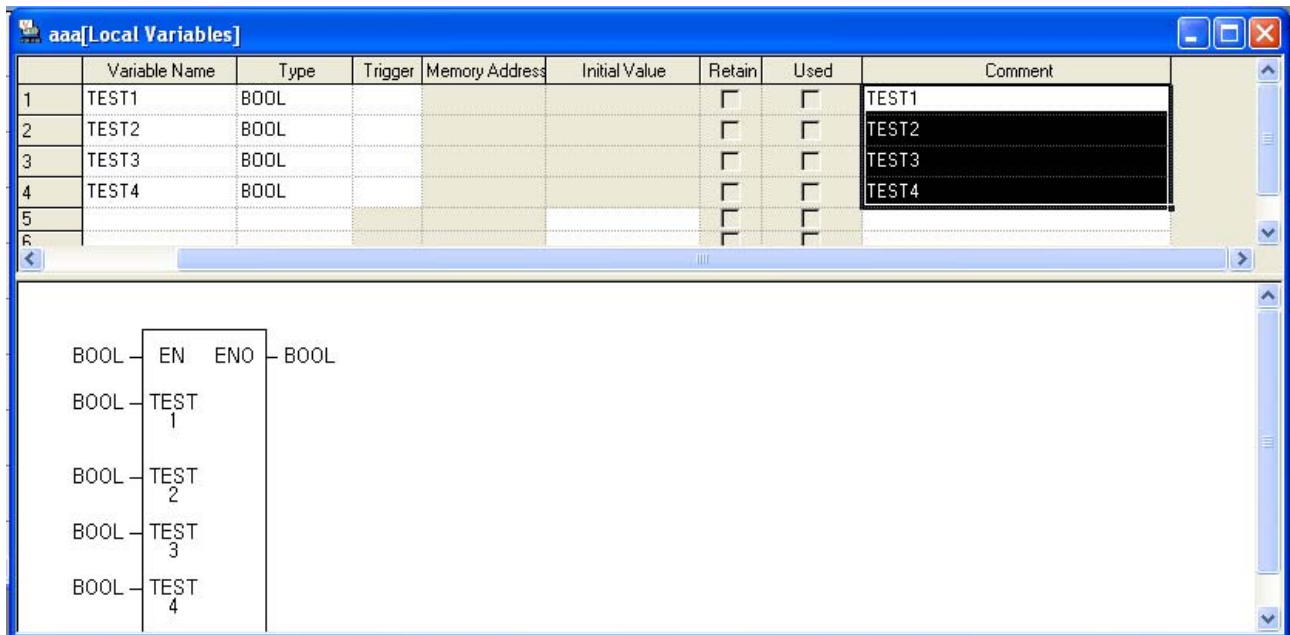

### [Details]

- Drag and drop is available onto Variable Monitoring Window.
- Drag and drop is available onto LD Window.
- Copy is available when drag and drop is executed onto Excel program.
- Drag and drop is available onto FB Variable of other XG5000 programs.

### Notes

- Data is not moved but just copied always when dragged and dropped.

### 4.8.7 Undo/Redo

Undo is used to cancel the edited detail in order to return to its previous state. Redo cancels again the operation of Edit Cancel.

[Details]

1. Undo/Redo is available for Cell Edit.
2. Undo/Redo is available for Change.
3. Undo/Redo is available for All Change.
4. Undo/Redo is available for Delete.
5. Undo/Redo is available for Cut.
6. Undo/Redo is available for Paste.
7. Undo/Redo is available for Automatic Fill.
8. Undo/Redo is available for Insert Line. (Only in Global Variable)
9. Undo/Redo is available for Delete Line. (Only in Global Variable)
10. Undo/Redo is available for drag and drop.
11. Undo/Redo is available for Align.
12. Undo/Redo is executed above the item.
13. Undo/Redo is executed below the item.

### 4.8.8 Export to file

It is used to save the previously declared list of global variables on the file and to open and read in the external programs.

[Steps]



## Chapter 4 Variable

1. Select [Edit] - [Export to File] on the menu.

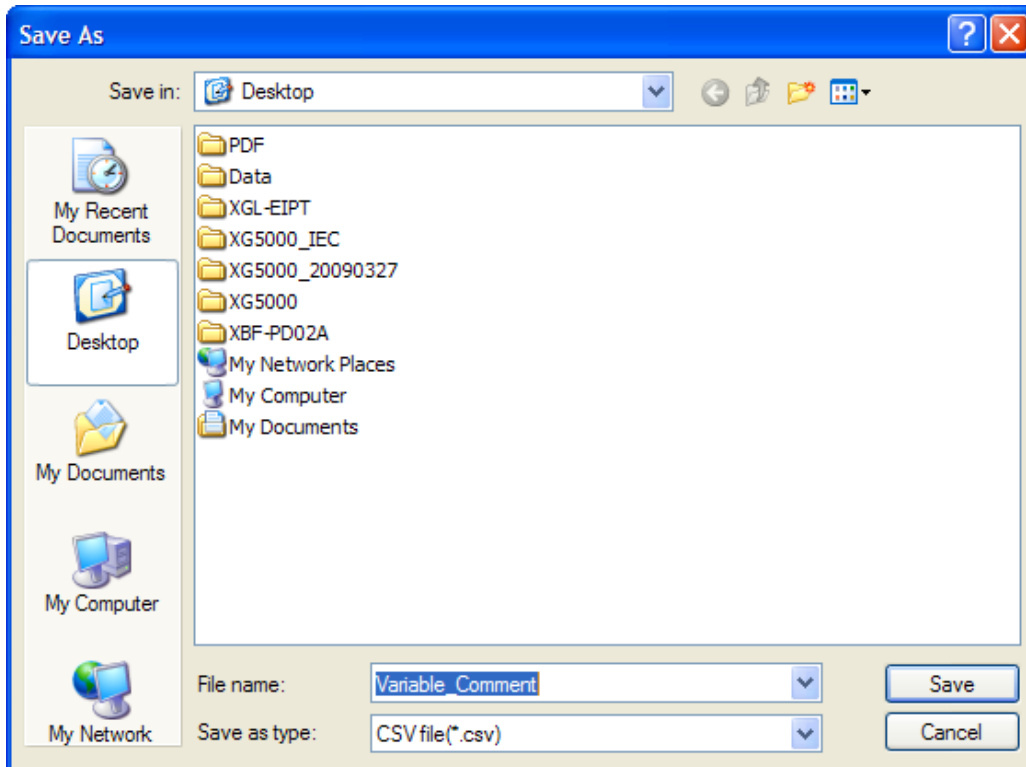

If you press 'Save', file is saved as inputted file name at selected folder location.

If you press 'Cancel', file is not created and dialog box is closed

File is classified by tap.

### 4.9 Data type edit

On the list of the presently declared data types, variable, type, memory allocation, initial value, retain and comment can be edited. In addition, it adds the data type used in the program to the list of data types.

#### 4.9.1 Data Type Registration

Register a data type to use in the program, In order to register on the list of data types, go through Data Type.

##### 1) Register in Data Type

A variable can be added to, modified or deleted from the list of data type.

[Dialog Box]

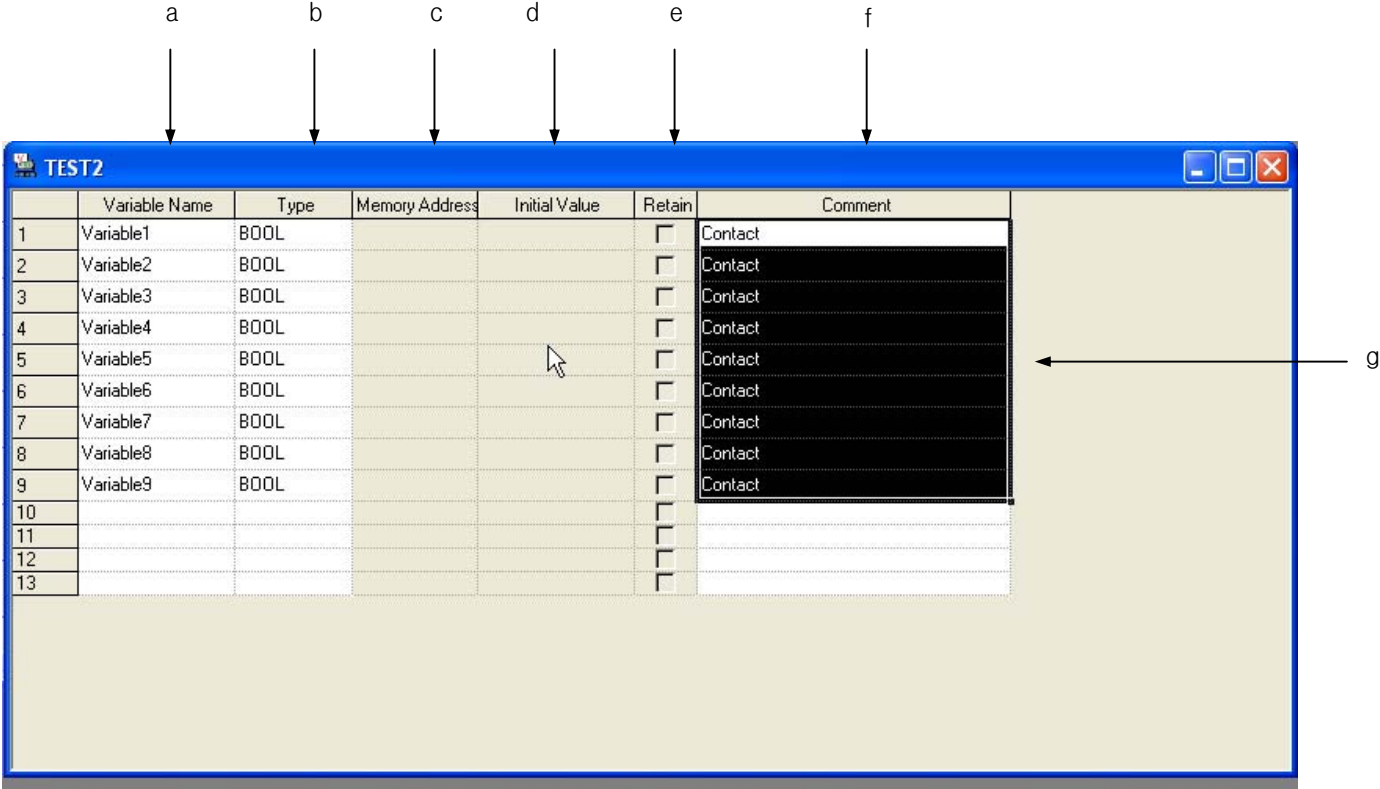

## Chapter 4 Variable

[Description of Dialog Box]

- a. Variable Name: The declared variable can not be duplicated with the identical name.
  - A figure is unavailable for the first character.
  - A special character is unavailable. (However, '\_' is available.)
  - Space is not available as a character.
  - A name same with direct variable can not be used as a name(i.e. MB4, W4, RW9,...)
  - If a line is empty, BOOL is displayed as the default type when entering a variable.
- b. Type: 21 types are available; 20 basic types and 1 induced types
  - Basic types (20): (BOOL, BYTE, WORD, DWORD, LWORD, SINT, INT, DINT, LINT, USINT, UINT, UDINT, ULINT, REAL, LREAL, TIME, DATE, TIME\_OF\_DAY, DATE\_AND\_TIME, STRING)
  - Induced types(1): ARRAY(i.e. ARRAY[0..6,0..2,0..4] OF BOOL) => factor limit (up to 3 rd)
- c. Memory address: Read Only.
- d. Initial Value: Read Only.
- e. Retain: Read Only.
- f. Comment: every character is available.
  - Multi line entry is available by using Ctrl + Enter key.

### Notes

- If any error occurs when editing a cell, it is displayed in pink.
- Press ESC key to recover the previous value during the cell edit.

## 4.9.2 Copy, Cut, Delete and Paste

Copy, cut, delete or paste can be executed to edit the list of local variables used in the program.

### 1) Copy

It is used to save the data of the area selected to copy in the clipboard. The copied details can be added to the present project or other projects. Paste on other applications is also available.

[Steps]

1. Select the area to copy
2. Select [Edit] - [Copy] on the menu

#### Notes

- How to select the area is as follows;
- Use the mouse to select the cell of (0,0) in order to select the whole table
- Select [Edit] - [Select All] in order to select the whole table.
- Use the mouse to select the column header of the cell in order to select the whole columns.
- Use the mouse to select the row header of the cell in order to select the whole rows.
- Use the mouse to drag the part of the cell in order to select the area.
- Use Shift + Arrow keys on the keyboard in order to select the area.

### 2) Delete

It is used to delete the data of the selected area from the list of local variables

[Steps]

1. Select the area to delete.
2. Select [Edit] - [Delete] on the menu.

### 3) Cut

It is used to save the selected data in the clipboard in order to add to the present project or other projects. Besides, it will delete the selected data.

[Steps]

1. Select the area to cut.
2. Select [Edit]-[Cut] on the menu.

## Chapter 4 Variable

### 4) Paste

It displays the data saved in the clipboard on the selected position. If the data is already displayed, the Dialog Box will be called to select and change the data

\* If the data saved in the clipboard is a part of columns,

[Steps]

1. Select the position to paste on.
2. Select [Edit]-[Paste] on the menu.
3. If the variable and direct variable are identical on the list of variables/comments, the dialog box will be called.

[Dialog Box]

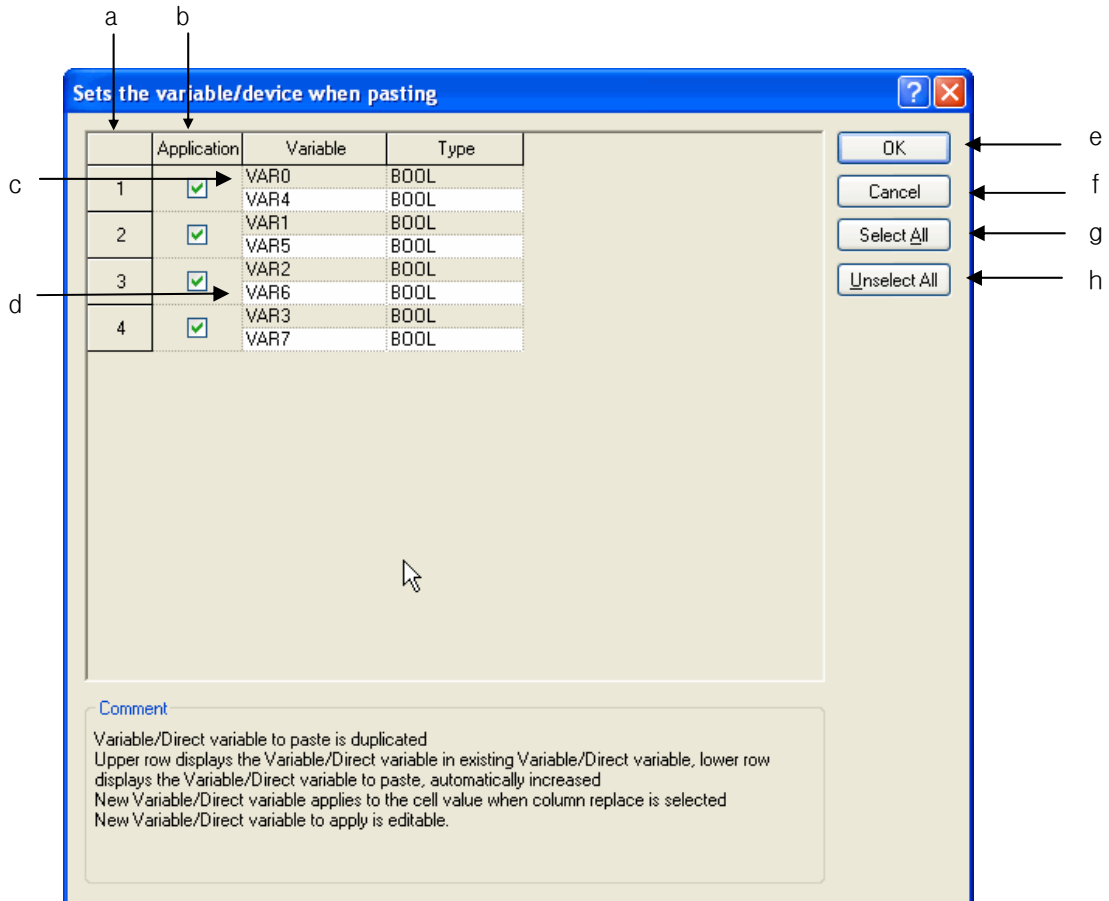

[Comment of Dialog Box]

- a. Number: used to display the duplicated number of the variables and direct variables to paste.
- b. Replace: used to apply Paste.
- c. Gray Line: used to display the existing list of variables/comments, which will not be edited.
- d. White Line: used to display the list of variables/comments obtained from the clipboard, which will not be edited.
- e. OK: applies the lines of the selected check box. The existing list of variables/comments will be deleted to add a new list of variables/comments.
- f. Cancel: The existing list of variables/comments will not be deleted, and a new the list of variables/comments will not be applied accordingly.
- g. Select All: used to check all the check boxes in the [Replace] column.
- h. Unselect All: used to cancel all the selected check boxes in the [Replace] column.

\* If the data saved in the clipboard is of the partial column,

[Steps]

- 1. Select the position to paste on.
- 2. Select [Edit] – [Paste] on the menu.
- 3. If the variable and direct variable are identical on the list of variables/comments, the dialog box will be called.

[Dialog Box]

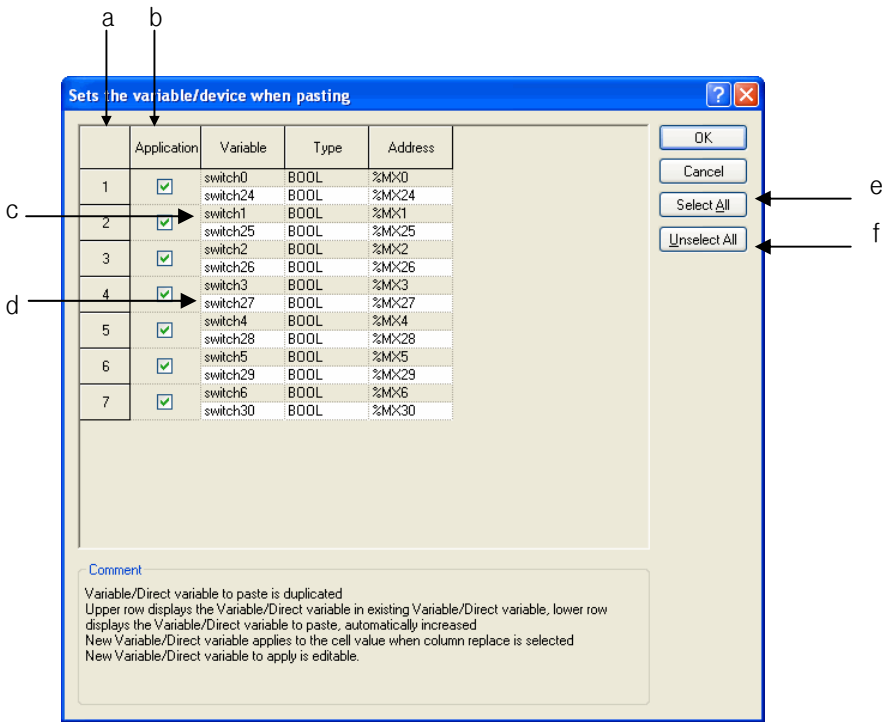

[Comment of Dialog Box]

- a. Number: used to display the duplicated number of the variables and direct variables to paste.
- b. Replace: used to apply Paste.
- c. Gray Line: used to display the data in the existing cell, which will not be edited.
- d. White Line: If the variable or device of the data to paste is duplicated, it will be automatically increased and then displayed on the screen. In addition, the cell can be edited.
- e. Select All: used to check all the check boxes in the [Replace] column.
- f. Unselect All: used to cancel all the selected check boxes in the [Replace] column.

### Notes

- If all items are identical, the cell can not be edited, while if partially identical, the cell can be edited
- If the number of the columns saved in the clipboard is greater than the number of the columns to paste, it is not possible to paste.
- If the data saved in the clipboard is greater than the number of the lines to paste, it is not possible to paste.

### 4.9.3 Insert line

It is used to insert new lines as many as the lines of the selected area, which will make the existing lines move downward.

[Steps]

1. Select the area to insert the lines into.
2. Select [Edit] - [Insert Line] on the menu.

	Variable Name	Type	Memory Address	Initial Value	Retain	Comment
1	Variable1	BOOL			<input type="checkbox"/>	Contact
2	Variable2	BOOL			<input type="checkbox"/>	Contact
3	Variable3	BOOL			<input type="checkbox"/>	Contact
4	Variable4	BOOL			<input type="checkbox"/>	Contact
5	Variable5	BOOL			<input type="checkbox"/>	Contact
6	Variable6	BOOL			<input type="checkbox"/>	Contact
7	Variable7	BOOL			<input type="checkbox"/>	Contact
8	Variable8	BOOL			<input type="checkbox"/>	Contact
9	Variable9	BOOL			<input type="checkbox"/>	Contact
10					<input type="checkbox"/>	
11					<input type="checkbox"/>	
12					<input type="checkbox"/>	
13					<input type="checkbox"/>	

	Variable Name	Type	Memory Address	Initial Value	Retain	Comment
1	Variable1	BOOL			<input type="checkbox"/>	Contact
2	Variable2	BOOL			<input type="checkbox"/>	Contact
3					<input type="checkbox"/>	
4					<input type="checkbox"/>	
5	Variable3	BOOL			<input type="checkbox"/>	Contact
6	Variable4	BOOL			<input type="checkbox"/>	Contact
7	Variable5	BOOL			<input type="checkbox"/>	Contact
8	Variable6	BOOL			<input type="checkbox"/>	Contact
9	Variable7	BOOL			<input type="checkbox"/>	Contact
10	Variable8	BOOL			<input type="checkbox"/>	Contact
11	Variable9	BOOL			<input type="checkbox"/>	Contact
12					<input type="checkbox"/>	
13					<input type="checkbox"/>	
14					<input type="checkbox"/>	
15					<input type="checkbox"/>	

Notes

- If no cell is selected, one line will be added to the first line.
- If Enter key or Tab key is selected at the last of the lines, a new line will be created.



## Chapter 4 Variable

### 4.9.4 Delete line

It is used to delete the lines as many as the lines of the selected area.

[Steps]

1. Select the area to delete the lines from.
2. Select [Edit] - [Delete Line] on the menu.

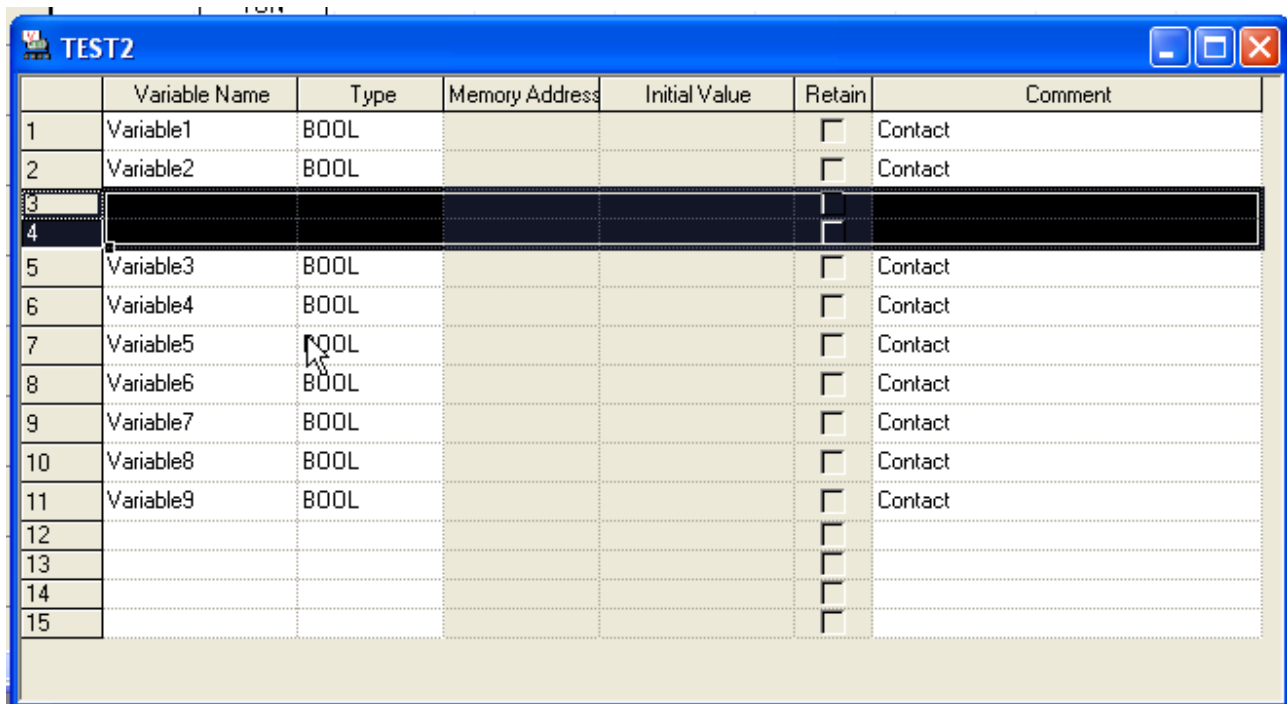

The screenshot shows a window titled "TEST2" with a table containing 15 rows. The columns are Variable Name, Type, Memory Address, Initial Value, Retain, and Comment. Rows 3 and 4 are highlighted in black, indicating they are selected.

	Variable Name	Type	Memory Address	Initial Value	Retain	Comment
1	Variable1	BOOL			<input type="checkbox"/>	Contact
2	Variable2	BOOL			<input type="checkbox"/>	Contact
3					<input type="checkbox"/>	
4					<input type="checkbox"/>	
5	Variable3	BOOL			<input type="checkbox"/>	Contact
6	Variable4	BOOL			<input type="checkbox"/>	Contact
7	Variable5	BOOL			<input type="checkbox"/>	Contact
8	Variable6	BOOL			<input type="checkbox"/>	Contact
9	Variable7	BOOL			<input type="checkbox"/>	Contact
10	Variable8	BOOL			<input type="checkbox"/>	Contact
11	Variable9	BOOL			<input type="checkbox"/>	Contact
12					<input type="checkbox"/>	
13					<input type="checkbox"/>	
14					<input type="checkbox"/>	
15					<input type="checkbox"/>	

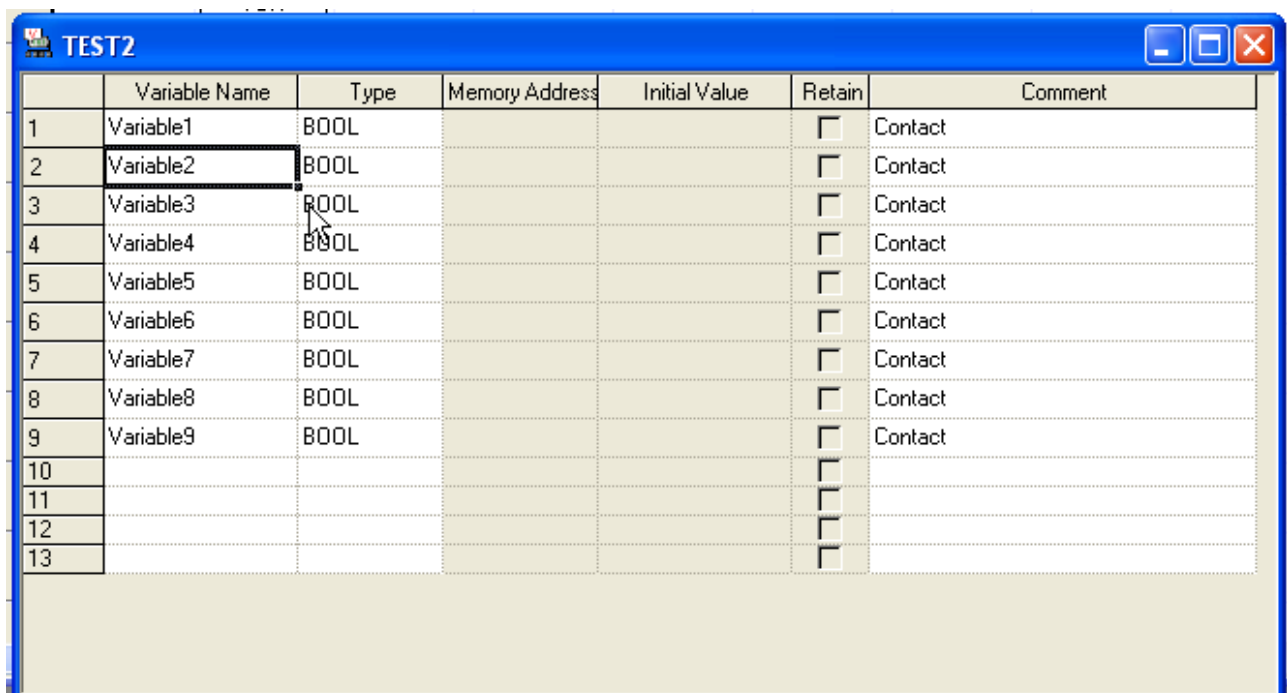

The screenshot shows the same "TEST2" window. In this view, only row 2 is selected, and rows 3 and 4 are no longer highlighted.

	Variable Name	Type	Memory Address	Initial Value	Retain	Comment
1	Variable1	BOOL			<input type="checkbox"/>	Contact
2	Variable2	BOOL			<input type="checkbox"/>	Contact
3	Variable3	BOOL			<input type="checkbox"/>	Contact
4	Variable4	BOOL			<input type="checkbox"/>	Contact
5	Variable5	BOOL			<input type="checkbox"/>	Contact
6	Variable6	BOOL			<input type="checkbox"/>	Contact
7	Variable7	BOOL			<input type="checkbox"/>	Contact
8	Variable8	BOOL			<input type="checkbox"/>	Contact
9	Variable9	BOOL			<input type="checkbox"/>	Contact
10					<input type="checkbox"/>	
11					<input type="checkbox"/>	
12					<input type="checkbox"/>	
13					<input type="checkbox"/>	

Notes

- If no cell is selected, [Delete Line] will not be executed.

4.9.5 Automatic fill

It is used to increase or decrease variables and direct variables to add on the list of variables/comments.

[Steps]

- 1. Move the mouse to the end of the cell and the mouse cursor will change to + shape.
- 2. Move the mouse upward and downward with its left button being pressed.

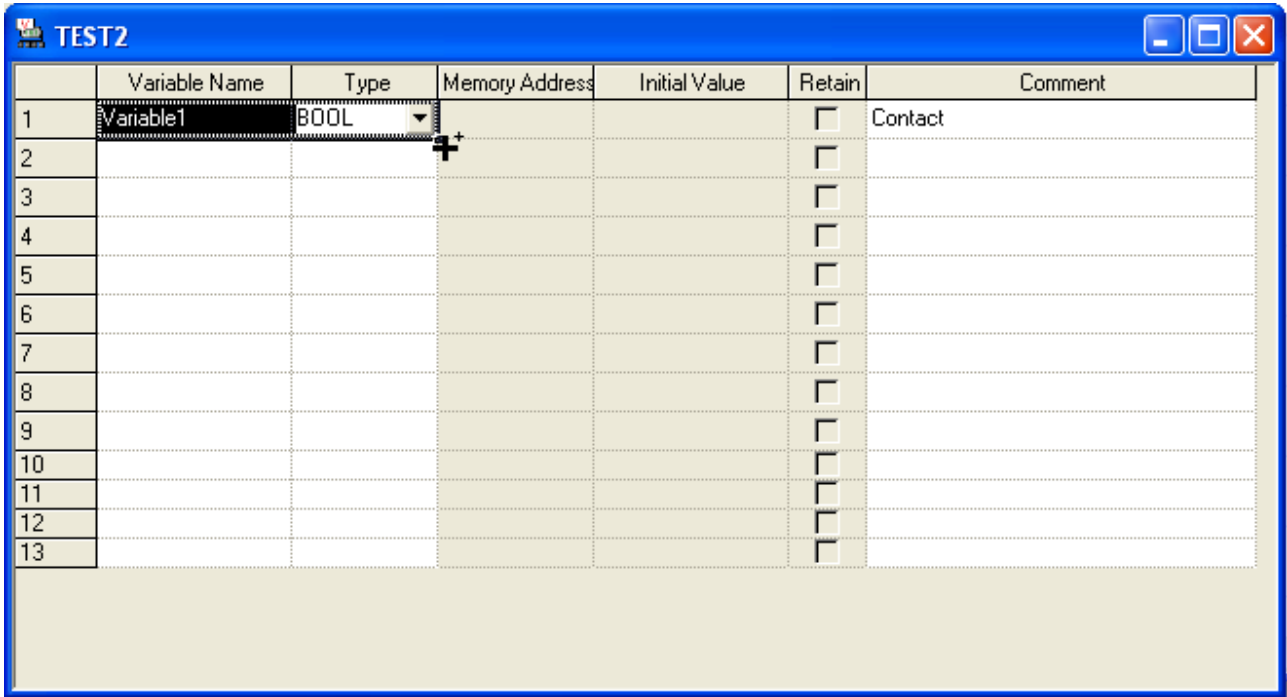

## Chapter 4 Variable

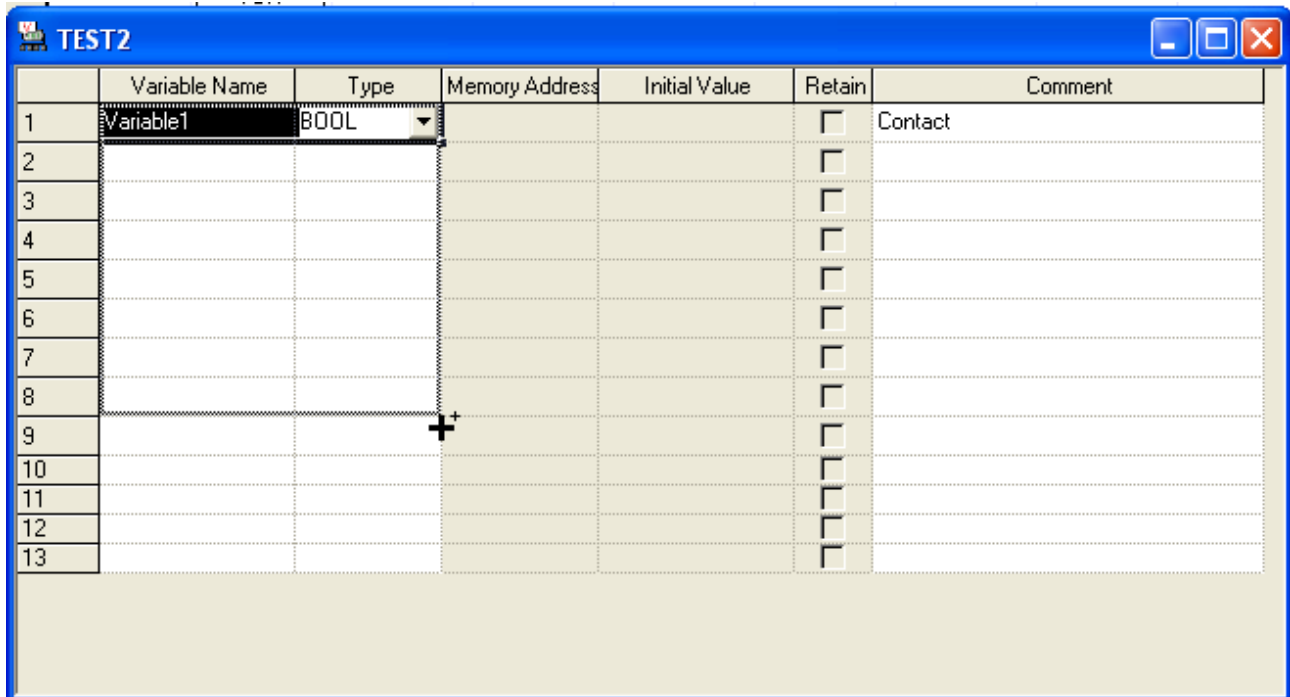

The screenshot shows a software window titled "TEST2" with a table for variable declarations. The table has seven columns: an index column (1-13), Variable Name, Type, Memory Address, Initial Value, Retain, and Comment. Only the first row is populated with "Variable1", type "BOOL", and comment "Contact". The "Retain" checkbox is unchecked. A mouse cursor is positioned over the "Type" dropdown menu.

	Variable Name	Type	Memory Address	Initial Value	Retain	Comment
1	Variable1	BOOL			<input type="checkbox"/>	Contact
2					<input type="checkbox"/>	
3					<input type="checkbox"/>	
4					<input type="checkbox"/>	
5					<input type="checkbox"/>	
6					<input type="checkbox"/>	
7					<input type="checkbox"/>	
8					<input type="checkbox"/>	
9					<input type="checkbox"/>	
10					<input type="checkbox"/>	
11					<input type="checkbox"/>	
12					<input type="checkbox"/>	
13					<input type="checkbox"/>	

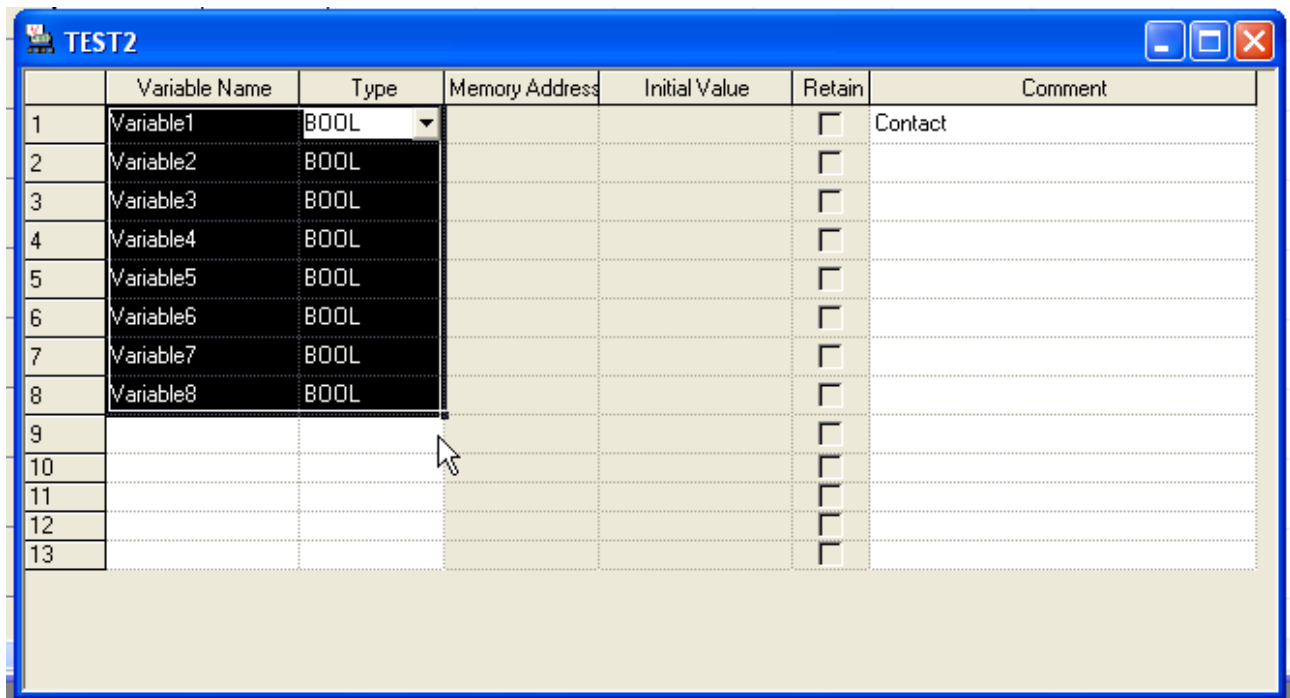

The screenshot shows the same "TEST2" software window, but now the table contains eight entries. The "Variable Name" column is filled with "Variable1" through "Variable8", and the "Type" column is filled with "BOOL" for each. The "Retain" checkboxes are all unchecked. A mouse cursor is positioned over the "Type" dropdown menu for the eighth row.

	Variable Name	Type	Memory Address	Initial Value	Retain	Comment
1	Variable1	BOOL			<input type="checkbox"/>	Contact
2	Variable2	BOOL			<input type="checkbox"/>	
3	Variable3	BOOL			<input type="checkbox"/>	
4	Variable4	BOOL			<input type="checkbox"/>	
5	Variable5	BOOL			<input type="checkbox"/>	
6	Variable6	BOOL			<input type="checkbox"/>	
7	Variable7	BOOL			<input type="checkbox"/>	
8	Variable8	BOOL			<input type="checkbox"/>	
9					<input type="checkbox"/>	
10					<input type="checkbox"/>	
11					<input type="checkbox"/>	
12					<input type="checkbox"/>	
13					<input type="checkbox"/>	

### [Details]

- a. Variable Name: it always executes Automatic Fill because a variable can not be declared in duplicate. If it contains a number, it automatically increases. If not, it adds a number at the end and counts it automatically
- b. Type: it is filled in a cell as copied.
- c. Memory address: Read Only; it can not be modified.
- d. Initial value: Read Only; it can not be modified.
- e. Retain: Read Only; it can not be modified.
- f. Comment: If Automatic Fill is executed with Ctrl key being pressed, the figures area will automatically increase, and if with Ctrl key not pressed, it will be copied.

### Notes

- If Automatic Fill is executed with an empty cell, it will be deleted.
- Automatic Fill is available for many cells.

### 4.9.6 Drag & Drop

It is used to copy the selected items to paste on different positions.

### [Steps]

1. Select the area to drag and drop.
2. The mouse cursor will change to the state available for drag and drop.
3. With the left mouse button being pressed, drag and drop the selected items onto a position to paste on.

# Chapter 4 Variable

	Variable Name	Type	Memory Address	Initial Value	Retain	Comment
1	Contact1	BOOL			<input type="checkbox"/>	Contact
2	Contact2	BOOL			<input type="checkbox"/>	Contact
3	Contact3	BOOL			<input type="checkbox"/>	Contact
4					<input type="checkbox"/>	
5					<input type="checkbox"/>	
6					<input type="checkbox"/>	

	Variable Name	Type	Memory Address	Initial Value	Retain	Comment
1	Contact1	BOOL			<input type="checkbox"/>	Contact
2	Contact2	BOOL			<input type="checkbox"/>	Contact
3	Contact3	BOOL			<input type="checkbox"/>	Contact
4					<input type="checkbox"/>	
5					<input type="checkbox"/>	
6					<input type="checkbox"/>	

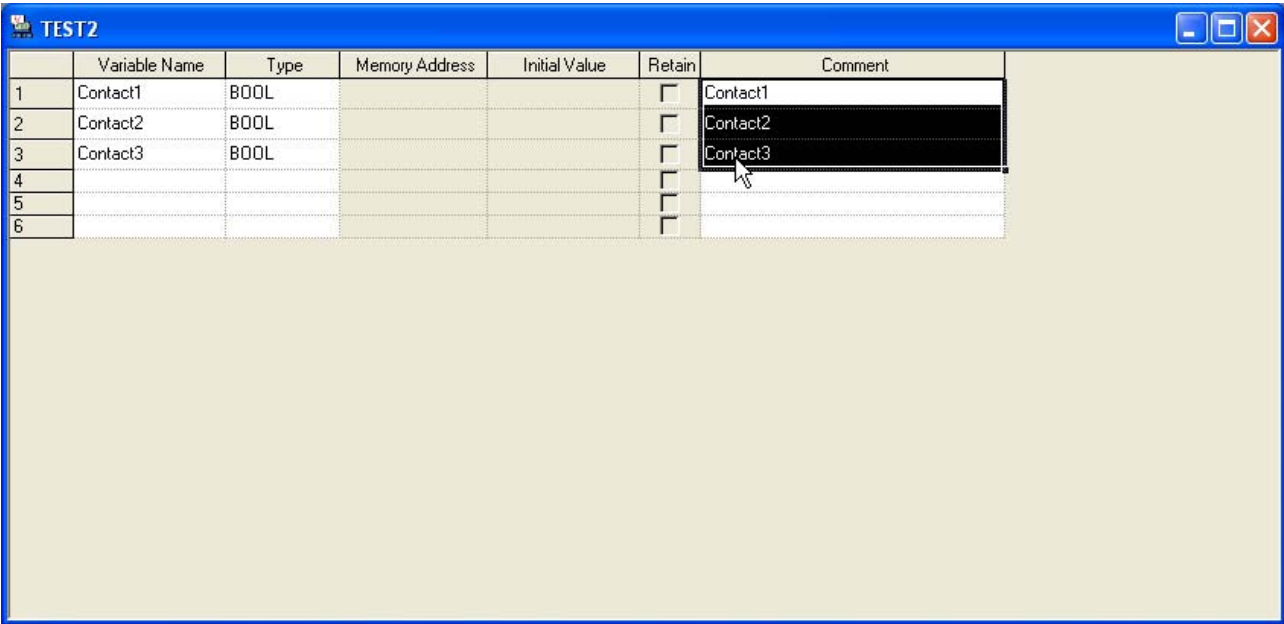

[Details]

- a. Copy is available when drag and drop is executed onto Excel program.
- b. Drag and drop is available onto Global Variable of other XG5000 programs.

**Notes**  
Data is not moved but just copied always when dragged and dropped.

### 4.9.7 Undo/Redo

Undo is used to cancel the edited detail in order to return to its previous state. Redo cancels again the operation of Edit Cancel.

[Details]

- 1. Undo/Redo is available for Cell Edit.
- 2. Undo/Redo is available for Change.
- 3. Undo/Redo is available for All Change.
- 4. Undo/Redo is available for Delete.
- 5. Undo/Redo is available for Cut.
- 6. Undo/Redo is available for Paste.
- 7. Undo/Redo is available for Automatic Fill.
- 8. Undo/Redo is available for Insert Line. (Only in Global Variable)

## Chapter 4 Variable

9. Undo/Redo is available for Delete Line. (Only in Global Variable)
10. Undo/Redo is available for drag and drop.
11. Undo/Redo is available for Align.
12. Undo/Redo is executed above the item.
13. Undo/Redo is executed below the item.

### 4.9.8 Export to file

It is used to save the previously declared list of global variables on the file and to open and read in the external programs.

[Steps]

1. Select [Edit] - [Export to File] on the menu

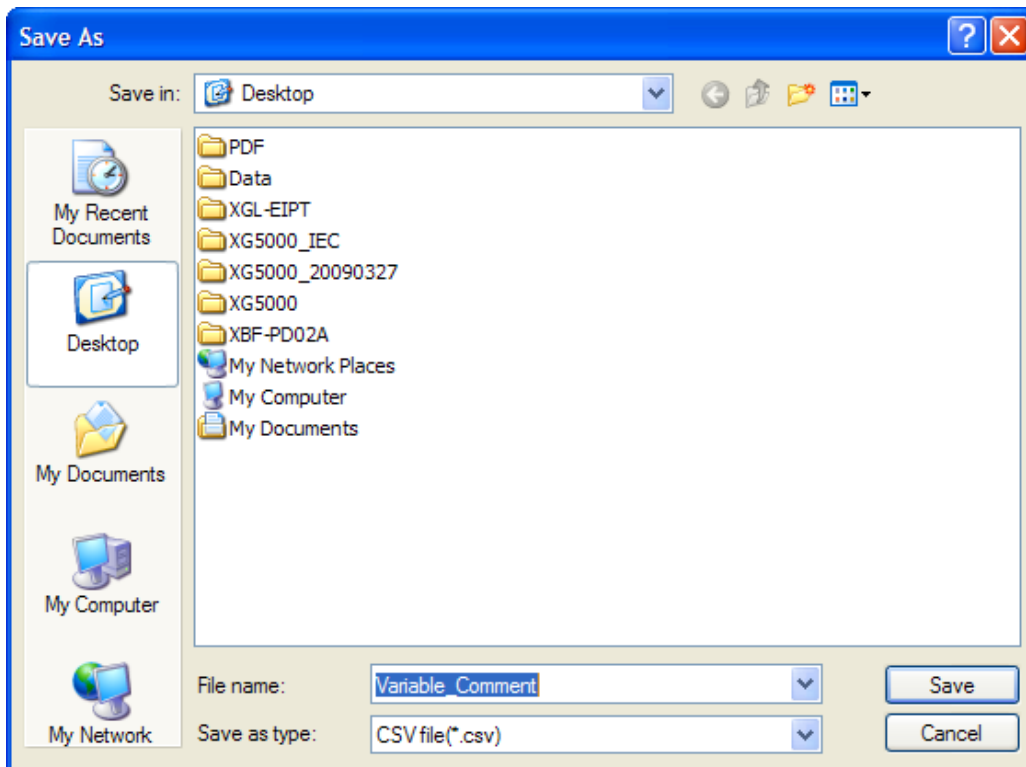

If you press 'Save', file is saved as inputted file name at selected folder location.

If you press 'Cancel', file is not created and dialog box is closed

File is classified by tap.

## 4.10 Sharing Variable

XG5000 is programming tool for PLC. In PLC program, factor and step consist of variable and device. Variable and device need to be observed by external device. To be observed by external program, saves variable and device as CSV file.

Flag and Variable/Comments can be saved

### 4.10.1 Saving variable/comment

[Steps]

1. Select item to be saved in project window.

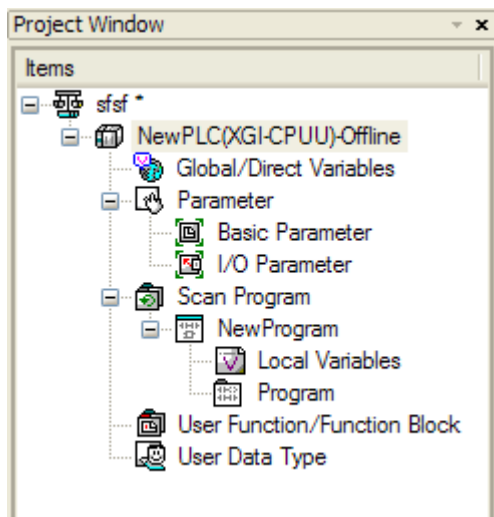



## Chapter 4 Variable

### 2. Select [Project]-[Save Variable Names to File]

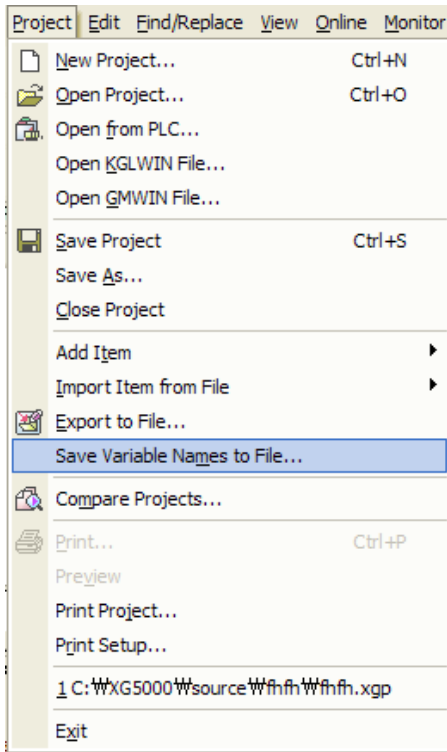

[Dialog box]

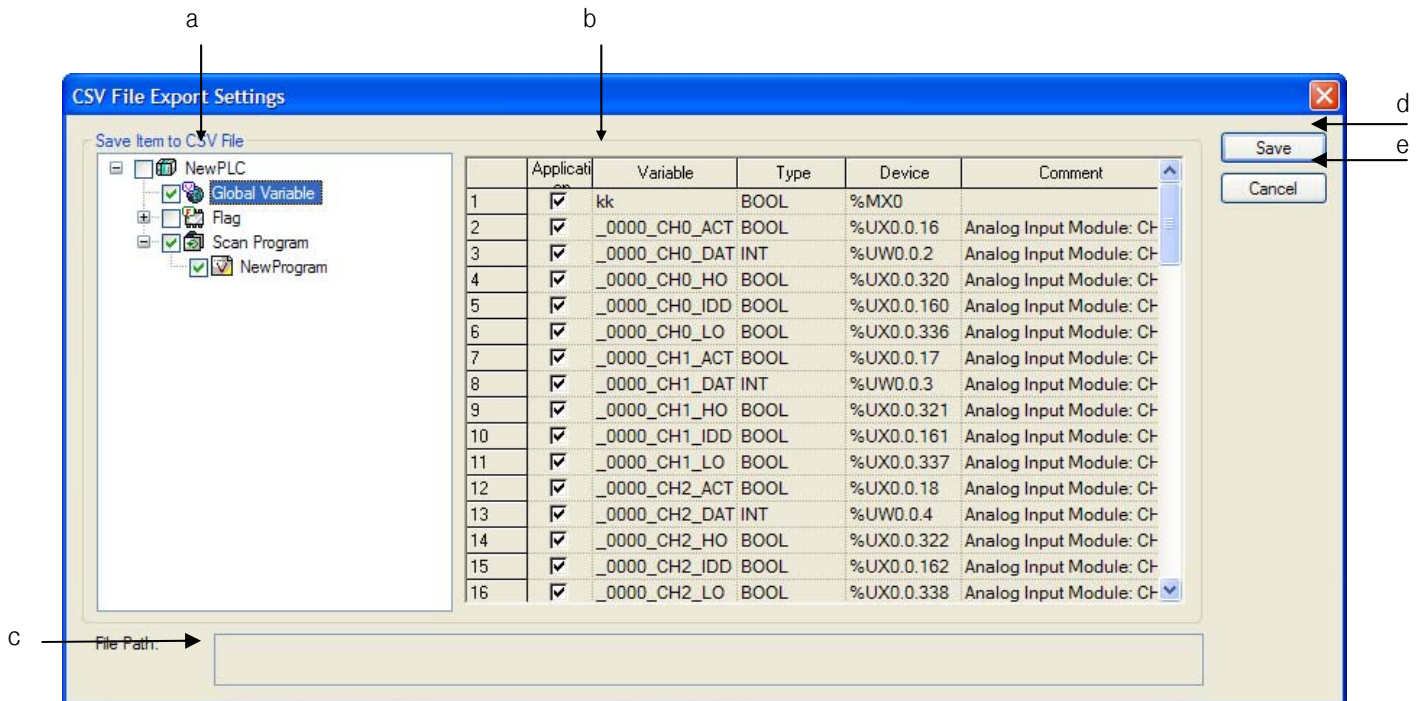

[Description of dialog box]

- a. Item for saving: select item to be saved.
  - If you check upper box, all lower boxes are checked.
  - If you click on +, - button, tree is enlarged or reduced.
  - If you click one item, variables of selected item shows art right grid.
- b. Application: only selected variable is saved.
- c. File Path: specifies file path where CSV file is saved
- d. Save: if you click on this button, the following dialog box shows. Set the file path and file name.

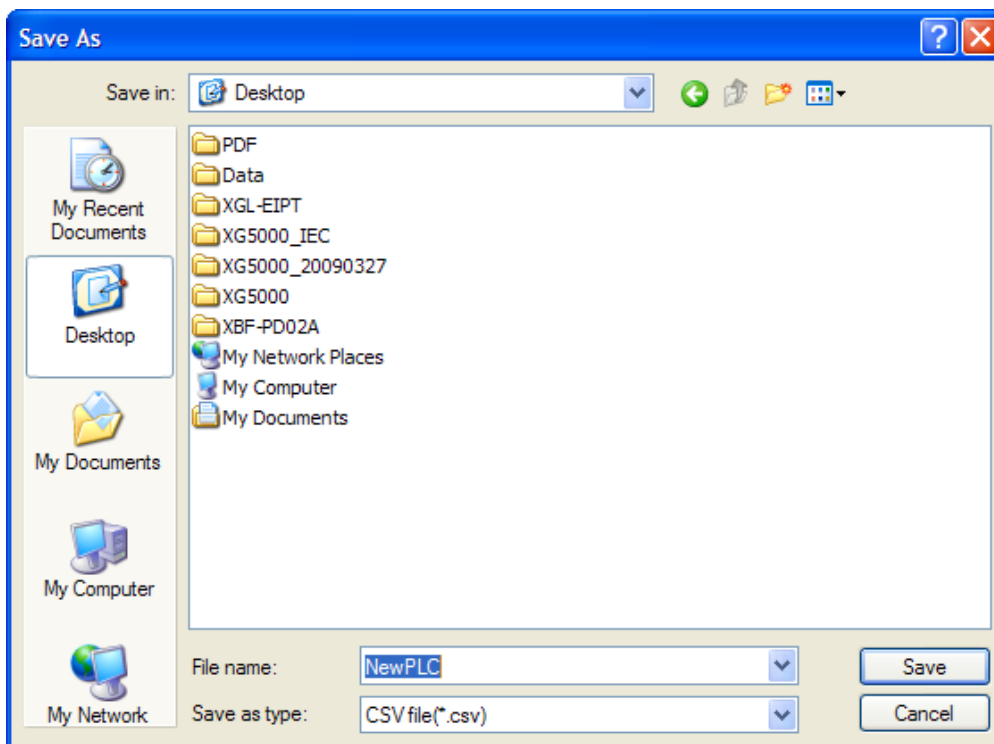

- Default file name is PLC name and you can change it.
  - If you press 'SAVE', CSV file is created and saved.
  - If you press 'Cancel', CSV file is not created and the window is closed
- e. Cancel: CSV file is not created and the window is closed.

## Chapter 4 Variable

### 4.10.2 CSV file structure

Remark	Title= CSV File					
Remark	Date=2008-04-15					
Remark	Version=Ver3.0					
Remark	PLC Name=NewPLC					
Remark	CPU Type=XGI-CPUH					
Type	Scope	Variable	Address	DataType	Property	Comment
Tag	GlobalVariable	adfasdf	%MD0	DINT		SDFSD
Tag	GlobalVariable	dasdfa	%MD1	DINT		DDD
Tag	GlobalVariable	dddsd sdf	%AX0	BOOL	A	AAA
Tag	GlobalVariable	sdfsdf	%AX1	BOOL	A	
Tag	GlobalVariable	sfasdf	%AX2	BOOL	A	
Tag	GlobalVariable	adfasdf	%AX3	BOOL		
Type	Scope	Variable	Address	DataType	Property	Comment
Tag	Flag\System	_1OFF	%FX156	BOOL	R	1 scan OFF
Tag	Flag\System	_1ON	%FX155	BOOL	R	1 scan ON
Tag	Flag\System	_AB_SD_ER	%FX67	BOOL	R	EMG stop
Type	Scope	Variable	Address	DataType	Property	Comment
Tag	ScanProgram\NewProg	%AW1	WORD	DINT	A	Comment 1
Tag	ScanProgram\NewProg	%AX5	BOOL	DINT	A	Comment 2
Type	Scope	Variable	Address	DataType	Property	Comment
Tag	ScanProgram\NewProg1	%AW2	WORD	DINT	A	SDFS
Tag	ScanProgram\NewProg1	%AB1	USINT	DINT	A	

[Description of file structure]

1. Remark: shows information (shows data for reference)

Title: displays file format

Date: displays file-created date

Version: displays file version

PLC Name: displays Configuration name

CPU Type: displays CPU type

2. Type: displays data type

Scope: displays scope which tag is belonged to

Variable: displays variable name

Address: displays device of variable (displayed in XGK, XGI format)

Data Type: displays data type (displayed in XGK, XGI format)

Property: displays whether this variable is Auto-variable(A) read-only variable(R)

Comment: displays comment of variable

3. Tag: displays content of variable

### Note

- In case ' ' ' is used in comment, it changes into ' \$Q ' in CSV file
- In case ' \$ ' is used in comment, it changes into " \$\$ " in CSV file

### 4.10.3 Import external variable in XG-PD

In order to refer to the variable and device of PLC program in XG-PD, specifies as shown below

[Steps]

1. Saves CSV file at XG5000 to be used in XG-PD. CPU type of XG5000 and XG-PD should be same.

## Chapter 4 Variable

2. Select area to use external variable in High-speed Link Block and click on right button of mouse. Select [Import variable name] in the created context menu

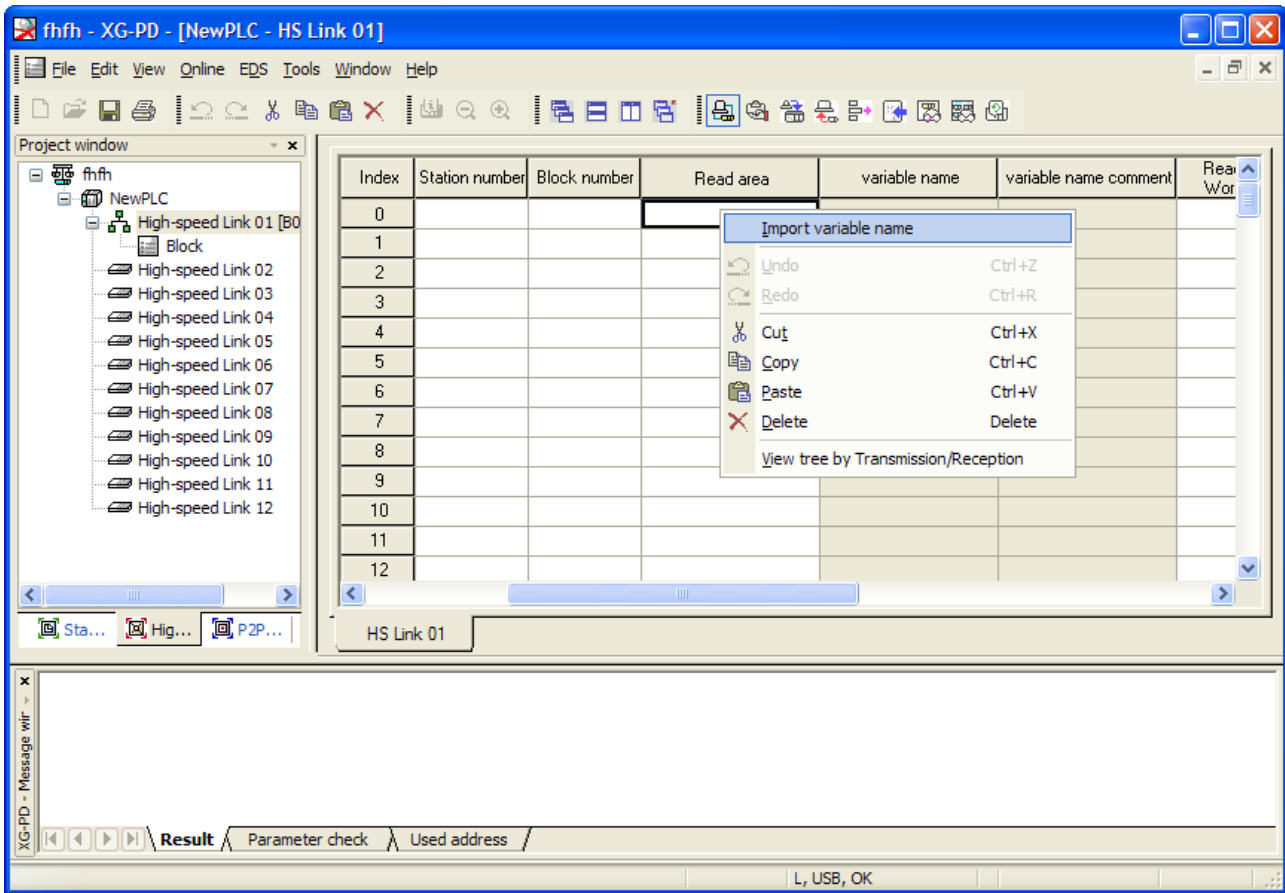

3. Click "File Open" and select file created by step 1. Then click on 'Open'.

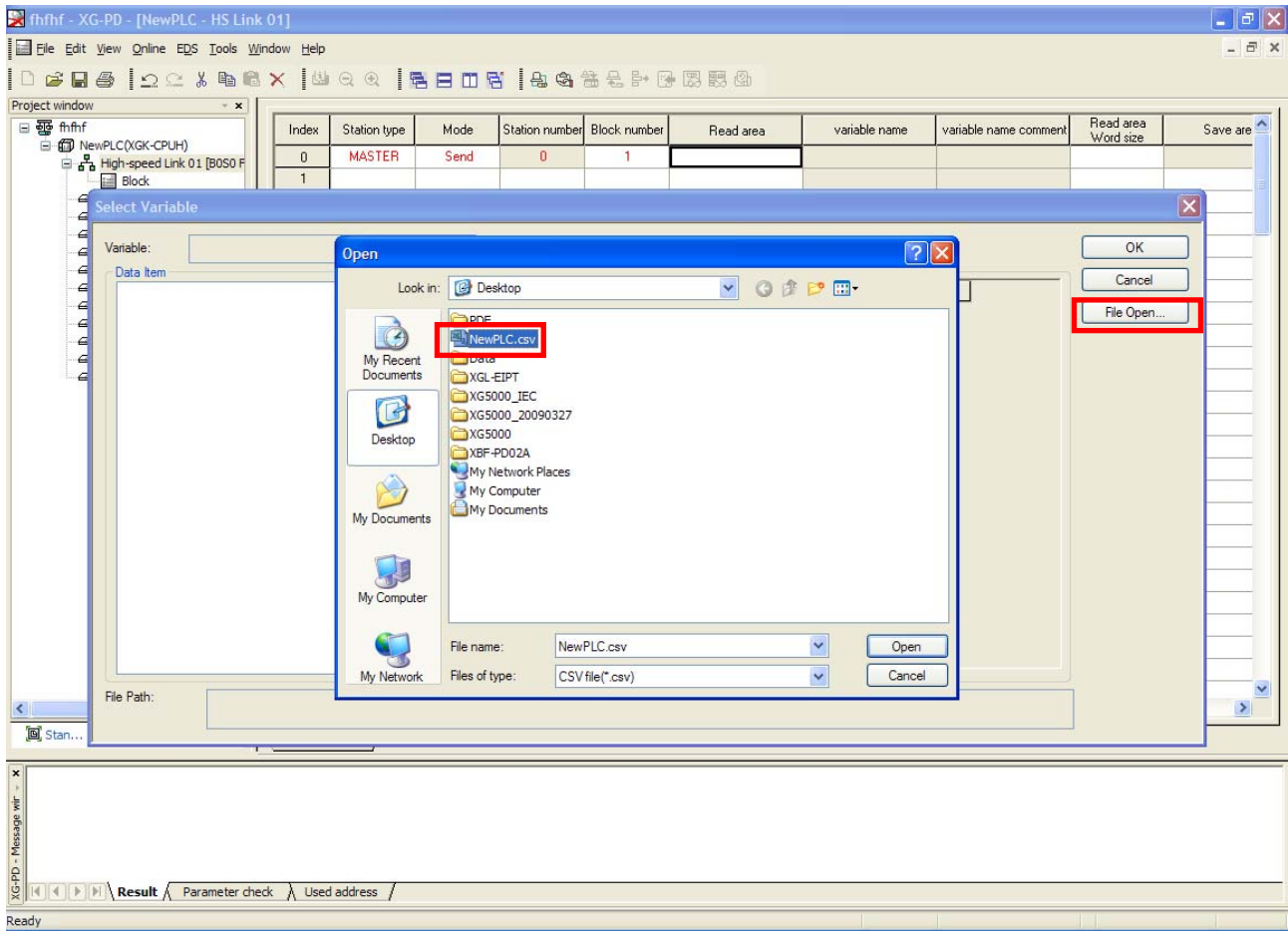

4. If you select item in data item, the variable list shows. Select variable in variable list and click 'OK'

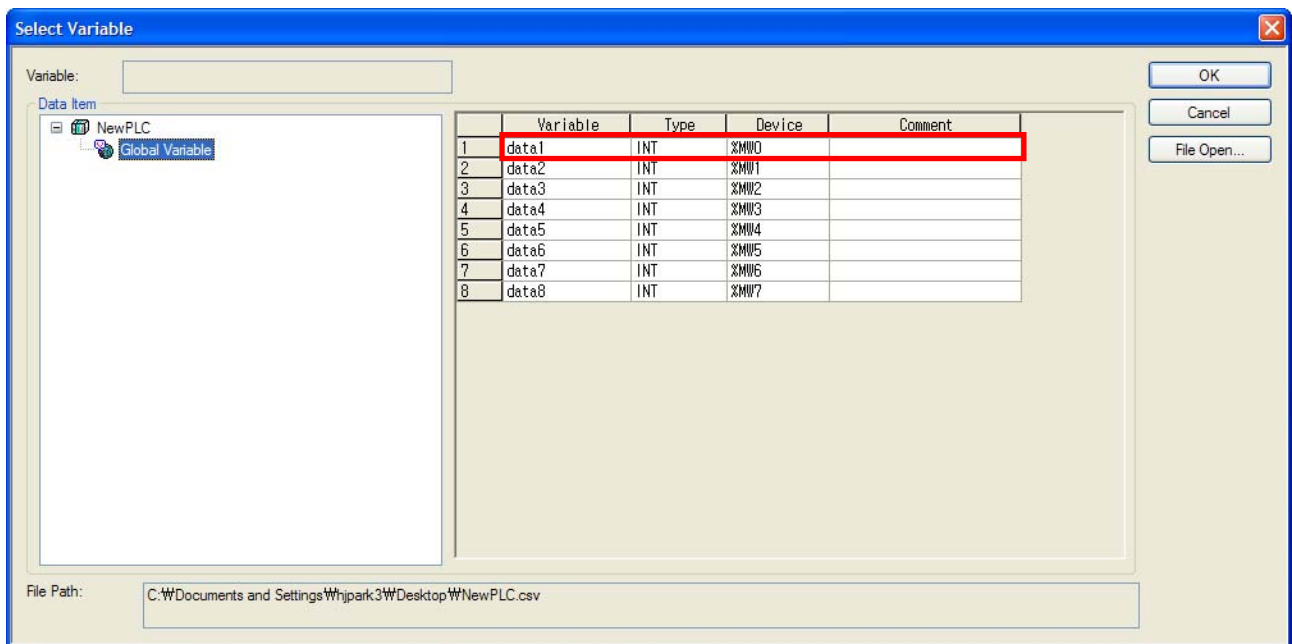

## Chapter 4 Variable

5. In High-Speed Link window, Read area, variable, variable comment is shown as below

The screenshot shows the 'sfsf - XG-PD - [NewPLC - HS Link 01]' window. The 'Project window' on the left shows a tree view with 'NewPLC(XGI-CPU)' and 'High-speed Link 01 [BOS0 F]'. The main window displays a table with the following data:

Index	Mode	Station number	Block number	Read area	variable name	variable name
0				%MWO	data1	
1						
2						
3						
4						
5						
6						
7						
8						
9						
10						
11						
12						

The 'Read area' and 'variable name' columns for Index 0 are highlighted with a red box. The status bar at the bottom shows 'Ready' and navigation buttons for 'Result', 'Parameter check', and 'Used address'.

## Chapter 5 LD Edit

LD program displays the PLC program through graphic signals of coils or contact points used in the relay logic diagram.

### 5.1 Limit

There are functional limits in LD Program Edit as described below.

Item	Description	Limit
Maximum contact points	Maximum contact points available to input in a line	Up to 31
Maximum lines	Maximum lines available to edit	Up to 65535
Maximum Copy lines	Maximum Copy lines available to copy at a time	Up to 300
Maximum Paste lines	Maximum Paste lines to paste at a time	Up to 300

### 5.2 Program Edit

#### 5.2.1 Edit Tools



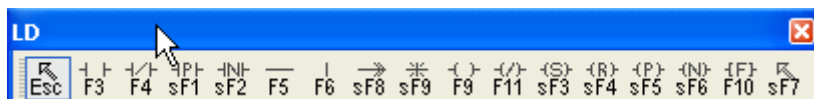





The input of LD Edit items shall be started after the input symbols are selected from the LD tool box and the mouse clicked on the specified position or with applicable Shortcut Key pressed.



Symbol	Shortcut key	Description
	Esc	Changes to selection mode
	F3	Normally open contact point
	F4	Normally closed contact point
	Shift + F1	Positive-conversion detection contact point
	Shift + F2	Negative-conversion detection contact point
	F5	Horizontal line
	F6	Vertical line
	Shift + F8	Connection line



## Chapter 5 LD Edit

Symbol	Shortcut key	Description
 sF9	Shift + F9	Reverse input
 F9	F9	Coil
 F11	F11	Reverse coil
 sF3	Shift + F3	Set(latch) coil
 sF4	Shift + F4	Reset(unlatch) coil
 sF5	Shift + F5	Positive-conversion detection coil
 sF6	Shift + F6	Negative-conversion detection coil
 F10	F10	Function/Function block
 sF7	Shift + F7	Extended function

The following Shortcut Keys are related with the movement of the cursor. Applicable Shortcut Keys can not be specified by users XG5000.

Shortcut Key	Description
Home	Moves to the start of the column.
Ctrl+Home	Moves to the start of the program
Back space	Deletes the present data and moves to the left.
→	Moves the present cursor to the right by a blank.
←	Moves the present cursor to the left by a blank.
↑	Moves the present cursor upward by a blank.
↓	Moves the present cursor downward by a blank.
End	Moves to the end of the column.
Ctrl+End	Moves to the last line edited.

### Notes

- Among Shortcut Keys in Edit Toolbox, 's' stands for Shift key, 'c' for Ctrl key.  
*Example*) Positive-conversion detection contact point: Shift + F1 → s + F1 → sF1
- The Shortcut Keys described in Edit Tool are based on the Shortcut Keys basically provided in XG5000.
- For setting details on the user defined Shortcut Keys, Refer to 2.4 Shortcut Setting in Chapter 2 Basic Application.

## 5.2.2 Input Contact point

This is used to input the contact points (normally open contact, normally closed contact, positive-conversion detection contact and negative-conversion detection contact).

[Steps]

1. Move the cursor to the location to input the contact point on.



2. On the tool box, select the type of the contact to input and then click the edit area. Or click the Shortcut Key applicable to the contact to input.
3. After the device name is input on the Variable Input Dialog Box, click [OK]. Refer to 5.2.3 Variable/Device Input for details on the Variable Input Dialog Box.



### Notes

- Select [Tool]-[Option] on the menu. If the Input mode is promptly released from the Edit page, the Variable Input Dialog Box will not be automatically displayed when inserting a contact point and coil.

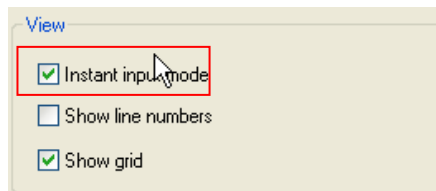

- The basic operation of Enter key is to input identical kind of instruction used previous edit.

*Example*) If a normally open contact is input and entered in the previous edit, the normally open contact input dialog box will be displayed when enter key is pressed.

### 5.2.3 Input OR contact point

Inputs OR contact point (Normally opened OR contact point, Normally closed OR contact point, Positive-conversion detection OR contact point, Negative-conversion detection OR contact point)

[Steps]

1. Move the cursor where you want connect OR

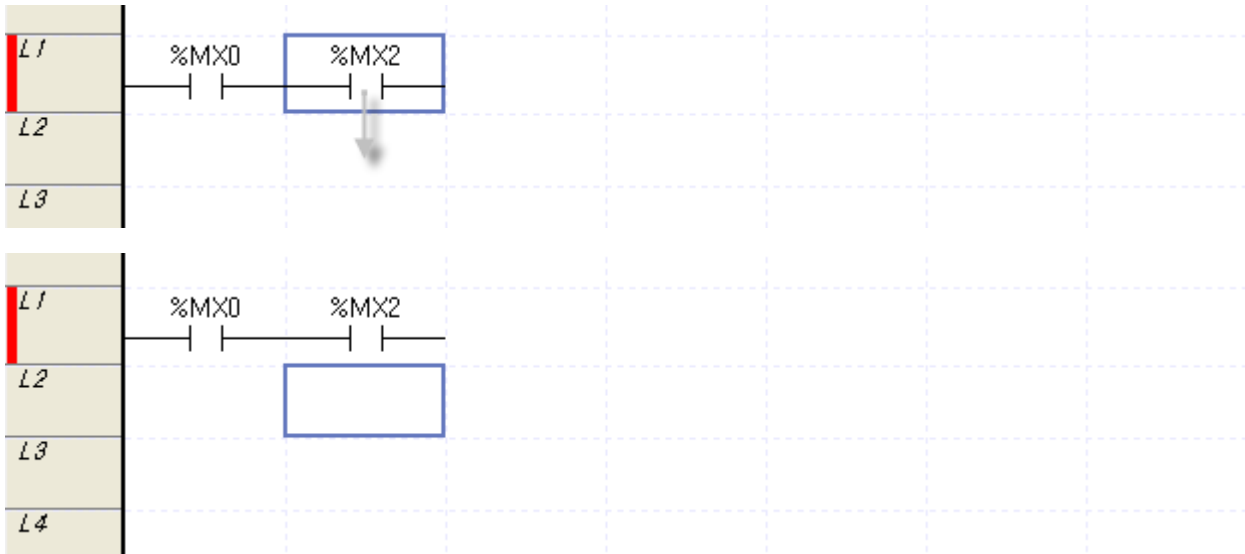

2. Select contact point kind at Toolbar and click editing area. Or press shortcut key corresponding to OR contact point

3. Input device name at dialog box for variable input. For detail on dialog box for variable input, refer to 5.2.4



#### Note

- In duplicated mode, in case contact point is in cursor, OR connection does not operate

### 5.2.4 Input Variable/Device

It is used to input the Device or Variable/Comment.

[Dialog Box]

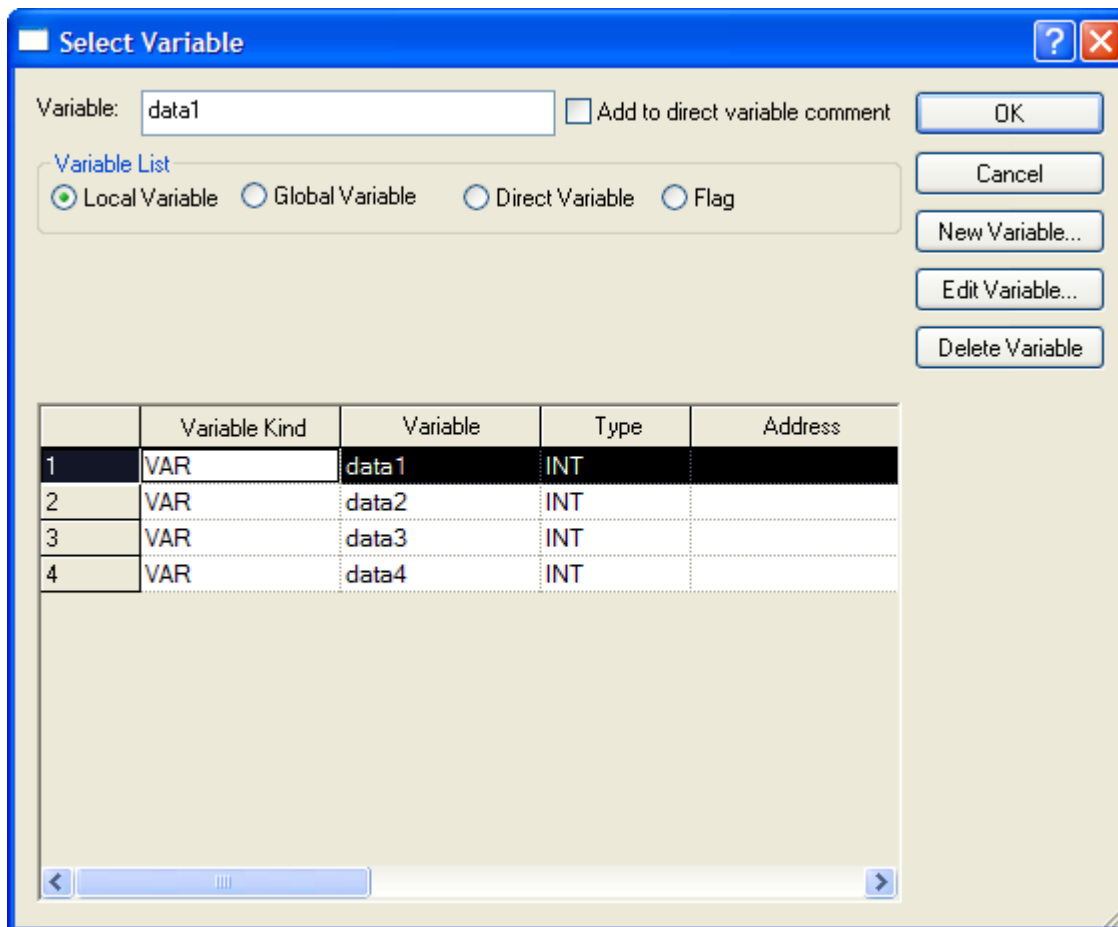

[Description of Dialog Box]

## Chapter 5 LD Edit

- Variable: used to input a variable or declared variable name. If the input String is of variable format and the applicable String is not registered as a variable in the Variable/Comment, the Variable/Comment Add Dialog Box will be displayed.
- Local variable: displays the list of declared local variable
- New Variable: recalls dialog box to add variable into local variable list

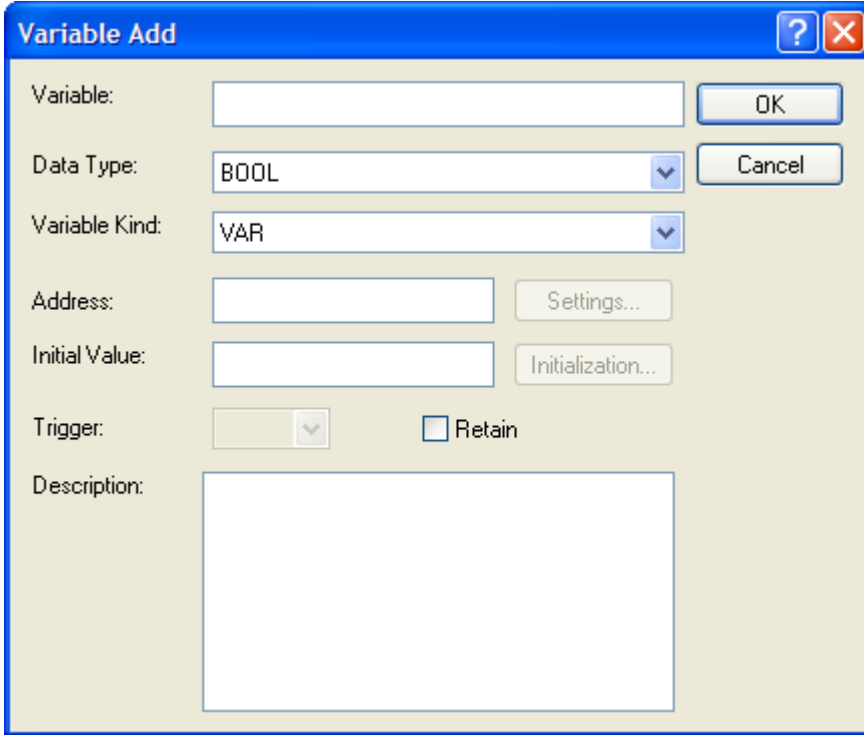

The Variable Add dialog box is a standard Windows-style window with a blue title bar containing a question mark and a close button. The main area has a light beige background. It contains the following fields and controls:

- Variable:** A text input field with an empty space.
- Data Type:** A dropdown menu currently showing "BOOL".
- Variable Kind:** A dropdown menu currently showing "VAR".
- Address:** A text input field with an empty space, followed by a "Settings..." button.
- Initial Value:** A text input field with an empty space, followed by an "Initialization..." button.
- Trigger:** A dropdown menu with a downward arrow, followed by a checkbox labeled "Retain" which is currently unchecked.
- Description:** A large empty text area.
- Buttons:** "OK" and "Cancel" buttons are located on the right side of the dialog.

- Edit Variable: recalls dialog box to edit the selected variable

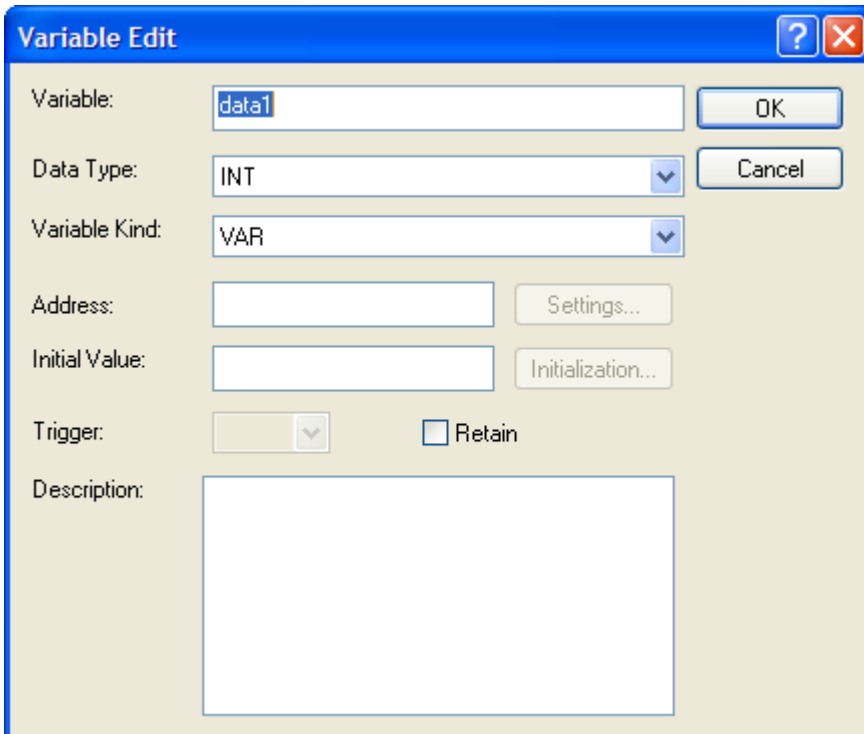

The Variable Edit dialog box is identical in layout to the Variable Add dialog box. It features a blue title bar with a question mark and a close button. The main area has a light beige background. The fields and controls are:

- Variable:** A text input field containing the text "data1".
- Data Type:** A dropdown menu currently showing "INT".
- Variable Kind:** A dropdown menu currently showing "VAR".
- Address:** A text input field with an empty space, followed by a "Settings..." button.
- Initial Value:** A text input field with an empty space, followed by an "Initialization..." button.
- Trigger:** A dropdown menu with a downward arrow, followed by a checkbox labeled "Retain" which is currently unchecked.
- Description:** A large empty text area.
- Buttons:** "OK" and "Cancel" buttons are located on the right side of the dialog.

- e. Delete Variable: deletes the selected variable from local variable list
- f. OK: applies the inputted or selected items and closes the dialog box
- g. Cancel: closes dialog box

[Dialog box]

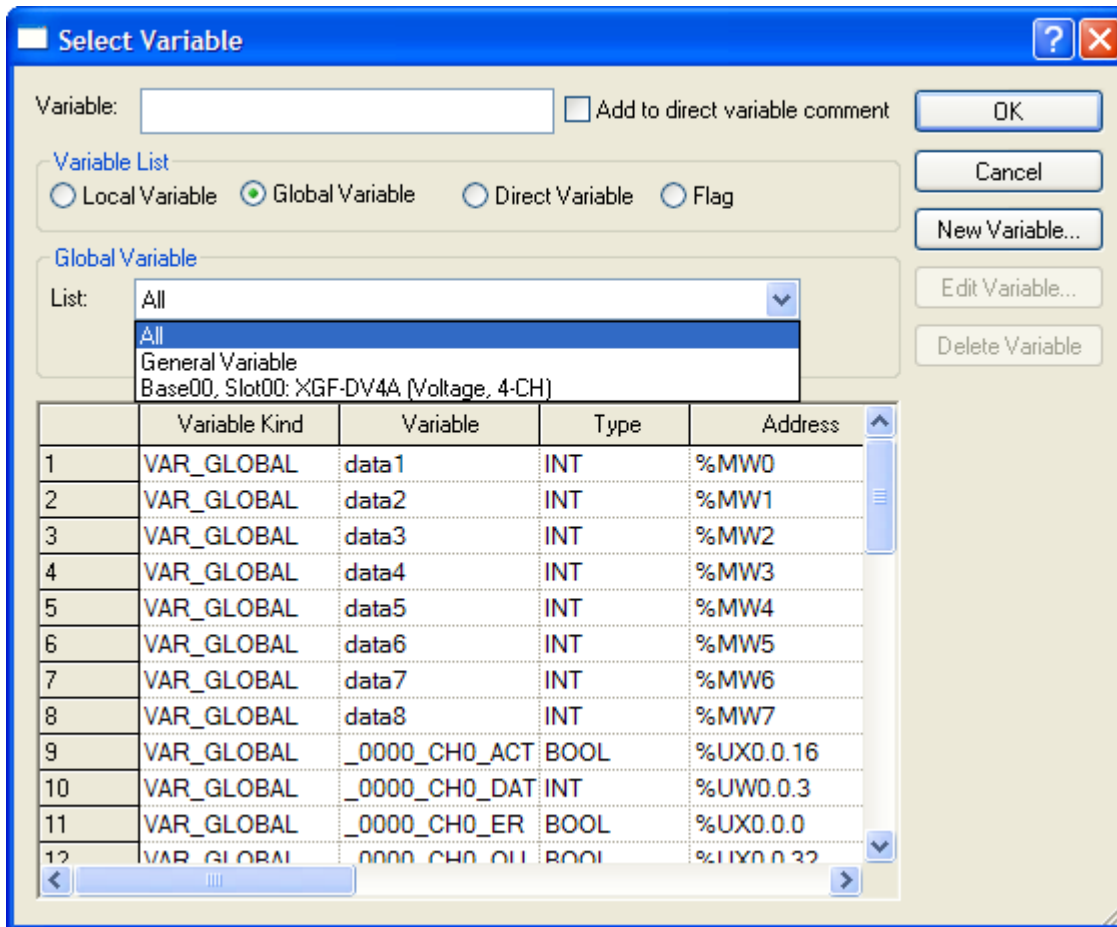

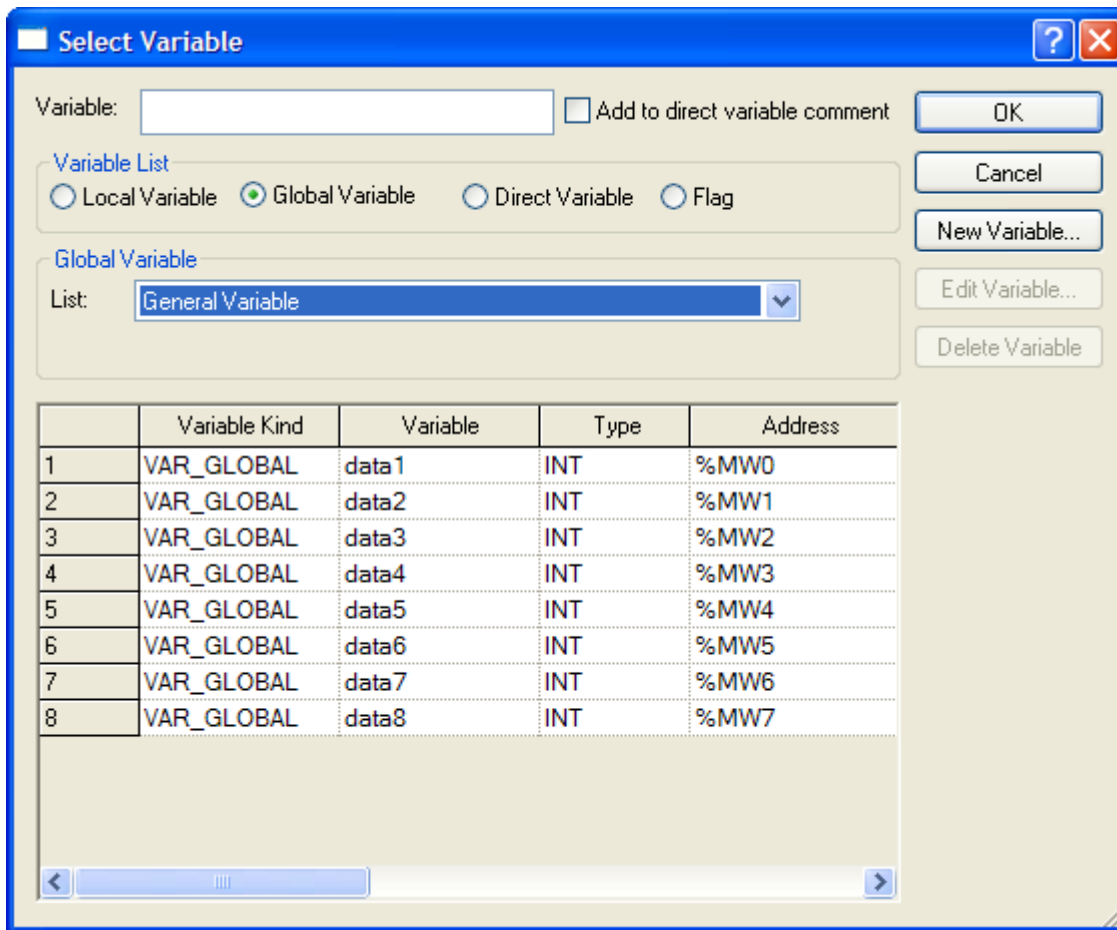

[Description of dialog box]

- Global variable: displays the declared global variable list. Can be registered as EXTERNAL variable
- Global variable list: classify the entire list into all, general variable, special module related variable
- New Variable: recalls the dialog box to add variable into global variable list

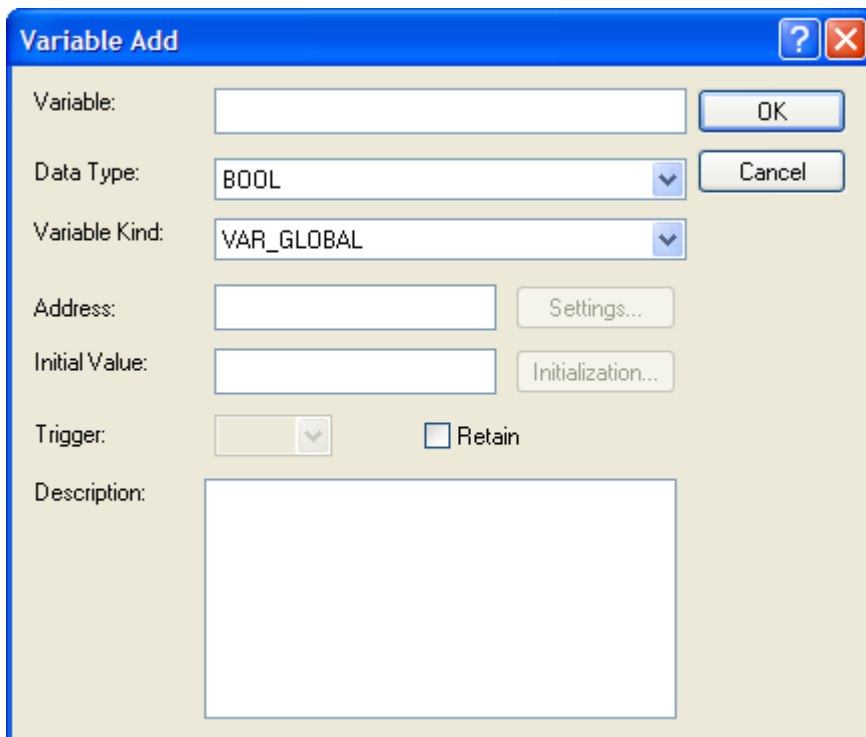

The image shows a 'Variable Add' dialog box with the following fields and controls:

- Variable:** A text input field.
- Data Type:** A dropdown menu currently showing 'BOOL'.
- Variable Kind:** A dropdown menu currently showing 'VAR\_GLOBAL'.
- Address:** A text input field with a 'Settings...' button to its right.
- Initial Value:** A text input field with an 'Initialization...' button to its right.
- Trigger:** A dropdown menu and a checkbox labeled 'Retain'.
- Description:** A large text area.
- Buttons:** 'OK' and 'Cancel' buttons are located on the right side of the dialog.

- d. Edit variable: this item is not provided
- e. Delete variable: this item is not provided
- f. OK: registers the inputted or selected variable as External variable at local variable list and closes the dialog box.
- g. Cancel: closes the dialog box



## Chapter 5 LD Edit

[Dialog box]

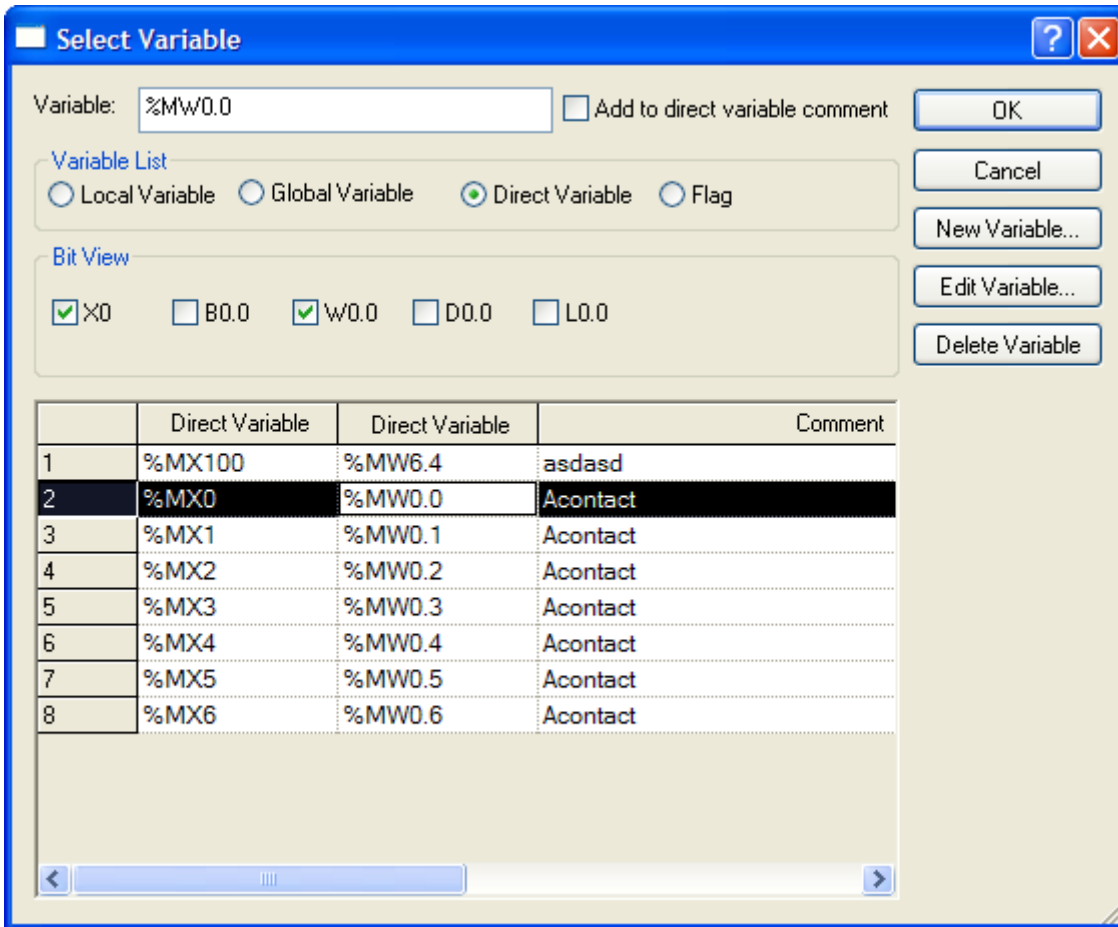

[Description of dialog box]

- Direct variable: displays direct variable list
- Bit View: for bit type direct variable, displays direct variable in diverse type. Displayed in Bit (X0), byte (B0.0), word (W0.0), double word (D0.0), long word (L0.0).
- New Variable: recalls dialog box to add comment of variable at direct variable list

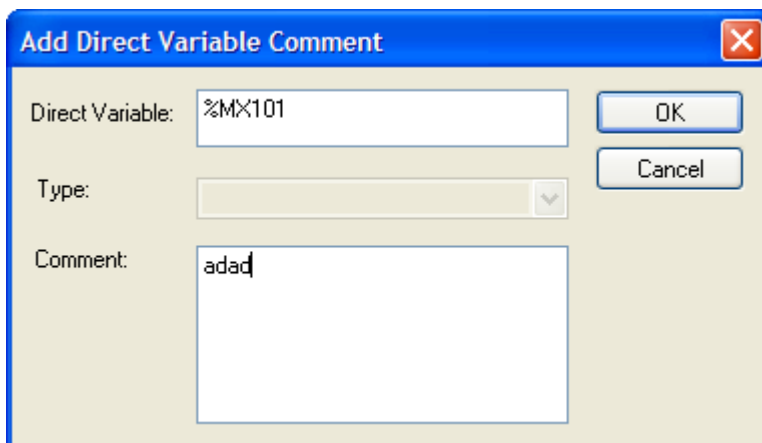

d. Edit variable: recalls the dialog box to edit the direct variable comment

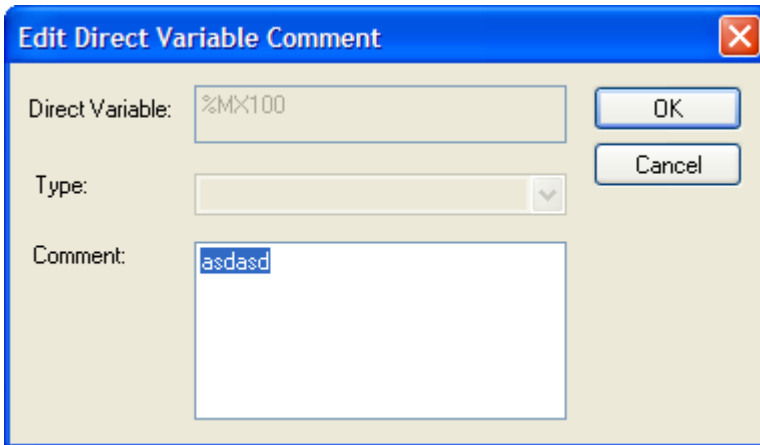

e. Delete Variable: deletes the selected direct variable from direct variable list

f. OK: applies the inputted or selected item and closes the dialog box

g. Cancel: closes the dialog box

[Dialog box]

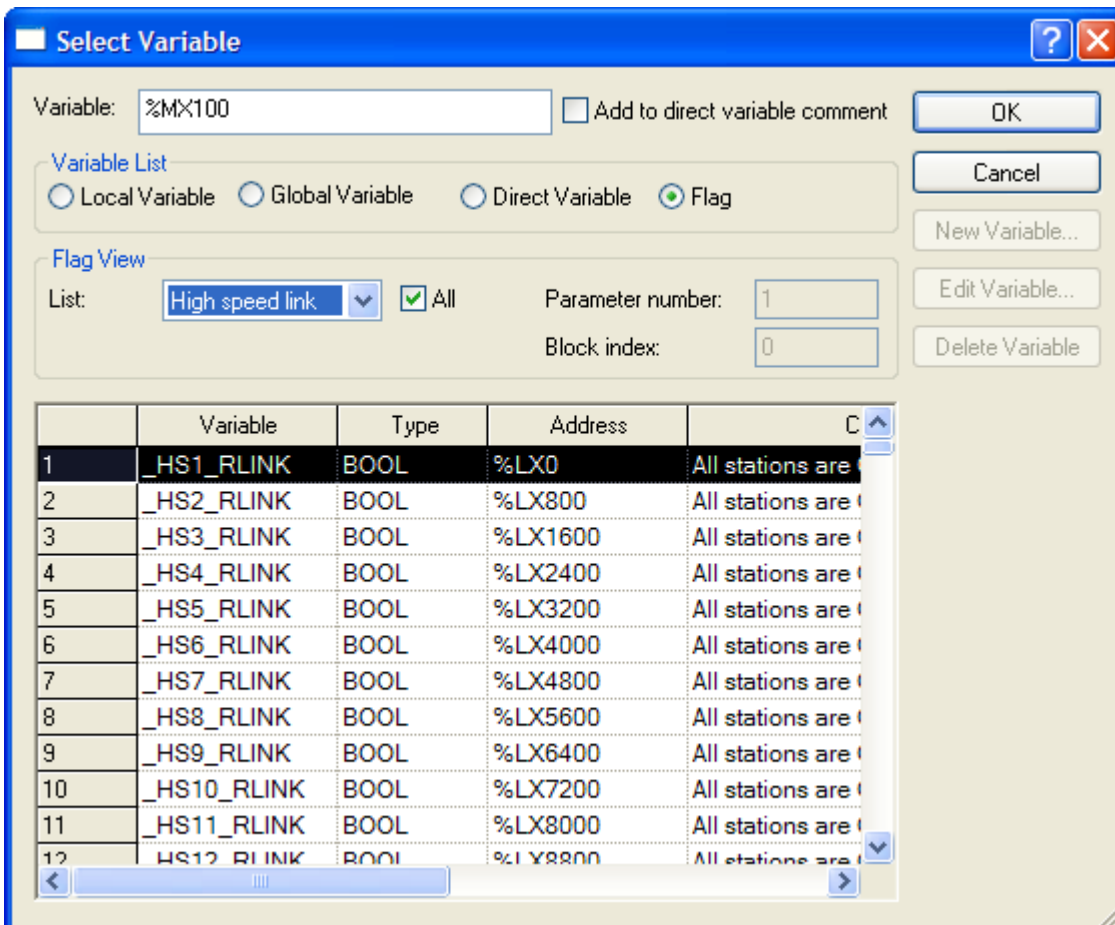

## Chapter 5 LD Edit

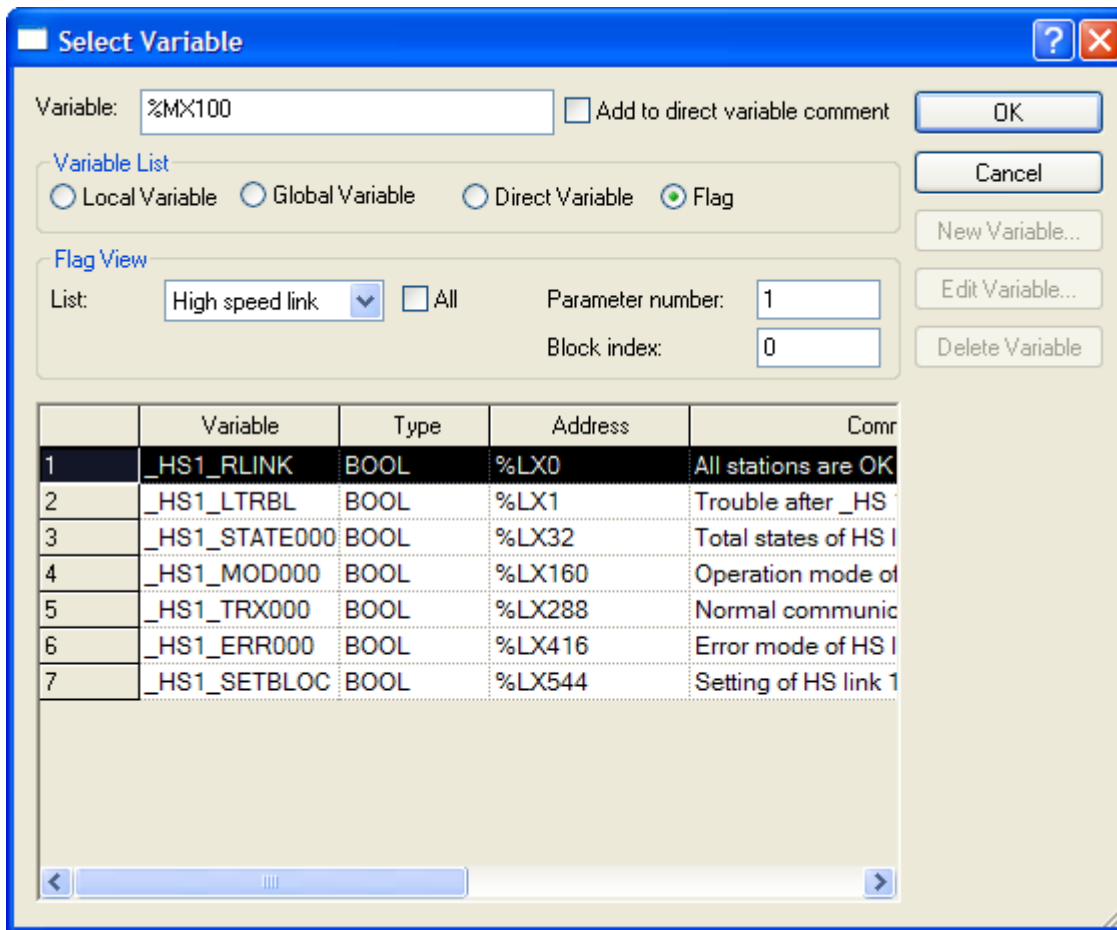

[Description of dialog box]

- Flag: displays flag at list. You can select detail type at flag view item
- List: as selection box displaying flag type, you can select System/High speed link/P2P/PID flag
- All: select whether to display all flag list of the select flag or flag list based on parameter number/block index.
- Parameter number: inputs setting number per the selected flag item. For high speed link, range is 0~12. For P2P, range is 0~8. For PID, range is 0~63. Those can be different according to PLC type
- Block index: inputs block number per the selected flag item. For high speed link, range is 0~127. For P2P, range is 0~63. Those can be different according to PLC type
- OK: applies the inputted or selected items and closes the dialog box
- Cancel: closes the dialog box

[Dialog box]

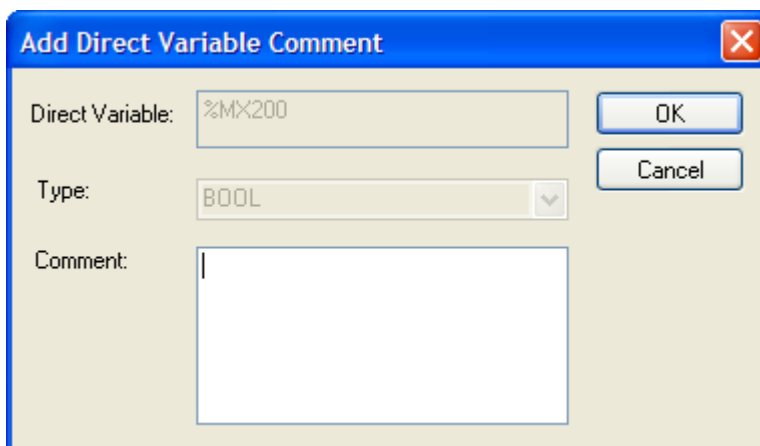
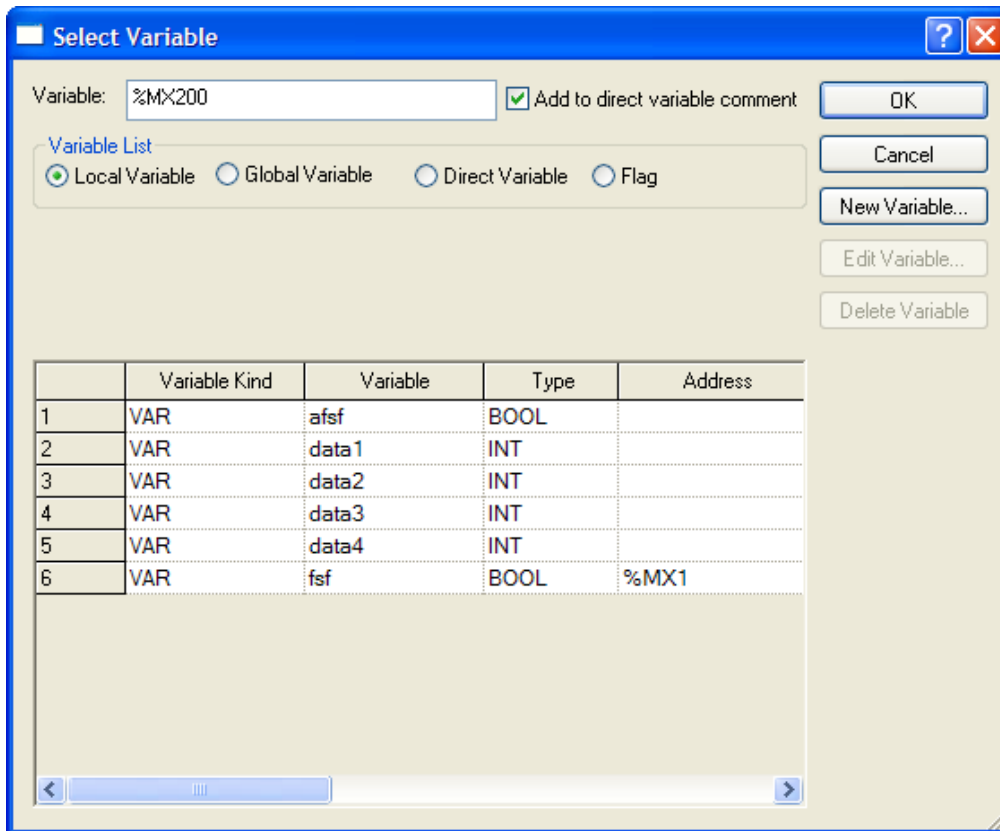

[Description of dialog box]

- Add to direct variable comment: In case the inputted variable is direct variable and there is no comment, recalls the dialog box to add the direct variable comment
- Direct Variable: displays the inputted direct variable
- Type: displays the type of direct variable
- Comment: inputs comment for direct variable
- OK: add to direct variable comment list and closes the dialog box
- Cancel: closes the dialog box.

[Dialog box]

The image shows a 'Variable Add' dialog box with the following fields and controls:

- Variable:** A text input field.
- Data Type:** A dropdown menu currently set to 'BOOL'.
- Variable Kind:** A dropdown menu currently set to 'VAR'.
- Address:** A text input field with a 'Settings...' button to its right.
- Initial Value:** A text input field with an 'Initialization...' button to its right.
- Trigger:** A dropdown menu and a 'Retain' checkbox.
- Description:** A large text area for entering a description.
- Buttons:** 'OK' and 'Cancel' buttons are located on the right side of the dialog.

[Description of dialog box]

- Variable: inputs variable name.
- Data type: select data type for variable
- Variable kind: select variable kind for variable
- Address: allocates the direct address for variable. In case data type is STRUCTURE, Settings button is activated. You can allocate memory for structure member.
- Initial Value: inputs initial value of variable. In case data type is array or structure, Initialization button is activated. You can input initial value for member for array or structure member
- Trigger: in case variable kind of user function block is VAR\_INPUT, you can set trigger status for variable
- Retain: inputs the Retain status for variable
- Description: inputs description for variable

### 5.2.5 Input Line

The horizontal line shall be inputted for horizontal connection between LD Edit factors, and the vertical line shall be for vertical connection.

#### 1) Horizontal Line Input

[Steps]

1. Move the cursor onto the location to connect to.

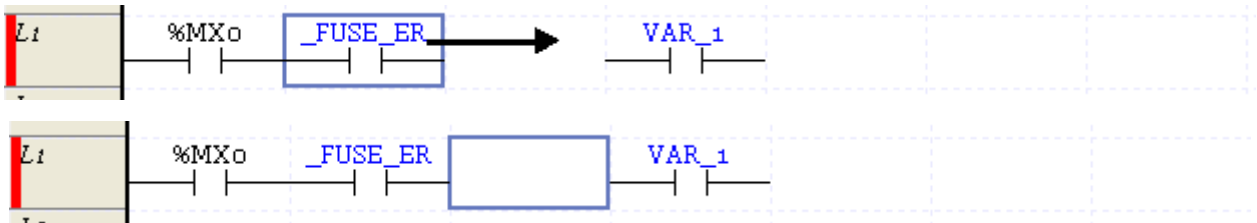

2. Select the Shortcut Key of Horizontal Line Input. Or select Horizontal Line on the tool box and select the Edit area to input the Horizontal Line in.

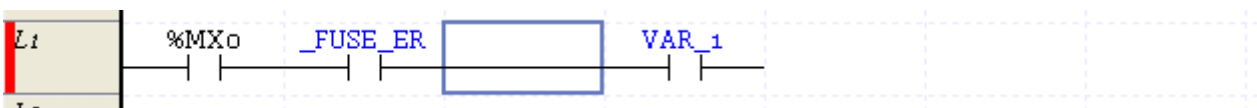

#### 2) Vertical Line Input

[Steps]

1. Move the cursor onto the location to connect to.

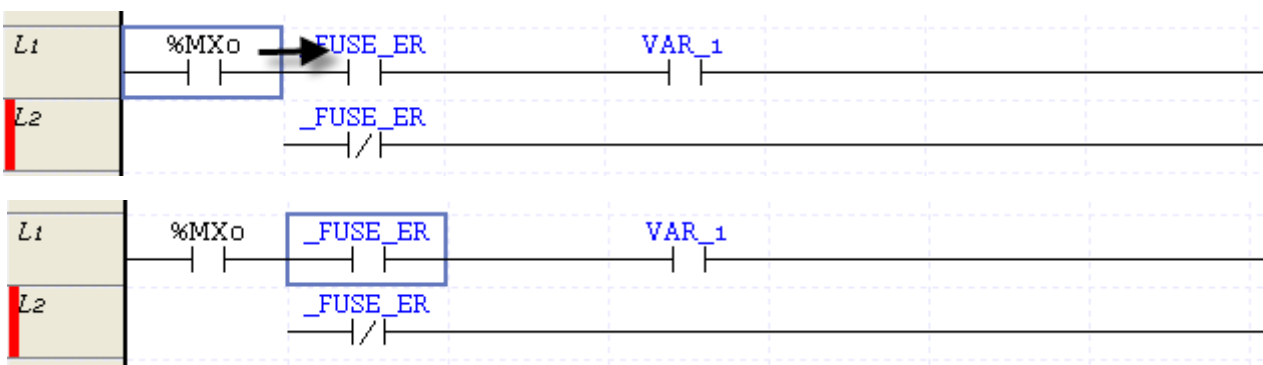

2. Select the Shortcut Key of Vertical Line Input. Or select Vertical Line on the tool box and select the Edit area to input the Vertical Line in.

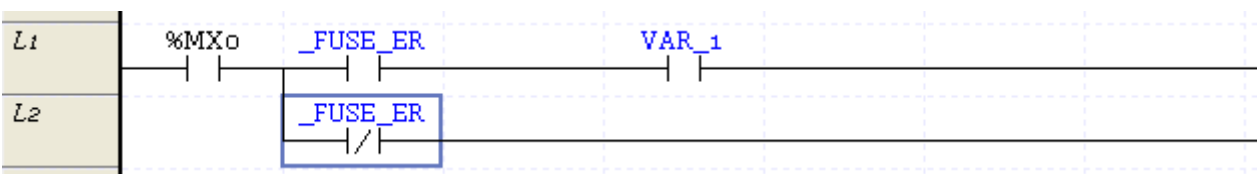

### Notes

- The vertical line will be inputted downward to the left from the location of the present cursor.

### 5.2.6 Input Coil

It is used to input the coils (coil, reverse coil, positive-conversion detection coil and negative-conversion detection coil).

[Steps]

1. Move the cursor to the location to input the coil on.

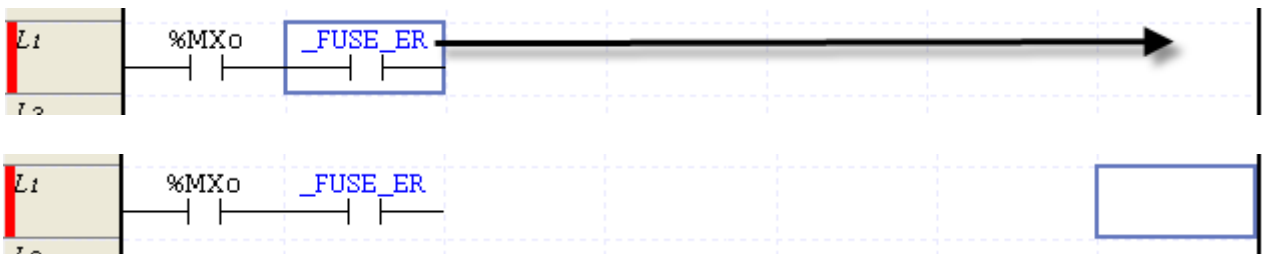

2. On the tool box, select the type of the coil to input and then click the edit area. Or click the Shortcut Key applicable to the coil to input.
3. After a variable name is input on the Variable Selection Dialog Box, click [OK].

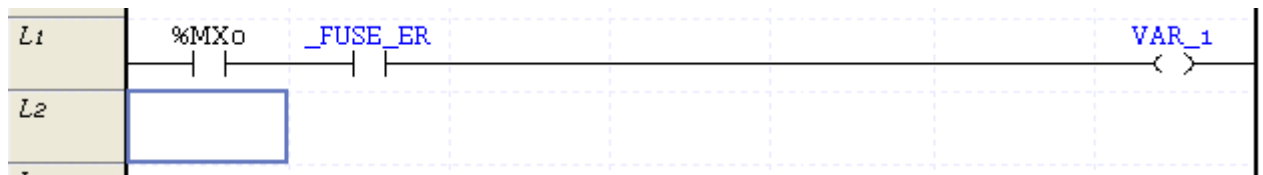

### Notes

- If a coil and output related application instruction is inputted, a horizontal line will be automatically inputted to connect with the left factor.
- When there is duplicate coil, outputs to output module according to last coil status.

### 5.2.7 Input Function (block)

Input a function(block) for operation.

[Steps]

1. Move the cursor to the location to input the function(block).

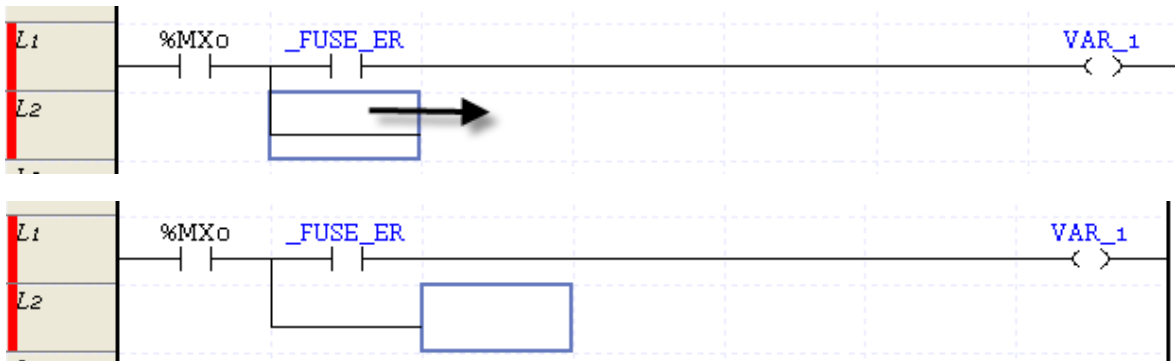

2. On the tool box, select the function(block) to input and then click the edit area. Or click the Shortcut Key applicable to the function(block) input

[Dialog Box]

Select a function.

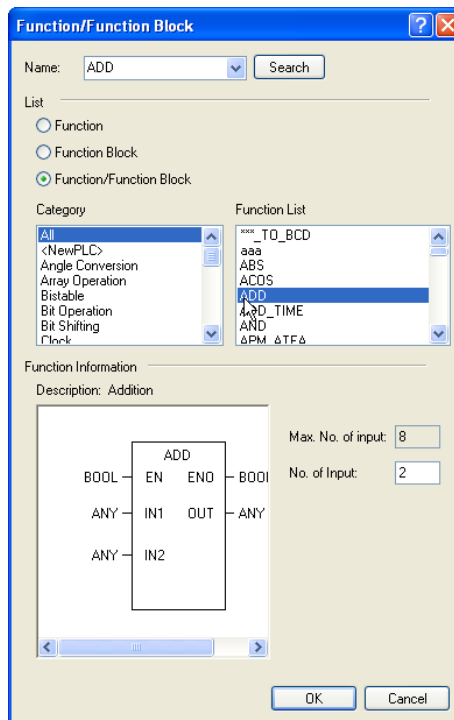



## Chapter 5 LD Edit

[Description of Dialog Box]

- a. Name: input a name of function(block) to use.
- b. Search: search a name of the input function(block)
- c. List: select whether to display a function, function block or both on the dialog box.
- d. Category: displays the categories of function(block).
- e. Function list: displays the list of function(block) of a selected category
- f. Function information: displays the information and properties of a function. In case of function, a user can set the properties of an input parameter; in case of function block, a user can select the name and class of an instance.
- g. OK: Applies the input details and closes the Dialog Box.
- h. Cancel: closes the Dialog Box.

3. On the Function(block) Input Dialog Box, input the function(block), and then click [OK].

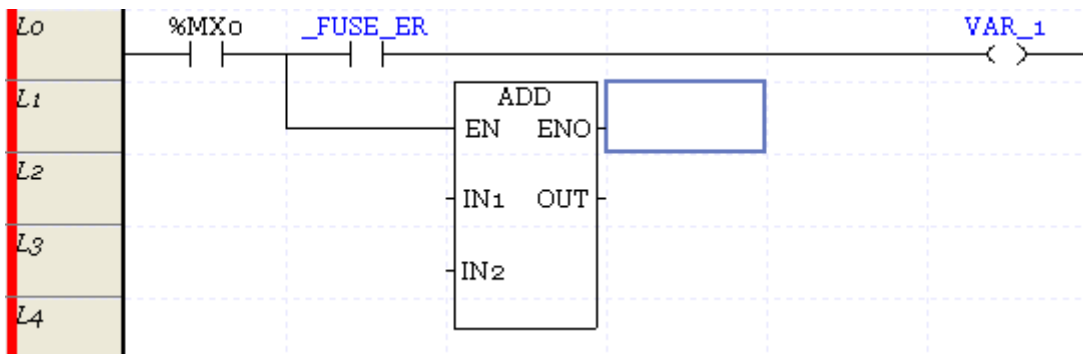

### Notes

- Refer to XGI CPU manual for details on the function (block).

### 5.2.8 Favorite Function (Block)

It displays a function(block) that is mostly used in the present project or is recently used. Or, a user can register a function to frequently use in the future.

1) Display of function(block)

[Steps]

1. Select [View]-[Instruction Window] on the menu.

## 2) Register Function(block)

When using a function(block), it is automatically registered. If the list is 'latest', it is registered on the top of the list. If a function is already added to the list, the item (function) is displayed on the top.

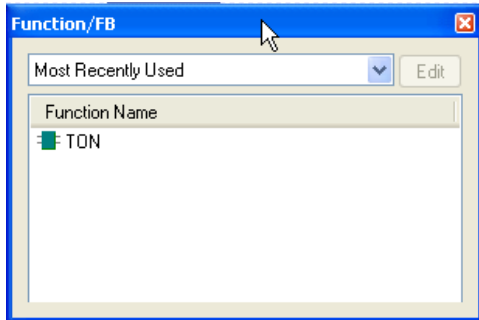

If the present list is 'Most Use', the top item is determined by the frequency of function (block) used.

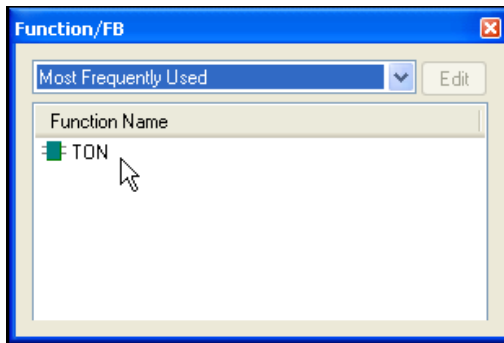

### Notes

- A function (block) is registered if the function(block) is selected on the function(block) input dialog box.
- A function copied or pasted does not affect the frequency and the recent use.
- If an input parameter is variable such as Function Add, the first used parameter's information is registered.

## Chapter 5 LD Edit

### 3) Register Favorite Function

It provides a method that a user registers a function(block) to frequently use in the project.

[Steps]

1. Select a 'Favorite Function' in the Selection box.

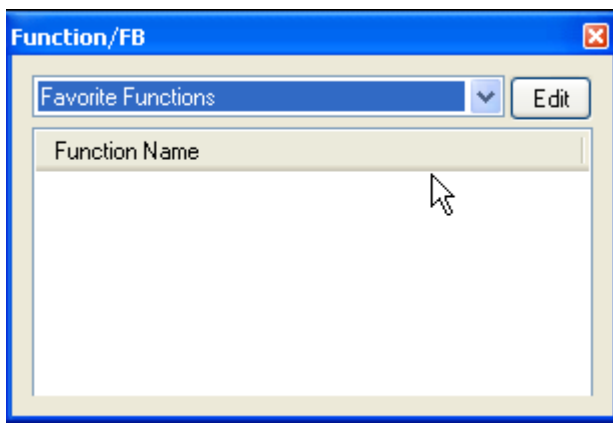

2. Edit the list of function by [Edit] button and close the dialog box.

[Dialog Box]

Edit the Favorite Function List.

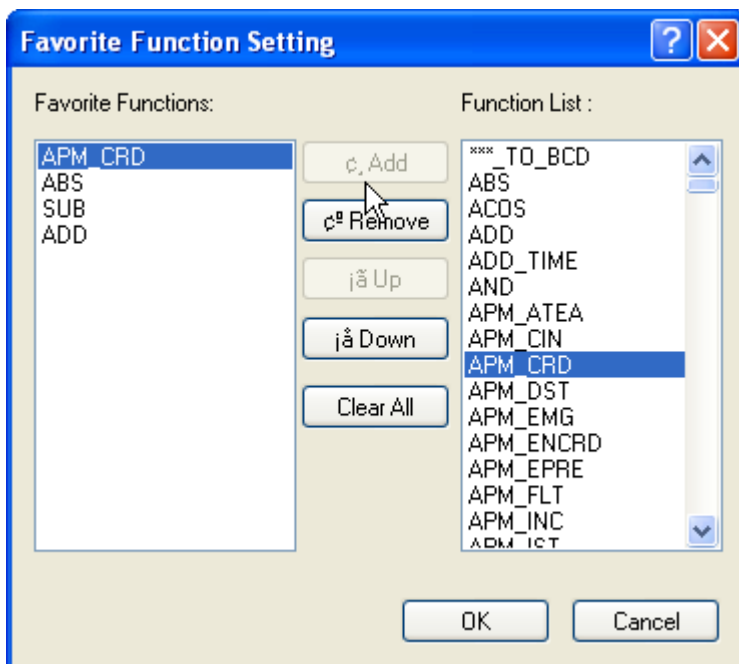

[Description of Dialog Box]

- a. Favorite Function: displays the presently selected function. The content displayed on the Favorite Function List is the content to be displayed in Command window.
- b. Function List: displays the list of function(block) available on the present project.
- c. Add: adds a selected function to the Favorite Function.
- d. Remove: deletes a selected function from the Favorite Function.
- e. Up: move a selected item to a higher level of the favorite function.
- f. Down: move a selected item to a lower level of the favorite function.
- g. Clear All: clears the present favorite function list.
- h. OK: checks changes and closes the dialog box.
- i. Cancel: closes the dialog box.

4) Use Function

Uses the function(block) on the list.

[Steps]

1. Move the cursor on the position to insert a function.

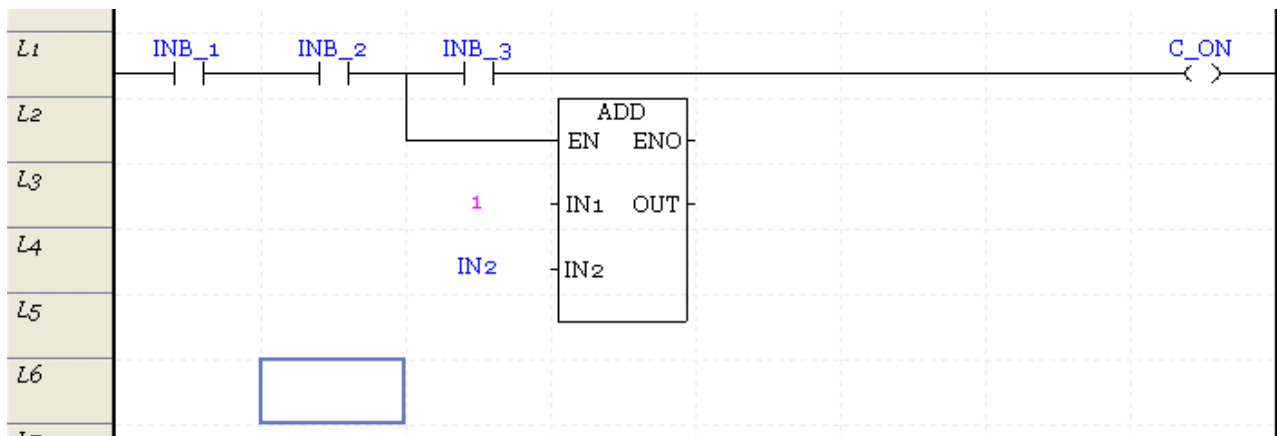

2. Double-click a command to insert in the Command Window.

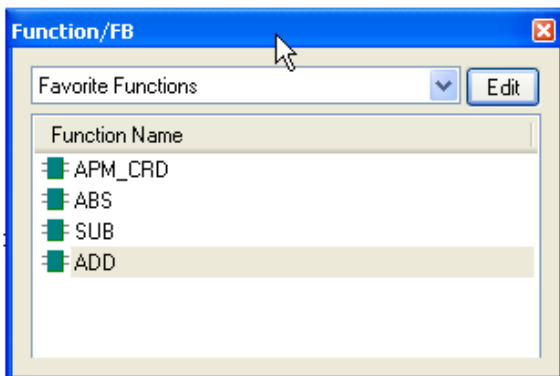

## Chapter 5 LD Edit

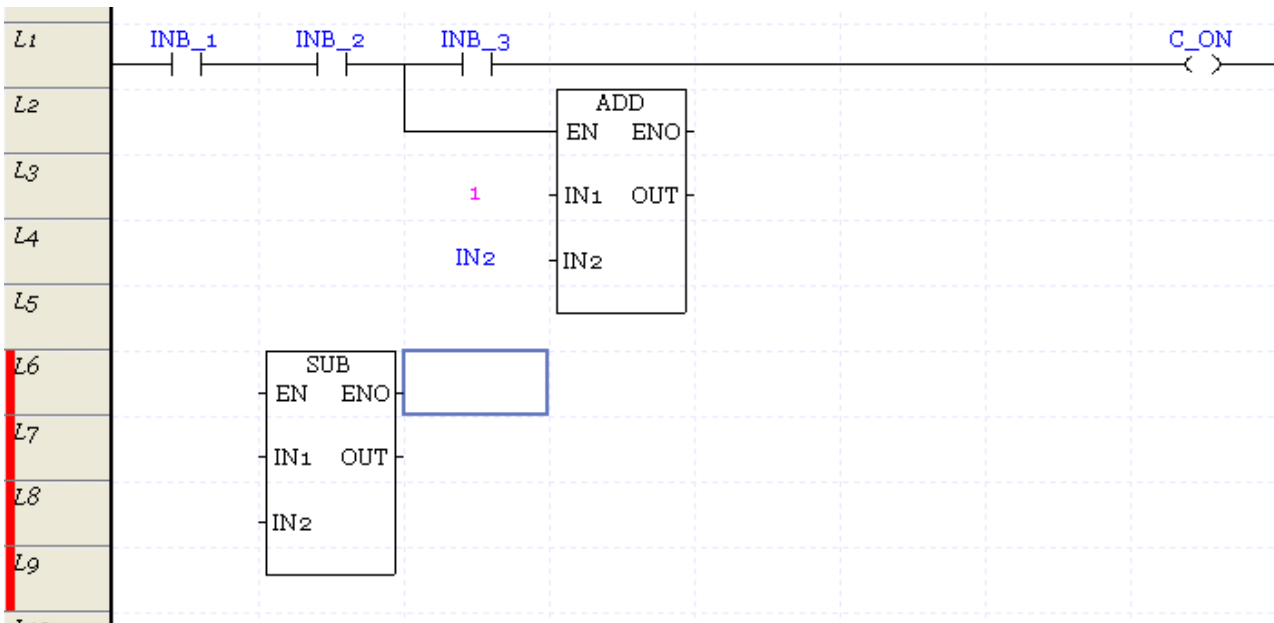

### Notes

- It is also possible to drag an item to insert in the Command Window and insert it to the LD program.

### 5.2.9 Input Comment

It is used to input the Rung and Output Comment. The comment displayed on the start position of Rung is called [Rung Comment], and the comment for the output factor is called [Output Comment].

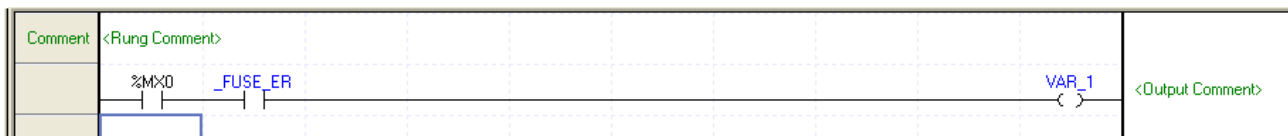

#### 1) Rung Comment

[Steps]

1. Move the cursor to the location to input the rung comment on.

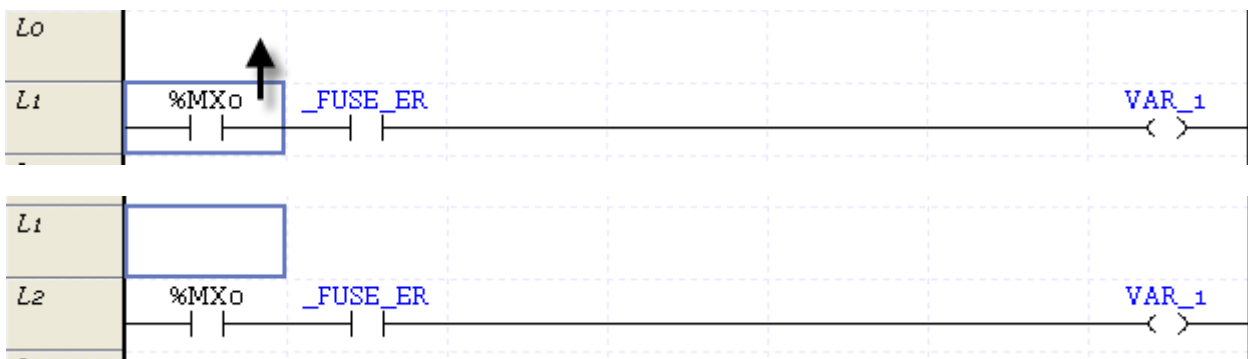

2. Select [Edit]-[Comment/Label Input].

[Dialog Box]

Input the Comment and Label.

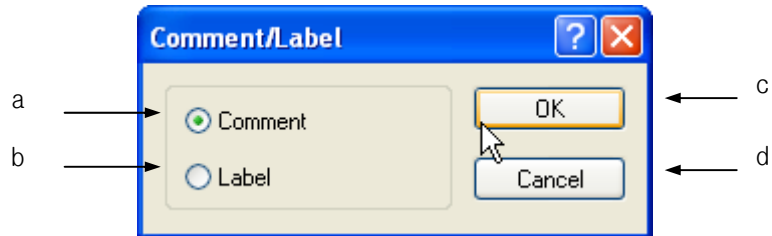

[Description of Dialog Box]

- a. Comment: used to select the Rung Comment to input.
- b. Label: used to select the Label to input.
- c. OK: applies the selected details and closes the Dialog Box.
- d. Cancel: closes the Dialog Box.

3. If the Rung Comment Dialog Box is displayed, input the comment and click [OK].

[Dialog Box]

Input or edit the Rung Comment or the Output Comment.

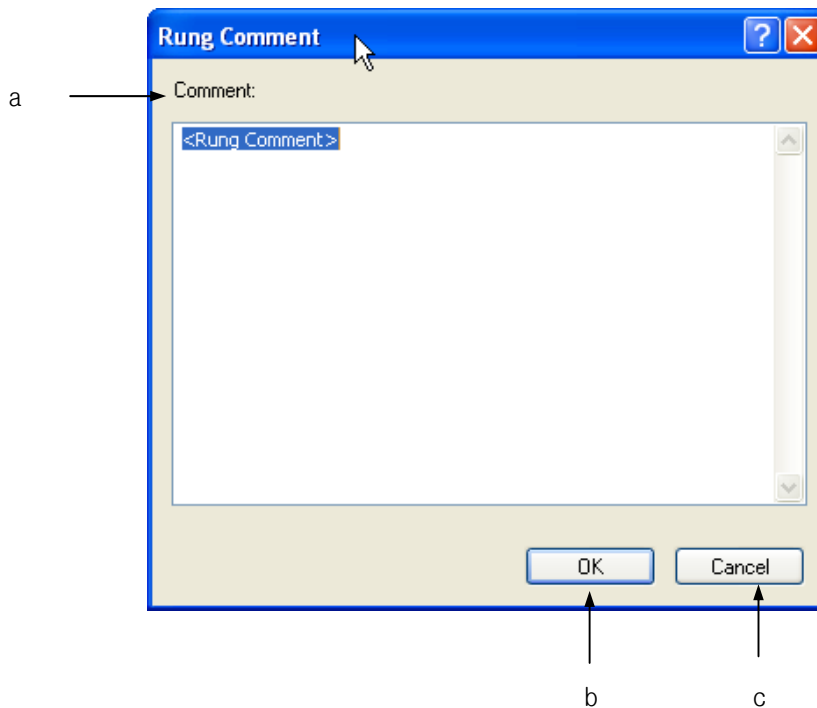

## Chapter 5 LD Edit

[Description of Dialog Box]

- Comment: used to input the details of the rung comment or the output comment.
- OK: applies the input details and closes the Dialog Box.
- Cancel: closes the Dialog Box.

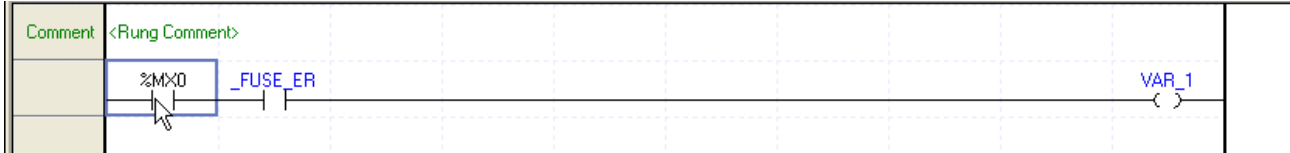

### 2) Output Comment

[Steps]

1. Move the cursor to the location to input the output comment on.

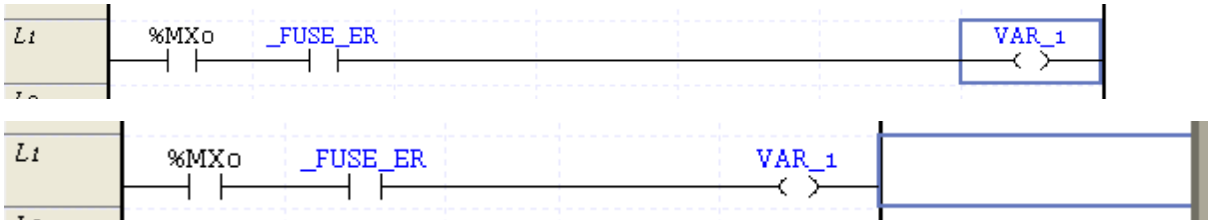

2. Double-click the left mouse button or press Enter key.

3. Input the output comment on the Output Comment Dialog Box and then click [OK].

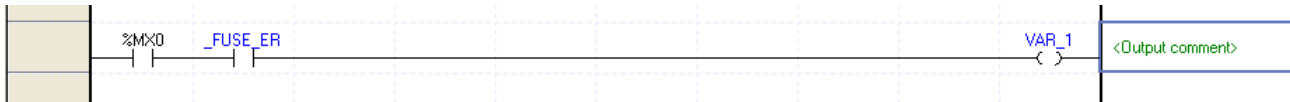

### Notes

- The output comment will be available to input only when the output factor exists.

### 5.2.10 Input Label

This is used to input the label to refer to from the extended function of JMP.

[Steps]

1. Move the cursor to the location to input the label on.

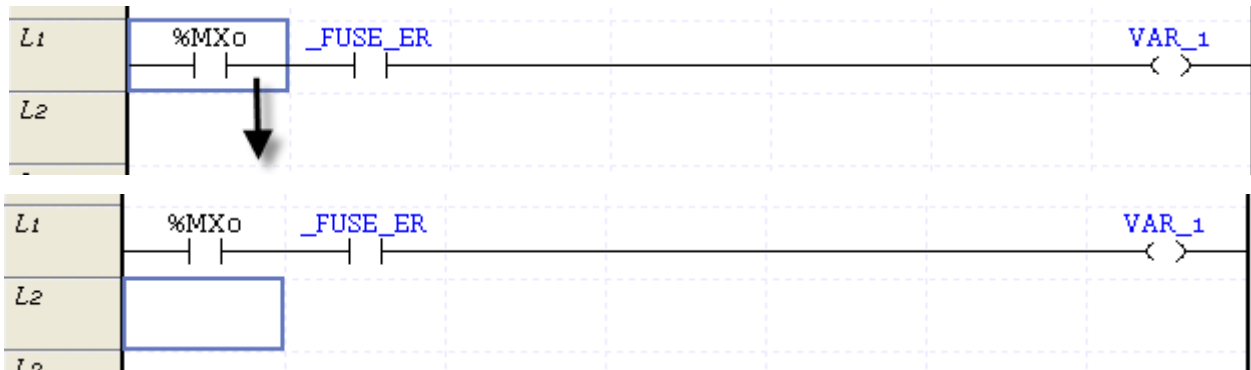

2. Select [Edit] – [Comment/Label Input].
3. On the Dialog Box, select Label and then press Enter or click [OK].

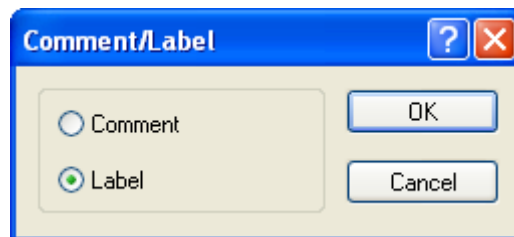

4. On the Label Dialog Box, input the label to add, and then click [OK].



[Dialog Box]

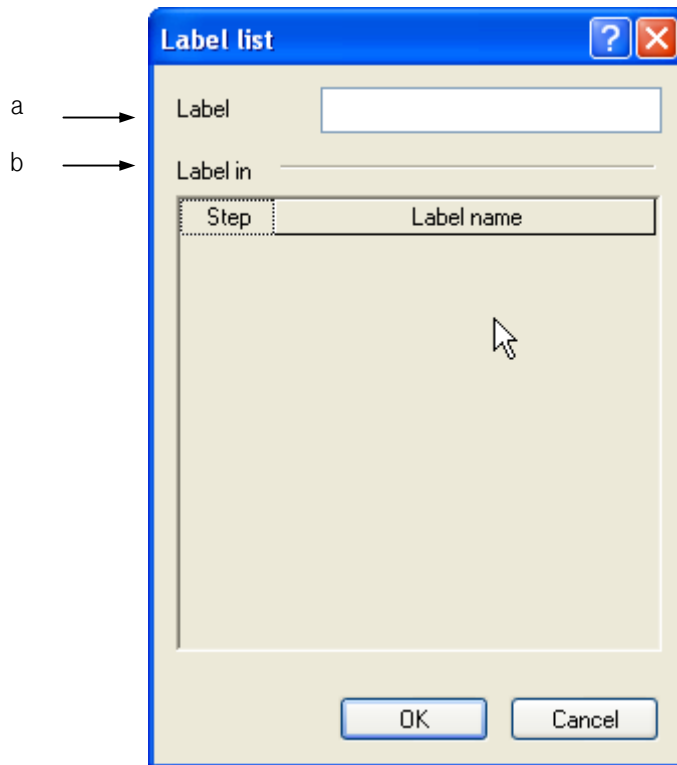

[Description of Dialog Box]

- a. Label: used to input the label to use.
- b. Label being used: used to display the label presently used in the same scan program. If selecting an item on the Label being used, the selected item is input.

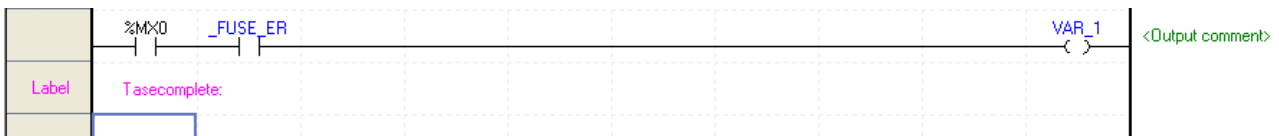

### Notes

- Up to 16 characters in English(8 in Korean) is available for the label.
- Capital/Small letters are sorted out for the label. The first letter of the label can not be a figure or a special character.
- Label Input rules shall conform to the Variable/Comment Input rules. Refer to 4.2.1 in Chapter 4 Variable/Comment for details on the Variable/Comment Input rules.

### 5.2.11 Insert Extended Function

It is used to insert the extended function such as insert/call subroutine and program end.

[Steps]

1. Move the cursor to the position to insert an extended function.

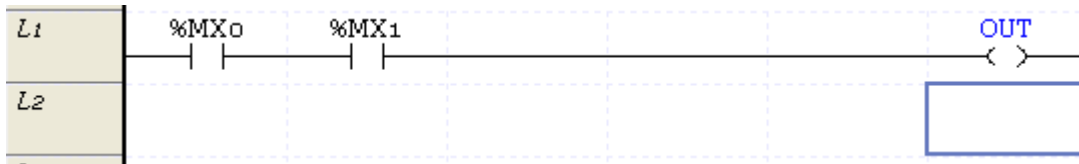

2. Select [Edit]-[Tools]-[Extended Function] on the menu.
3. Select an extended function to insert and click OK.

[Dialog Box]

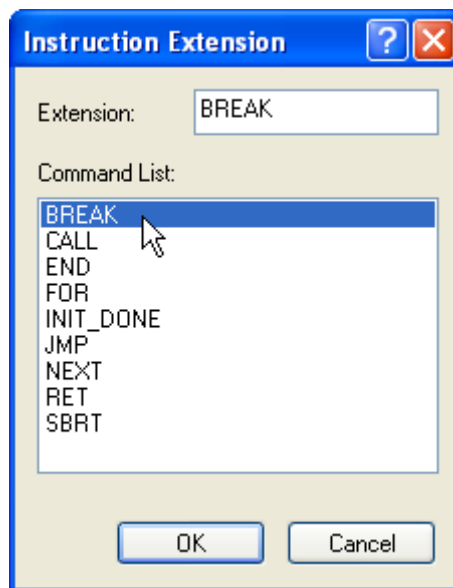

[Comment of Dialog Box]

- a. Extended Command: inputs an extended function or displays the input extended function.
- b. List of Commands: displays the available extended function.
- c. OK: applies a selected item and closes the Dialog Box.
- d. Cancel: closes the Dialog Box.

#### Notes

- Extended commands, SBRT and RET can not be inserted at LD used in SFC Action and Transition.

### 5.2.12 Insert Cell

It is used to insert a new cell in the present cursor position.

[Steps]

1. Move the cursor to the location to insert the cell in.

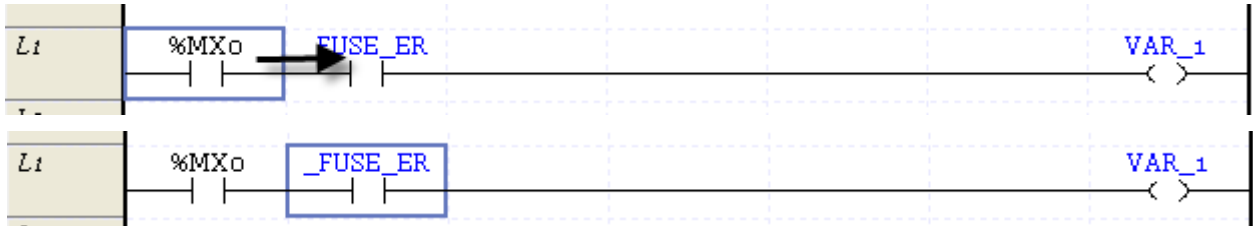

2. Select [Edit] - [Cell Insert].

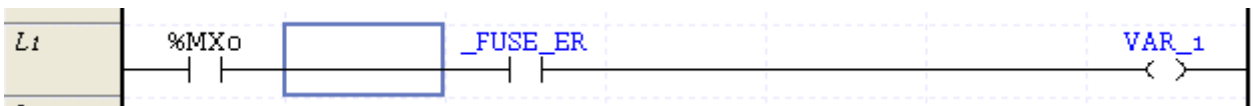

**Notes**

- If inserting a cell in Function(Block), a variable is also moved together.

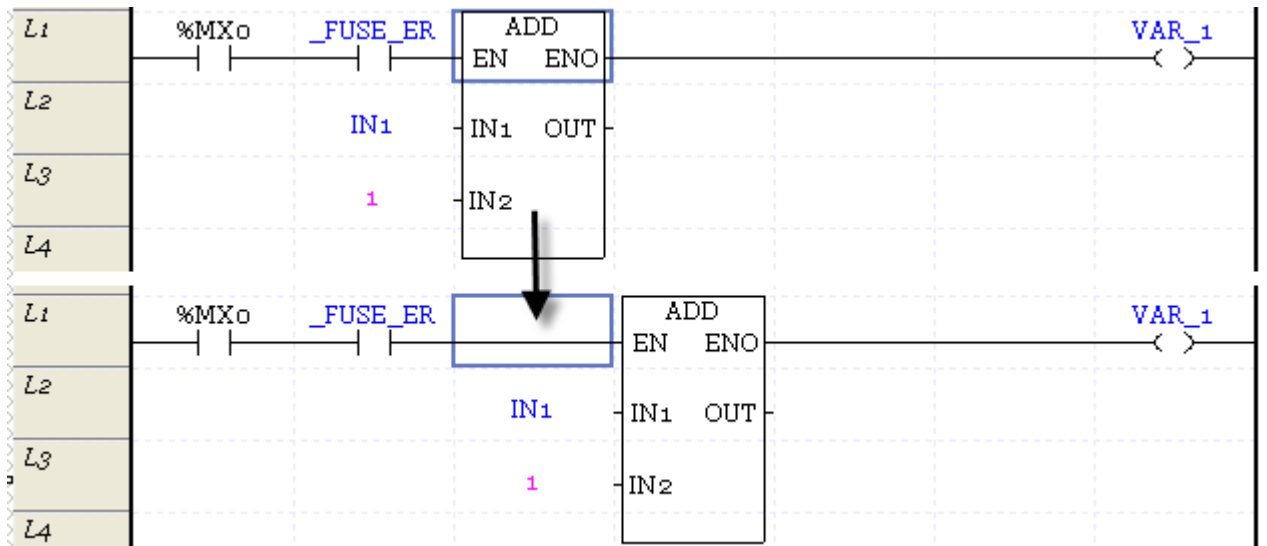

### 5.2.13 Insert Line

It is used to insert a new line in the present cursor position.

[Steps]

1. Move the cursor to the location to insert the line in.

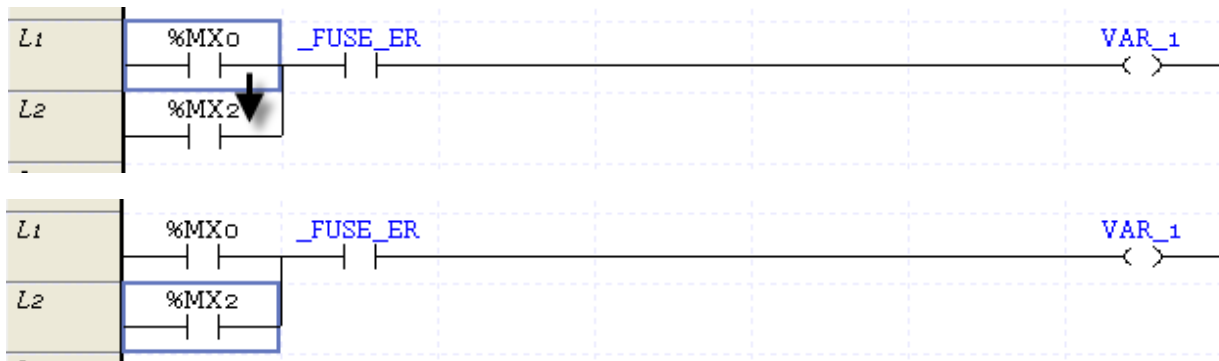

2. Select [Edit] - [Line Insert].

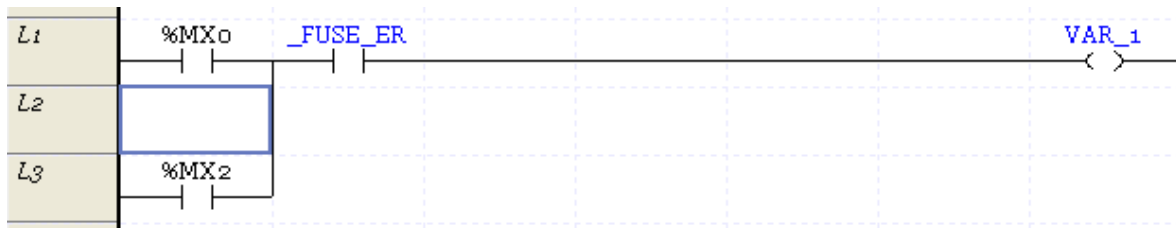

#### Notes

- If Line Insert is executed, a new line will be inserted in the present cursor position.
- If an area is selected for Line Insert, new lines as many as the lines in the selected area will be inserted.
- If function (block) is contained, line can not be inserted.

### 5.2.14 Delete Factor

It is used to delete the input contact point, coil, function (block), line, rung/output comment and label.

[Steps]

1. Move the cursor to the location to delete the factor from.
2. Select [Edit] - [Delete].

## Chapter 5 LD Edit

### Notes

- If deleting Function(block), the variable used as input/output is also deleted.

### 5.2.15 Delete Cell

It is used to delete the factors such as the input contact point and horizontal line to draw in the next cell.

[Steps]

1. Move the cursor to the location to delete the cell from.

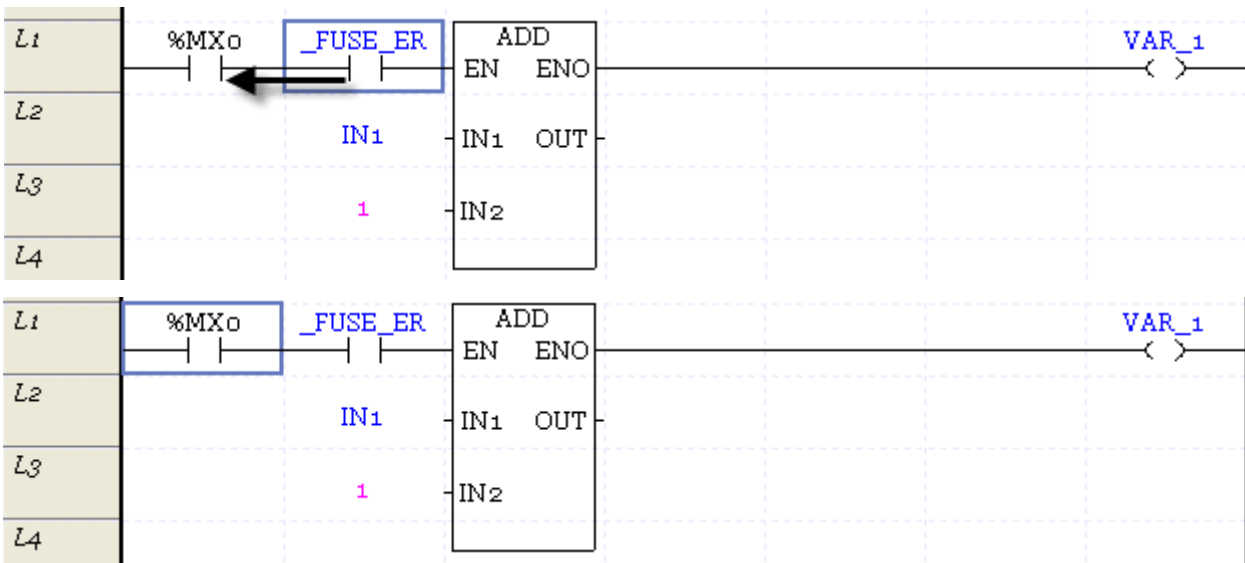

2. Select [Edit] – [Delete Cell].

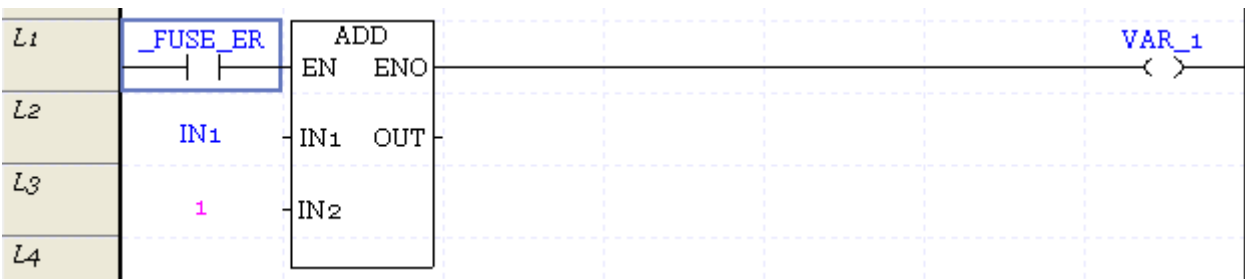

### Notes

- If there is no data where the cursor is positioned, Delete Cell is operated by pressing Delete. Therefore, if there is data, Delete Cell operates after deletion if pressing Delete twice.

### 5.2.16 Delete Line

It is used to delete all the lines in the selected area.

[Steps]

1. Move the cursor onto the line to delete.

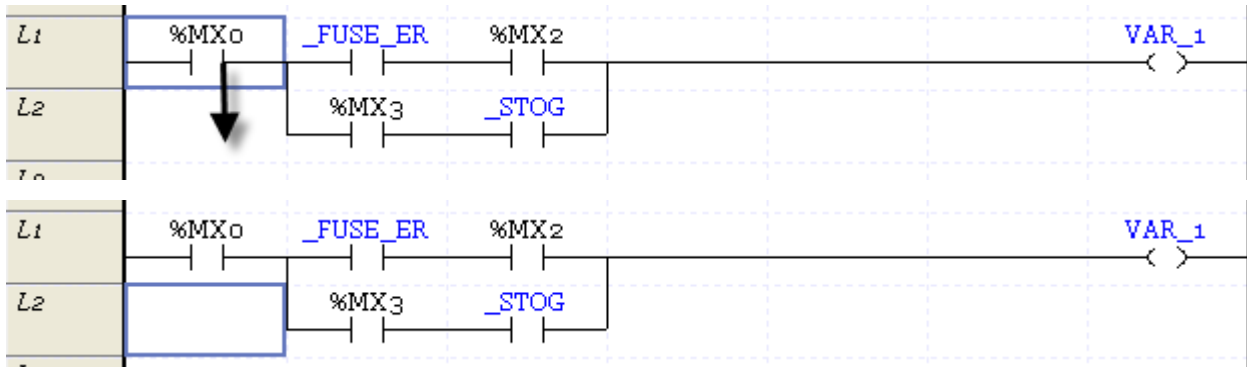

2. Select [Edit] - [Delete Line].

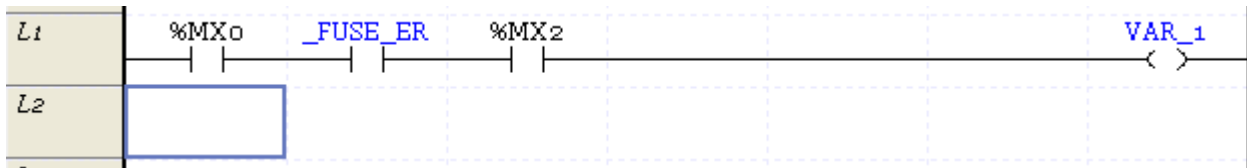

### 5.2.17 Copy/Cut/Paste

It is used to copy the data in the selected area, or cut the data to copy on the specified position. Differently from [Copy], [Cut] is used to delete the data in the presently selected area.

- 1) Copy

[Steps]

1. Select the area to copy.

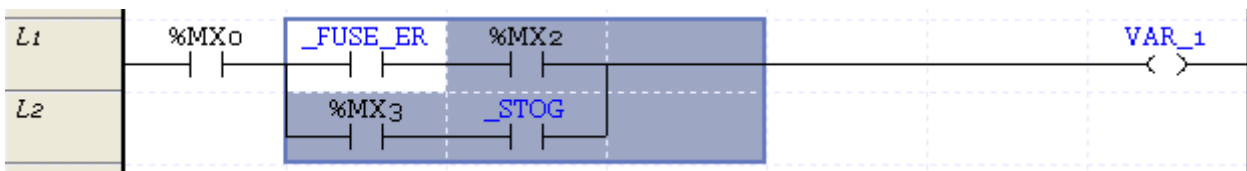

## Chapter 5 LD Edit

2. Select [Edit] - [Copy] on the menu.
3. Move the cursor to the area to paste on.

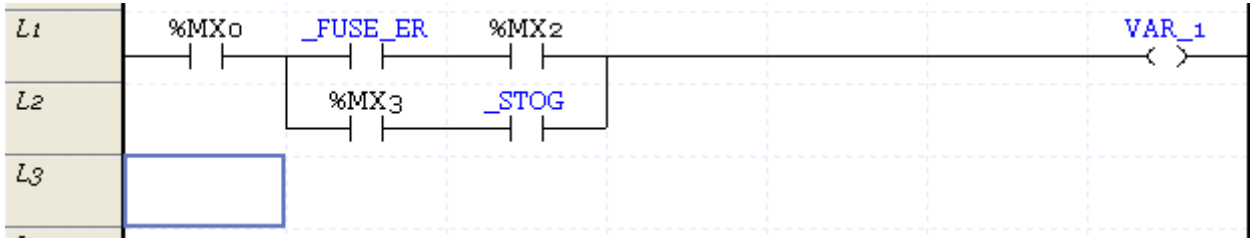

4. Select [Edit] - [Paste] on the menu.

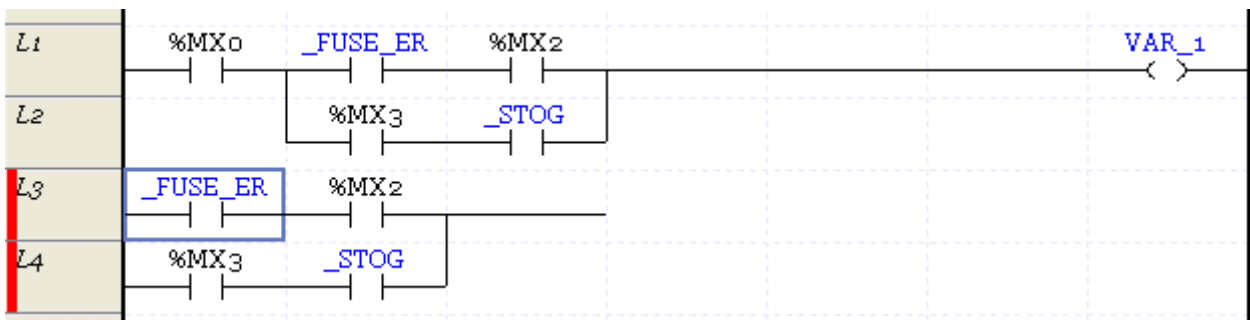

### 2) Cut

[Steps]

1. Select the area to cut.

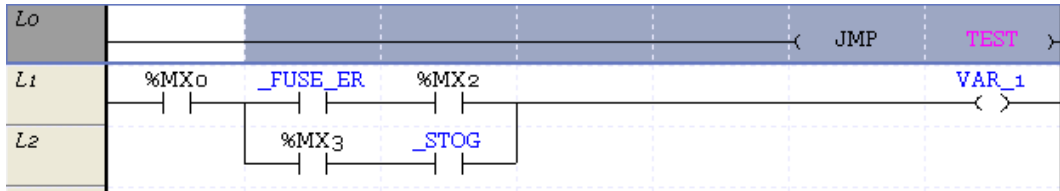

2. Select [Edit] - [Cut] on the menu.

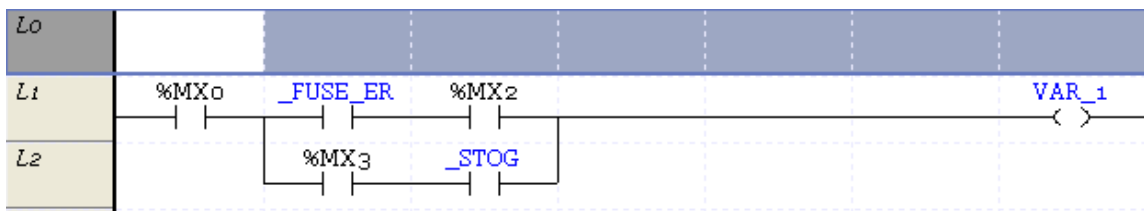

3. Move the cursor to the area to paste on.

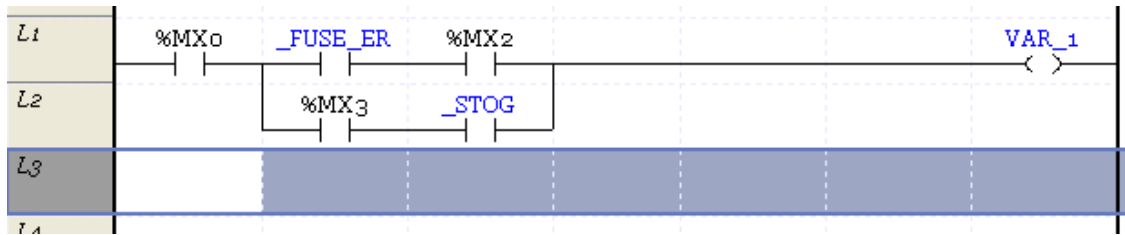

4. Select [Edit]-[Paste] on the menu.

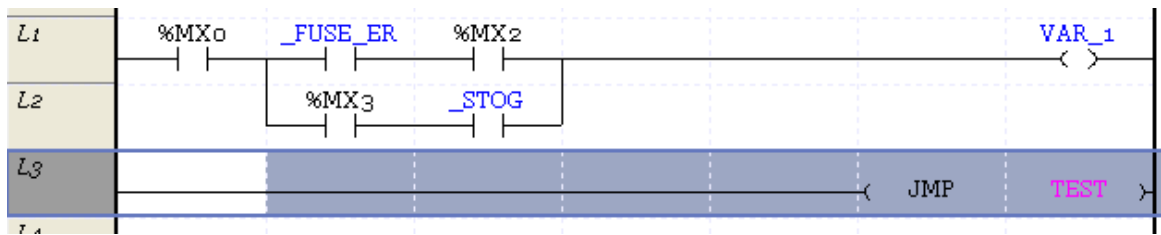

### 5.2.18 Undo and Redo

It is used to Undo the details edited by Program Edit back to its previous state, or execute again the details cancelled.

1) Undo (example of Delete)

[Steps]

1. Move the cursor onto the position to delete.

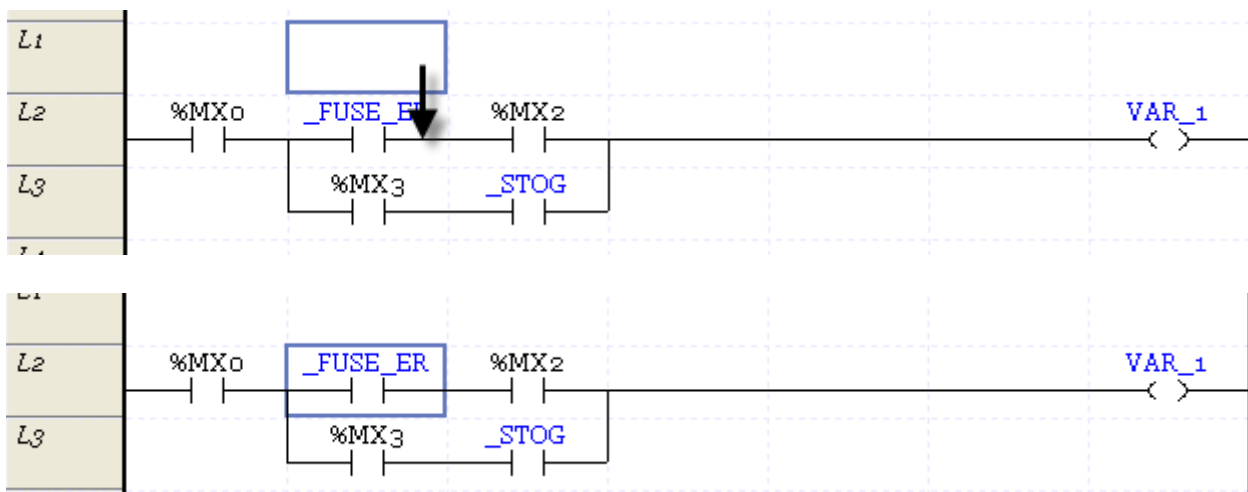



## Chapter 5 LD Edit

2. Select [Edit] - [Delete] on the menu.

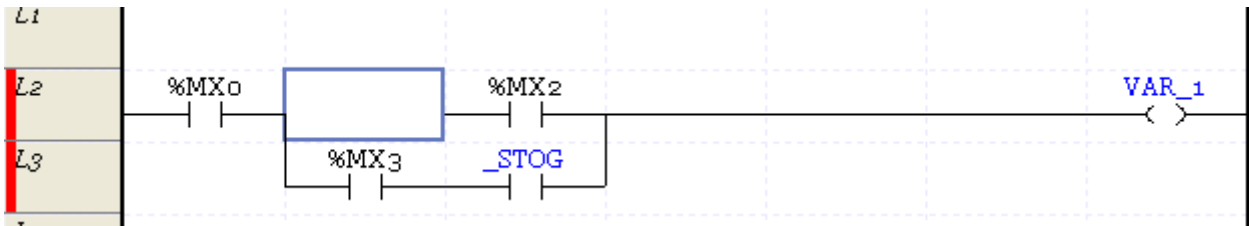

3. Select [Edit] - [Undo] on the menu.

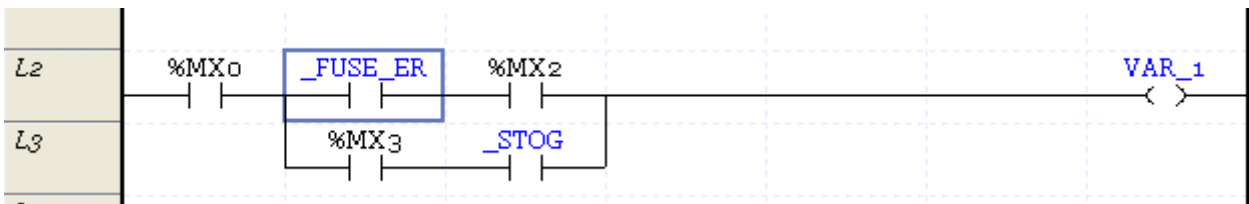

2) Redo (example of Delete)

1. Select [Edit] - [Redo].

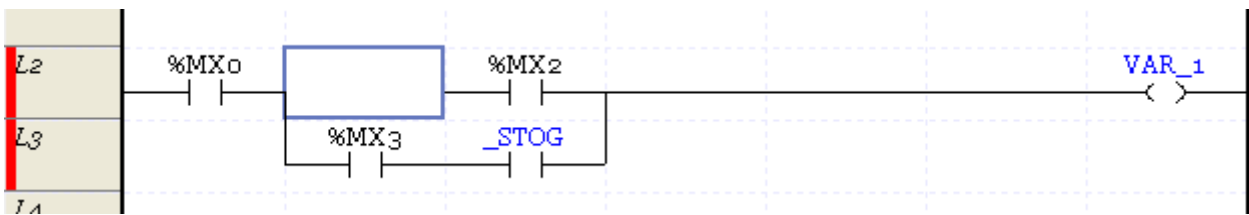

### Notes

- All the edited details can be cancelled or executed again.
- The number of times to cancel the execution is unlimited.

### 5.2.19 Program Edit Mode

LD Program supports two modes; Insert Mode and Overwrite mode. It is applied when inserting a contact point or function(block).

Insert mode:

Overwrite mode:

1) If inserting a contact point

Overwrite mode: if inputting a different type of contact point, the only contact point type is changed with the input device or variable remained (it does not work if a same type contact point is selected).

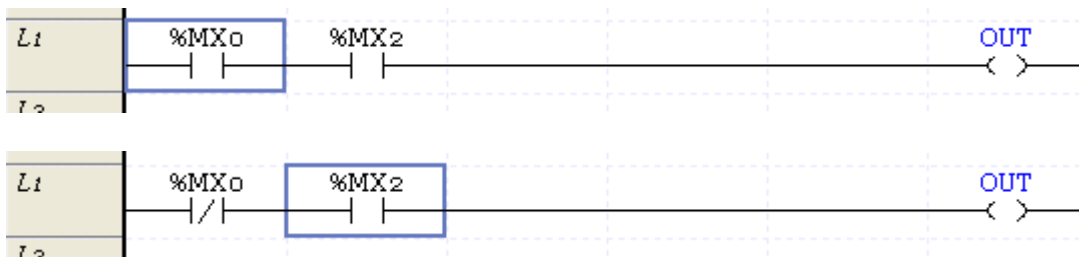

Insert mode: always inserts a new contact point to a designated position, regardless of contact point type. Insertion operation is as same as Insert Cell.

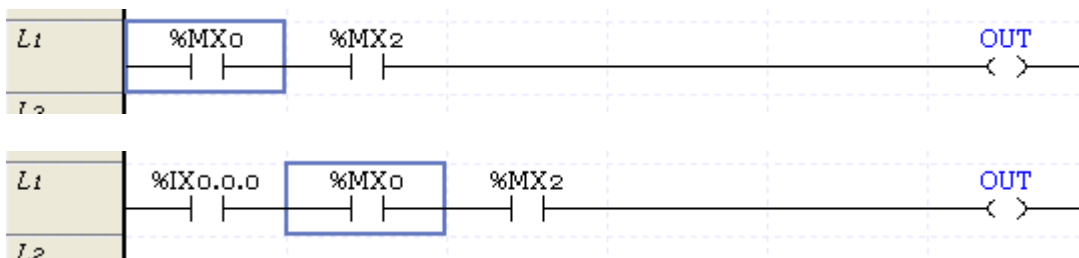

2) If inserting a function (block)

Overwrite mode: inserts a function (block) into the present position.

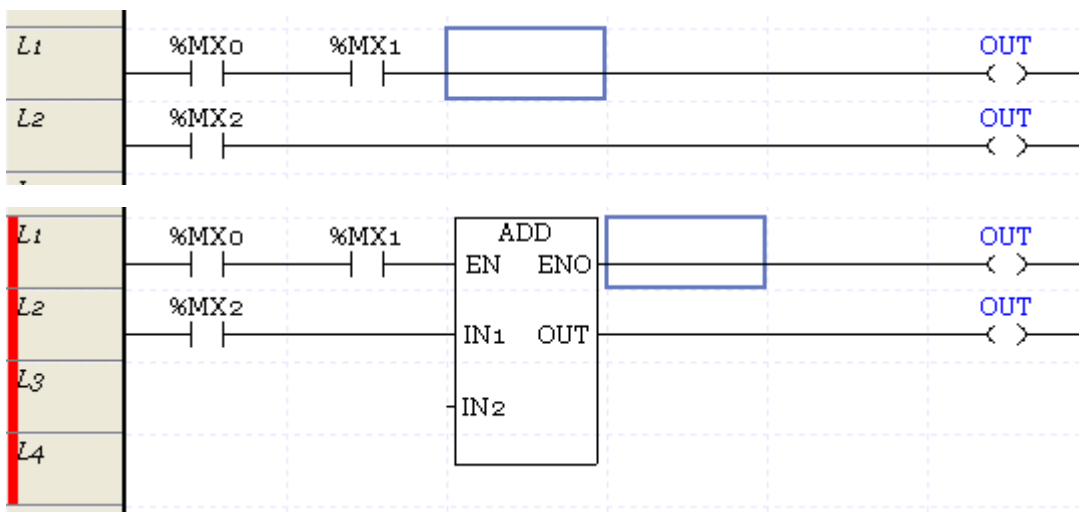

Insert mode: it inserts a space as high as a function (block) if there is not enough space to insert the function. Insert Space is as same as Insert Line.

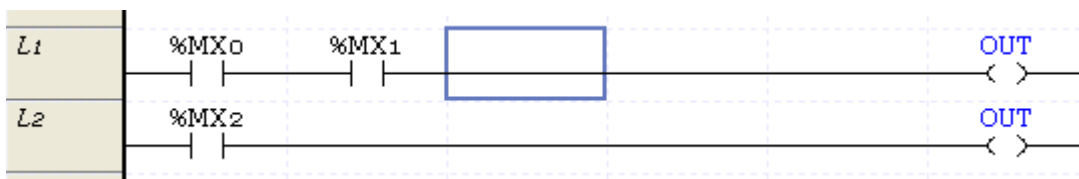

## Chapter 5 LD Edit

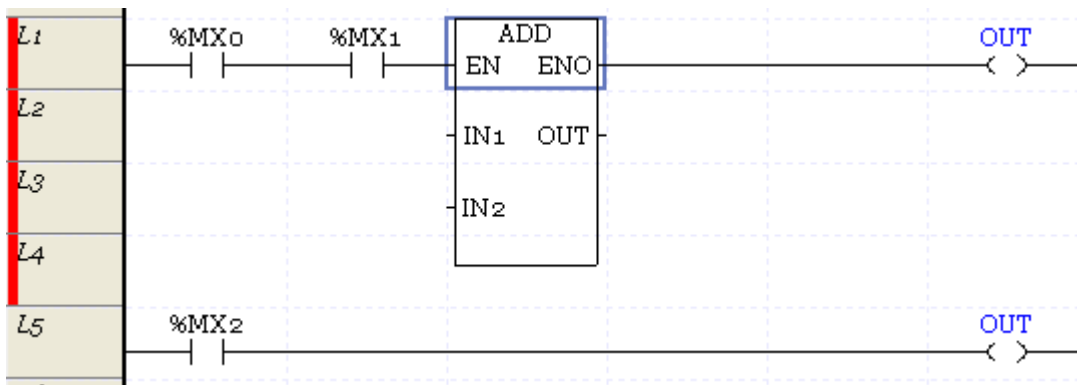

### 5.3 View Program

It is used to specify the Program View options.

#### 5.3.1 View IL Program

It is used to convert the LD program to the IL program and displays with the IL program.

[Steps]

1. Select the program.

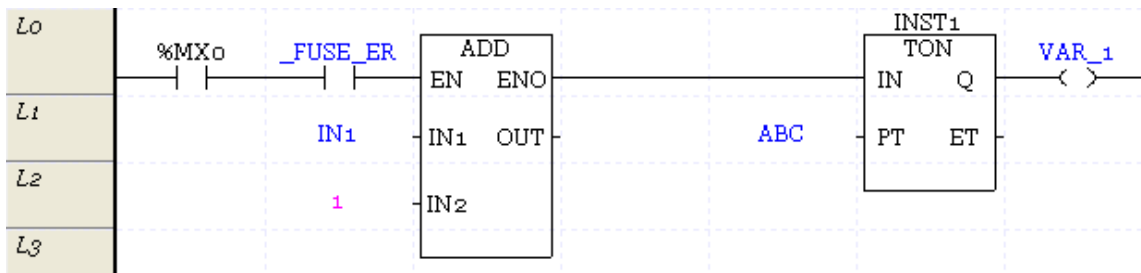

2. Select [View] - [IL].

Number	Instruction	Parameter	Variable	Variable Comment
1	LOAD		%MXD	
2	AND		_FUSE_ER	
3	ADD2_SINT			
4		EN:=	^LINEIN	
5		IN:=	IN1	
6		IN=>	1	
7		END=>	^LINEOUT	
8		OUT=>	^EMPTY	
9	TON	INST		
10		IN:=	^LINEIN	
11		PT:=	ABC	
12		Q=>	^LINEOUT	
13		ET=>	^EMPTY	
14				
15	OUT		VAR_1	

#### Notes

- If any incomplete rung exists, the LD program can not be converted to IL program.
- Edit is not possible in IL View

### 5.3.2 Program Magnification Change

This is used to change the magnification of the LD program displayed on the screen.

1) Zoom-In

[Sequence]

1. Select [View]-[Zoom-In] on the menu.

2) Zoom-Out

[Sequence]

1. Select [View]-[Zoom-Out] on the menu.

#### Notes

- Ctrl + Upward Wheel if available perform Zoom-Out step by step.
- Ctrl + Downward Wheel if available perform Zoom-In step by step.
- On the View Tool selection box, the user can select or directly input the magnification. Refer to 2.2 Tool Box in Chapter 2 Basic Application for more details.



## 5.3.3 View Device

It is used to display only the name of the device for the variable or device used as the contact point, coil and function(block). If there is no device, it displays a name of variable.

[Steps]

1. Select [View]-[Devices].

	Variable Kind	Variable Name	Type	Memory Address	Initial Value	Retain	Used	Comment
1	VAR	C_ON	BOOL	%QX0.0.1		<input type="checkbox"/>	<input type="checkbox"/>	
2	VAR	INB_1	BOOL	%MX0		<input type="checkbox"/>	<input checked="" type="checkbox"/>	
3	VAR	INB_2	BOOL	%MX1		<input type="checkbox"/>	<input checked="" type="checkbox"/>	
4						<input type="checkbox"/>	<input type="checkbox"/>	

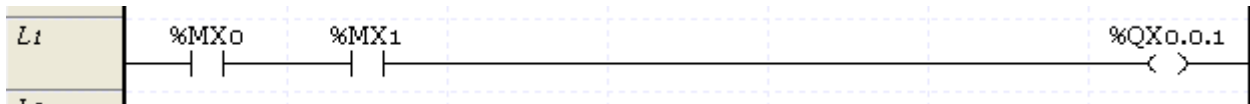

## 5.3.4 View Variable

It is used to display the name of the variable for the variable or device used as the contact point, coil and function(block).

If no variable is declared for the device, it will be displayed as the device name.

[Steps]

1. Select [View]-[Variable].

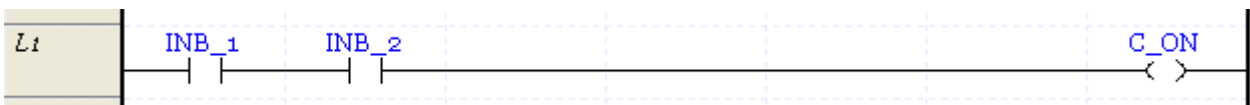

## 5.3.5 View Device/Variable

It is used to display the name of the device/variable for the variable or device used in the contact point, coil and function(block).

If there is no device in the variable, the variable name only will be displayed.

[Steps]

1. Select [View]-[Devices/Variables] Item.

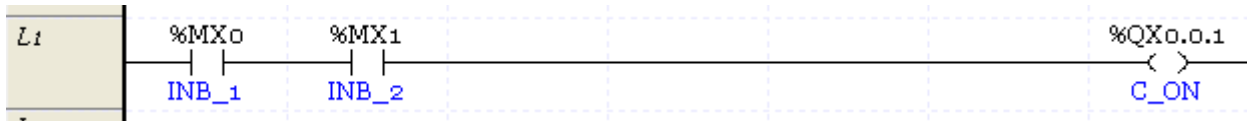

### 5.3.6 View Device/Comment

It is used to display the device/comment for the variable or device used in the contact point, coil and function(block).

If there is no device in the variable, the variable name only will be displayed.

[Steps]

1. Select [View]-[Devices/Comments] Item.

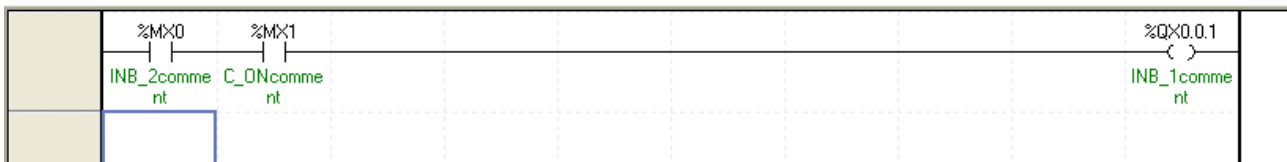

#### Notes

- If View Options are changed, it may take some time according to the amount of the edited program steps
- Print function of the Device/Variable/Comment is available. For the details of print option, refer to Chapter 14. Print.

### 5.3.7View Variable/Comment

It is used to display the variable/comment for the device used as the contact point, coil and Function (Block).

[Steps]

1. Select [View]-[Variable/Comment]

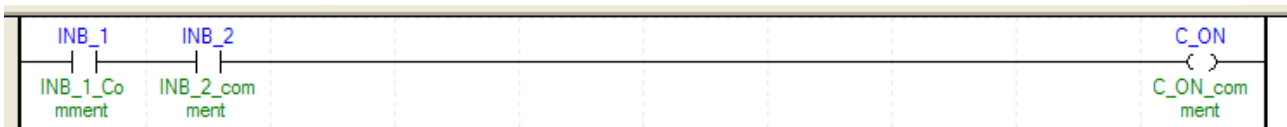

## Chapter 5 LD Edit

### Notes

- If View Options are changed, it may take some time according to the edited program amount.
- Print function of the Device/Variable/Comment is available. For more detail, refer to CH14.

### 5.3.8 Adjust No. of Contact Point

It is used to adjust the number of contact points displayed in the screen. Here, the number of contact points is total number (horizontal cell - 1), excluding the output position.

[Steps]

1. Select [View]-[Change Columns]-[Increase Columns] on the menu.

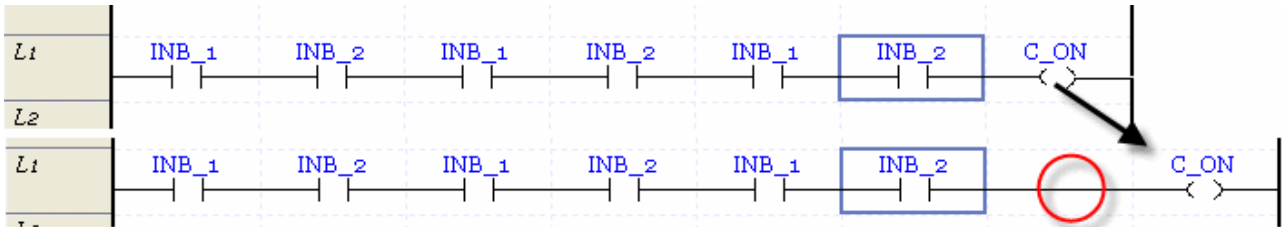

If the data in the very right of the present screen is larger than the number of contact points to display, it may be displayed by rung including arrow.

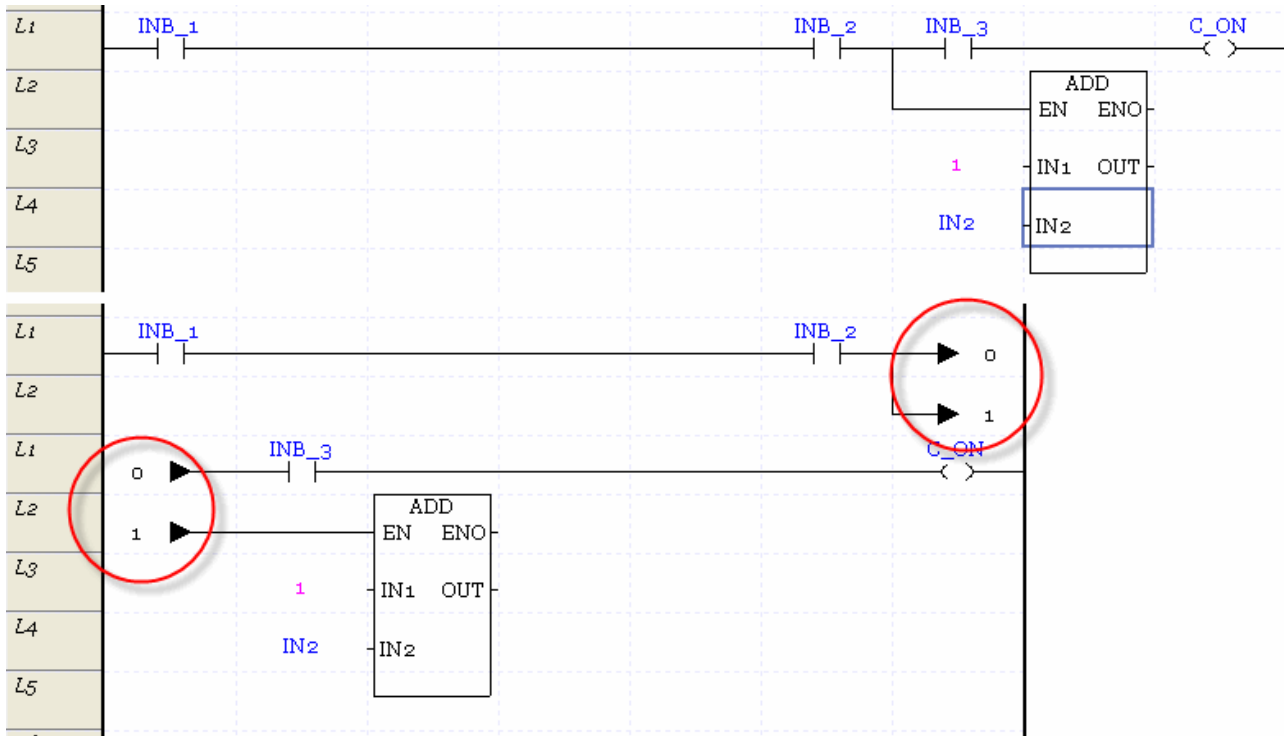

## Notes

- It may increase or decrease one by one in [View]-[Toolbox]

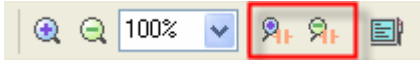

- The number of contact to set is 9 ~ 32.
- The number of contact points minimally set in LD program used for SFC action and transition is 5.

### 5.3.9 LD Screen Properties

It is used to designate the properties of View LD Screen. In the screen properties, the options of device, variable and comment view can be set while magnification and the number of contact points can be set simultaneously. In addition, the same properties for the entire LD screen can be also set.

[Steps]

1. Select [View]-[LD Properties] on the menu.
2. Change the LD screen properties and click OK.

[Dialog Box]

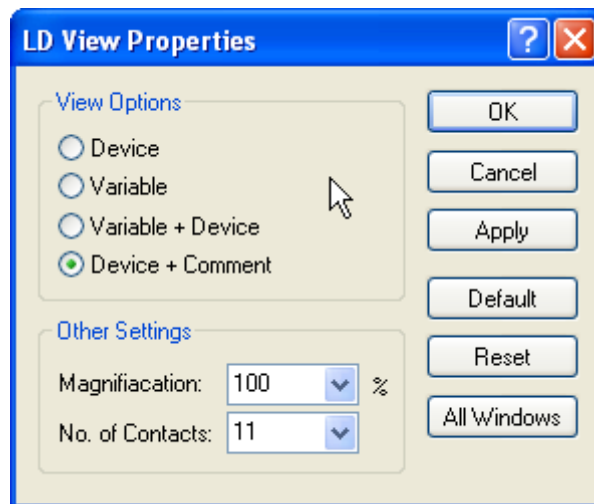

[Comment of Dialog Box]



## Chapter 5 LD Edit

- a. View Option: designates the view options for variable and device.
- b. Magnification: designates the magnification displayed in the screen. It is allowed from 40 to 200%.
- c. No. of contacts: designates the number of contact points displayed in the screen.
- d. OK: applies the settings and closes the dialog box.
- e. Cancel: closes the dialog box.
- f. Apply applies the settings to the present LD window.
- g. Default: sets the present settings as the defaults of LD window. If creating a new LD program, it is displayed in the presently set view mode.
- h. Reset: restores the present settings to the default.
- i. All Windows: applies the present settings to every screen.

### Notes

- In the LD screen properties, Device/Variable/Comment View Options can not be designated.
- In case of All Windows, the setting is applied to all of SFC program action, transition and user's function(block) created by LD.

## 5.4 Edit Function Additional

Additional functions will be described below for convenient edit.

### 5.4.1 Block Mask Instruction

This is used to specify or cancel the area Block Mask in PLC among the LD programs.

#### 1) Block Mask Instruction Setting

[Steps]

1. Move the cursor to the rung to specify the Block Mask.

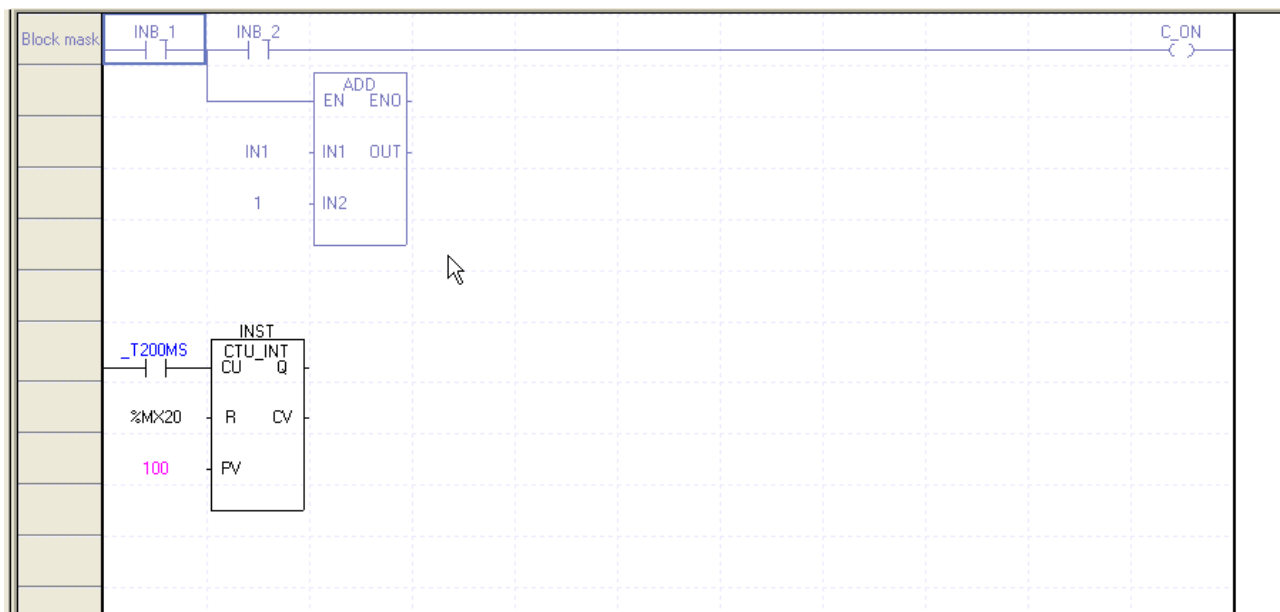

## Chapter 5 LD Edit

2. Select [Edit] - [Set Block Mask].

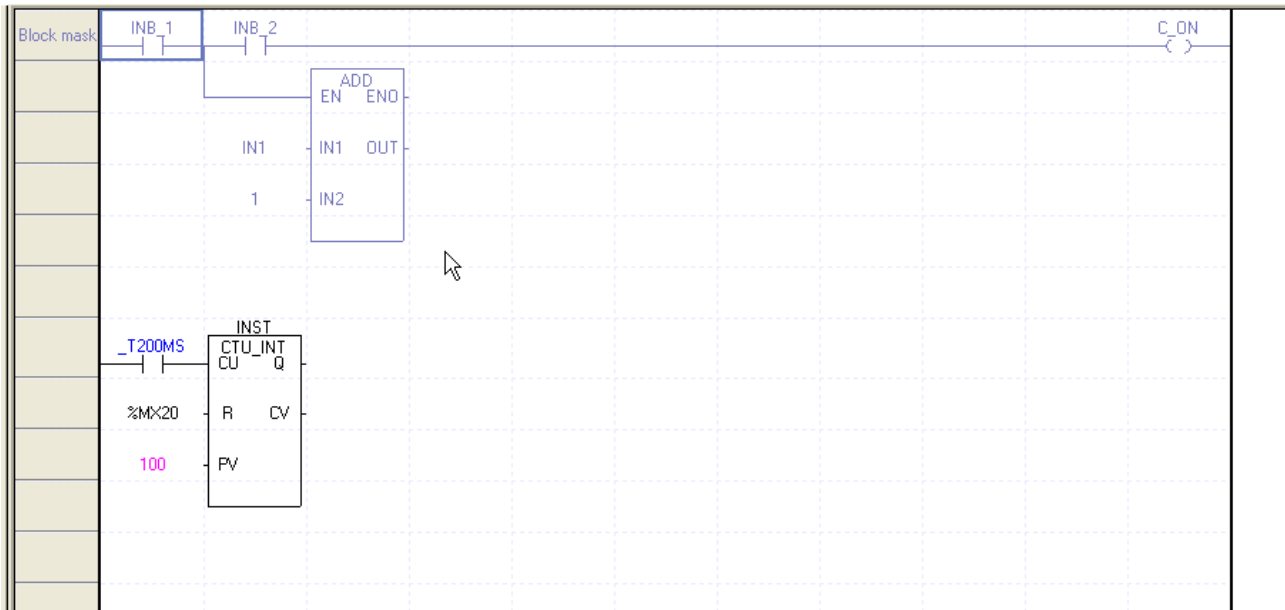

2) Block Mask Instruction Cancel

[Steps]

1. Move the cursor to the rung to cancel the Block Mask instruction.

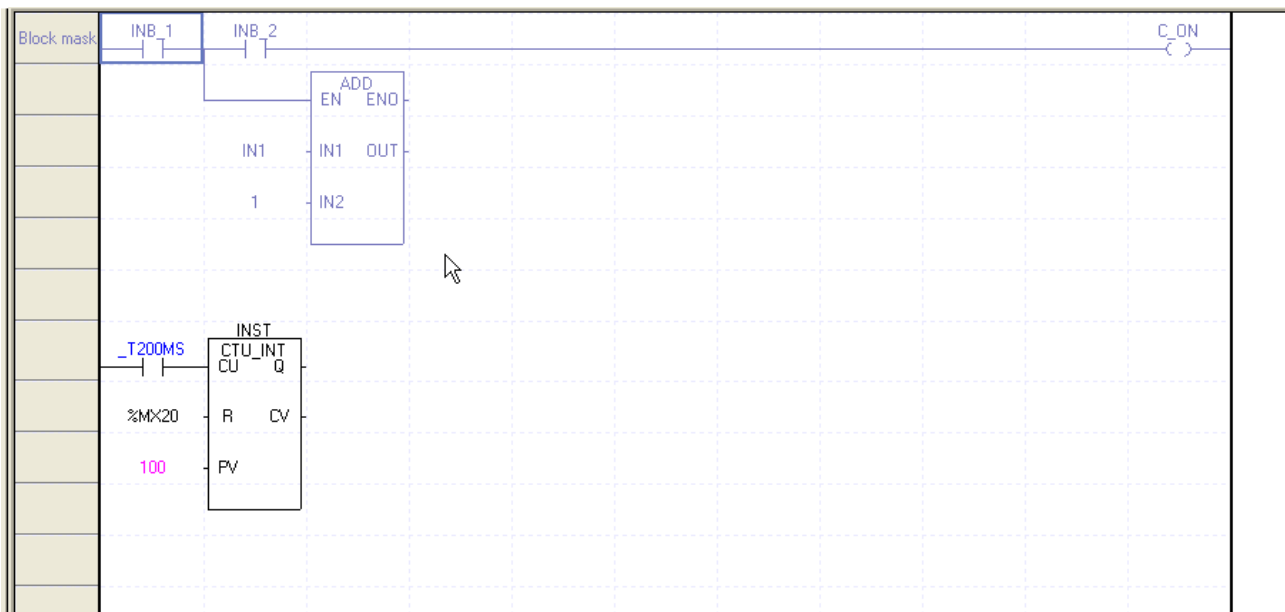

2. Select [Edit] - [Remove Block Mask] on the menu.

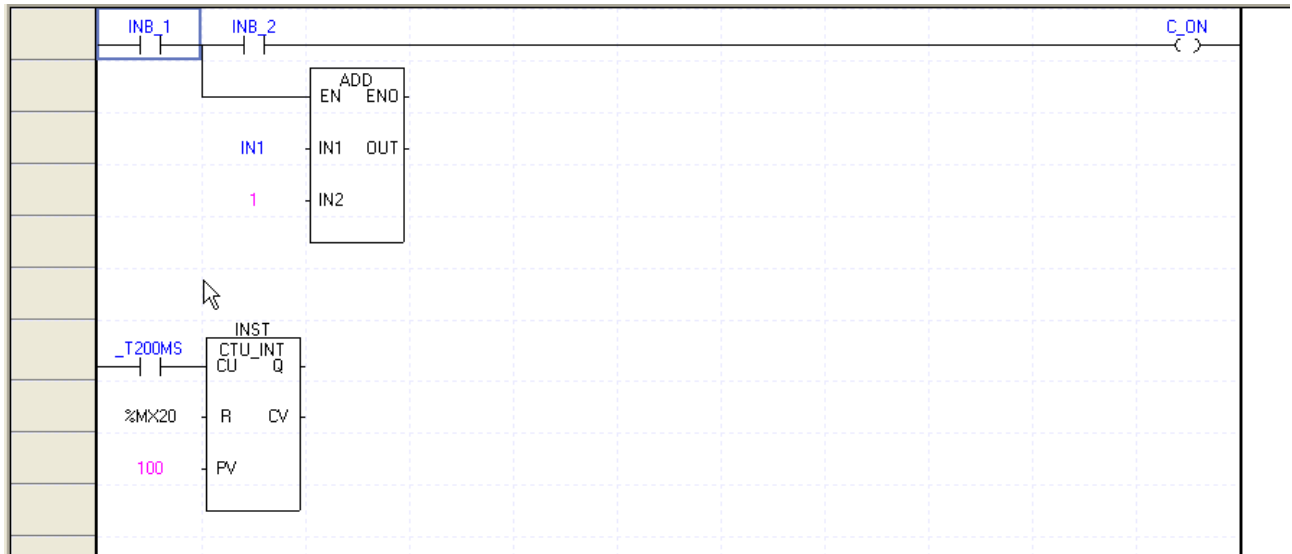

### 5.4.2 Bookmark

It allows the user easily to move to an interesting area with the bookmark specified on the line.

1) Set Bookmark

[Steps]

1. Move the cursor to the line to specify the bookmark on.

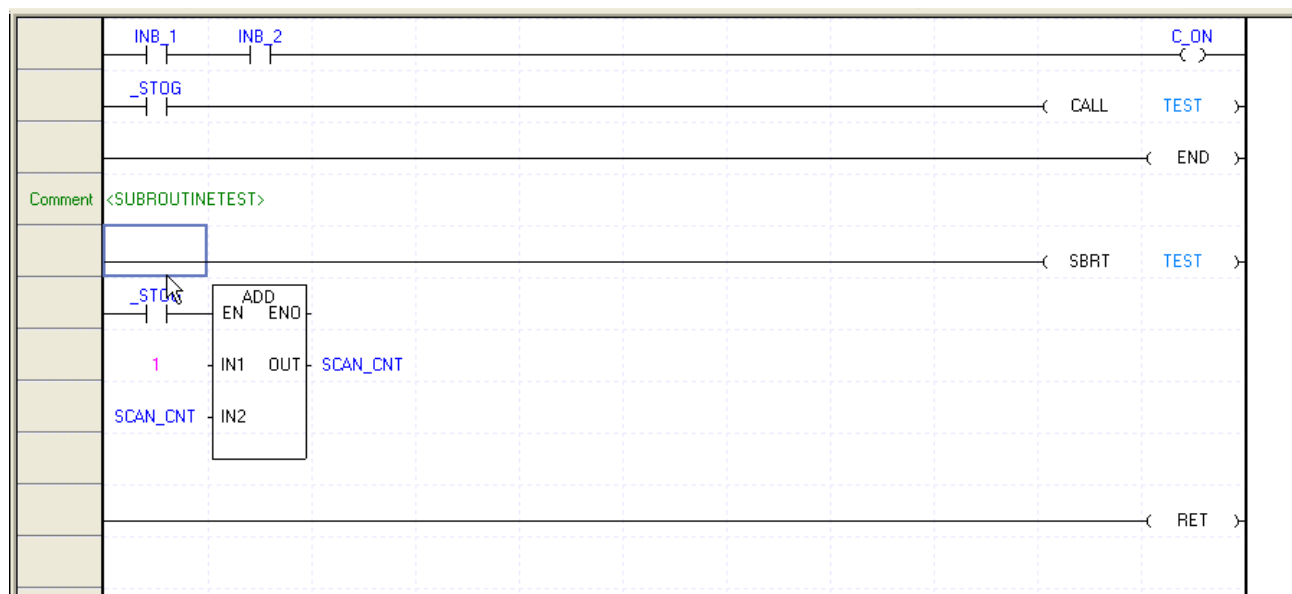

## Chapter 5 LD Edit

2. Select [Edit] - [Bookmark] - [Set/Remove] on the menu.

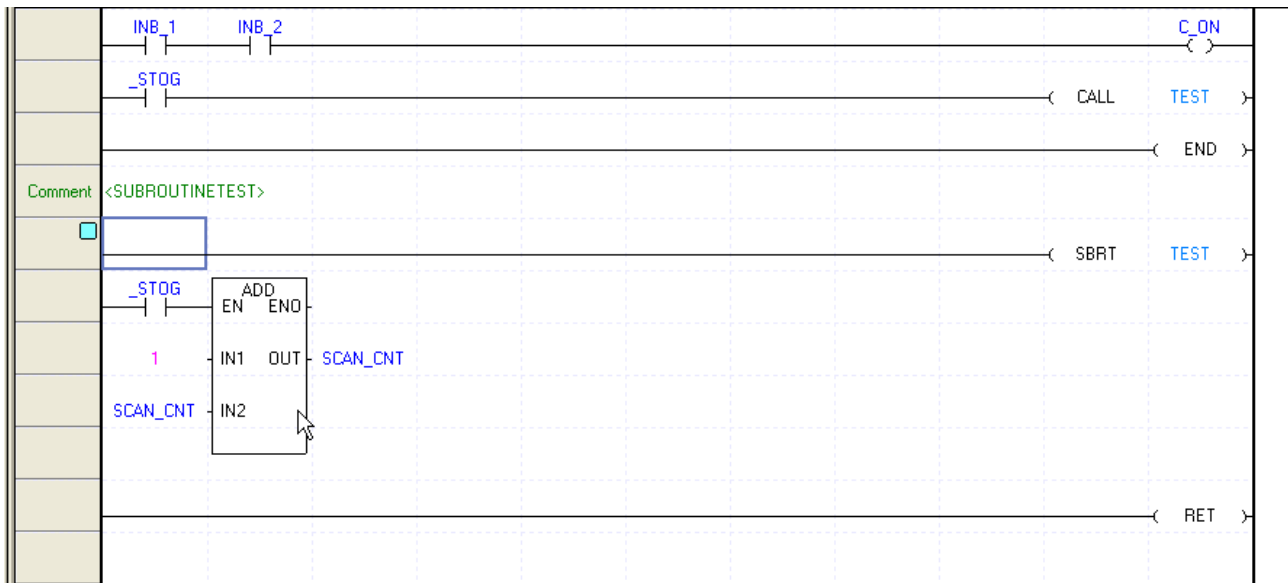

2) Bookmark Reset

[Steps]

1. Move the cursor to the line to cancel the bookmark from.

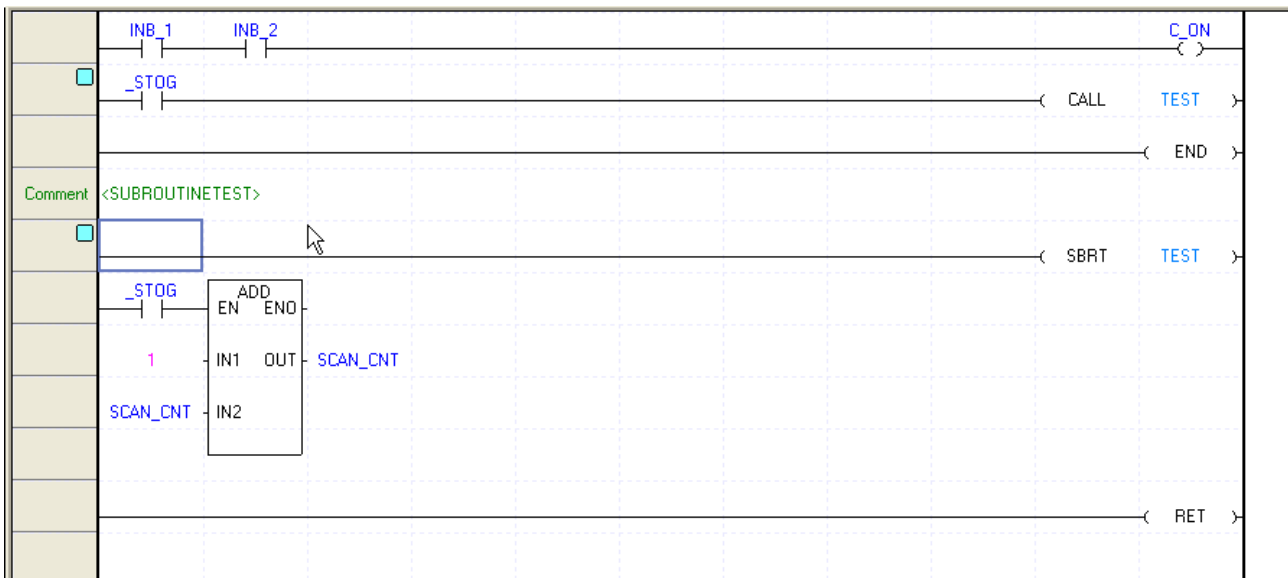

2. Select [Edit] - [Bookmark] - [Set/Reset] on the menu.

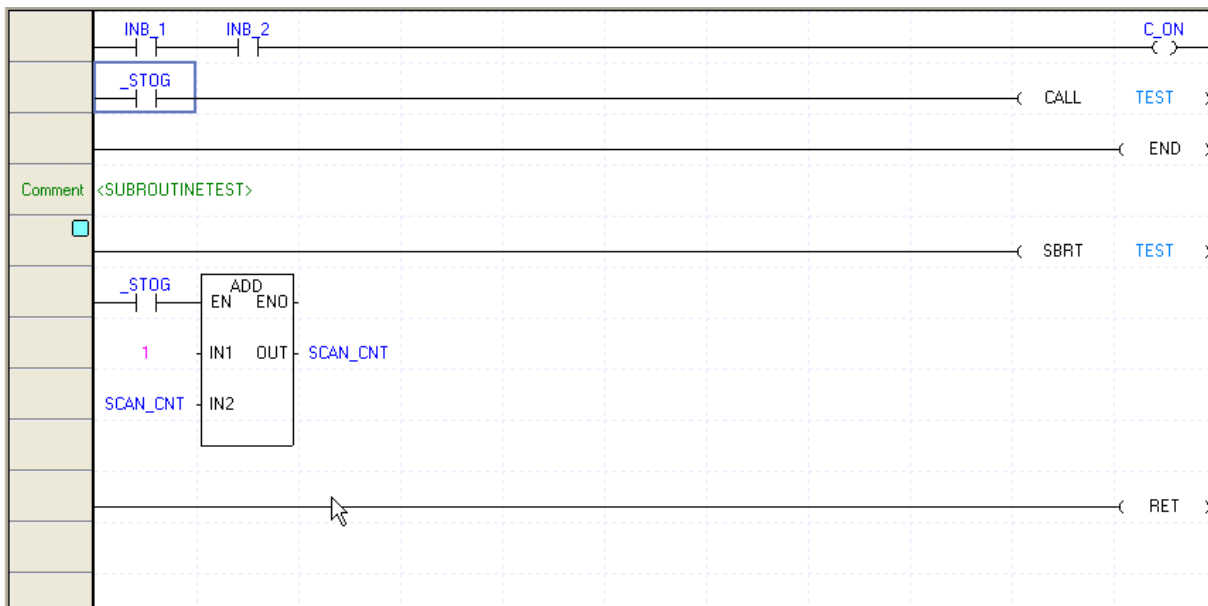

## Chapter 5 LD Edit

### 3) Reset All Bookmark

[Steps]

1. Select [Edit] - [Bookmark] - [Remove All] on the menu.

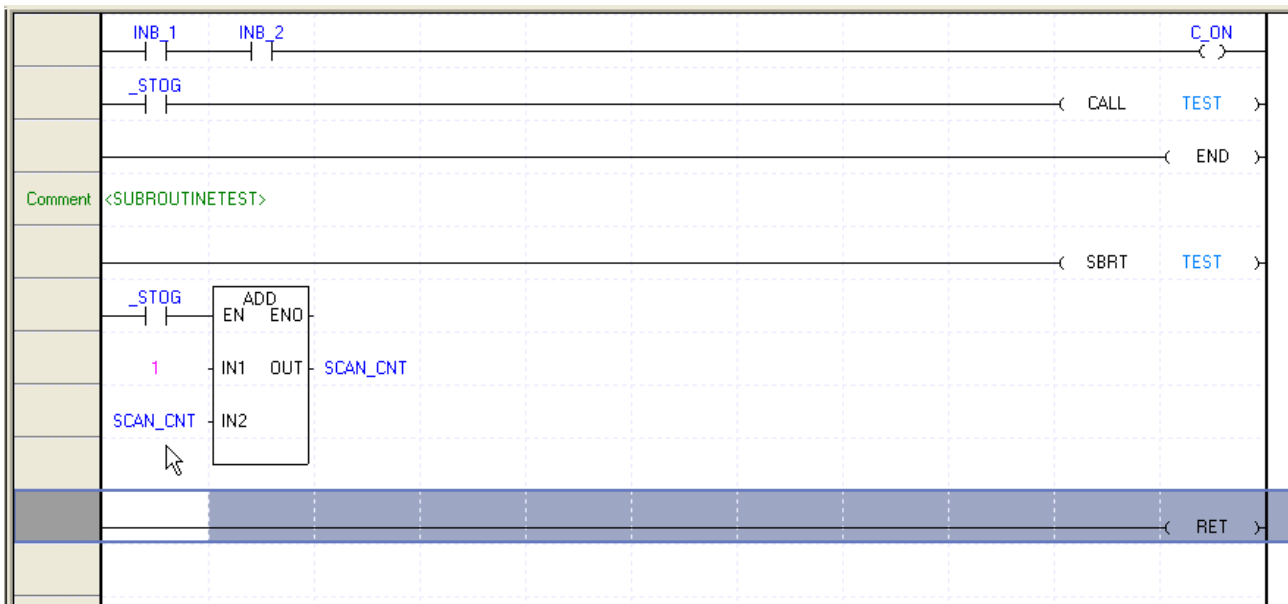
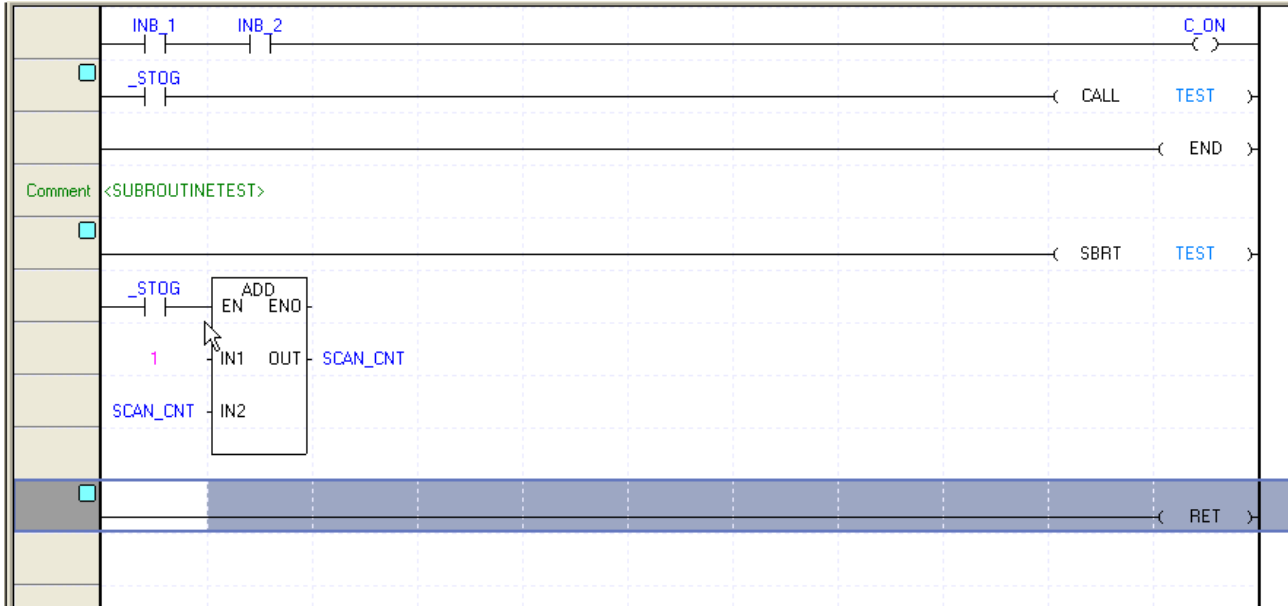

#### 4) Previous Bookmark

[Steps]

1. Select [Edit] - [Bookmark] - [Previous Bookmark] on the menu.

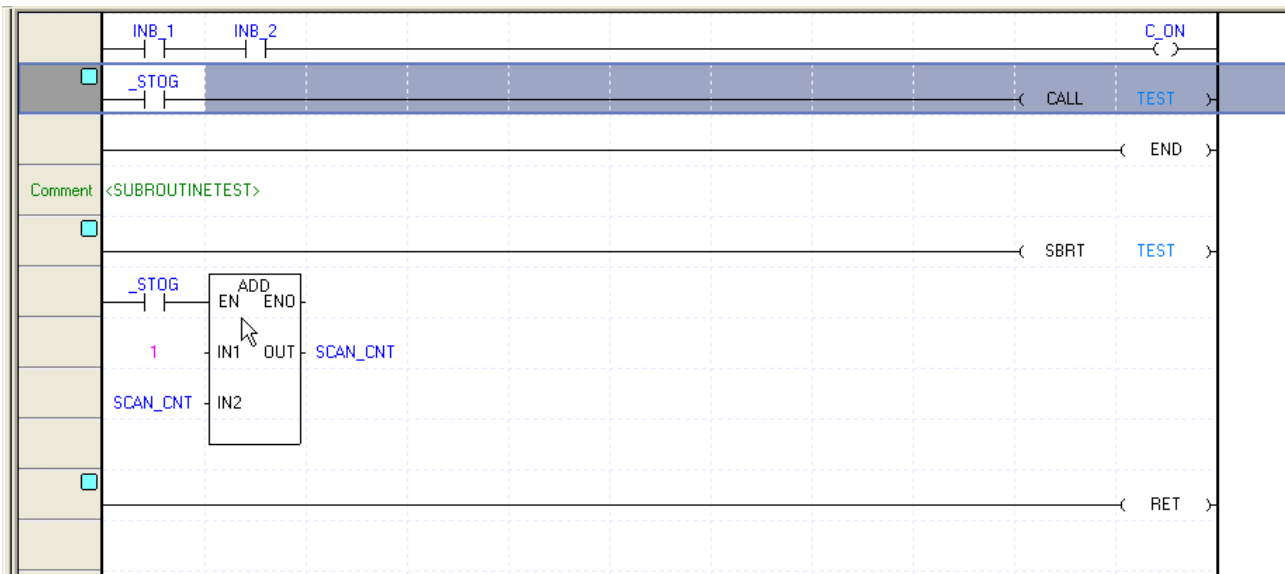
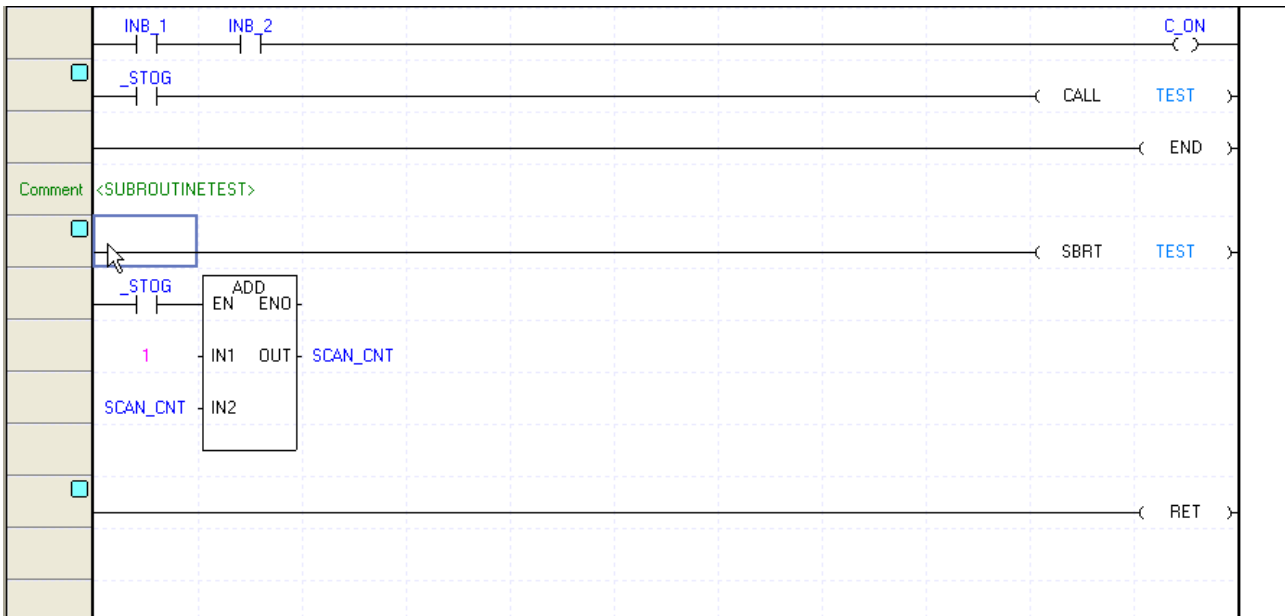



## Chapter 5 LD Edit

### 5) Next Bookmark

[Steps]

1. Select [Edit] - [Bookmark] - [Next Bookmark] on the menu.

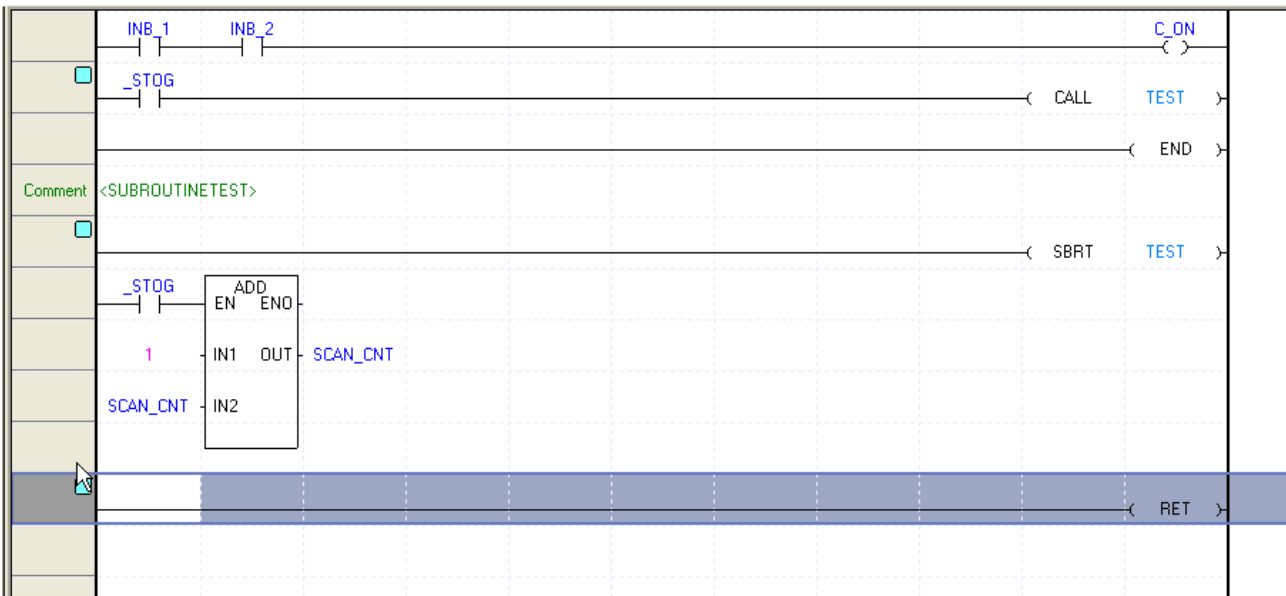
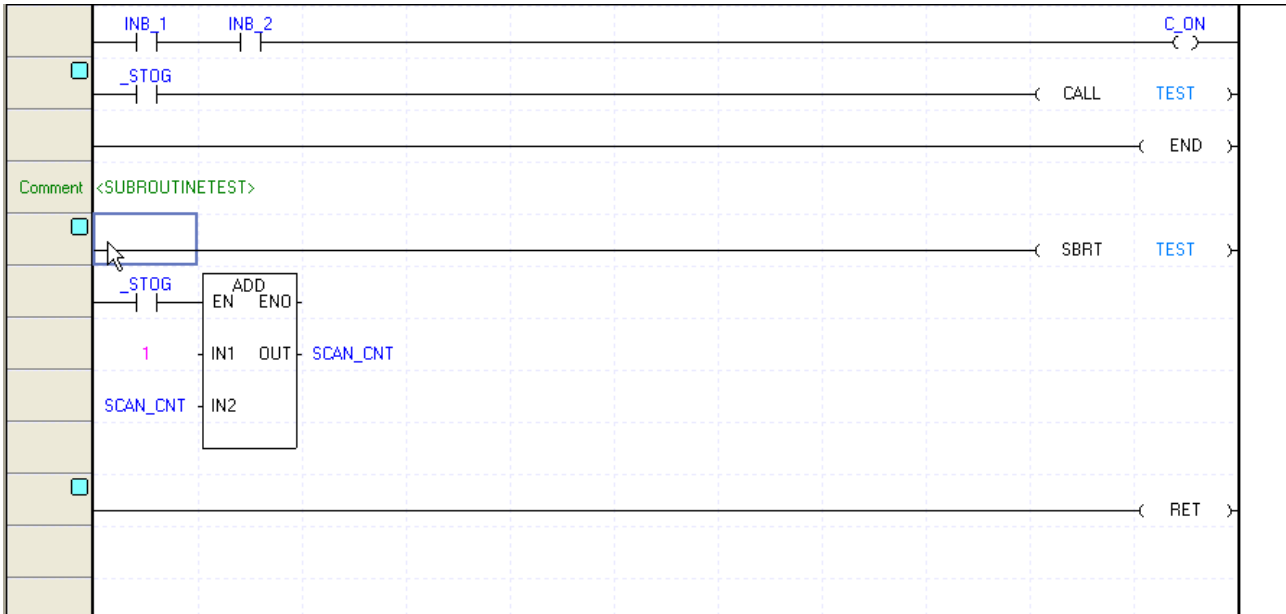

#### Notes

- Bookmark will be specified in line unit.
- Bookmark is not an item to edit, thus the Set/Reset options will not be included in Undo and Redo.

### 5.4.3 Go To

It is used to move to the specified line position, or go to the position of the edited label and rung comment.

#### 1) Go to Line

[Steps]

1. Select [Find/Replace]-[Go To]-[Step] on the menu.

[Dialog Box]

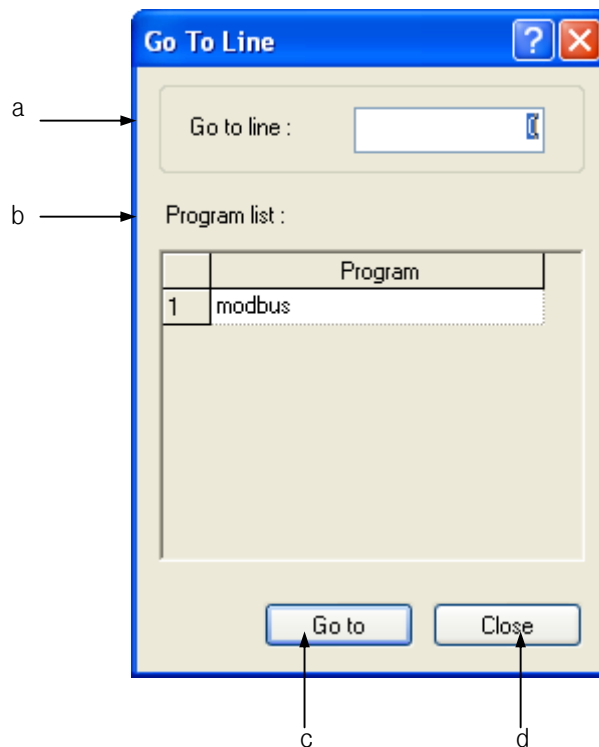

[Description of Dialog Box]

- a. Go to what: used to input the line to go to
- b. Program list: used to display the list of the present PLC programs
- c. Go to: closes the Dialog Box to go to the selected program's step to find
- d. Cancel: closes the Dialog Box.

2. Input the step to move to on the Dialog Box.

#### Notes

- It is available only in the LD program going to line.
- The LD used for SFC Action/Transition is not available in Go To.

## Chapter 5 LD Edit

### 2) Go To Label

[Steps]

1. Select [Find/Replace]-[Go To]-[Label].

[Dialog Box]

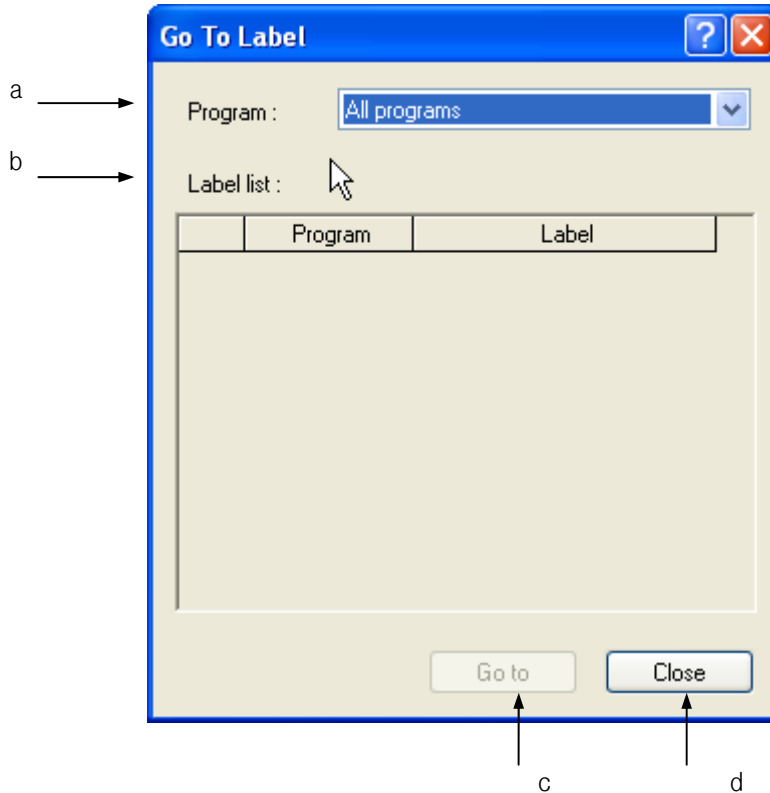

[Description of Dialog Box]

- a. Program: used to display the list of the present PLC programs. If 'All Programs' is selected, the list of all the labels will be displayed.
- b. Labels list inside the program: used to display the list of the labels used in the selected program.
- c. Go To: closes the Dialog Box to go to the selected label.
- d. Cancel: closes the Dialog Box.

2. Select the label to go to on the Dialog Box.

#### Notes

- Go To Label is available only in the LD Program.
- The LD used for SFC Action/Transition is not available in Go To Label.

## 3) Go To Rung Comment

[Steps]

1. Select [Find/Replace]-[Go To]-[Rung Comment].

[Dialog Box]

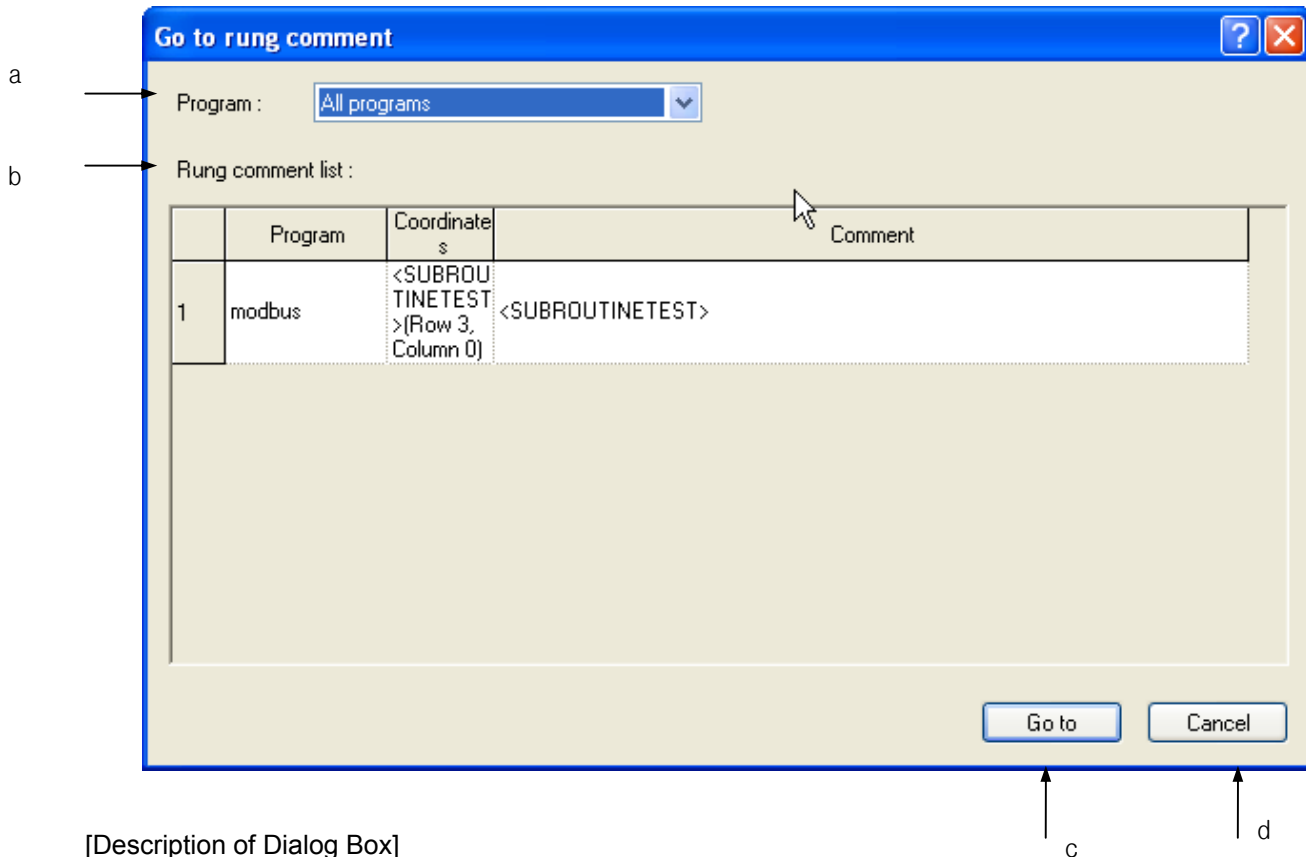

[Description of Dialog Box]

- a. Program: used to display the list of the present PLC programs. If 'All Programs' is selected, the list of all the rung comments will be displayed.
- b. Rung comment list: used to display the list of the rung comments used in the selected program.
- c. Go to: closes the Dialog Box to go to the selected rung comment.
- d. Cancel: closes the Dialog Box.

2. Select the rung comment to go to on the Dialog Box.

## Notes

- Go To Rung Comment is available only in the LD Program.
- The LD used for SFC Action/Transition is not available in Go To.

## Chapter 5 LD Edit

### 4) Go To END Instruction

[Steps]

1. Select [Find/Replace]-[Go To]-[END Instruction] on the menu.

[Dialog Box]

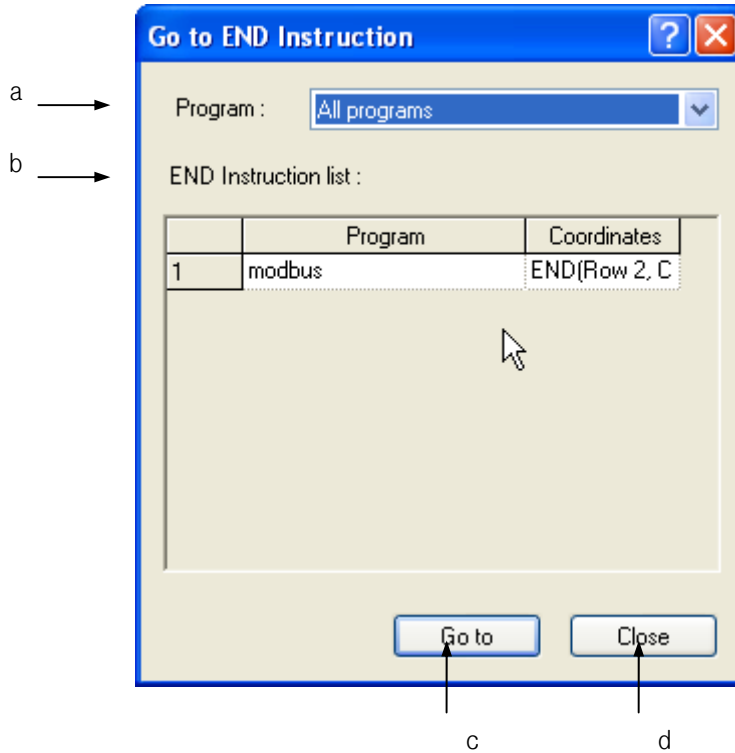

[Description of Dialog Box]

- a. Program: used to display the list of the present PLC programs. If 'All Programs' is selected, the list of all the END instructions will be displayed.
- b. END instruction list: used to display the list of the END instructions used in the selected program.
- c. Go to: closes the Dialog Box to go to the selected END instruction.
- d. Cancel: closes the Dialog Box.

2. Select the END instruction to go to on the Dialog Box.

#### Notes

- Go To END Instruction is available only in the LD Program
- The LD used for SFC Action/Transition is not available in Go To

## Chapter 6 SFC Edit

SFC is used to control the execution sequence of other program (LD, IL) by using graphic symbols (step, transition, Branch).

### 6.1 Limit

SFC program has the following limit when editing the program.

Item	Description	Limit
Max. step no.	It means available max. no. of step except step that is used as step variable in the program.	2,048
Max. row no.	Maximum row available to edit.	65,535
Max. column no.	Maximum column available to edit.	65,535

### 6.2 Program Edit

#### 6.2.1 Edit Tools

The input of SFC Edit items shall be started after the input symbols are selected from the LD tool box and the mouse clicked on the specific position or with applicable Shortcut Key pressed.

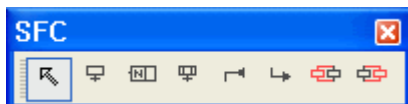

Symbol	Shortcut Key	Description
	Esc	Changes to selection mode
	-	Step+Transition or Transition+Step
	-	Action
	-	Block+Transition or transition+block
	-	Label
	-	Jump
	-	Left Branch
	-	Right Branch

## Chapter 6 SFC Edit

The following Shortcut Keys are related with the movement of the cursor. Applicable Shortcut Keys can not be specified by users in the XG5000.

Shortcut Key	Description
Home	Moves to the start of the column.
Ctrl + Home	Moves to the start of the program
→	Deletes the present data and moves to the left.
←	Moves the present cursor to the right by a blank.
↑	Moves the present cursor to the left by a blank.
↓	Moves the present cursor upward by a blank.
End	Moves the present cursor downward by a blank.
Ctrl + End	Moves to the end of the column.

### Notes

- Among Shortcut Keys in Edit Toolbox, 's' stands for Shift key, 'c' for Ctrl key, 'a' for Alt key..
- The Shortcut Keys described in Edit Tool are based on the Shortcut Keys basically provided in XG5000. For more details on the user defined Shortcut Keys, Refer to 2.4 Shortcut Key Setting in Chapter 2 Basic Application.

### 6.2.2 Input step/transition

This is used to input Step/Transition.

[Steps]

1. Move the cursor to the location you want edit.
2. Select symbol on the tool box and click the edit area. Or press shortcut key applicable to symbol.

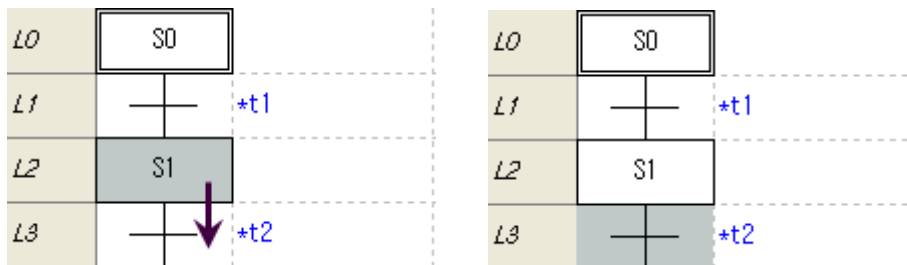

3. New Step/Transition is inputted.

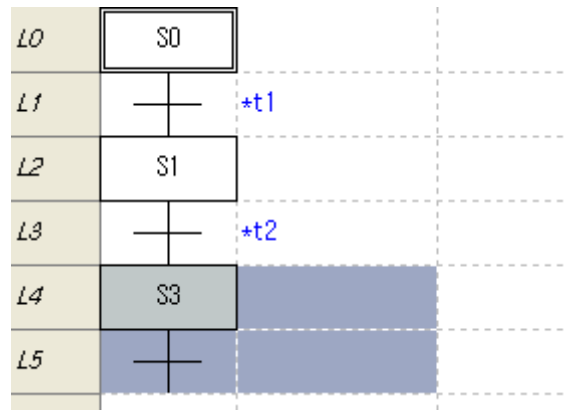

**Notes**

- Step name is allocated automatically. You can change it if you want.
- According to input location, Step + Transition or Transition + Step is inputted.

	Item of location selected
Step + Transition	Transition, start line of parallel branch, label, selection branch termination line
Transition + Step	Step, Block, start line of selection branch, parallel branch termination line

**6.2.3 Input Action**

Action is executed when step is activated. Executes the program connected with action.

[Steps]

1. Move the cursor to the location you want edit

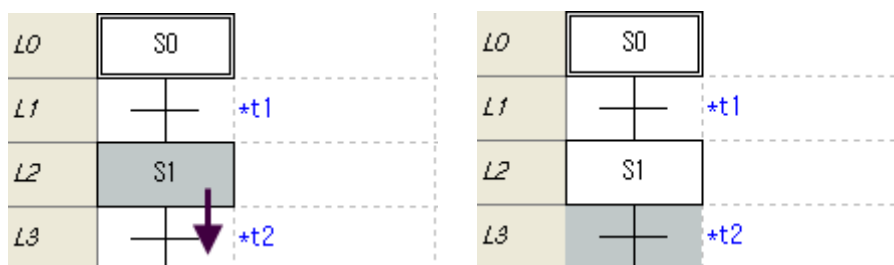

or



## Chapter 6 SFC Edit

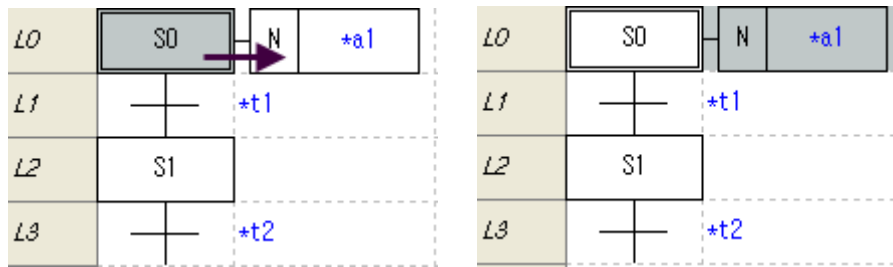

2. Select symbol on the tool box and click the edit area. Or press shortcut key applicable to symbol.

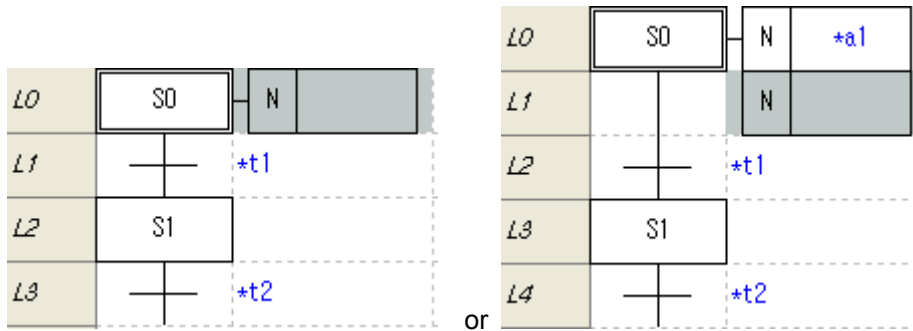

### Notes

- Action's location is different according to selected edit area.

Location	item
Right	Action's location is the right of step when selecting step
Bottom	Action's location is the bottom of action when selecting action

- The no. of step connected with one step is not limited.

- Action can not be connected with block.

### 6.2.4 Input Block/Transition

Inputs Block/Transition.

[Steps]

1. Move the cursor to the location you want edit.

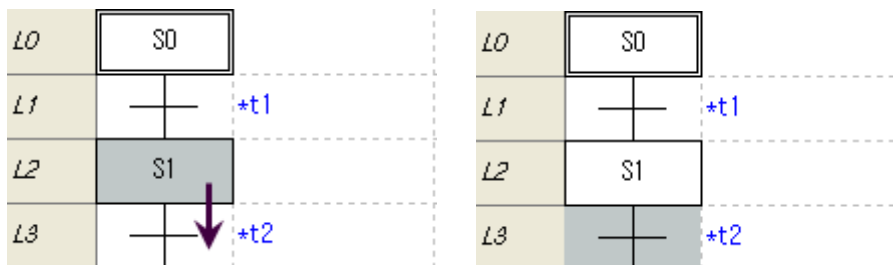

2. Select block on the tool box and click the edit area or click the shortcut key applicable to symbol.
3. New block/Transition is inputted.

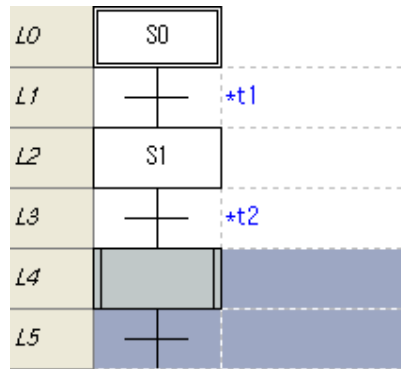

**Notes**

- Block input location standard is same with step input.

**6.2.5 Input label**

Inputs label.

[Steps]

1. Move the cursor to the location you want edit.

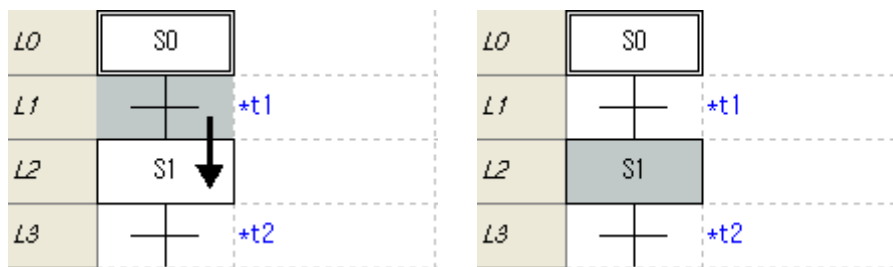

2. On the tool box, select the label to input and then click the edit area. Or click the Shortcut Key applicable to symbol.
3. New label is inputted.

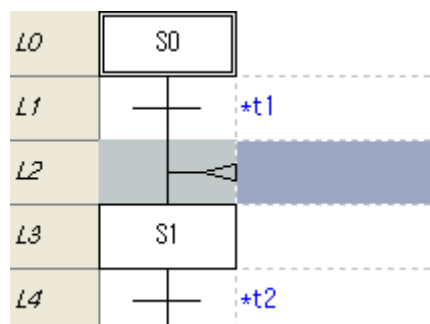

## Notes

- Label can be inputted when selecting step or block.
- Label is inputted ahead of the selected step or block.

### 6.2.6 Input Jump

Inputs Jump.

[Steps]

1. Move the cursor to the location you want edit

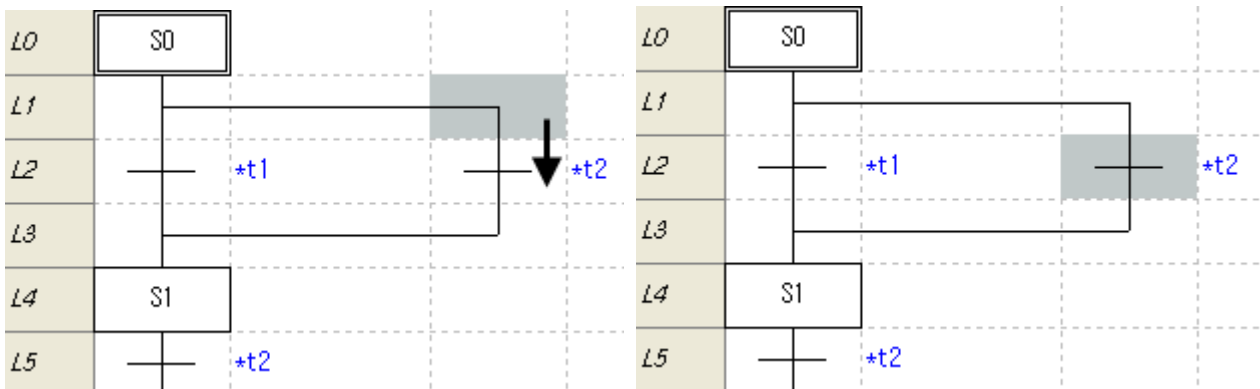

2. On the tool box, select the Jump to input and then click the edit area. Or click the Shortcut Key applicable to symbol.
3. New jump is inputted.

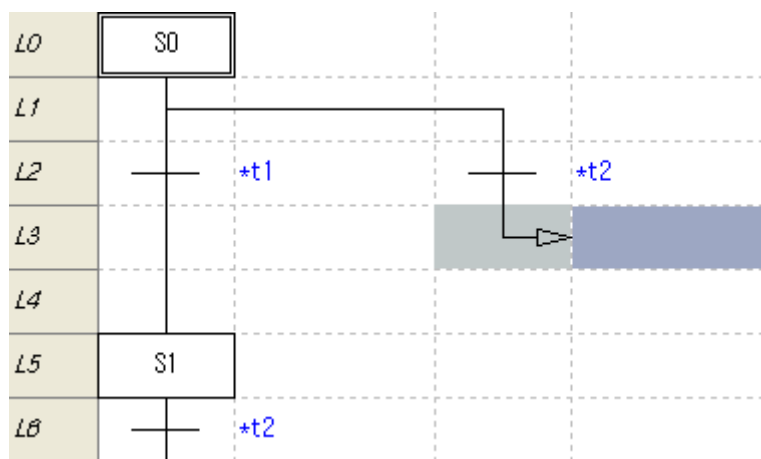

**Notes**

- The jump can be inputted when selecting last transition within selection branch or transition of program in the last row.
- The jump is inputted ahead of the selected transition.
- The Jump is available within same program.

### 6.2.7 Input left branch

Input left branch. Example is the selection branch.

1) Make branch

[Steps]

1. Move the cursor to the location to start branch.

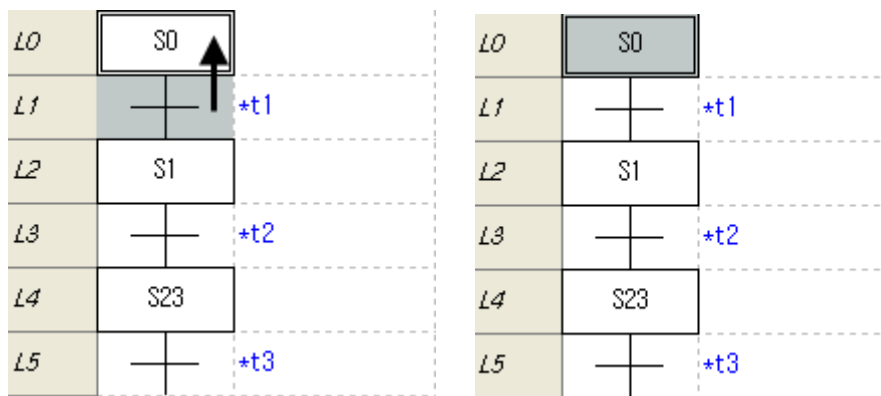

2. On the tool box, select left branch and click the edit area or press shortcut key.

3. It displays branch start location and branch connection location.

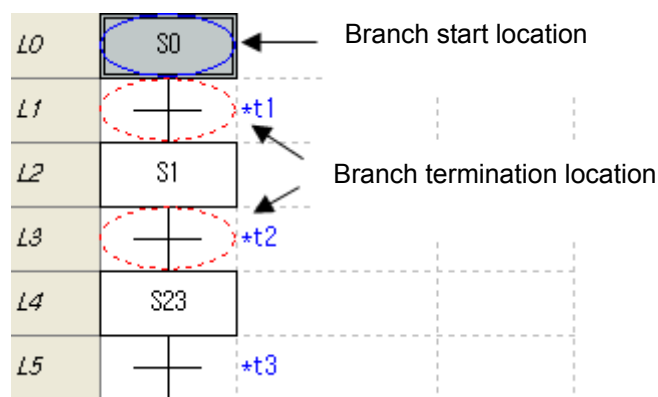

## Chapter 6 SFC Edit

4. Move cursor to the branch termination location.

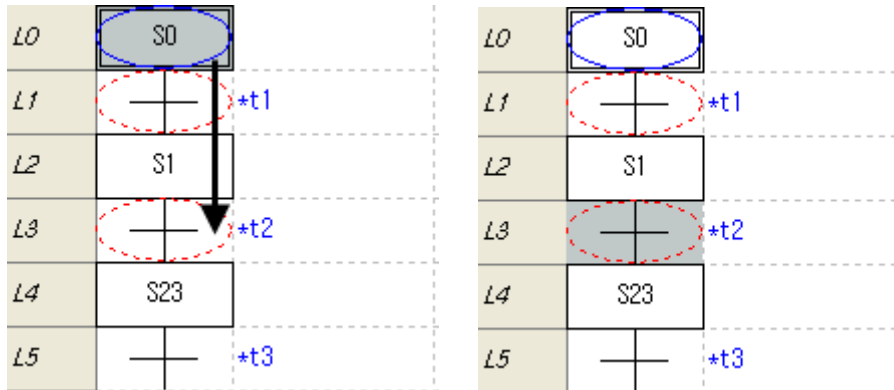

5. Select the branch termination location.

6. The branch is made.

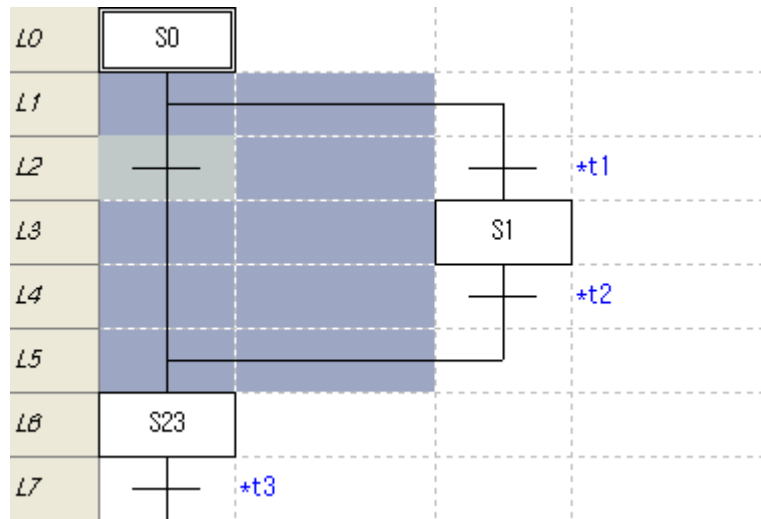

### Notes

- When selecting the branch start location, the selection branch or parallel branch is made according to branch start location.

	Item of branch start location	Line shape
Selection branch	Step, block	Horizontal one line
Parallel branch	Transition	Horizontal two line

2) Increase branch

[Steps]

1. Move the cursor to the branch to increase.

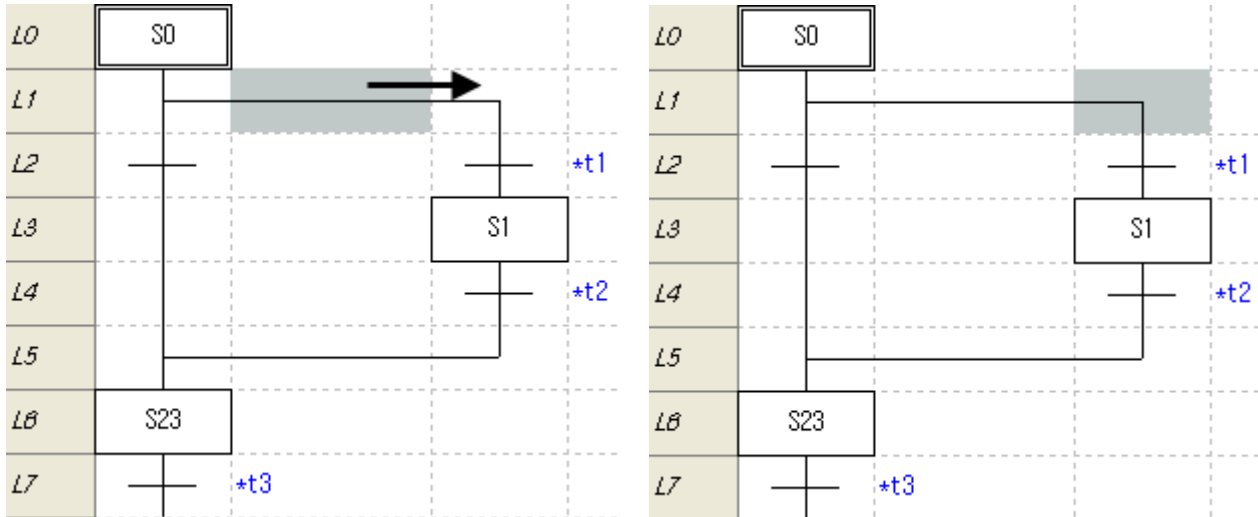

2. On the tool box, select the left branch and click the edit area or press shortcut key.

3. New branch is inputted.

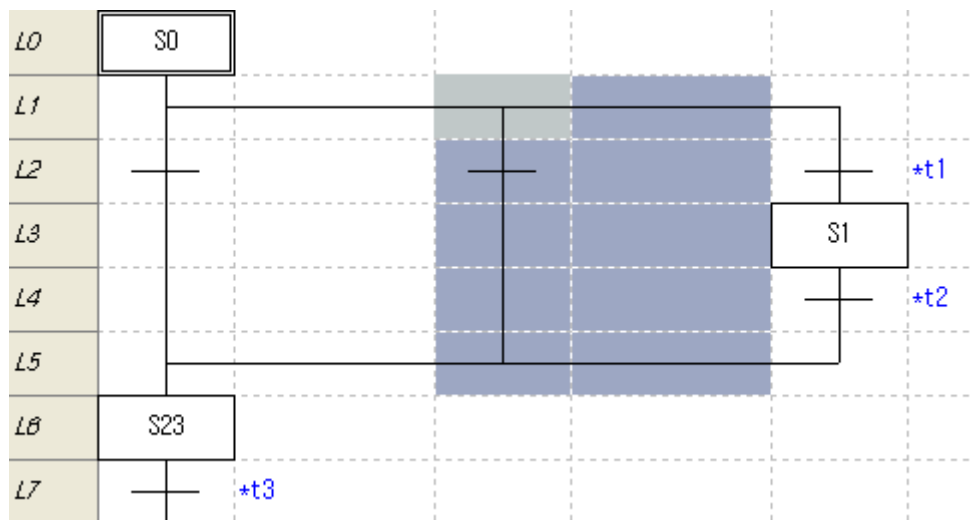

Notes

- Branch's increase no. is not limited but because of horizontal row limit, you may not increase it more than row limit
- The selection branch is not increased as parallel branch or parallel branch is not increased as the selection branch.

### 6.2.8 Input right branch

Input right branch. Example is parallel branch.

1) Make branch

[Steps]

1. Move the cursor to the location to start the branch.

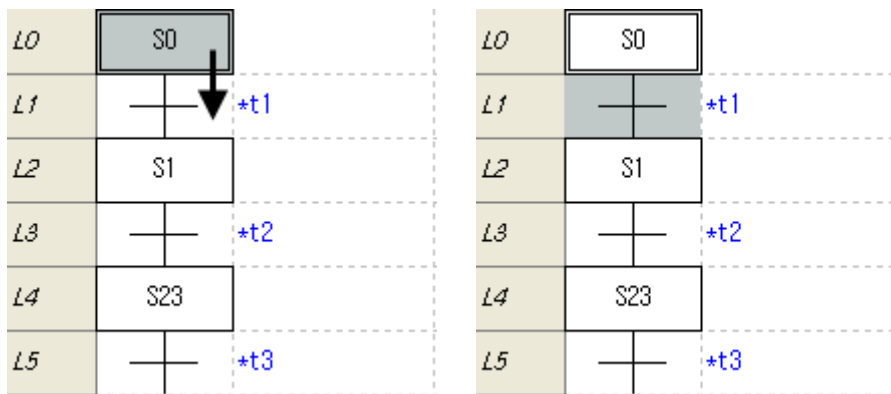

2. On the tool box, select the right branch and click the edit area. Or press shortcut key.

3. It displays the branch start location and the branch connection location.

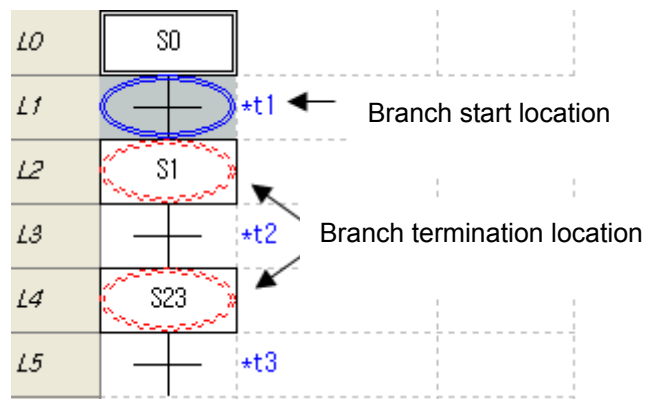

4. Move the cursor to the branch termination location.

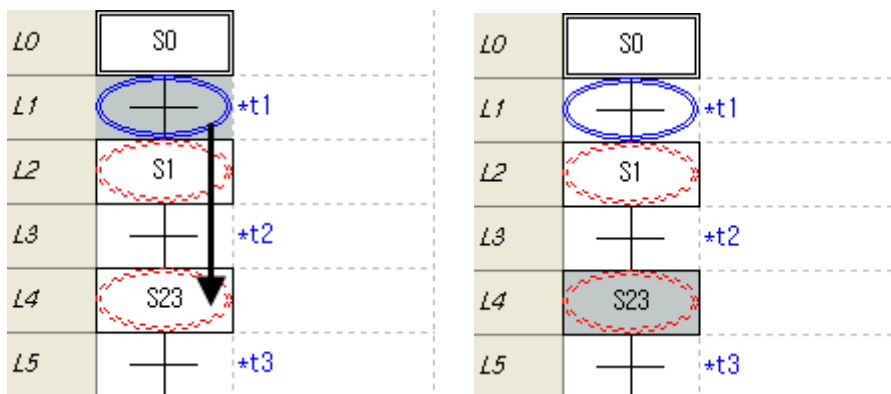

5. Select the branch termination location.
6. The branch is made.

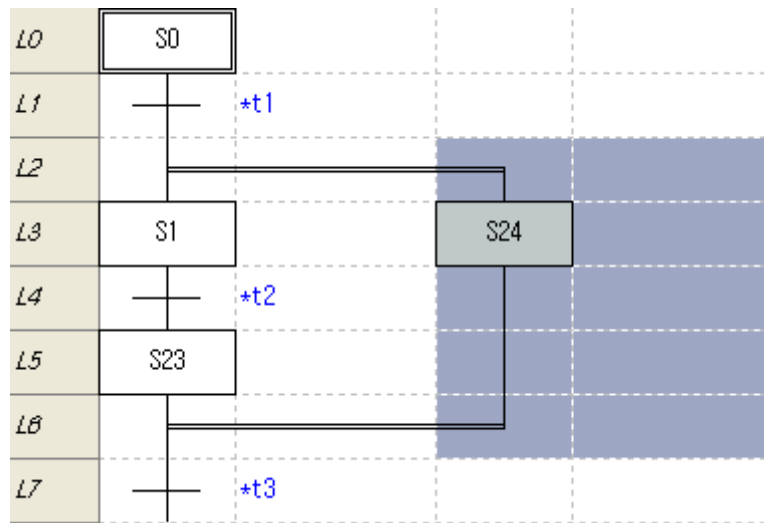

**Notes**

- The principle to make the selection or parallel branch is same with left branch. So refer to the 6 2.7 'input left branch'

2) Increase branch

[Steps]

1. Move the cursor to the location to increase the branch.

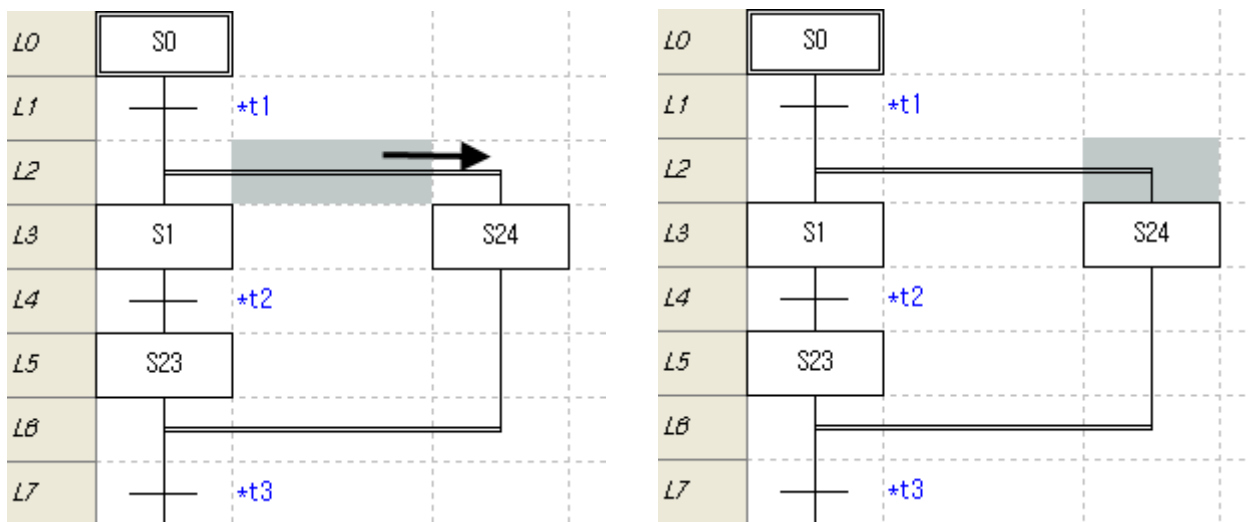



## Chapter 6 SFC Edit

2. On the tool box, select the right branch and click the edit area. Or press shortcut key.
3. New branch is inputted.

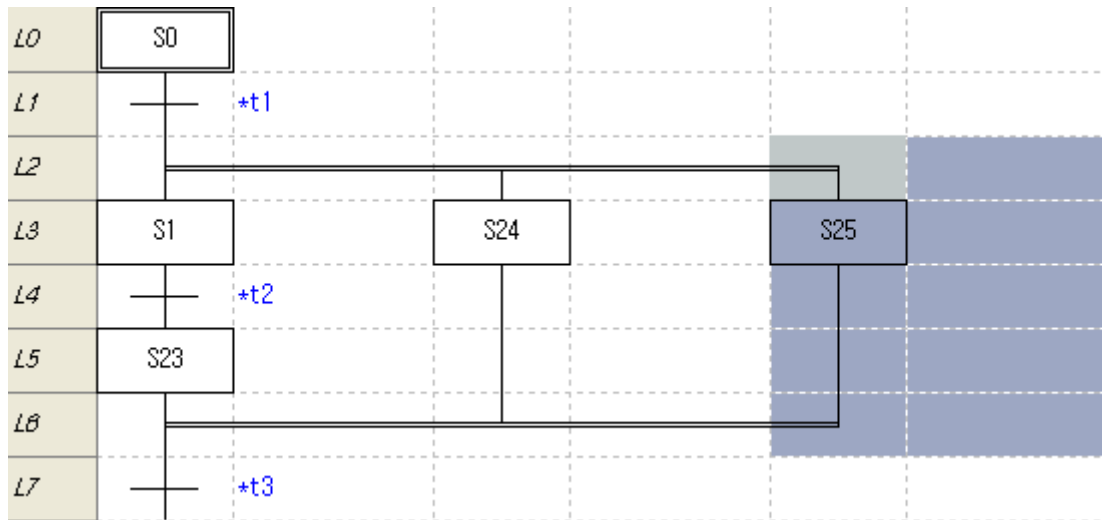

### 6.2.9 Edit Step Property

Edit step name, comment and etc.

[Steps]

1. Move the cursor to the location you want to edit.

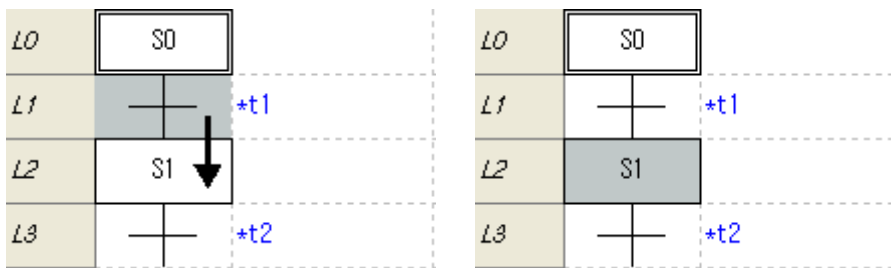

2. Press Enter key or double-click the left button of mouse.

[Dialog box]

The dialog box is titled "Step Properties" and has a blue header with a question mark and a close button. It contains the following fields and controls:

- Name: A text box containing "S0" with a mouse cursor over it.
- Comment: A text area with a scroll bar.
- Initial step: A checked checkbox.
- Step variable: An unchecked checkbox.
- Buttons: OK, Cancel, and Find.

[Dialog description]

- Name: inputs step name.
- Comment: inputs step comment.
- Initial step: designates it as initial step.
- Step variable: refers to step name from local variable list.
- Find: you can designate variable in the local variable list.
- OK: save the contents and close window
- Cancel: closes window.

#### Notes

- The initial step is execution start step of program. You can designate only one. When checking the program, it checks the error.
- When using step variable, you can refer it from other program.

### 6.2.10 Transition property

Edit the transition's name, comment.

[Steps]

- Move the cursor to the location you want edit.

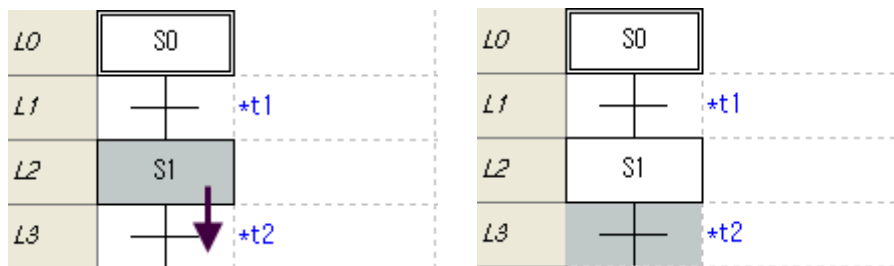

- Press Enter key or double-click the mouse left button.

[Dialog box]

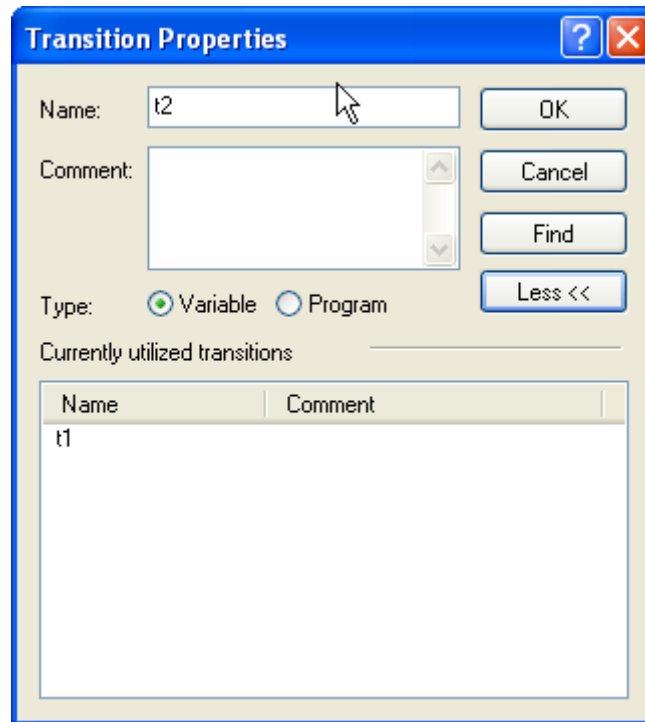

[Dialog box description]

- Name: input transition's name.
- Comment: input transition's comment.
- Type: You can designate transition as variable or program.
- List: displays the other transition used in the current program.
- Find: You can designate variable from local variable list.
- Less: hides the list.
- OK: saves the contents and close window.
- Cancel: closes window.

### Notes

- Transition program can be written by LD program.

### 6.2.11 Action property

Edit the action's name, comment, and qualifier.

[Steps]

1. Move the cursor to the location you want edit.

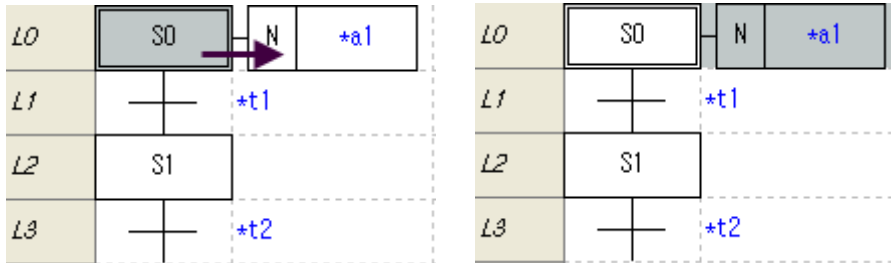

2. Press Enter key or double-click the mouse left button.

[Dialog box]

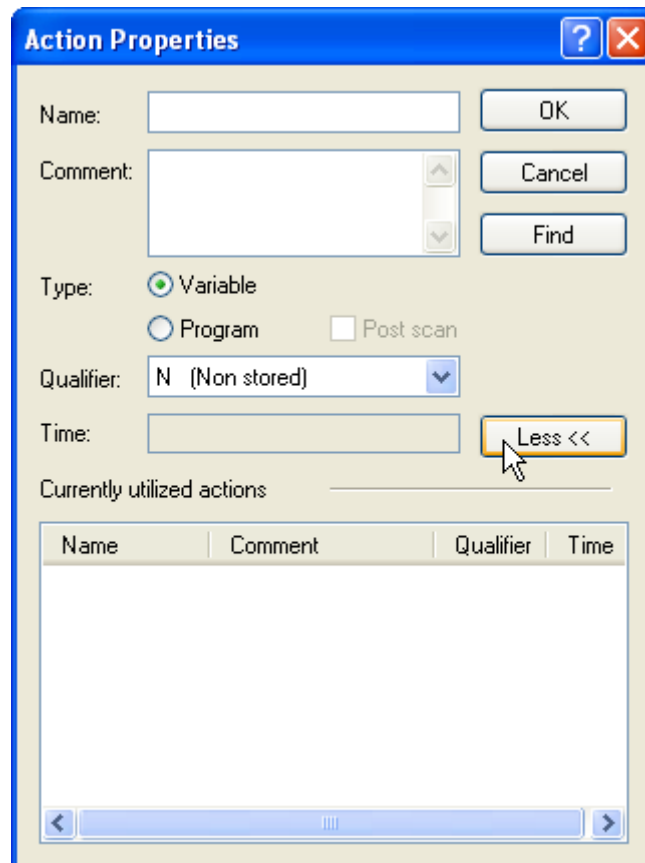

## Chapter 6 SFC Edit

---

[Dialog box description]

- a. Name: inputs action's name.
  - b. Comment: inputs action's comment.
  - c. Type: it can designate action as variable or program.
  - d. Post scan: after executing the action, deactivates the coil in the action.
  - e. List: displays the other actions used in the current program.
  - f. Qualifier: It can act differently according to action qualifier.
  - g. Time: inputs time according to qualifier.
  - h. Find: You can designate variable from local variable list.
  - i. Less: hides the list.
  - j. OK: saves the contents and close window.
- Cancel: close window.

Notes

- Action can operate differently according to action qualifier..

Qualifier.	Functions	Action characteristic
N (Non-stored)	Action is executed when step is activated.	
R (overriding Reset)	When step is activated, the action whose qualifier is S, SD, DS, SL stops.	
S (Set)	If step is activated, it continues its execution unit R qualifier is executed.	
L (time Limited)	If step is activated, it continues its execution during setting time.	
D (time Delayed)	If step is activated, action starts after setting time.	
P (Pulse)	If step is activated, it continues its execution during one scan.	
SD (Stored & time Delay)	If step is activated, action starts after setting time and it continues its execution unit R qualifier is executed. If R qualifier is executed before setting time, action is not executed.	
DS (time Delayed & Stored)	If step is activated, action starts after setting time and it continues its execution unit R qualifier is executed. If R qualifier is executed before setting time or step is deactivated, action is not executed.	
SL (Stored & time Limited)	It continues its execution during setting time or unit R qualifier is executed.	

- You can input time expression such as "T#1h2m3s" "T#2m" "T#15s".

- Action program can be written by LD or SFC.

### 6.2.12 Edit Block Property

Edit block's name, comment and etc.

[Step]

1. Move the cursor to the location you want to edit.

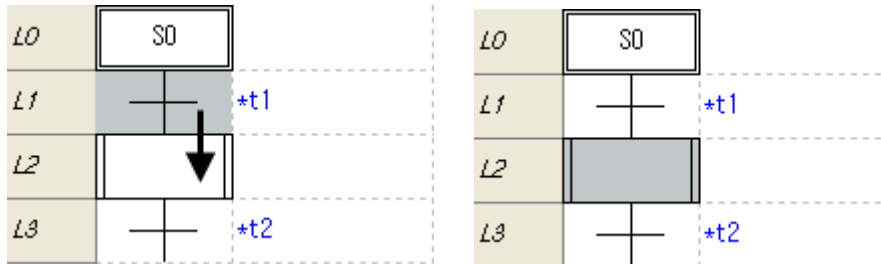

2. Press Enter key or double-click the left mouse button.

[Dialog box]

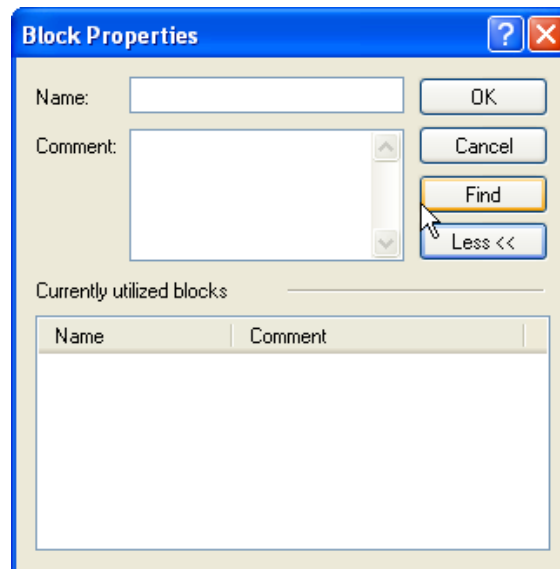

[Dialog box description]

- a. Name: inputs block's name.
- b. Comment: inputs block's comment.
- c. List: displays other block used in the current program.
- d. Less: hides list.
- e. OK: saves the contents and close window
- f. Cancel: closes window.

#### Notes

- Block can be written by only SFC program.
- Action can not be connected with block.

### 6.2.13 Edit label property

Edit label's name.

[Steps]

1. Move the cursor to the location you want to edit.

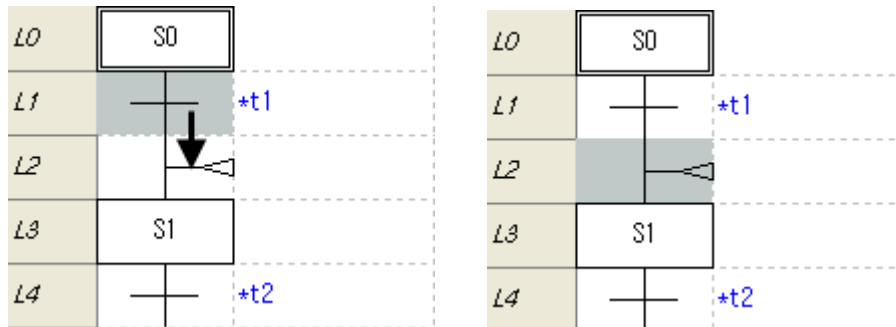

2. Press Enter key or double-click the left mouse button.

[Dialog box]

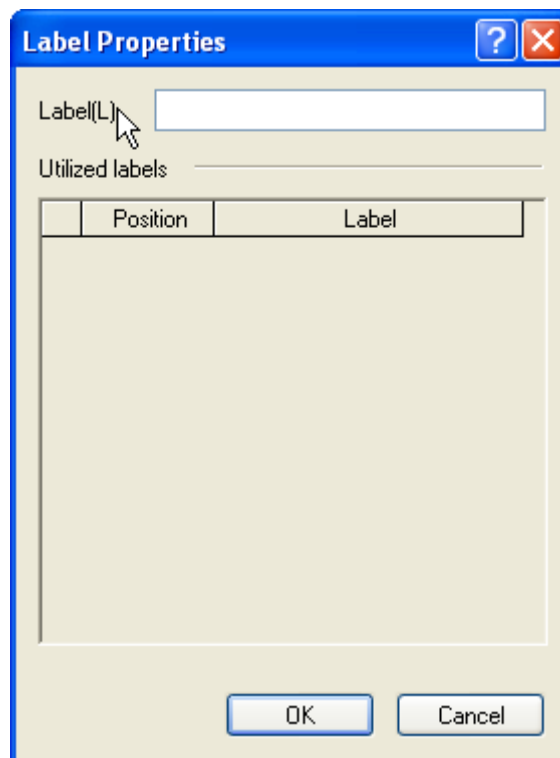



[Dialog box description]

- Label: inputs label's name.
- List: displays other label used in the current program.
- OK: saves the contents and close window.
- Cancel: closes the dialog box.

### 6.2.14 Jump property

Edit jump's name.

[Steps]

1. Move the cursor to the location you want to edit.

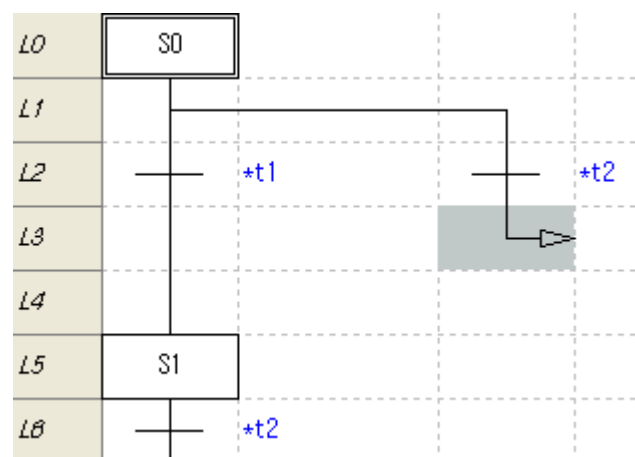
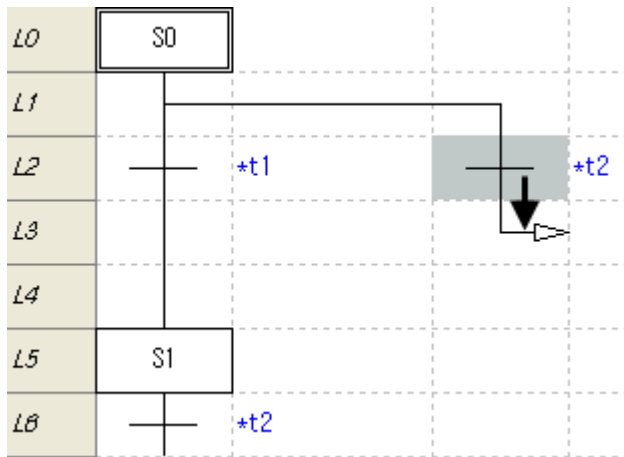

2. Press Enter key or double-click the left mouse button..

[Dialog box]

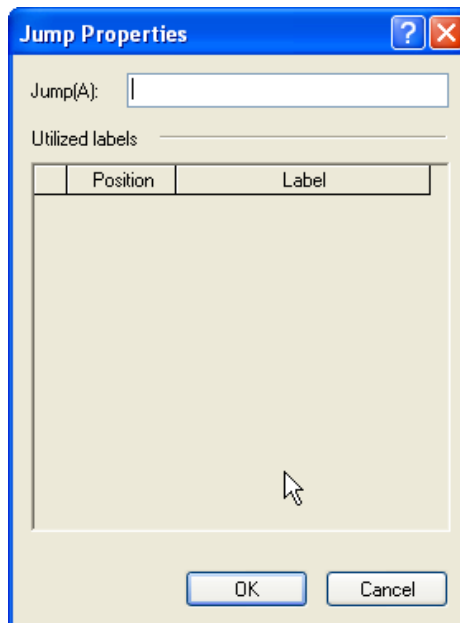

[Dialog description]

- Jump: inputs jump's name.
- List: displays other label used in the current program.
- OK: saves the contents and close window.
- Cancel: closes the dialog box.

#### Notes

- Jump name should be same with label name.
- Jump to other SFC program is not available.

### 6.2.15 Set Branch Priority

You can set branch priority.

[Steps]

1. Move the cursor to the select branch's start location.

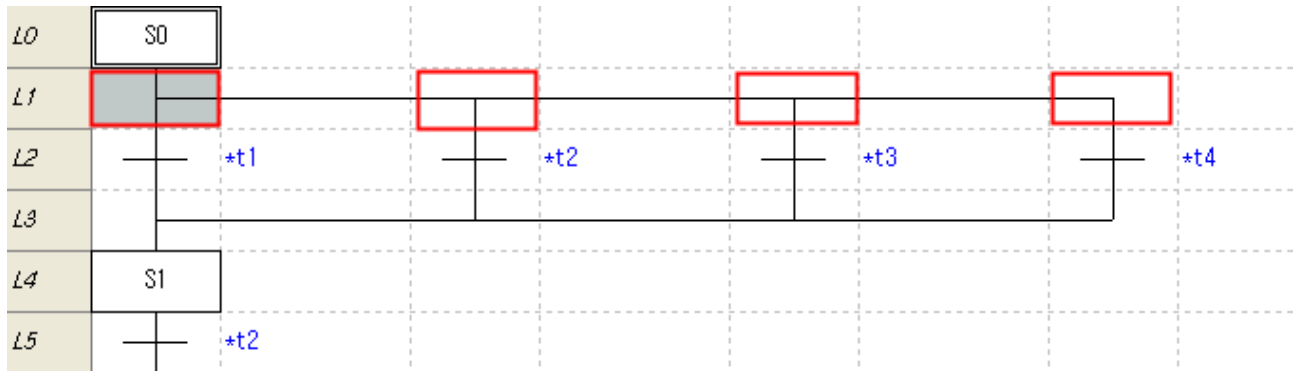

2. Select [Edit] – [Set Branch Priority] on the menu
3. Click the select branch's start location in order and set branch priority.

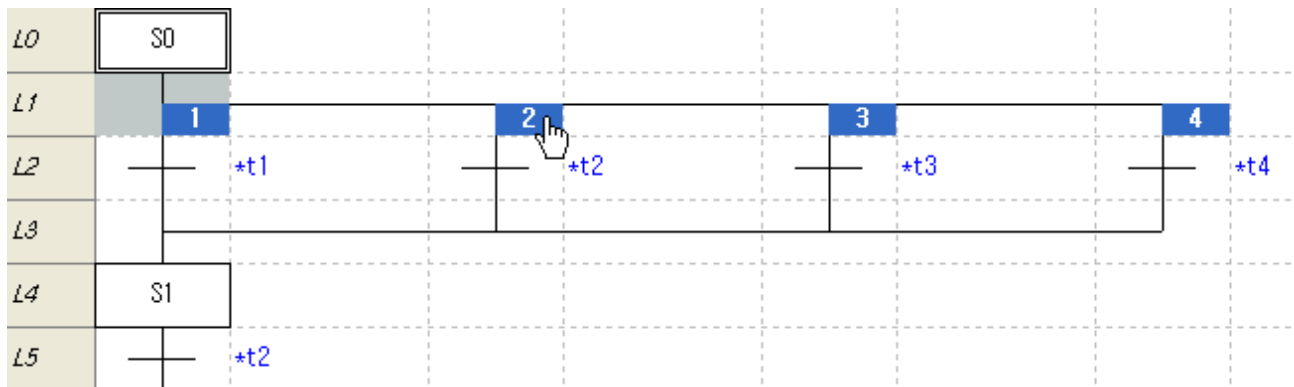

4. If you click other area except selection branch start location, the editing is over.

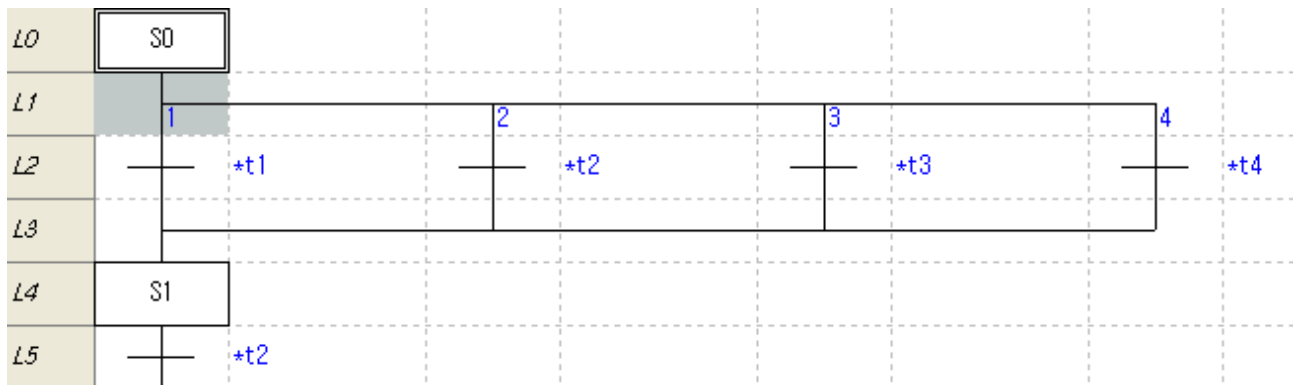

## Notes

- You can set selection branch priority as many as branch number.
- When not setting branch priority, compile is done from left to right. Program is executed from left to right.

## 6.2.16 Erase Branch Priority

Erase branch priority.

[Steps]

1. Move the cursor to the branch that has priority.

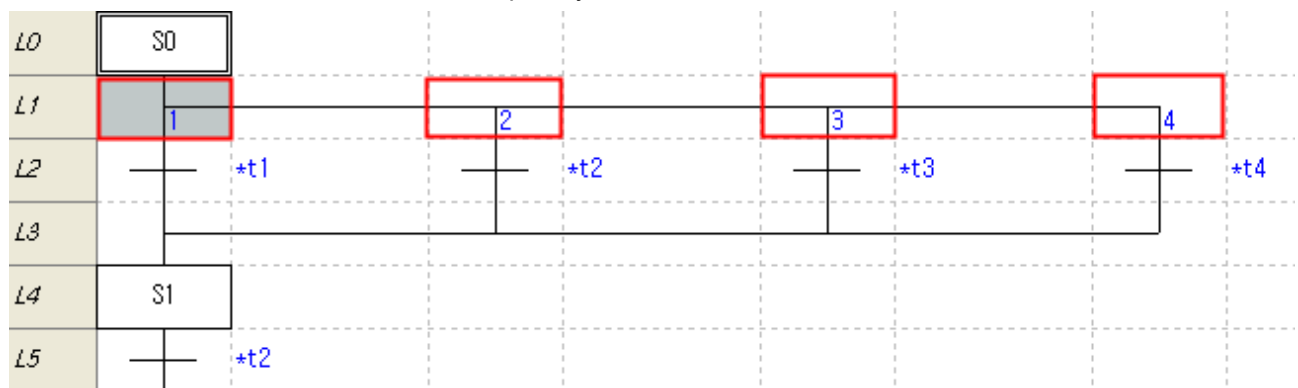

2. Select [Edit] – [Erase Branch Priority] on the menu.

3. Branch priority is erased.

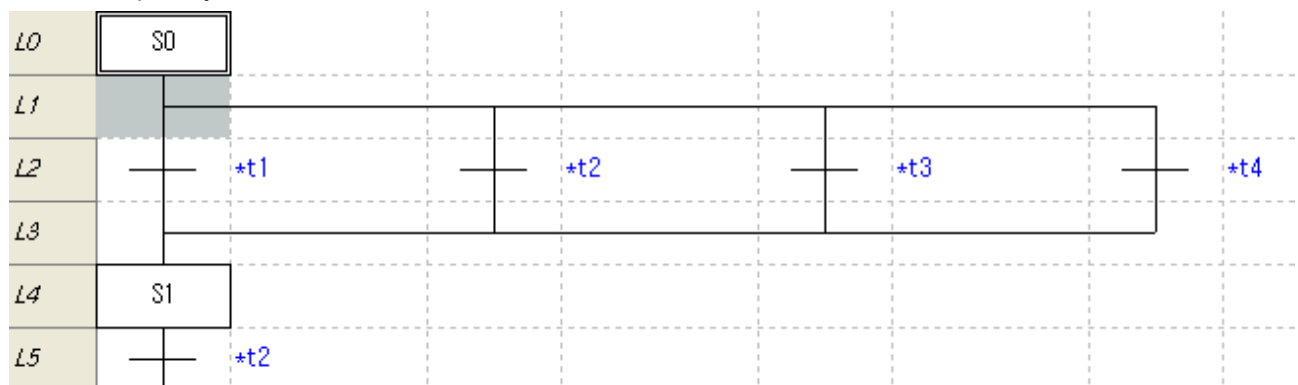

### 6.2.17 Delete Factor

Here describes how to delete step, transition, action, block, label, jump, and branch.

[Steps]

1. Move the cursor to the location where factor you want to delete exists.
2. Select [Edit]-[Delete] on the menu.

#### Notes

- The factor under step, transition and block can be deleted with step, transition and block according to selected location.
- Sometimes deleting is not available. In this case, editing is canceled automatically after warning message.
- When deleting the branch, all factors under branch is deleted.

### 6.2.18 Copy/Cut/Paste

Data can be copied from selected area or can be pasted in designated position. Cut is used to delete selected area.

#### 1) Copy/Paste

[Steps]

1. Select the area you want to copy.

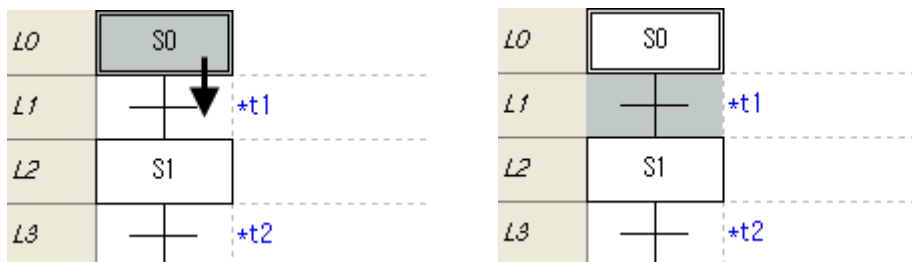

2. Select [Edit]-[Copy] on the menu.
3. Copied area is displayed.

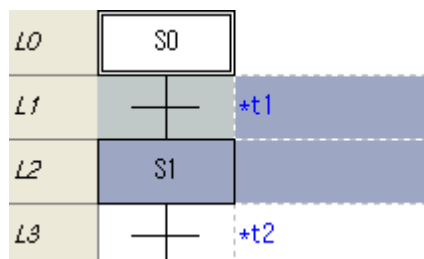

4. Move the cursor to the location you want to paste.

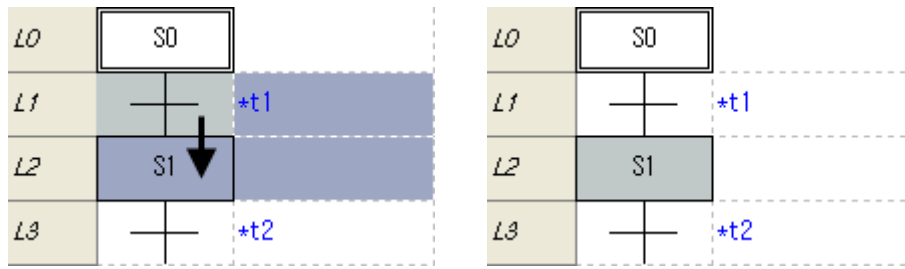

5. Select menu [Edit]-[Paste].

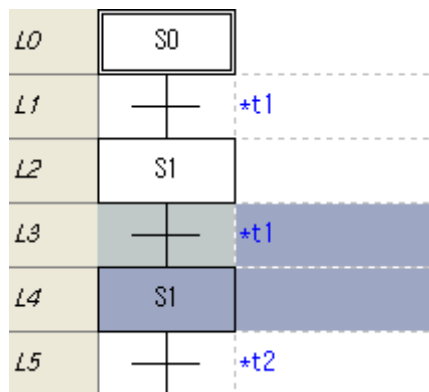

## Chapter 6 SFC Edit

### Notes

- The factor under step, transition and block can be copied with step, transition and block according to selected location.
- Sometimes pasting is not available according to the location to paste. At this time, editing is canceled automatically.
- When copying the branch start point, the factor under branch is copied with branch start point.
- When pasting the branch, select the branch start point.
- The selection branch can be pasted into the selection branch and the parallel branch can be pasted into the parallel branch.
- When pasting into the action, select the step you want to paste.
- Principal to paste is same with factor input.

### 2) Cut/Paste

[Steps]

1. Select the location to cut.

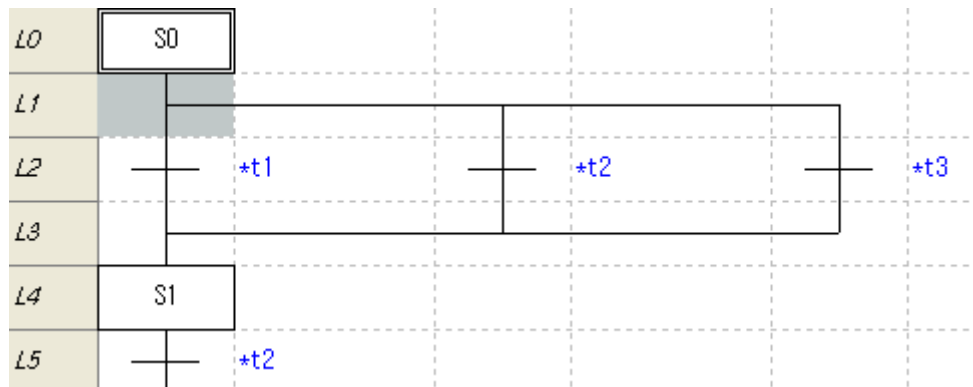

2. Select [Edit]-[Cut] on the menu.

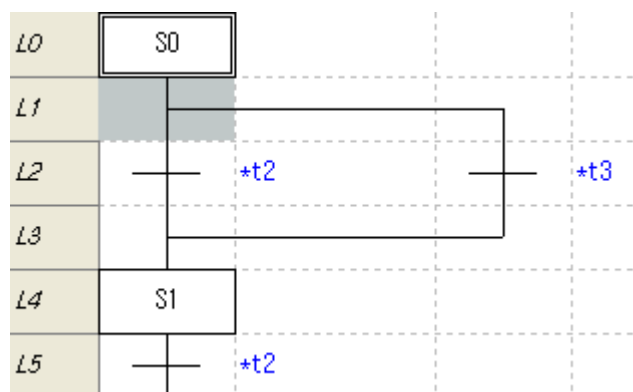

3. Move the cursor to the location to paste.

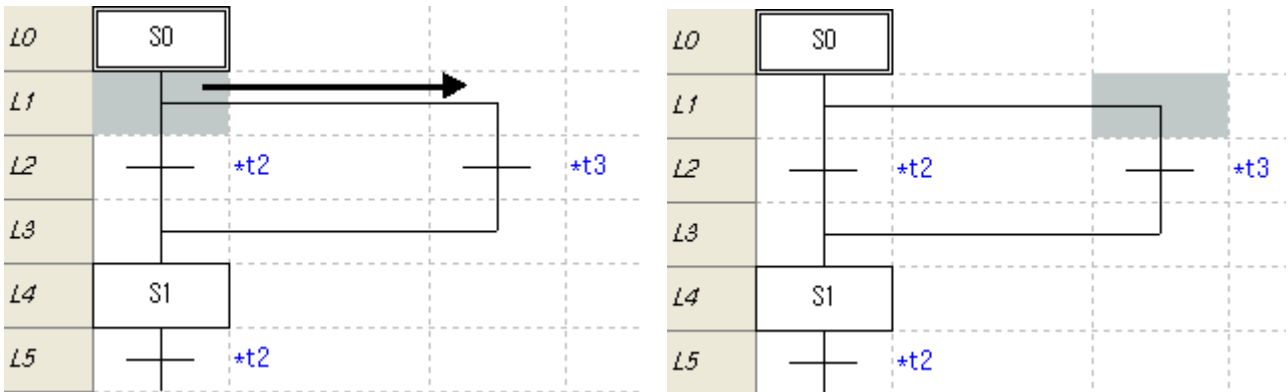

4. Select [edit]-[paste] on the menu.

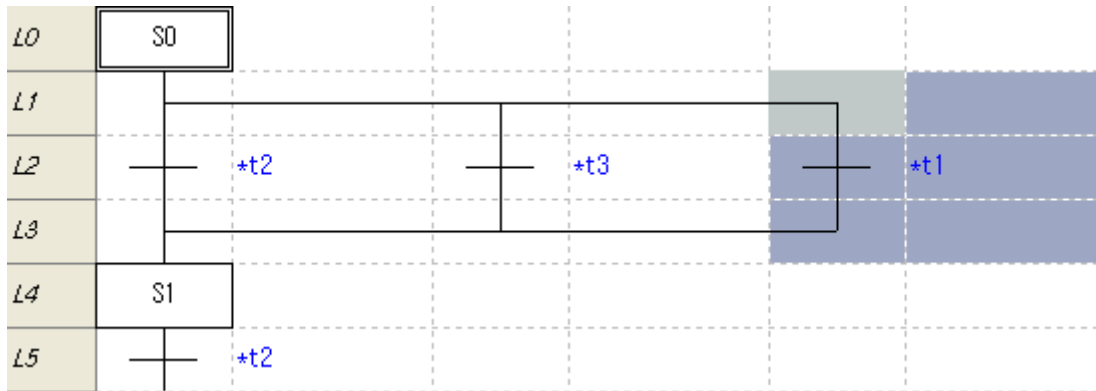



## 6.2.19 Undo and Redo

Here describes how to undo and redo contents.

### 1) Undo (example)

[Steps]

1. Move the cursor to the location you want to delete.

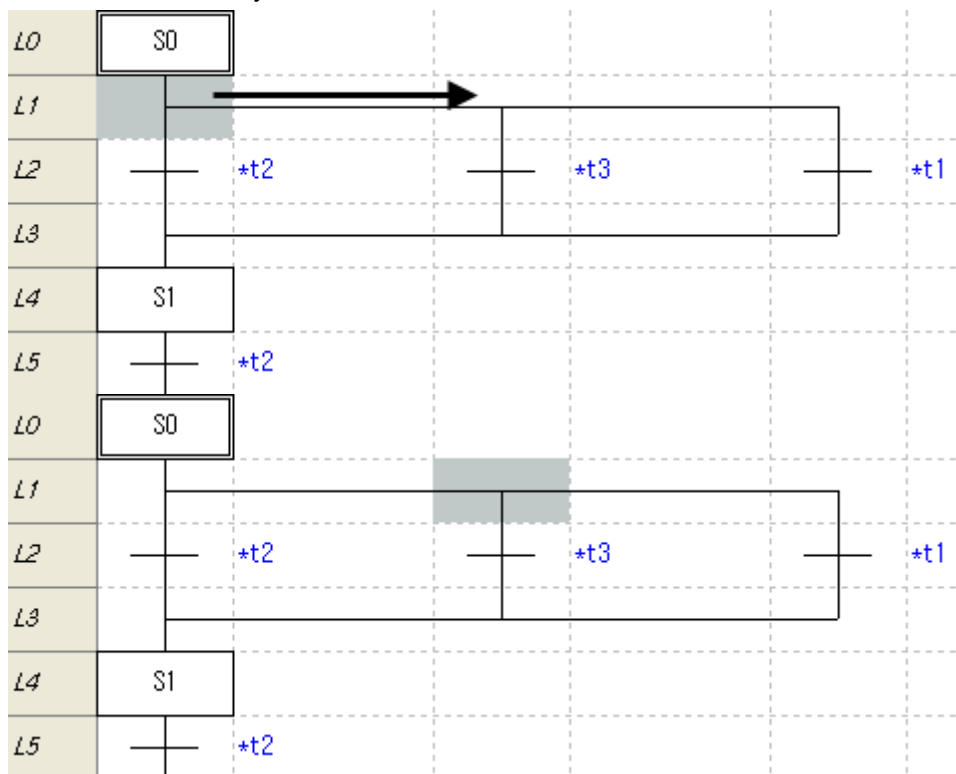

2. Select [Edit]-[Delete] on the menu.

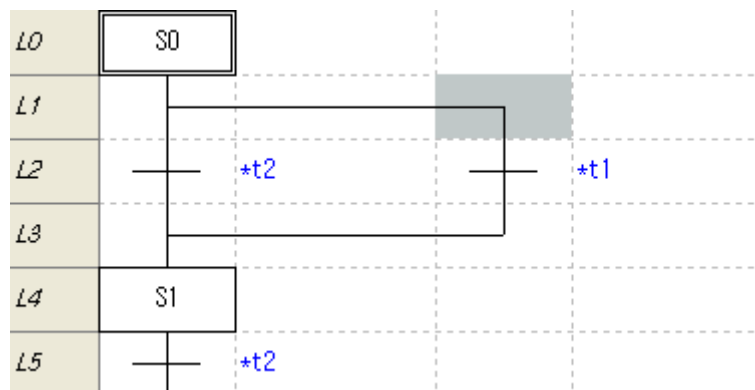

3. Select [Edit]-[Undo] the menu.

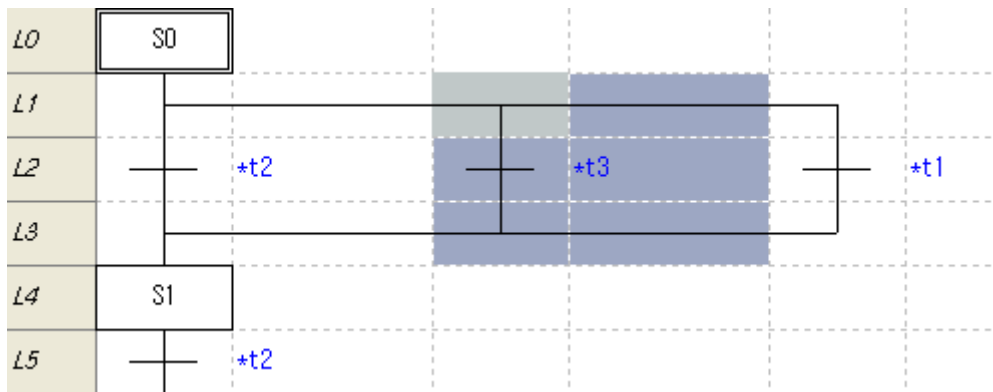

4. Editing is canceled.

2) Redo (Example)

1. Select [Edit]-[Redo] the menu.

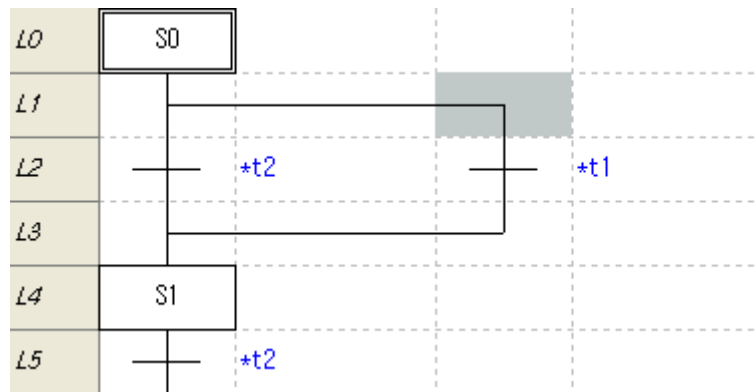

**Notes**

- Undo and Redo is available about all factor edited.
- It doesn't matter how many times you undo.

**6.2.20 Program Edit Mode**

SFC program supports only insert mode.

Insert mode: Offline Row 6, Column 1 Insert

### 6.3 View Program

Here describes how to zoom in or out

#### 6.3.1 Program zoom In/Out

Here describes how to zoom in or out.

##### 1) Zoom In

[Steps]

1. Select [View]-[Zoom In] on the menu.

##### 2) Zoom Out

[Steps]

1. Select [View]-[Zoom Out] on the menu.

#### Notes

- Ctrl + Upward Wheel if available perform Zoom-Out step by step.
- Ctrl + Downward Wheel if available perform Zoom-In step by step.
- On the View Tool selection box, the user can select or directly input the magnification. Refer to 2.2 Tool Box in Chapter 2 Basic Application for more details.



### 6.3.2 SFC Property

Here describes how to edit SFC property.

[Steps]

1. Select menu [View]-[SFC].

[Dialog box]

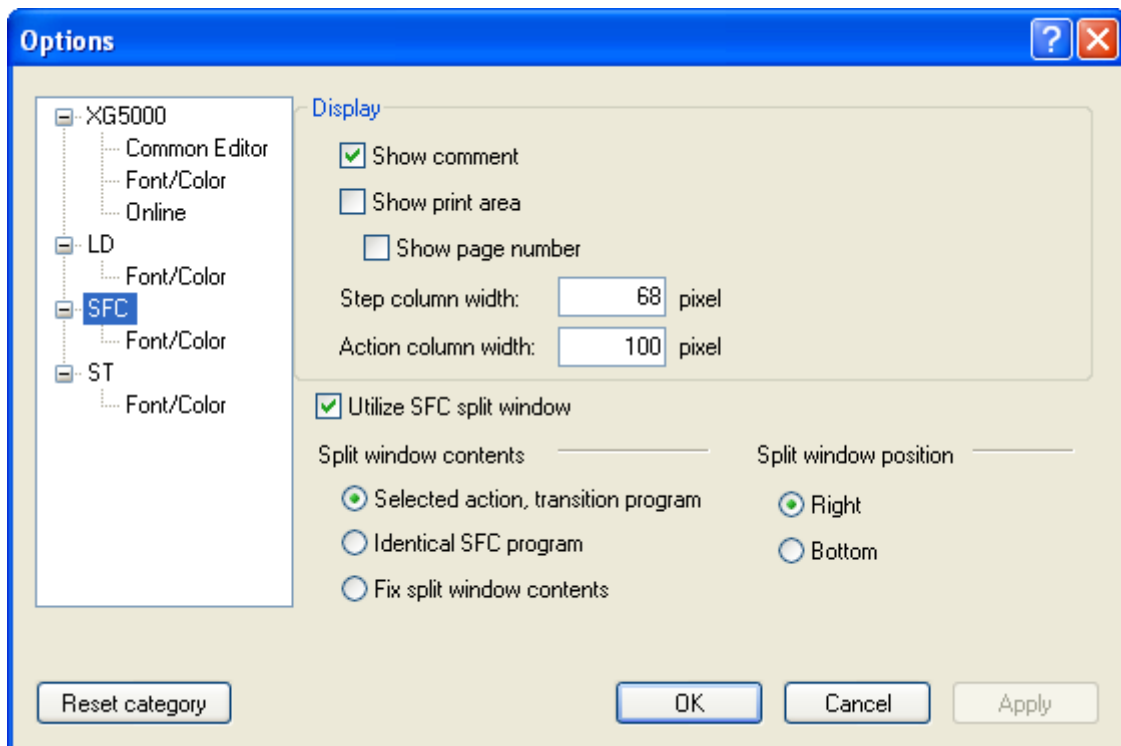

[Dialog box description]

- a. Show comment: displays the comment of step, transition, action and block.
- b. Show print area: displays the printing area with thick dotted line.
- c. Show page number: displays page no. printed in the print area.
- d. Step column width: sets width of vertical column of step, transition location.
- e. Action column width: displays width of vertical column of action location.
- f. Utilize SFC split window: You can use SFC split window
- g. Split window position: You may decide in which direction the window gets divided.
- h. Split window contents: You may decide which contents the program displays in the split window.
- i. OK: Saved the setting and close the window.
- j. Cancel: Cancel the setting.
- k. Apply: Apply the setting.
- l. Reset category: Reset to default value of XG5000.

## Chapter 6 SFC Edit

### Notes

- Step column width's range is 20~200.
- Action column width's range is 70~400.

### 1) Show comment

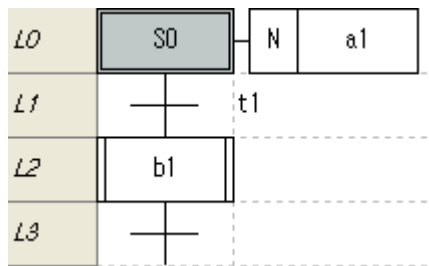

<Not Showing comment>

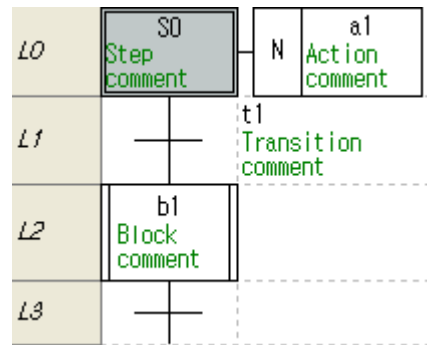

<Showing comment>

### 2) Show print area

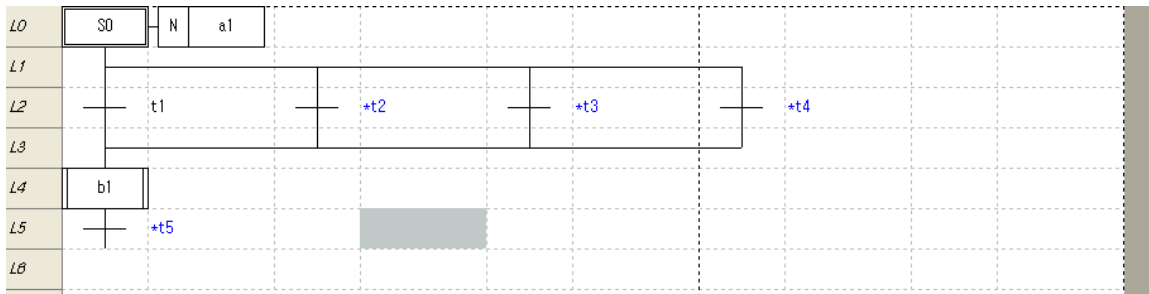

### 3) Show page number

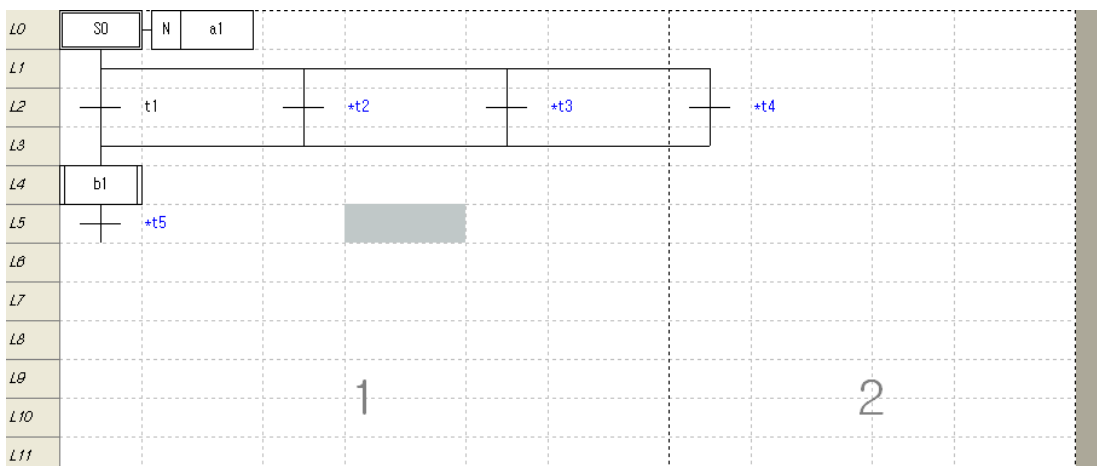

4) Step column width

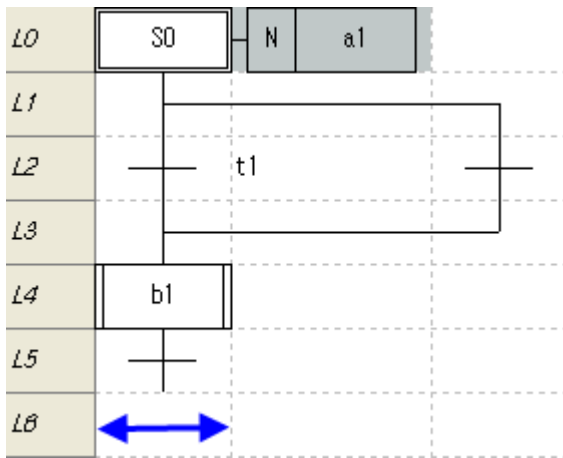

<Step column 68 pixel (basic) screen>

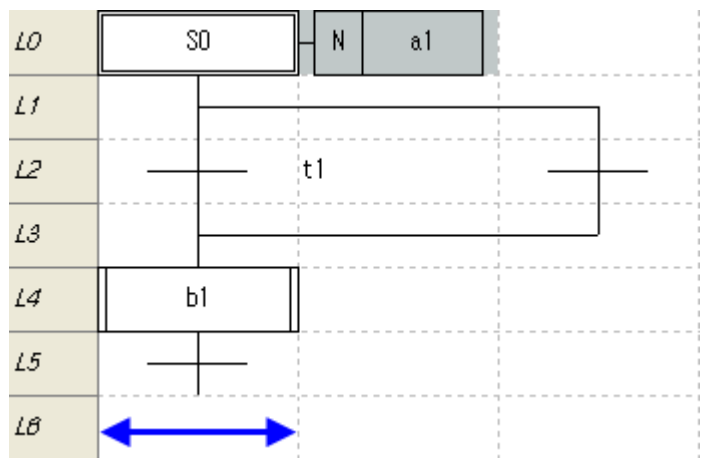

<Step column 100 pixel screen>

5) Action column width

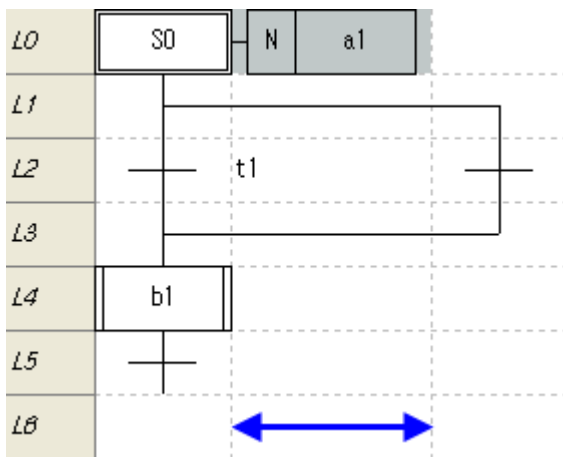

<Action column 100 pixel (basic) screen>

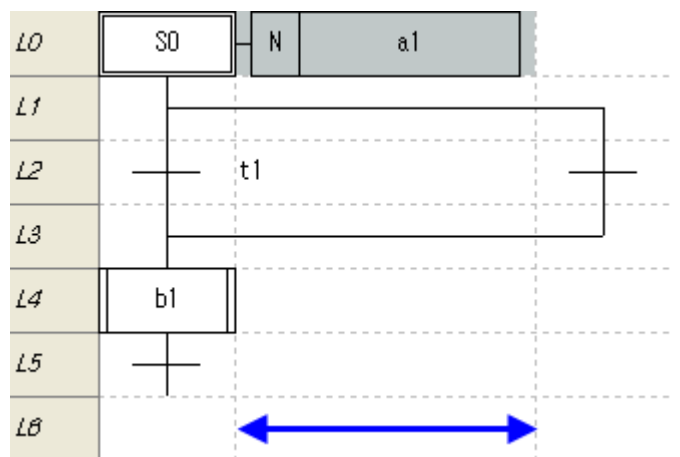

<Action column 150 pixel screen>

# Chapter 6 SFC Edit

## 6) Utilize SFC split window

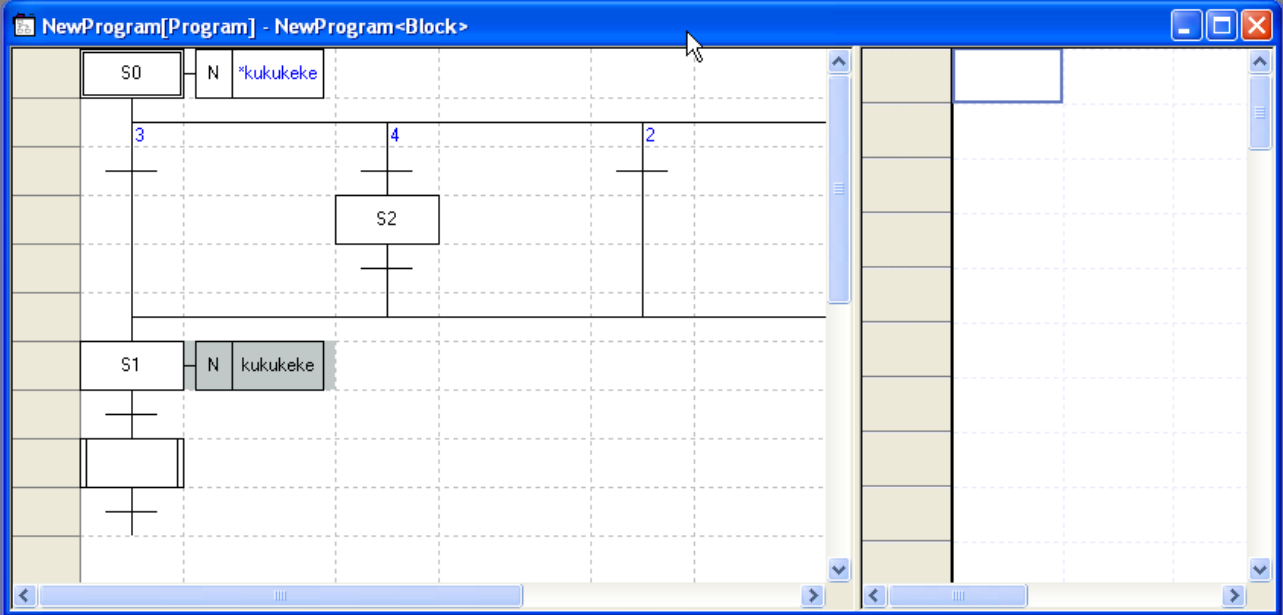

<With split window>

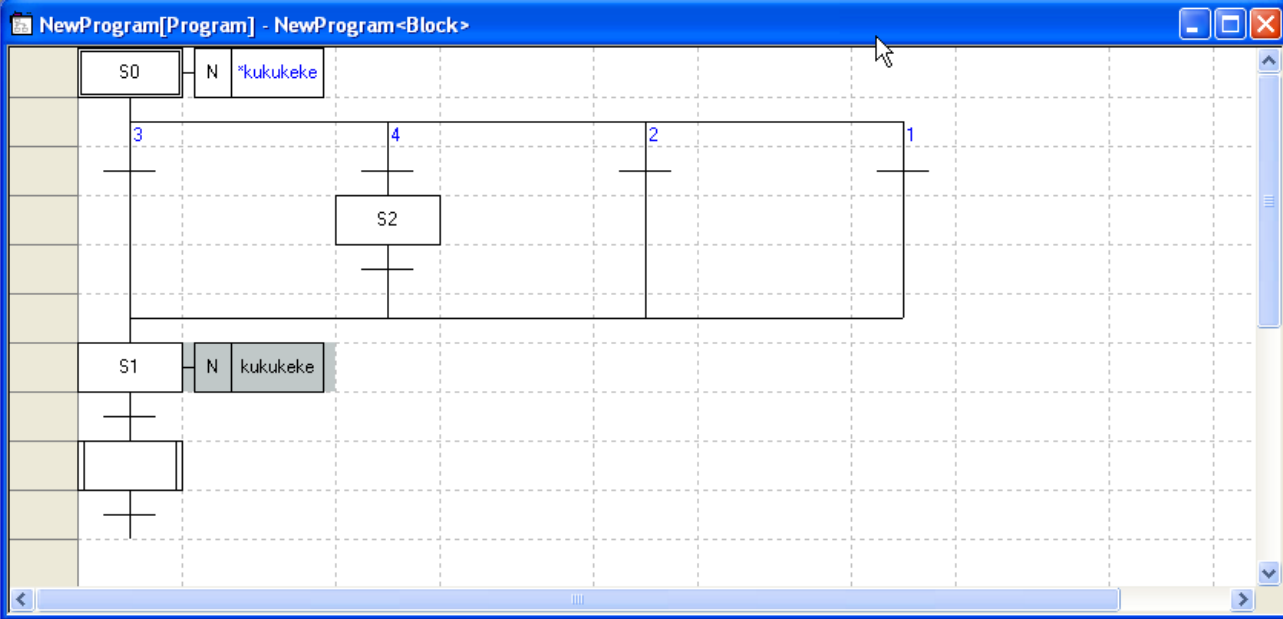

<Without split window>

7) Split window contents

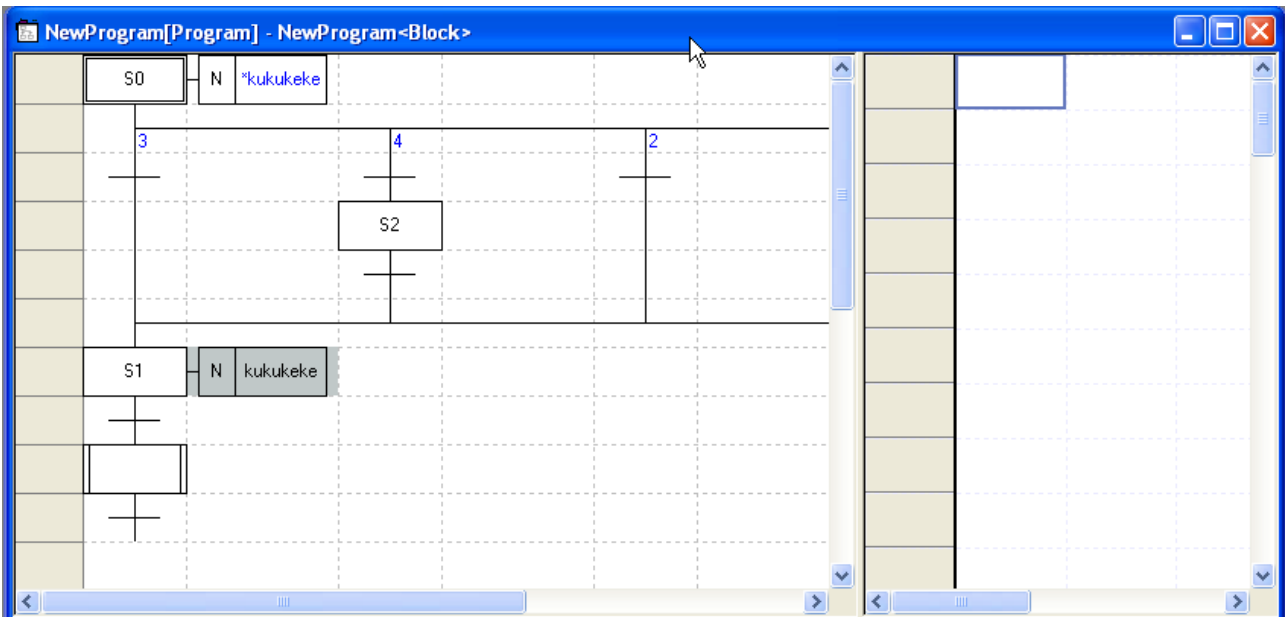

<Viewing the selected action, transition: when selecting action>

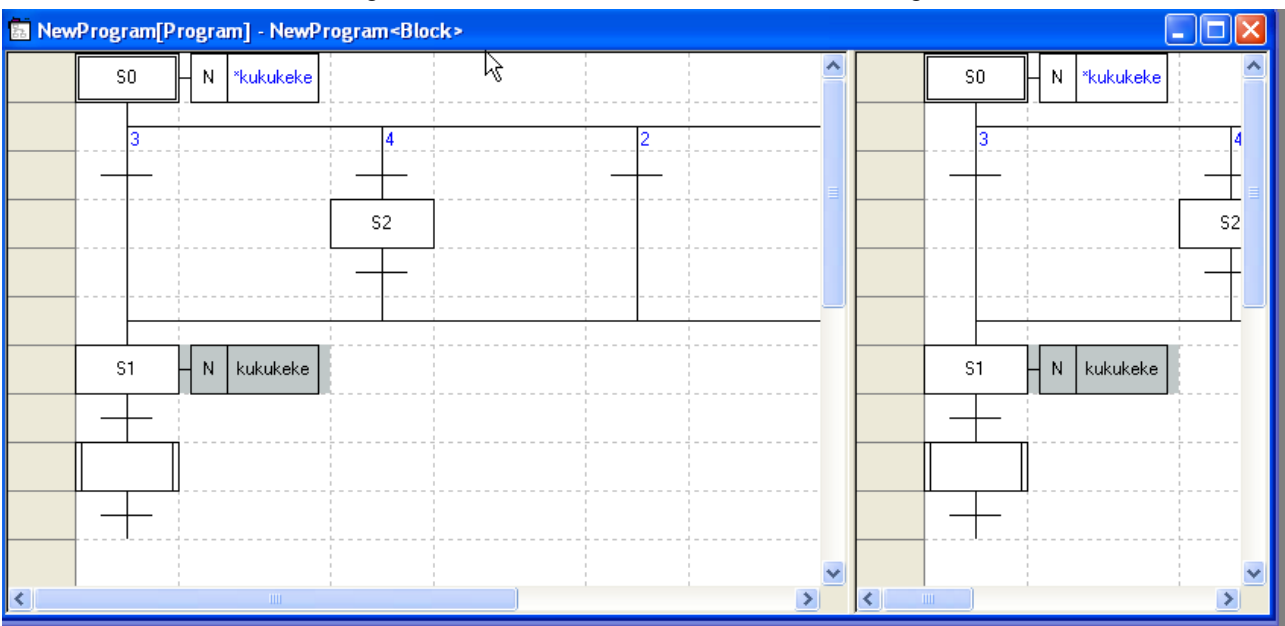

<Viewing the identical SFC program>



# Chapter 6 SFC Edit

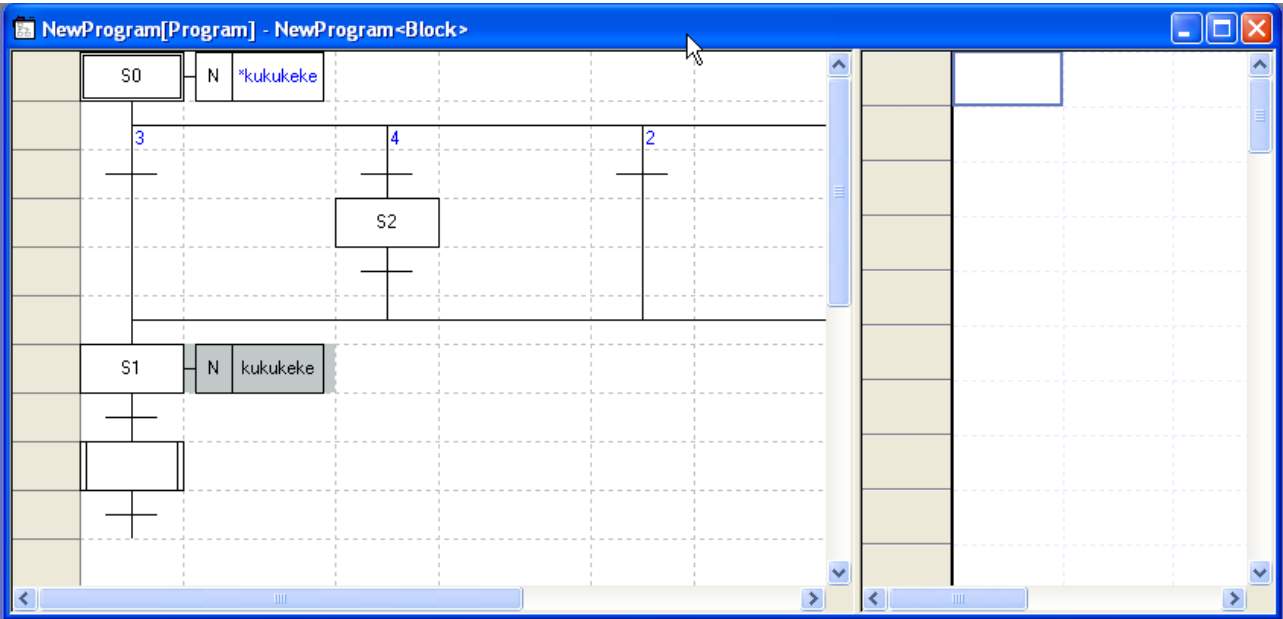

<Viewing the fix split window contents: displays the previous screen>

## 8) Split window position

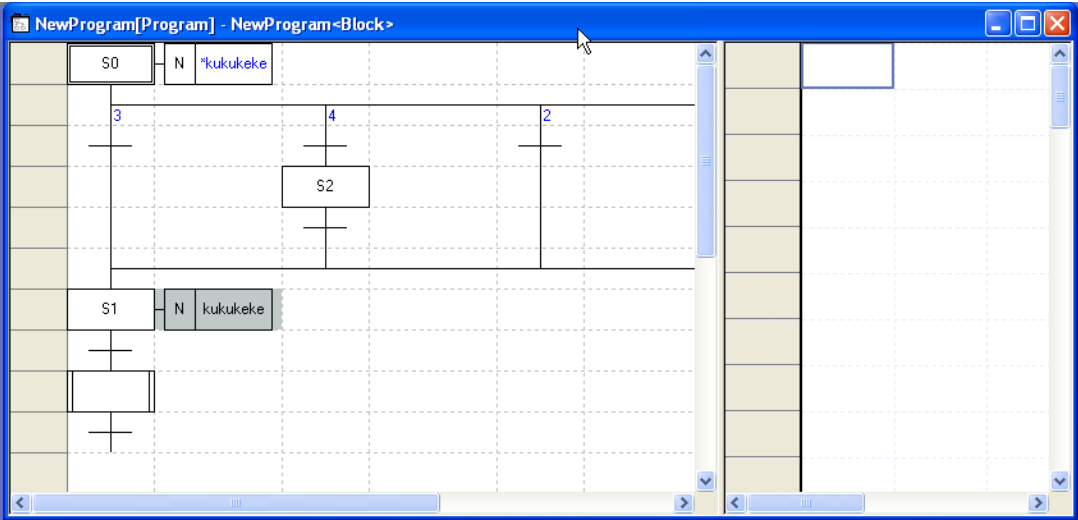

<Right>

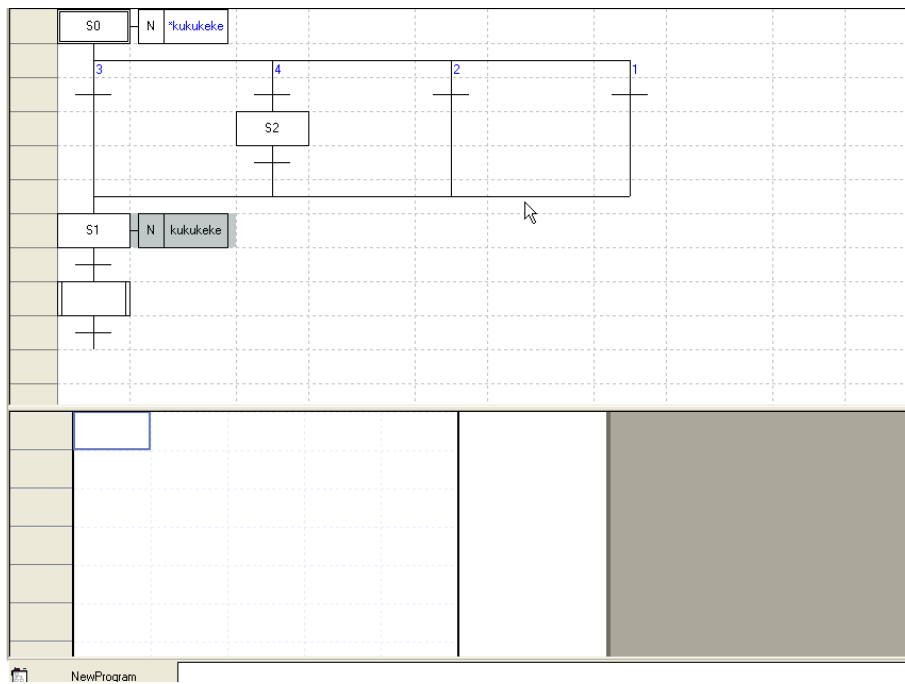

<Bottom>

### 6.3.3 View Block/Action/Transition List

You can check other program list used in the SFC program and edit name and comment.

[Steps]

1. Select menu [View]-[Block/Action/Transition List].
2. Displays list.

### 6.3.4 Open Action/Transition

In the SFC program, open the selected action, transition with the new window

[Steps]

1. Move the cursor to the location you want to open program.

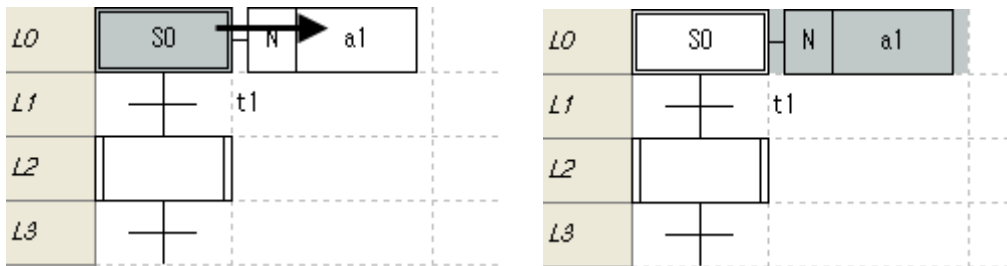

2. Select [View]-[Open Action/Transition] on the menu.
3. Open the selected program with the new window.

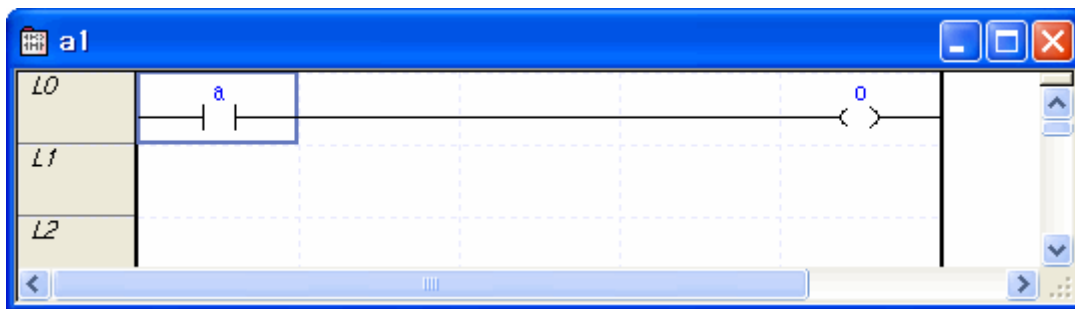

### 6.3.5 Devices/Variables

Displays variables or devices used in the contact, coil, function (block) as Devices/Variables name. If variable doesn't have device, it displays variable name.

[Steps]

1. Select [View]-[Devices/Variables] the menu.

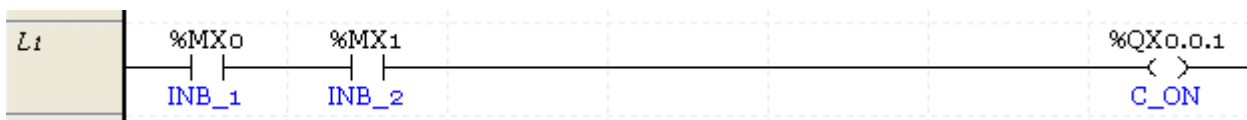

### 6.3.6 Devices/Comments

Displays variables or devices used in the contact, coil, function (block) as Devices/Comment. If variable doesn't have device, it displays variable name.

[Steps]

1. Select menu [View]-[Device/Comments].

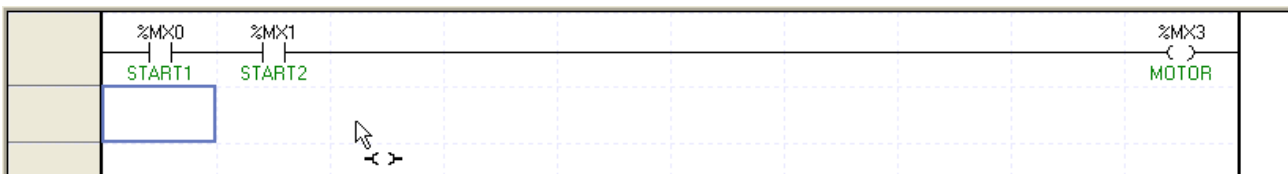

#### Notes

- When changing the above option, it will take time according to program amount.
- When printing, Devices/Variables/Comments is supported. For more details, refer to the Ch. 14.

### 6.3.7 Adjust Contact No.

It is used to adjust the number of contact points displayed in the screen. Here, the number of contact points is total number (horizontal cell - 1), excluding the output position.

[Steps]

1. Select [View]-[Change columns]-[contact no.] on the menu.

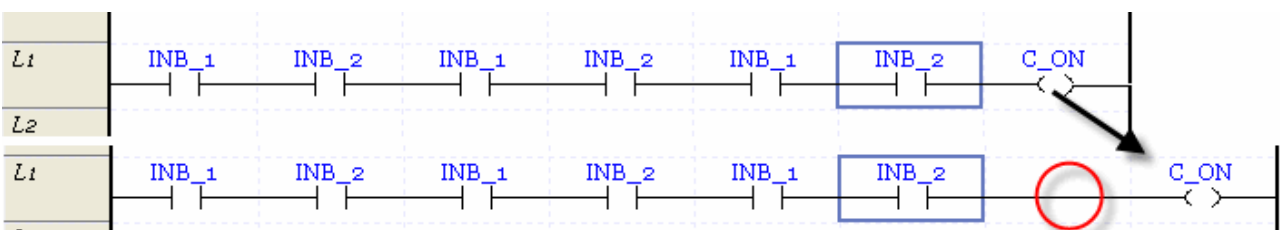

If the data in the very right of the present screen is larger than the number of contact points to display, it may be displayed by rung including arrow.

## Chapter 6 SFC Edit

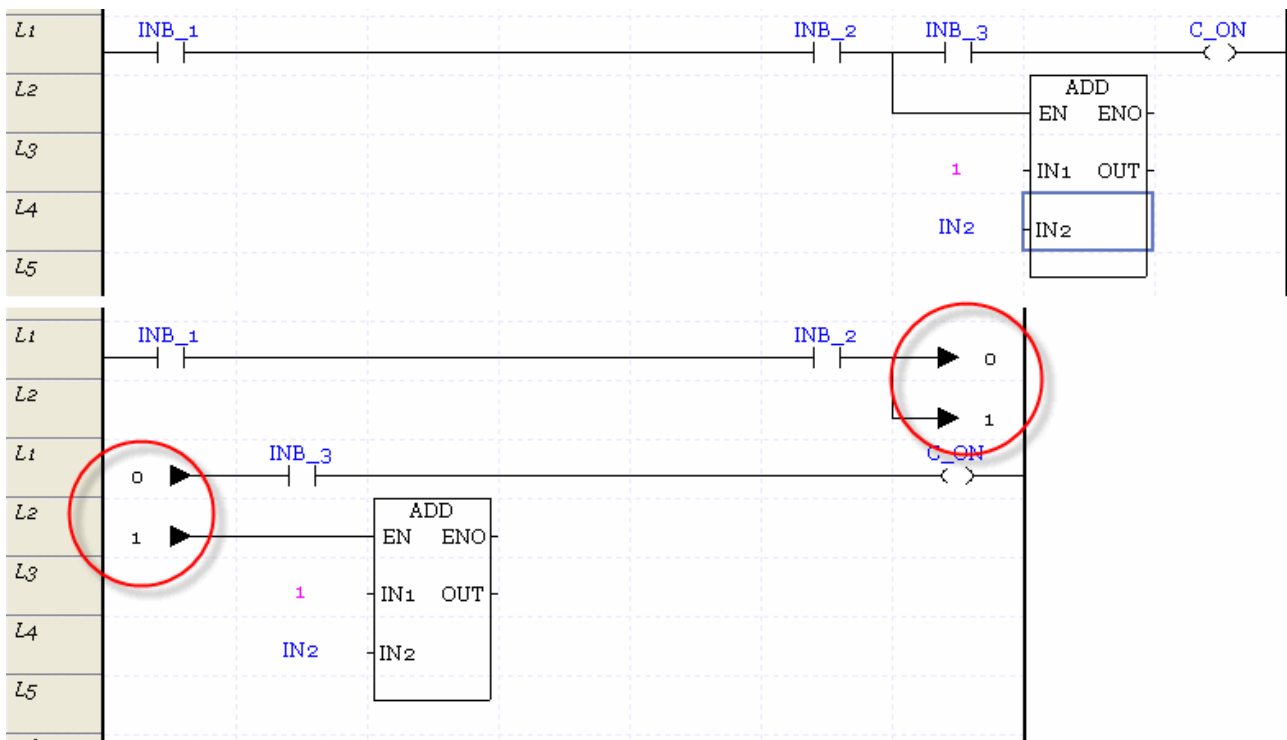

### Notes

- It may increase or decrease one by one in [View]-[Toolbox].



- The number of contact to set is 9 ~ 31.
- The number of contact points minimally set in LD program used for SFC action and transition is 5

### 6.3.8 LD Properties

In here, you can edit [View Options] about device, variable, comment, [Magnification] and [No. of Contacts] at once.

[Steps]

1. Select [View]-[LD Properties] on the menu.
2. After editing the LD properties, press 'OK'.

[Dialog box]

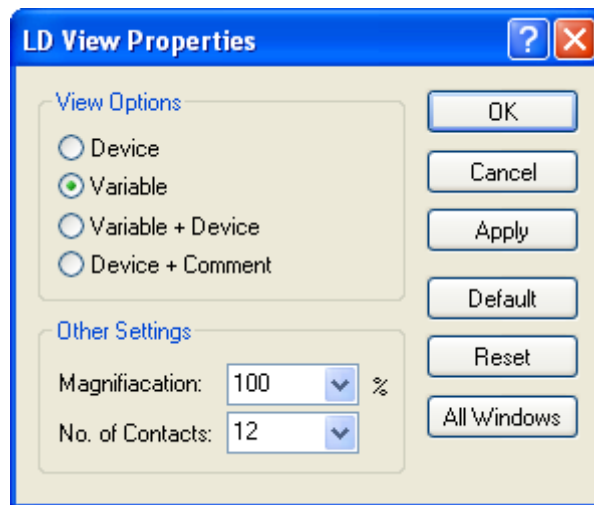

[Dialog box description]

- a. View Options: designates View Option about variable and device.
- b. Magnification: designates magnification. Range is 40~200%.
- c. No. of Contact: designates no. of contact.
- d. OK: saves the content and closes window.
- e. Cancel: closes dialog box.
- f. Apply: applies setting contents to LD window.
- g. Default: sets current setting as default. When you make new LD program, it is displayed with current setting.
- h. Reset: restores the current setting to the basic setting.
- i. All Windows: applies the current setting to all windows.

#### Notes

- You can't designate Devices/Variables/Comments in the [View Option].
- In case of all Windows, applies the setting to all SFC program action and transition, function (block) written by LD.

## 6.4 Edit additional Function

For convenience of edit, here describes additional function.

### 6.4.1 Bookmark

If you set Bookmark, you can go there easily.

#### 1) Bookmark setting

[Steps]

1. Move the cursor to the location you want to set bookmark.

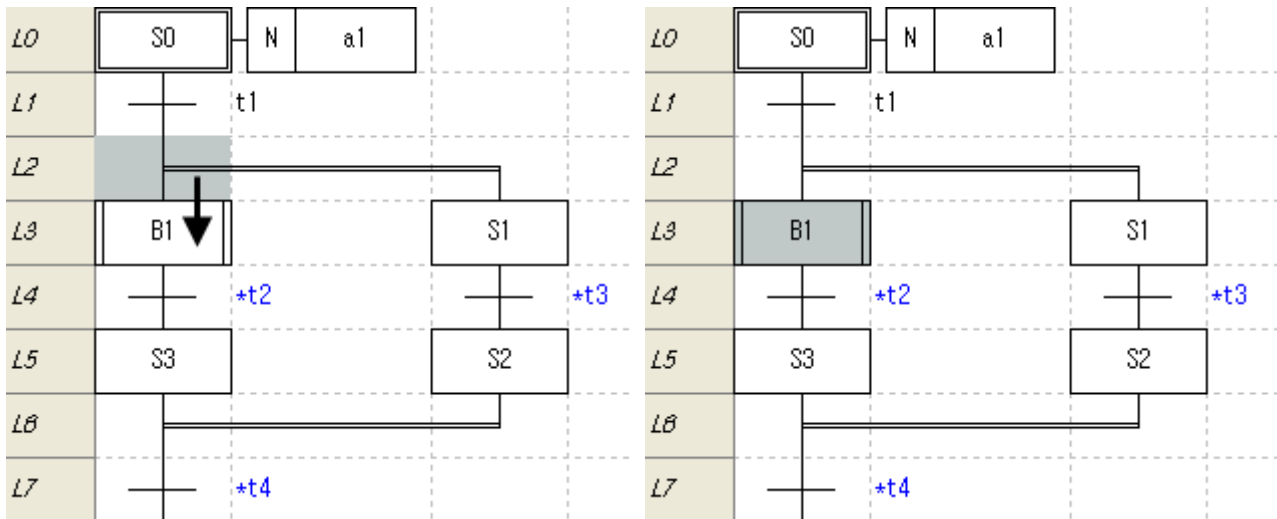

2. Select [Edit]-[Bookmark]-[Set/Remove] on the menu.

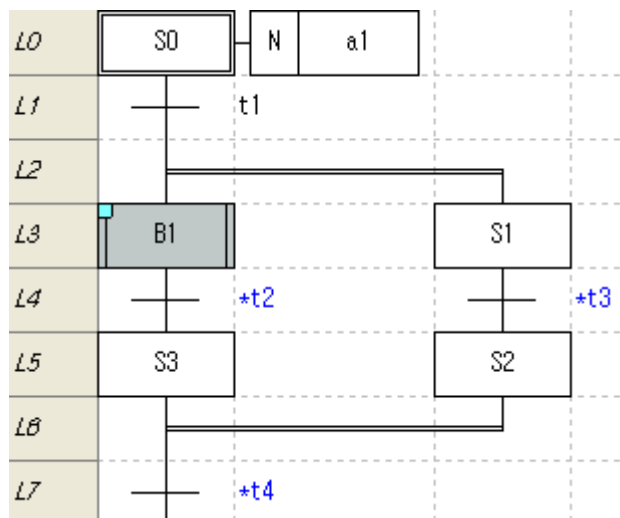

2) Remove Bookmark

[Step]

1. Move the cursor to the location you want to remove bookmark.

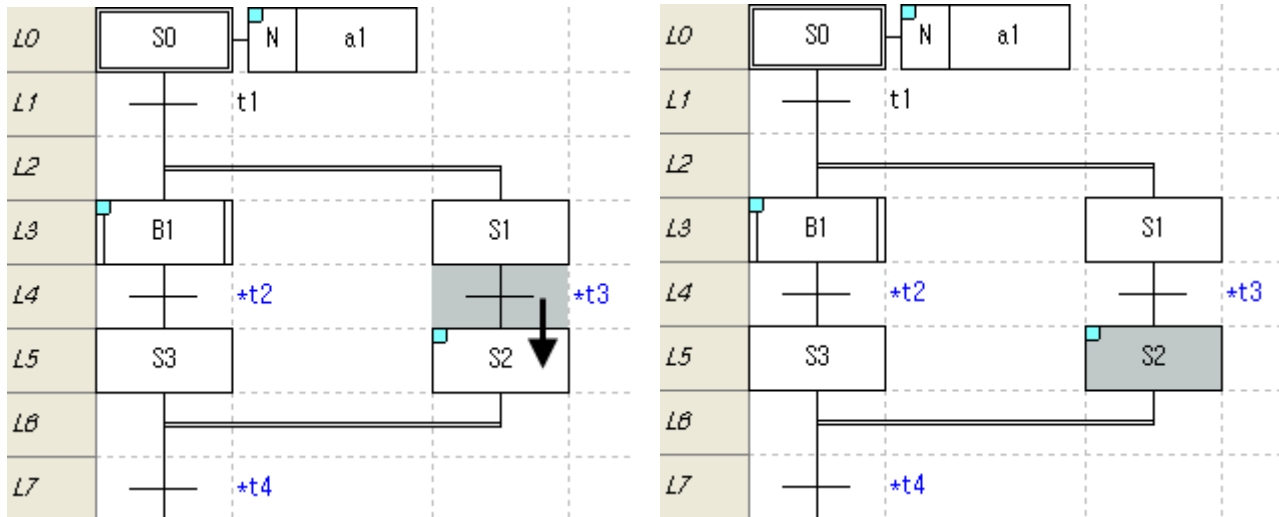

2. Select [Edit]-[Bookmark]-[Set/Remove] on the menu.

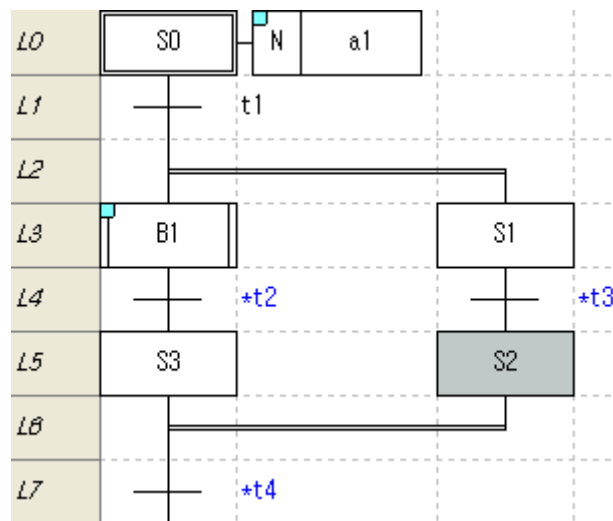



## Chapter 6 SFC Edit

### 3) Remove all bookmark

[Steps]

1. Select [Edit]-[Bookmark]-[Remove all] on the menu.

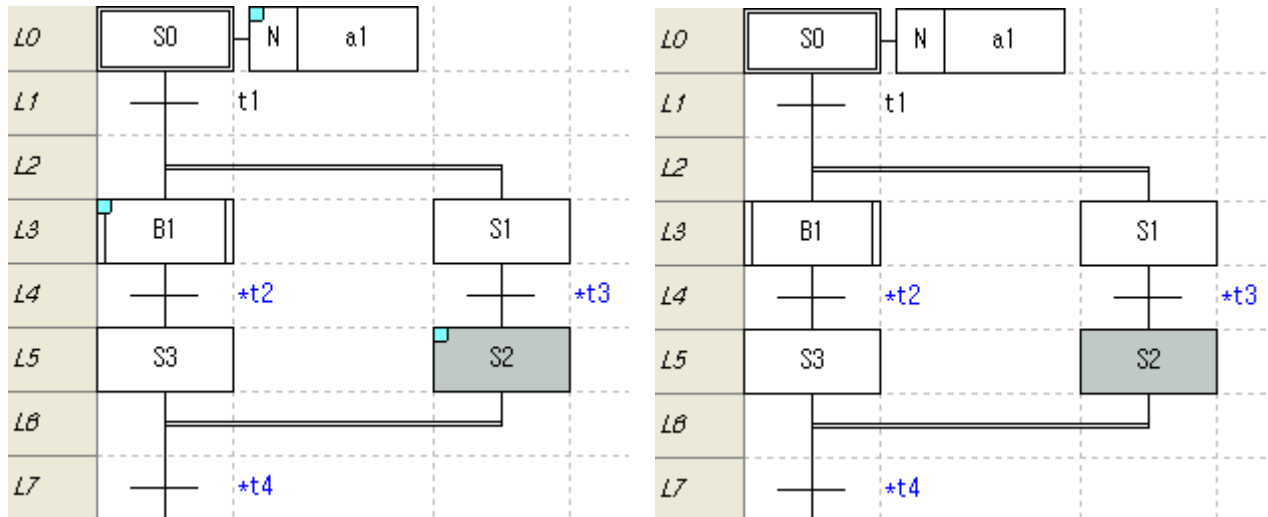

### 4) Previous Bookmark

[Steps]

1. Select [Edit]-[Bookmark]-[Previous Bookmark] on the menu.

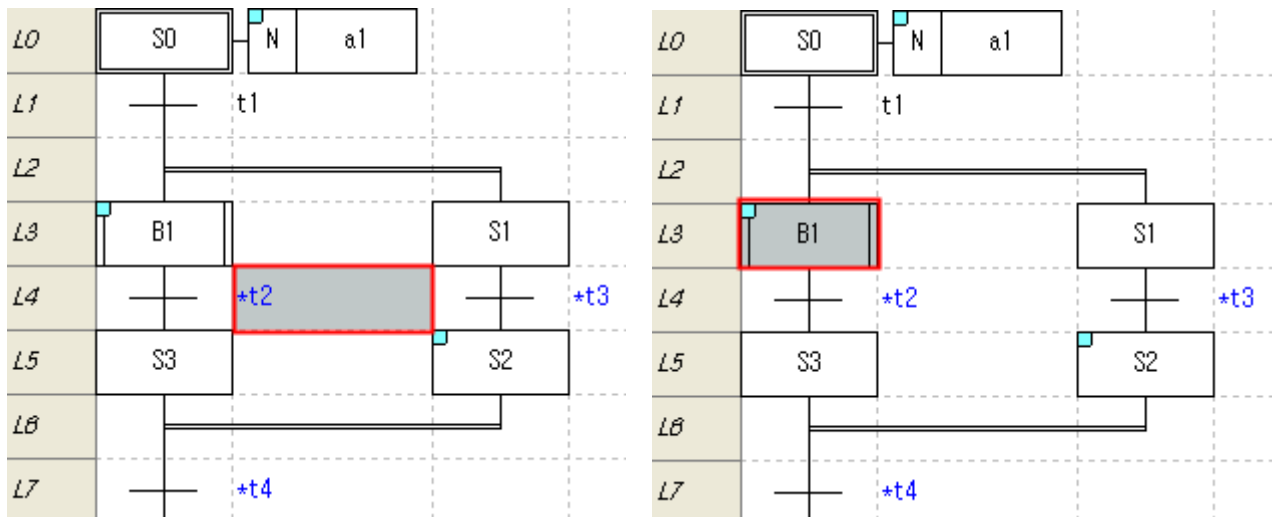

5) Next Bookmark

[Steps]

1. Select [Edit]-[Bookmark]-[Next Bookmark] on the menu.

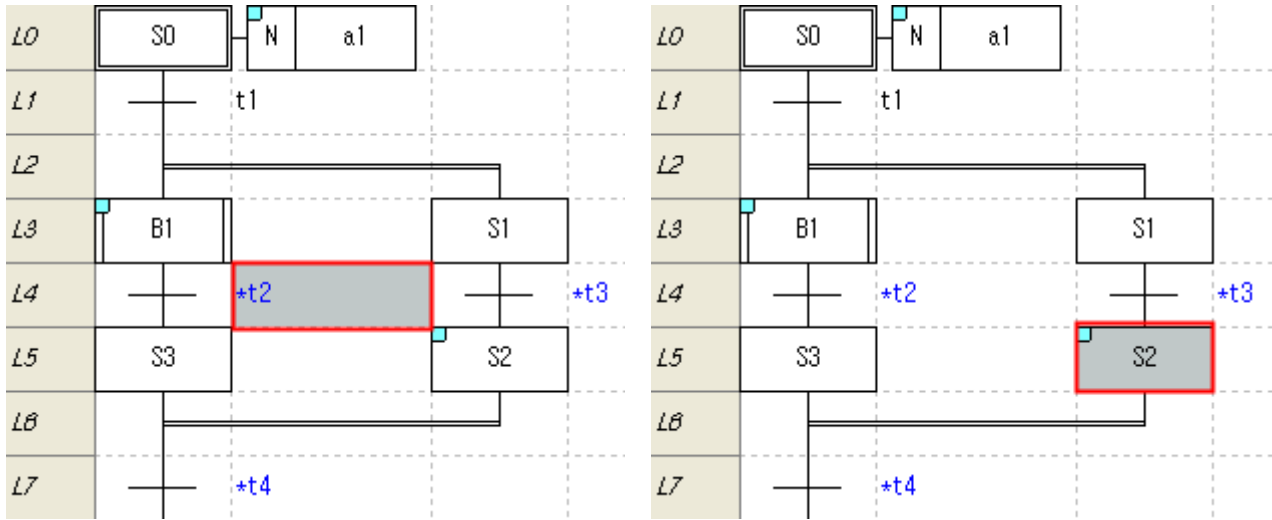

Notes

- Bookmark will be specified in cell unit.
- Bookmark is not an item to edit, thus the Set/Reset options will not be included in Undo and Redo.

### 6.4.2 Go To

You can go to designated line, edited label, rung comment.

#### 1) Go to Step/Line

[Steps]

1. Select [Find/Replace]-[Go To]-[Step/Line] on the menu.

[Dialog box]

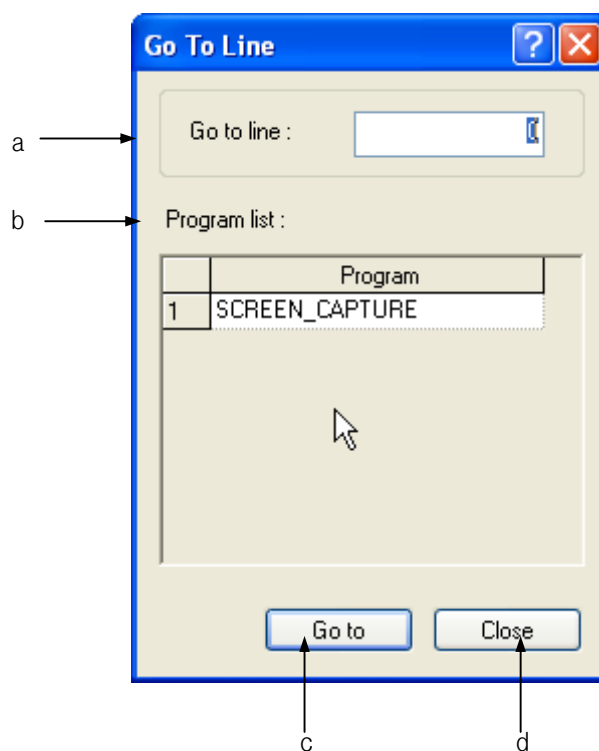

[Dialog box description]

- a. Go to line: inputs line you want to go.
- b. Program list: displays the program list of PLC.
- c. Go to: closes dialog box and goes to selected step.
- d. Close: Closes dialog box.

2. Input step you want to move in the dialog box.

#### Notes

- Go To Line is available in the LD program.
- It doesn't operate in the LD used in the SFC Action/Transition.

## 2) Go To Label

[Steps]

1. Select [Find/Replace]-[Go To]-[Label] on the menu.

[Dialog box]

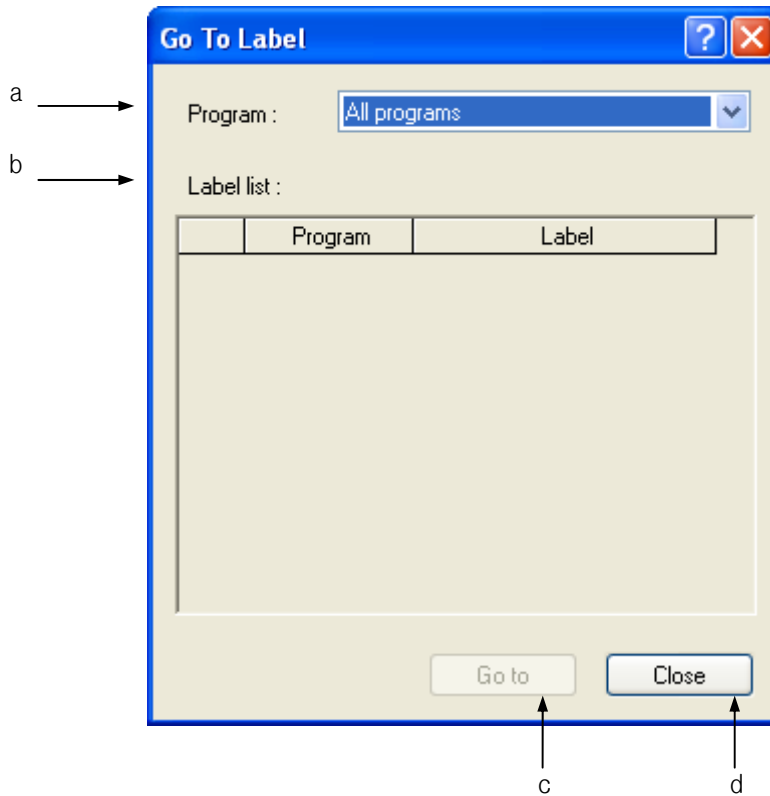

[Dialog box description]

- a. Program: displays current PLC program list. If you select 'All program', it displays list of all label.
- b. Label list: displays list of label used in the selected program.
- c. Go to: closes dialog box and goes to selected label.
- d. Close: closes dialog box without save.

2. Select label you want to go in the dialog box.

**Notes**

- Go To Label operates in the LD program.
- It doesn't operate about LD used in the SFC program's Action/Transition.

## Chapter 6 SFC Edit

### 3) Go To rung comment

[Steps]

1. Select [Find/Replace]-[Go To]-[Rung comment] on the menu.

[Dialog box]

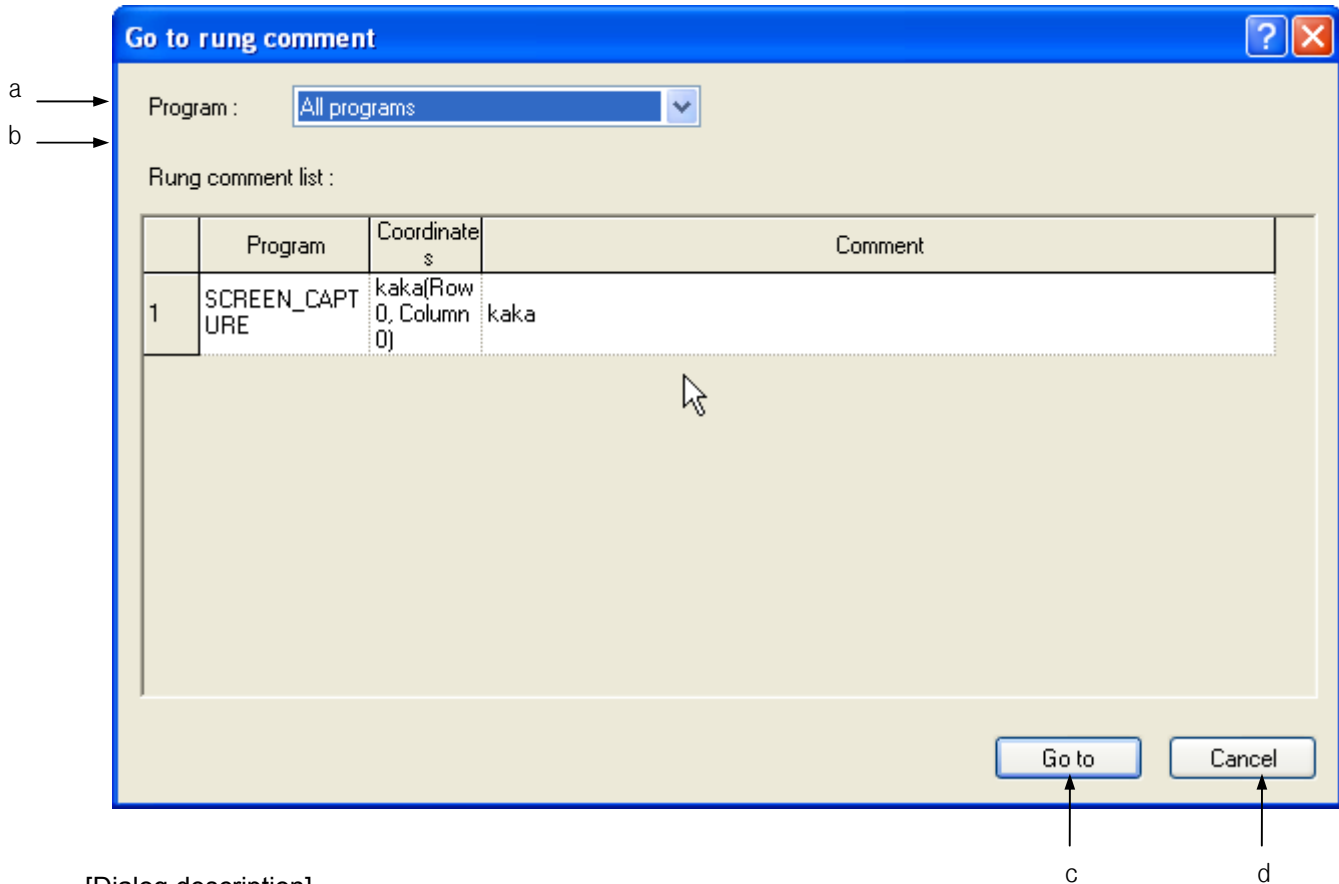

[Dialog description]

- a. Program: displays current PLC program list. If you select 'All program', it displays list of all rung comment.
- b. Label list: displays list of rung comment used in the selected program.
- c. Go to: closes dialog box and goes to selected rung comment.
- d. Close: closes dialog box without save.

2. Select the rung comment you want to go.

### Notes

- Go To Rung Comment is available in the LD program.
- It doesn't operate about LD used in the SFC program's Action/Transition.

## 4) Go To END Command

[Steps]

1. Select [Find/Replace]-[Go To]-[END Command] on the menu.

[Dialog box]

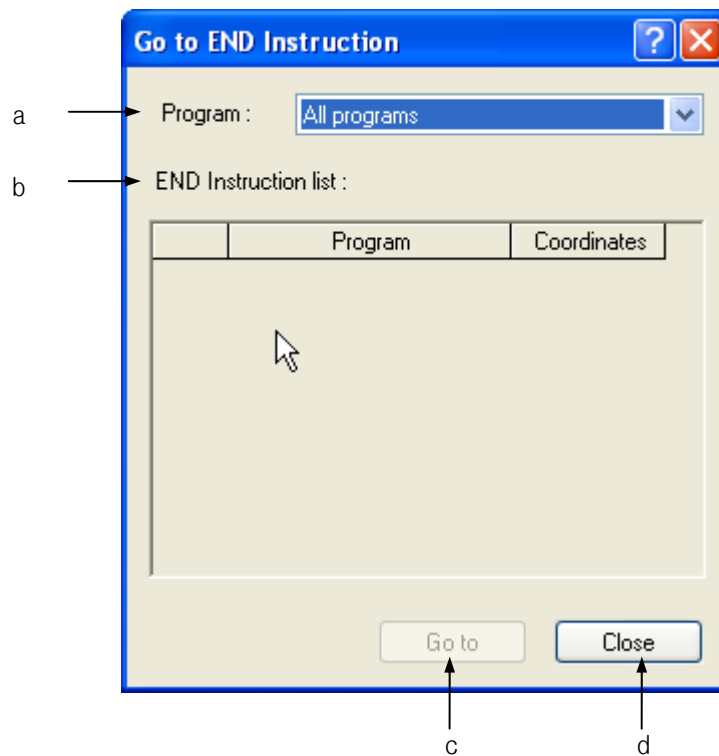

[Dialog box description]

- a. Program: displays current PLC program list. If you select 'All program', it displays list of all END command.
- b. Label list: displays list of END command used in the selected program.
- c. Go to: closes dialog box and goes to selected END comment.
- d. Close: closes dialog box without save.

2. Select the END command you want to go.

**Notes**

- Go To END command is available in the LD program.
- It doesn't operate about LD used in the SFC program's Action/Transition.

## Chapter 7 Programming Convenience

### 7.1 Cross Reference

It is used to display the application details of all the devices and variables used in the program. It includes contact points (normally open contact point, normally closed contact point, positive-conversion detection contact point and negative-conversion detection contact point), coils (coil, reverse coil, positive-conversion detection coil and negative-conversion detection coil), I/O parameter of function(block) and all the devices and variables used as the operand of extended function.

#### 7.1.1 View All Device

It is used to display all the devices used in the present PLC.

[Steps]

1. Select [View] - [Cross Reference] on the menu.

[Cross Reference Window]

Device Name	Variable	PLC	Program	Position	Comment	Information
	_STOG	NewPLC	modbus[Program]	Row 1, Col...	Every scan Toggle	- -
	_STOG	NewPLC	modbus[Program]	Row 5, Col...	Every scan Toggle	- -
%MX0	INB_1	NewPLC	modbus[Program]	Row 0, Col...	INB_2comment	- -
%MX1	INB_2	NewPLC	modbus[Program]	Row 0, Col...	C_ONcomment	- -
%QX0.0.1	C_ON	NewPLC	modbus[Program]	Row 0, Col...	INB_1comment	- -
A1.0	SCAN_CNT	NewPLC	modbus[Program]	Row 6, Col...		- VAR -
A1.0	SCAN_CNT	NewPLC	modbus[Program]	Row 7, Col...		- VAR -

[Description of Cross Reference Window]

Column	Details
Device Name	Displays the names of all the devices used in the present PLC
Variable	Displays the names of all variables used in the present PLC.
PLC	Displays names of PLC belonging to the present program
Program	Displays name of the program using the applicable device.
Position	Displays the coordinates inside the program.
Comment	Displays the comment of device and variable.
Information	The following signs are displayed for the type of instructions;

## Chapter 7 Programming Convenience

Column	Details
	-(): Coil
	-(/)-: Reverse coil
	-(S)-: Set coil
	-(R)-: Reset coil
	-(P)-: Positive-conversion detection coil
	-(N)-: Negative-conversion detection coil
	-    -: Normally open contact point
	- /  -: Normally closed contact point
	- P  -: Positive-conversion detection contact point
	- N  -: Negative-conversion detection contact point
	-[F]-: Extended function parameter
	-VAR-: Function(block) I/O parameter

### 1) Data Alignment

Click the column header to align the applicable column. Whenever the column is clicked, it will be aligned in the ascending and then descending sequence repeatedly. A triangle will be displayed on the basic column of the present alignment. The normal triangle means that the alignment is in the ascending sequence, and the reverse triangle means that the alignment is in the descending sequence.

*Example.1)* Alignment in the ascending sequence based on the device names

△ Device ...	Variable	PLC	Program	Position	Comment	Information
--------------	----------	-----	---------	----------	---------	-------------

*Example.2)* Alignment in the descending sequence based on the device names

▽ Device ...	Variable	PLC	Program	Position	Comment	Information
--------------	----------	-----	---------	----------	---------	-------------

### 2) Go To

It is used to go to the position of the program using the selected device. Double-click the applicable line, or click the right mouse button to select [Go To] on the menu.

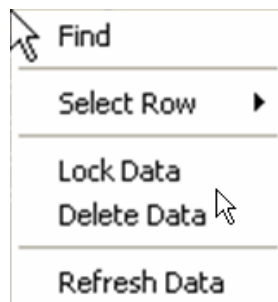



### 3) Select Row

It is used to display the desired data only on the screen. Click the right mouse button to select each item on the menu [Select Row].

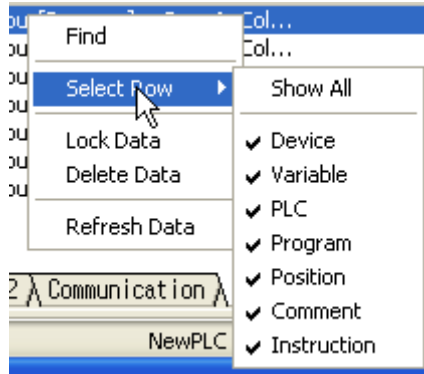

### 4) Lock Data

Details of the Cross Reference Window are updated when the cursor moves in the program. If you don't want to update them, specify the Fix function. Click the right mouse button to select [Lock Data].

### 5) Delete Data

It deletes all the details of the Cross Reference Window.

#### Notes

- It may take some time accordingly based on the number of devices used for aligning the data.

## 7.1.2 Output Cross Reference Instantly

If a device or variable is selected in the program, the used position and the application will be displayed.

[Steps]

1. Select the Cross Reference tap to display the Cross Reference Result on.
2. Move the cursor to the position of the device to display the purpose of.

## Chapter 7 Programming Convenience

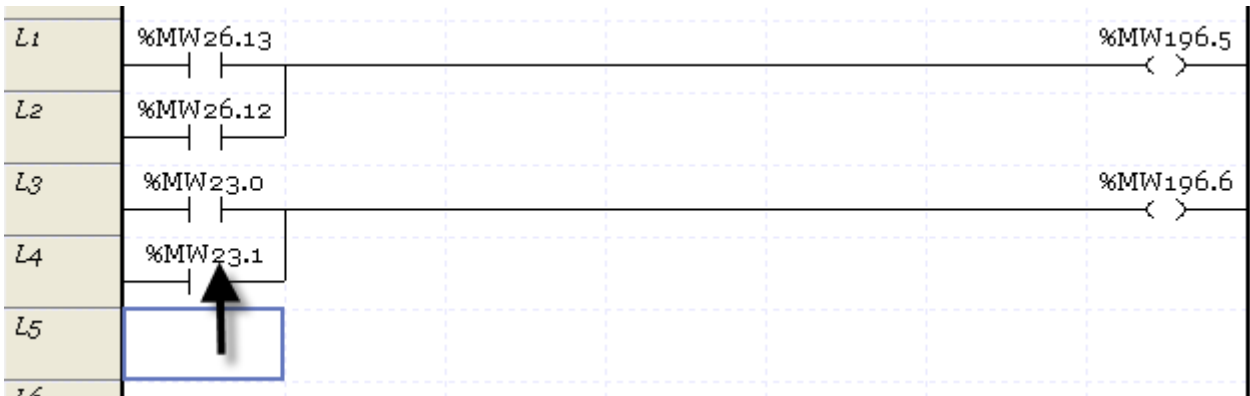

Device ...	Variable	PLC	Program	Position	Comment	Information
A1.0	SCAN_CNT	NewPLC	modbus[Program]	Row 6, Col...		- VAR -
A1.0	SCAN_CNT	NewPLC	modbus[Program]	Row 7, Col...		- VAR -
%QX0.0.1	C_ON	NewPLC	modbus[Program]	Row 0, Col...	INB_1comment	-(-)-
%MX1	INB_2	NewPLC	modbus[Program]	Row 0, Col...	C_ONcomment	- -
%MX0	INB_1	NewPLC	modbus[Program]	Row 0, Col...	INB_2comment	- -
	_STOG	NewPLC	modbus[Program]	Row 1, Col...	Every scan Toggle	- -
	_STOG	NewPLC	modbus[Program]	Row 5, Col...	Every scan Toggle	- -

Message Window: \Result \ Check Program \ Find 1 \ Find 2 \ Communication \ Cross Reference \ Used Device \ Duplicate Coil /

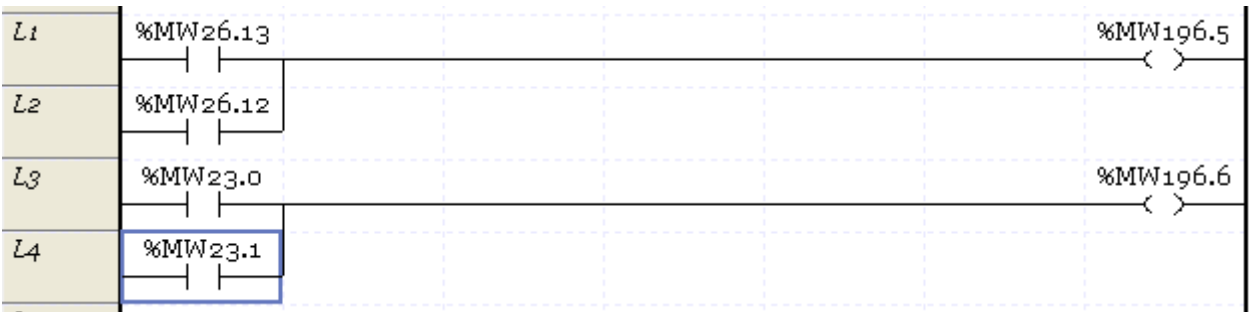

Device ...	Variable	PLC	Program	Position	Comment	Information
A1.0	SCAN_CNT	NewPLC	modbus[Program]	Row 6, Col...		- VAR -
A1.0	SCAN_CNT	NewPLC	modbus[Program]	Row 7, Col...		- VAR -
%QX0.0.1	C_ON	NewPLC	modbus[Program]	Row 0, Col...	INB_1comment	-(-)-
%MX1	INB_2	NewPLC	modbus[Program]	Row 0, Col...	C_ONcomment	- -
%MX0	INB_1	NewPLC	modbus[Program]	Row 0, Col...	INB_2comment	- -
	_STOG	NewPLC	modbus[Program]	Row 1, Col...	Every scan Toggle	- -
	_STOG	NewPLC	modbus[Program]	Row 5, Col...	Every scan Toggle	- -

Message Window: \Result \ Check Program \ Find 1 \ Find 2 \ Communication \ Cross Reference \ Used Device \ Duplicate Coil /

### Notes

- If 'Output cross reference instantly' is used, the edit speed may get slow.
- Select [Tools]-[Options]-[Edit Ladder/Mnemonic], on the Edit page to apply 'Output cross reference instantly' function.

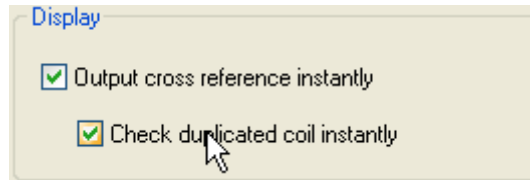

### 7.1.3 Check Duplicated Coil Instantly

It is used to inspect the applicable device or variable if used as duplicated whenever the coil is edited. If the device is used as a coil in a different location inside PLC, the list for the program name, location and step will be displayed.

#### [Steps]

1. Add a coil.

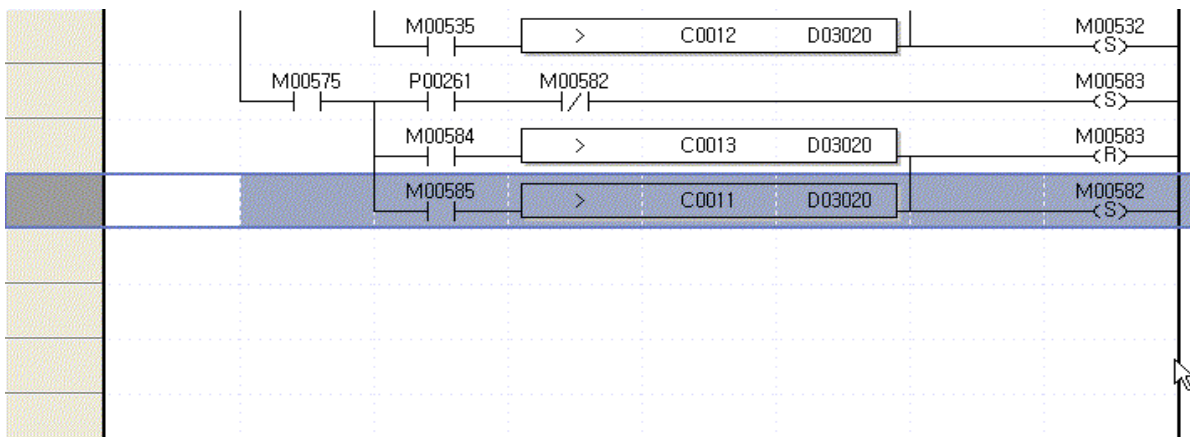

## Chapter 7 Programming Convenience

- Select and copy the line the applicable coil is included in to move to the next line to paste on.

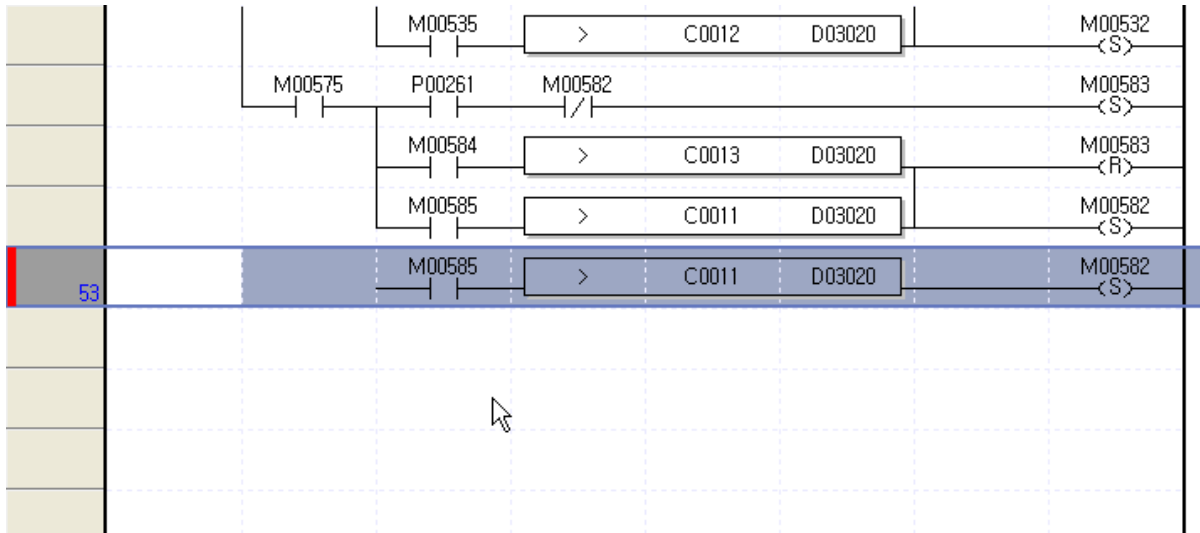

Device ...	Variable	PLC	Program	Position	Comment	Information
A1.0	SCAN_CNT	NewPLC	modbus[Program]	Row 6, Col...		- VAR -
A1.0	SCAN_CNT	NewPLC	modbus[Program]	Row 7, Col...		- VAR -
%QX0.0.1	C_ON	NewPLC	modbus[Program]	Row 0, Col...	INB_1comment	- -
%MX1	INB_2	NewPLC	modbus[Program]	Row 0, Col...	C_ONcomment	- -
%MX0	INB_1	NewPLC	modbus[Program]	Row 0, Col...	INB_2comment	- -
	_STOG	NewPLC	modbus[Program]	Row 1, Col...	Every scan Toggle	- -
	_STOG	NewPLC	modbus[Program]	Row 5, Col...	Every scan Toggle	- -

Message Window

Result | Check Program | Find 1 | Find 2 | Communication | Cross Reference | Used Device | Duplicate Coil

### Notes

- ‘If ‘Check duplicated coil instantly’ is used, the edit speed may get slow.
- Select [Tools]-[Options]-[Edit Ladder/Mnemonic], on the Edit page to apply ‘Check duplicated coil instantly’ function.

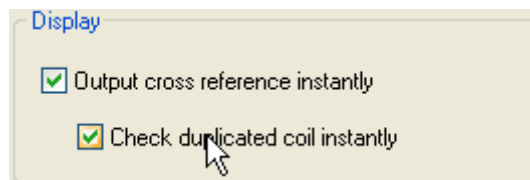

- ‘Check duplicated coil instantly’ inspects the coil and the reverse coil, positive conversion detection coil and negative conversion detection coil only.

## 7.2 Used Device

It shows all the devices and the number used in the program (LD, SFC). The devices used in each device area according to the designated types will be displayed as classified into input and output.

[Description of Window]

	WORD	15	14	13	12	11	10	9	8	7	6	5	4	3	2	1	0	
a	I	O	I	O	I	O	I	O	I	O	I	O	I	O	I	O	I	O
f	%MW00000									1								
	%MW00002	1											1				1	

- Device Display: displays each device used in the program.
- Word Column: used to display the number of the applicable device types used in the program. The column displays the number in accordance with the device type designated when executing the device used.
- Bit Column: used to display the number of the applicable bit devices used in the program. The devices of S area, T area and C area are displayed. The column displays the devices of the types smaller than these designated when executing the used device in bit type. Therefore, if designating word type, it displays the bit only. If the column designates 16 data types, 8 columns are created.
- I/O classification: used to display the number of the applicable bit devices as classified into input(I) and output(O).
- It displays there is 1 device using the 5th bit of %MW1 as the output.
- It displays there is 1 device using %MW2 as the input.

### 7.2.1 Execute Used Device

[Steps]

- Select [View]-[Used Device] on the menu.
- Select a desirable device on the Used Device selection dialog box.

[Dialog Box]

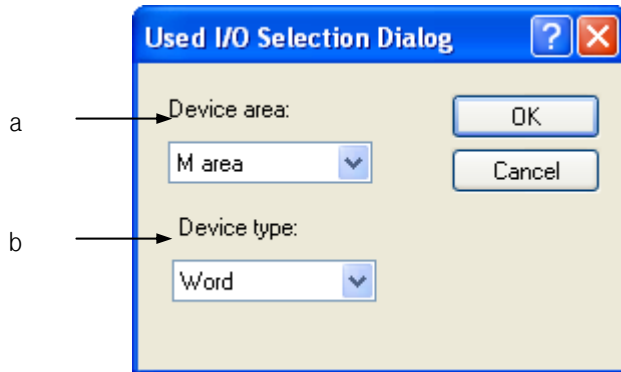

[Description of Dialog Box]

- a. Device Area Selection: selects a device area. The available areas are All, I area, Q area, M area, R area and W area.
- b. Device Type Selection: selects a device type. Bit, Byte, Word, Double word and Long word can be selected.

### Notes

- Select [Update Used Device] on the context menu to display the used devices
- After Used Device is executed, if you edit the program, the content of the Used Device is not updated automatically. If you want to see the Used Device of edited program, select [Update Used Device] again.

### 7.2.2 View Device Uses

Double-click the mouse on the cell where the used I/O figures are displayed, or click 'View Device Uses' on the context menu.

[Dialog Box]

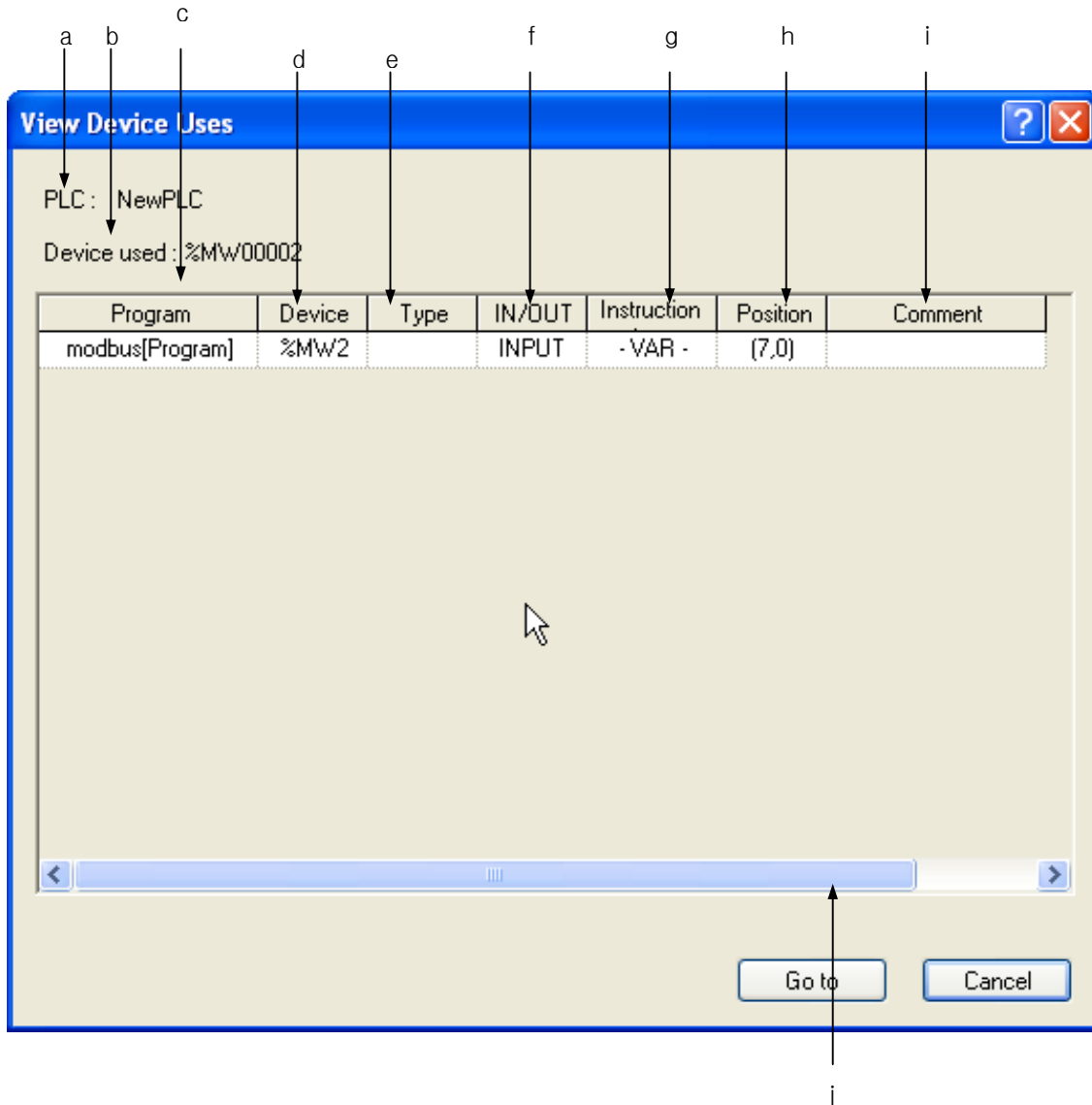

[Description of Dialog Box]

- a. PLC: used to display the PLC name with the applicable device used.
- b. Device: It is the device that the Device Uses View dialog box shows.
- c. Program: displays the program name with the applicable device used
- d. Device: displays the name of a device used in the program.
- e. Type: displays the device type used in the program.
- f. IN/OUT: displays whether the device is used as Input or Output.
- g. Instruction Type: shows for which instruction type of operand the applicable device is used. (displayed as identical as the instruction tool bar of LD editor).
- h. Position: displays the position in the program.
- i. Comment: displays the comment of a selected device.
- j. Go To: the function going to the program using the device of a selected line.

## 7.3 Check Program

This function is used to check the prepared LD program for errors. Inspection items are as follows;

- Logic Error: checks for LD connection errors.
- Grammar Error: checks for errors related with grammar used in SBRT/CALL, FOR/NEXT, etc.
- Duplicated Coil Error: checks for errors if output factors are used as duplicated.

### 7.3.1 Check Program Setting

[Steps]

1. Select [View]-[Check Program] on the menu.

[Dialog Box]

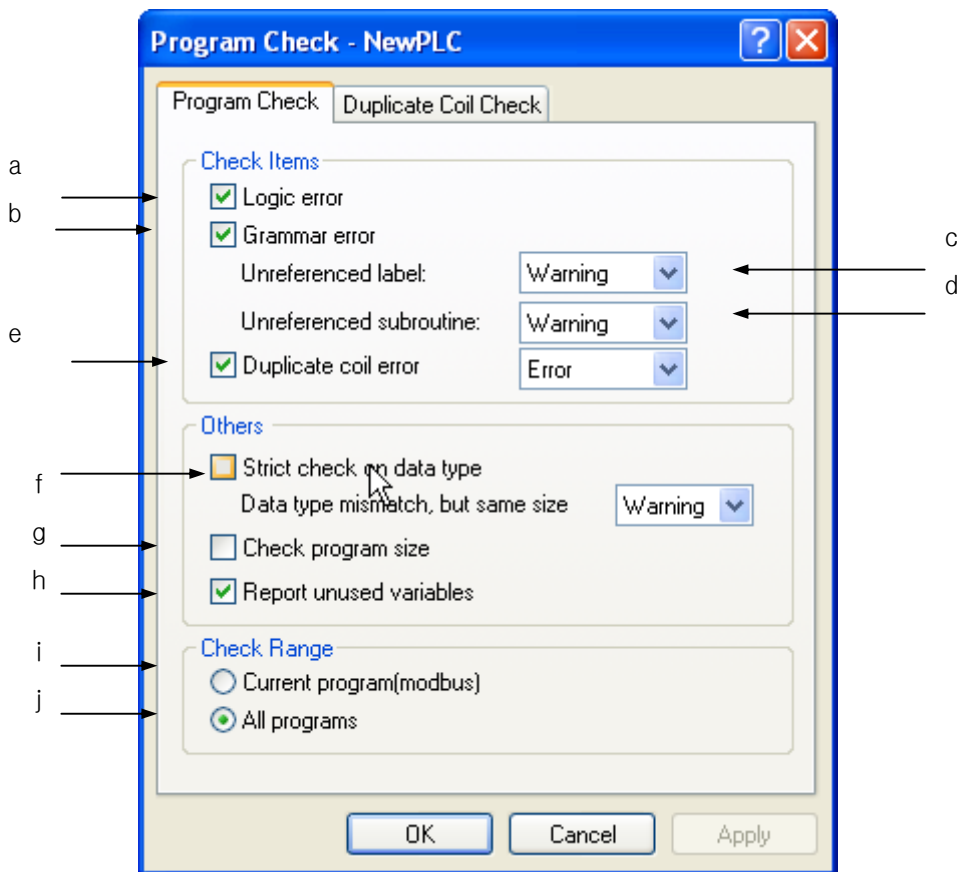



### [Description of Dialog Box]

- a. Logic Error: used to check for program's logic errors such as LD connection errors and short circuit.
- b. Grammar Error: used to check for errors in application instructions such as CALL/SBRT, MCS/MCSCLR, etc.
- c. Unreferenced label: used to specify the processing range of the declared label which was not used. [Ignore], [Warning] or [Error] can be selected.

### Notes

- Ignore: used not to check for any error.
- Warning: If any error occurs, [Warning] will be displayed on the Result Window and writing a program on PLC is available.
- Error: If any error occurs, [Error] will be displayed on the Result Window and writing a program on PLC is unavailable.

- d. Unreferenced subroutine: used to specify the processing range of the declared subroutine which was not used. [Ignore], [Warning] or [Error] can be selected.
- e. Duplicated coil error: used to check for the Duplicated Coil error, used to select [Error] or [Warning] for the Duplicated Coi.
- f. Strict check on data type: If it is not checked, it checks only the size of input/output parameter of function (function block).
- g. Check program size: displays program capacity information when checking.
- h. Report unused variables: displays unused variables in program.
- i. Current program (modbus): used to inspect the present program only.
- j. All programs: used to inspect all the programs listed on the present PLC item.

### Notes

- Refer to 7.3.3 and 7.3.4 for details on Logic Error and Grammar Error.
- If the present program only is selected while one or more programs are listed on the present PLC item, inspection of CALL/SBRT will not be executed.
- When writing a program on PLC, all the items except the Duplicated Coil will be always inspected if specified or not by the user.

## Chapter 7 Programming Convenience

### Notes

- In XGI series PLC, many programs can be added to the PLC item and the SBRT call is available between programs.

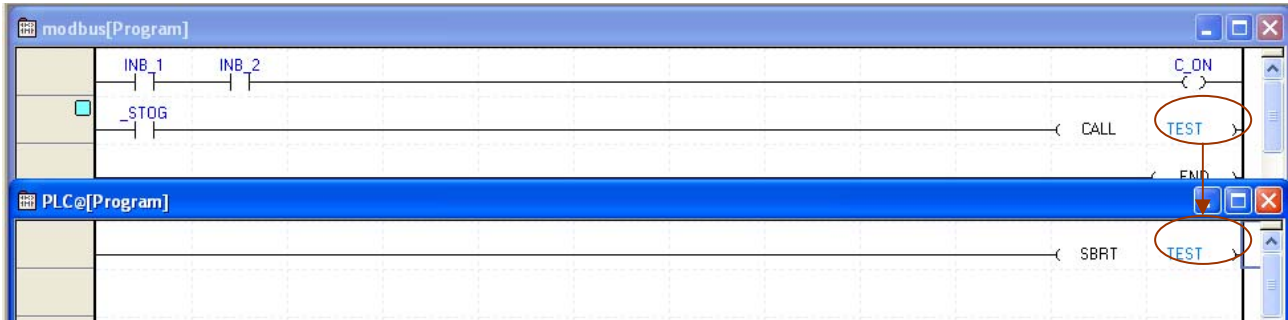

[Dialog Box]

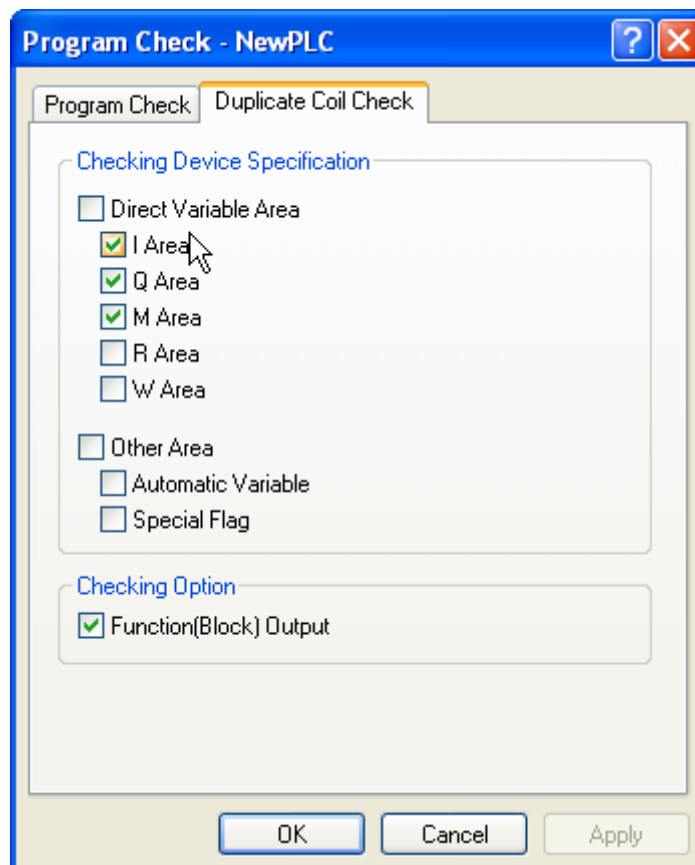

### [Description of Dialog Box]

- Checking Device Specification: sets the device and variable area to check.
- Checking Option: designates whether to check duplicated coil for a function(block) output.
- OK: applies the setting and closes the dialog box.
- Cancel: closes the dialog box.

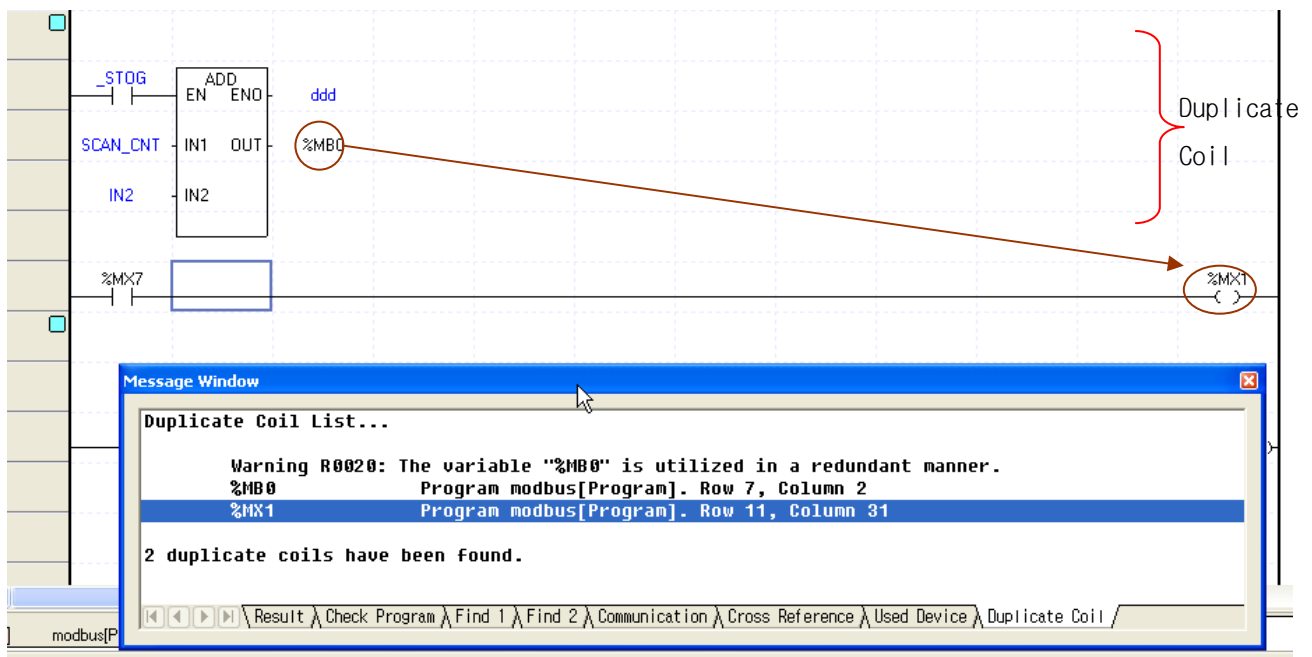

## Chapter 7 Programming Convenience

### Notes

- Set coil (-(S)-) and Reset coil (-(R)-) are not the object to check for the Duplicated Coil.
- In the Function(block) output check, the range is determined by the parameter type.

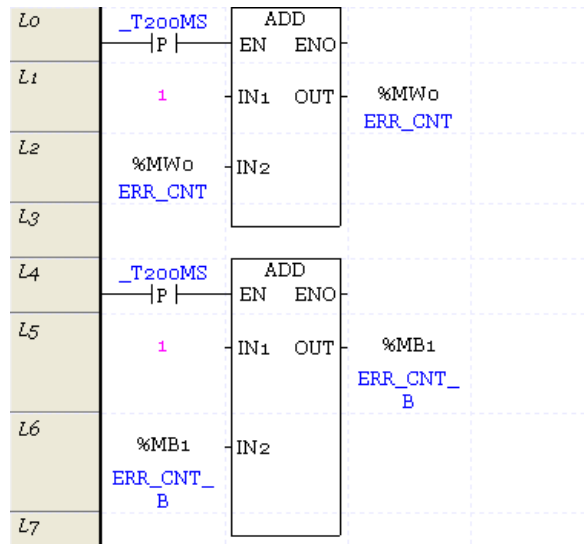

### 7.3.2 Check Result Trace

If any error occurs on the program, its details will be displayed on the Program Inspect tap of the message window. Double-click the error details to move to the location where the error occurs.

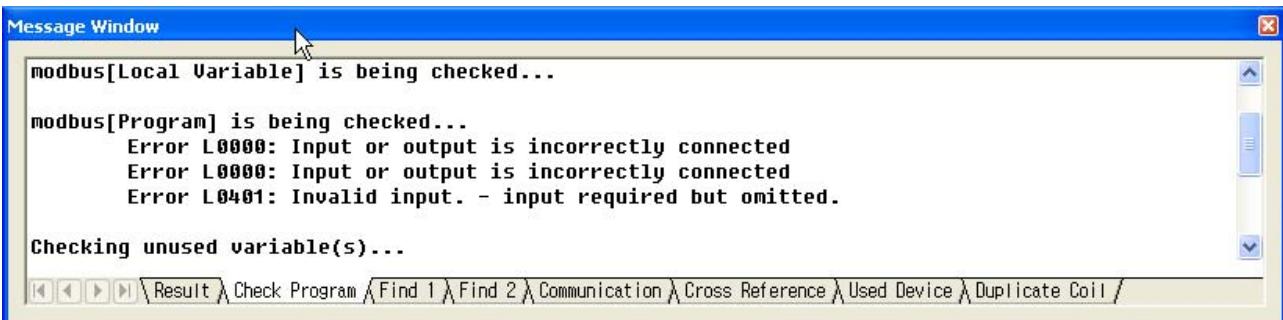
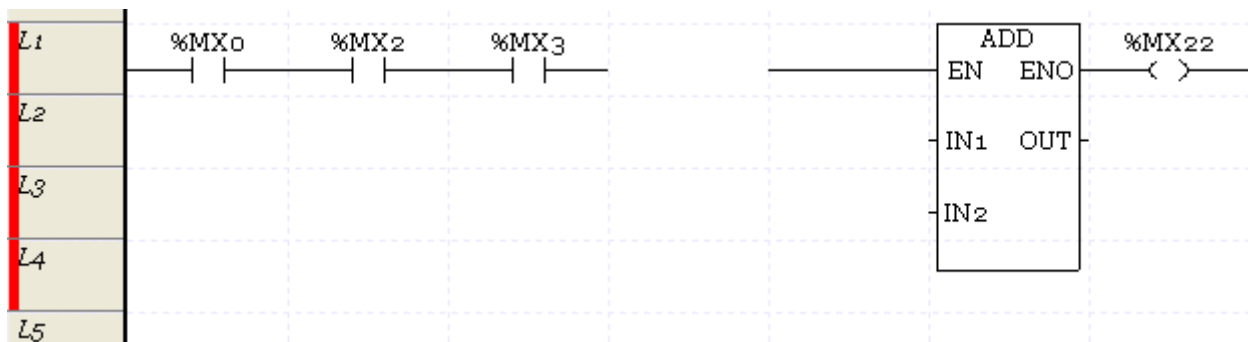

### 7.3.3 Logic Error

It is used to check for any logic error, and display its details and location if any occurs.

1) L0000: Input or output is not connected. This error will occur if the contact point is not connected with the power line.

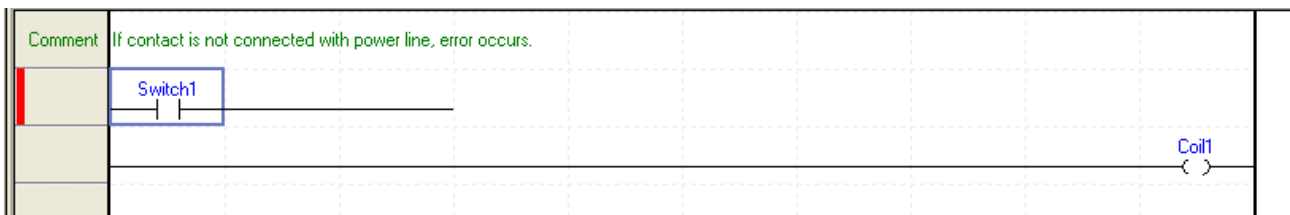

Action: Correct the LD program in order not to let input and output disconnect.

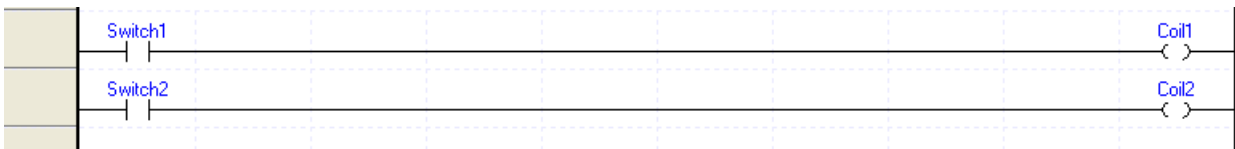

2) L0100: It is a short circuit. This error will occur if the area connected with OR is connected with the horizontal line without the contact point.

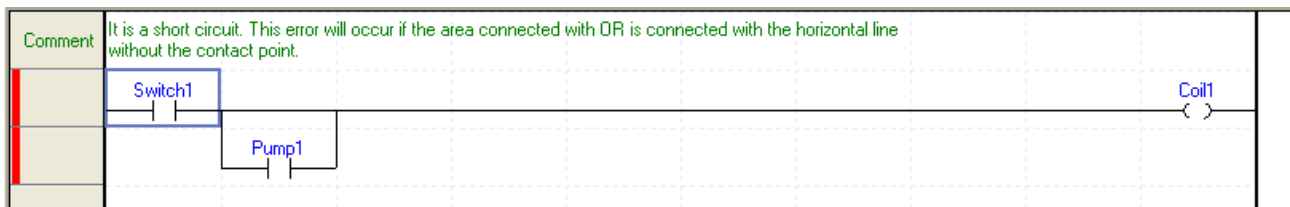

Action: Delete OR if the OR connection is not necessary any more, or input the contact point in the applicable location.

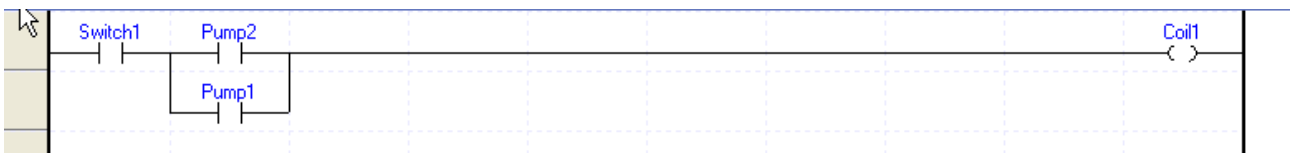

3) L0200: Device or variable is not input. This error will occur if the device or variable is not input in the contact point or coil.

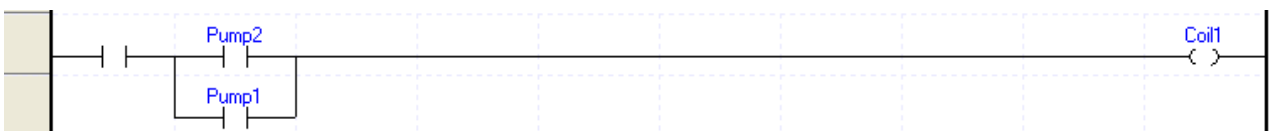

## Chapter 7 Programming Convenience

Action: Input a proper device in the contact point or coil where the error occurs.

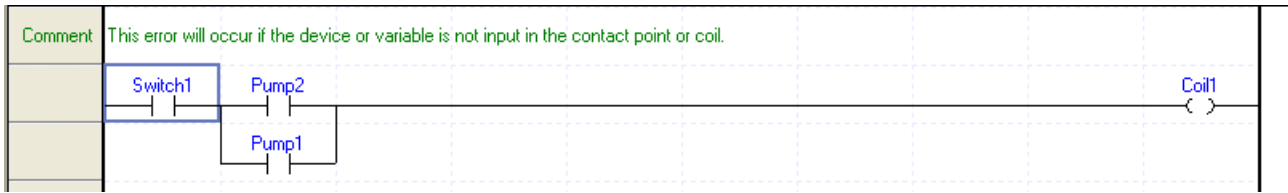

4) L0300: OR-LOAD incorrectly connected. This error will occur if OR-LOAD connected incorrectly.

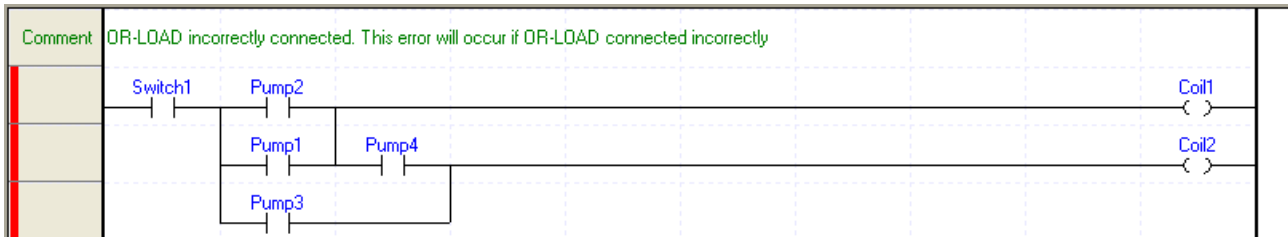

Action: Search for OR-LOAD incorrectly connected and then correct the LD program.

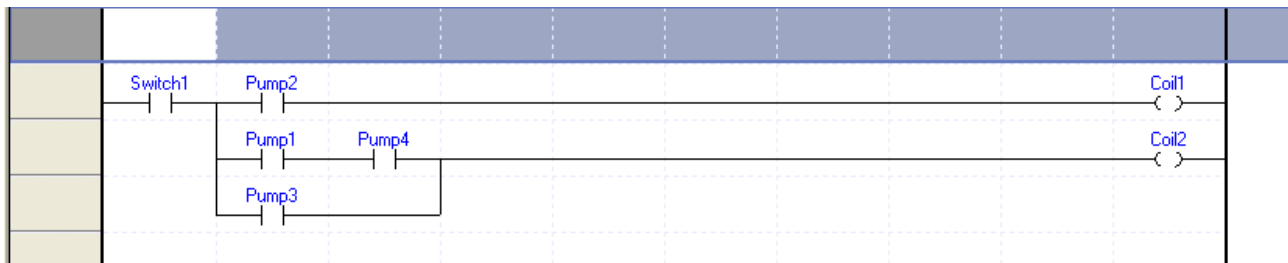

5) L0400: Specified number of contact points is exceeded. This error will occur if the number of continuous LOAD instructions exceeds 32.

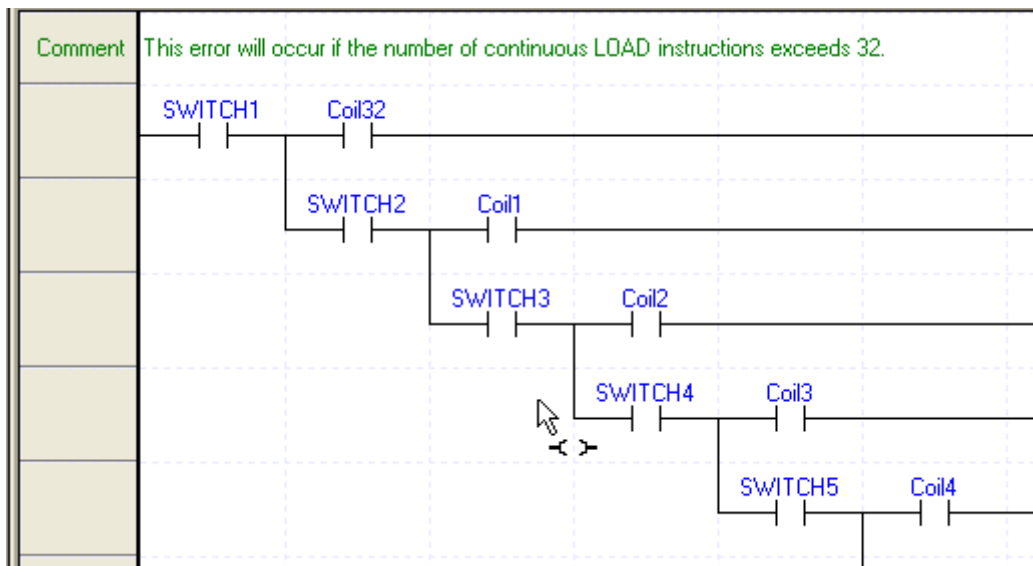

Action: Correct the LD program in order not to let the LOAD instructions exceed 32.

6) L0401: Incorrect input. This error will occur if the input necessary is nonexistent.

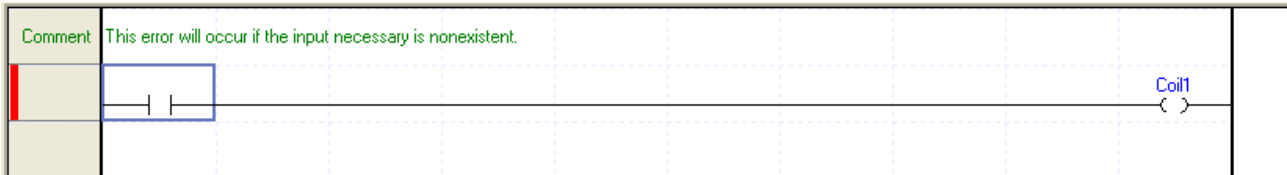

Action: Add the necessary input to the input terminal.

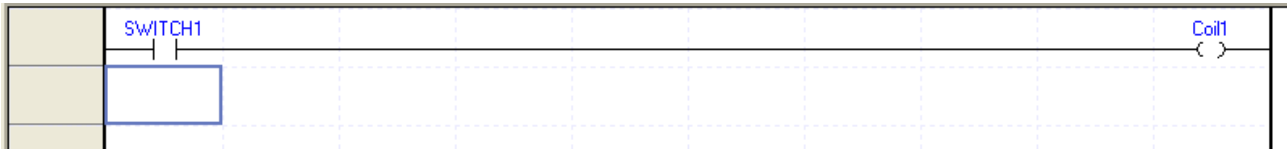

7) L0402: Incorrect input. This error will occur if the input unnecessary is existent.

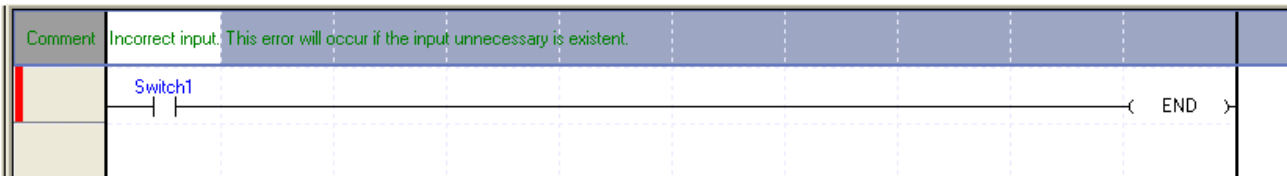

Action: Delete the input unnecessary from the input terminal.

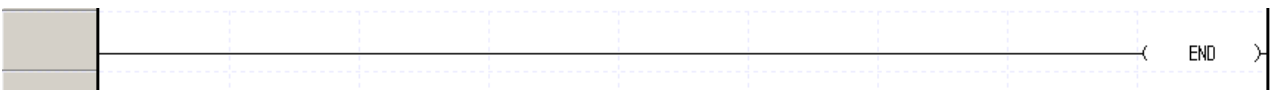

8) L0404: The maximum number of MPUSH exceeded. This error will occur if the number of continuous MPUSH/MPOP exceeds 16.

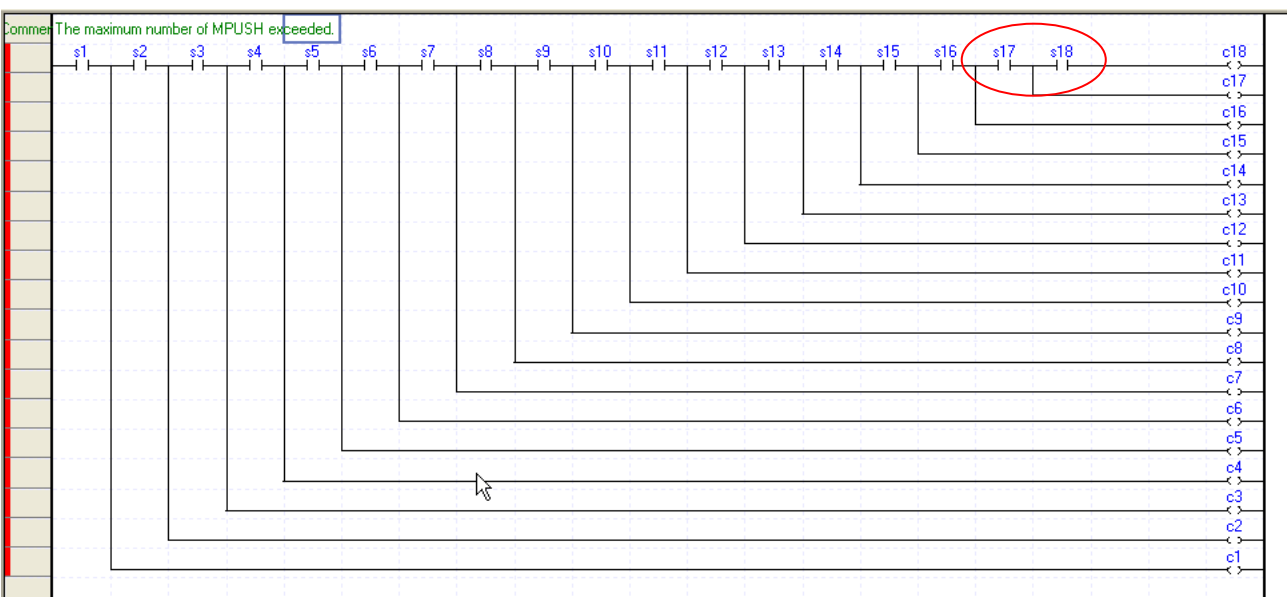

Action: Correct the LD program in order not to let the continuous MPUSH/MPOP exceed 16.

## Chapter 7 Programming Convenience

9) L0406: Application instruction in error. This error will occur if the application instruction nonexistent in XGI series PLC is used.

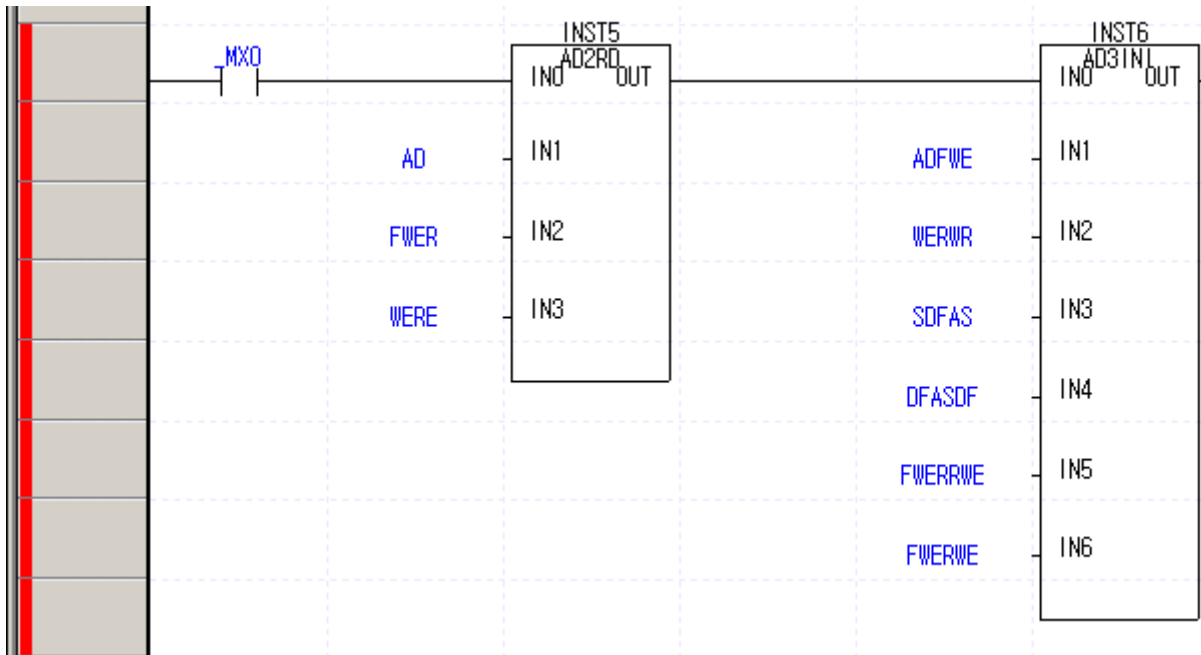
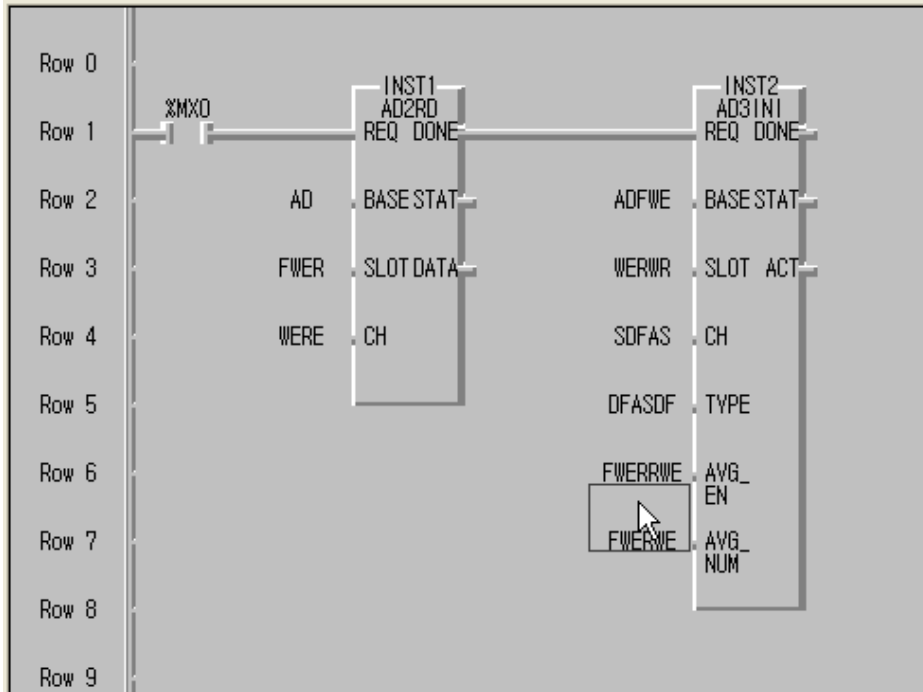

Action: Replace the instruction with the one provided by XGI series PLC.

### Notes

- This error will occur if GMWIN series PLC project file is converted to XGI project



### 7.3.4 Grammar Error

This function is used to check for grammar-related errors generated when a application instruction is used.

1) E1001: Label declared as duplicated. This error will occur if duplicated LABEL used.

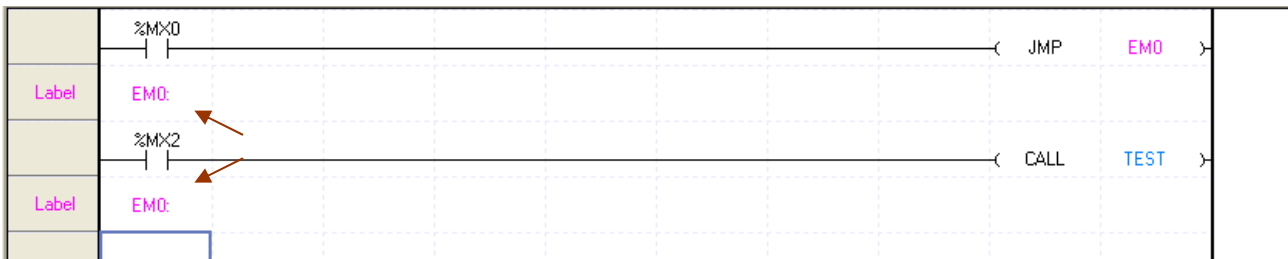

Action: Delete the duplicated label, or change the name of the label.

2) E1002: Label 'Label Name' nonexistent. This error will occur if JMP is used to refer to the nonexistent label.

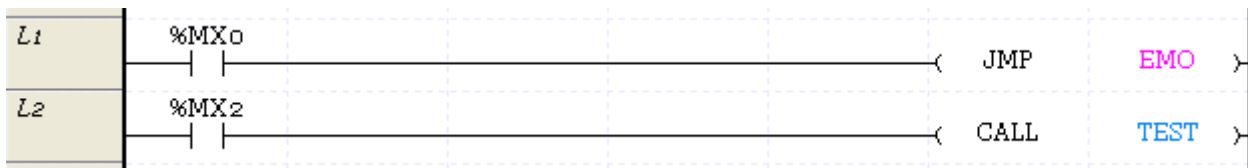

Action: Add the label where the error occurs, or correct the JMP instruction which uses the label.

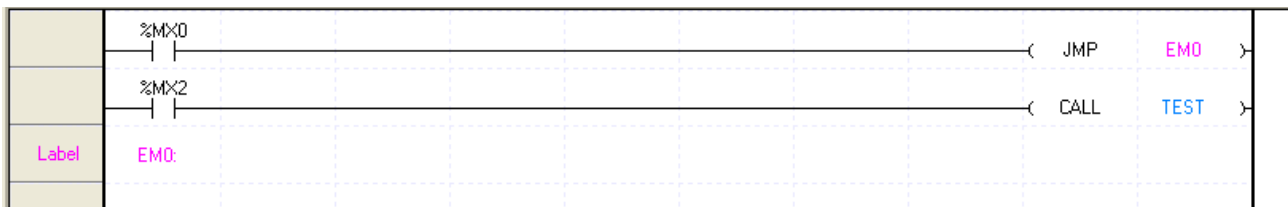

3) E1003: Label 'Label Name' not used. This error will occur if the JMP instruction is nonexistent to use the label existent.

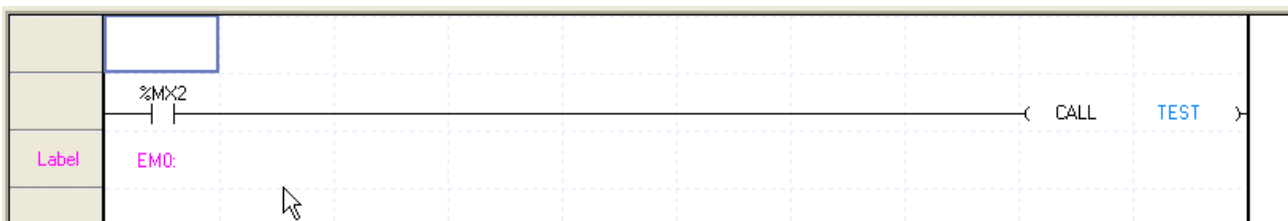

Action: Delete the label, or add the application JMP instruction.

## Chapter 7 Programming Convenience

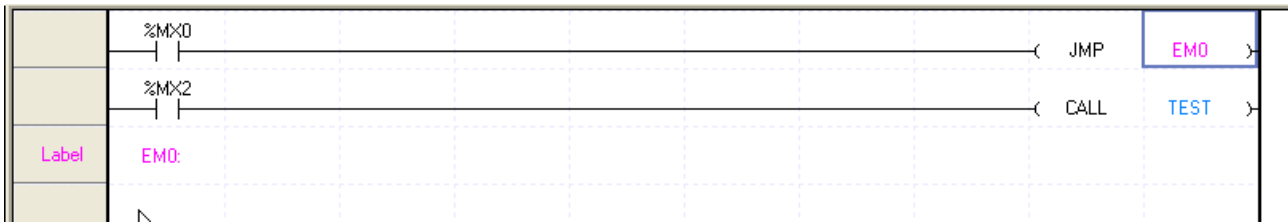

4) E1004: Label '*Label Name*' not used in the subroutine. This error will occur if the JMP instruction is nonexistent to use the label existent in the subroutine.

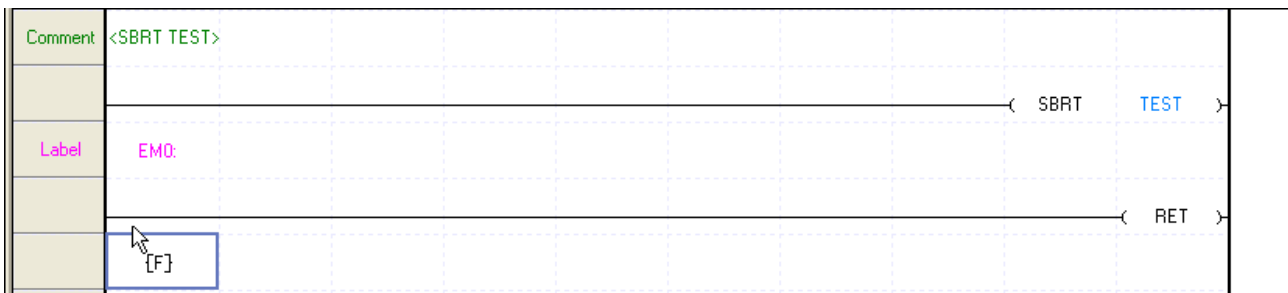

Action: Delete the label in the subroutine, or add the application JMP instruction.

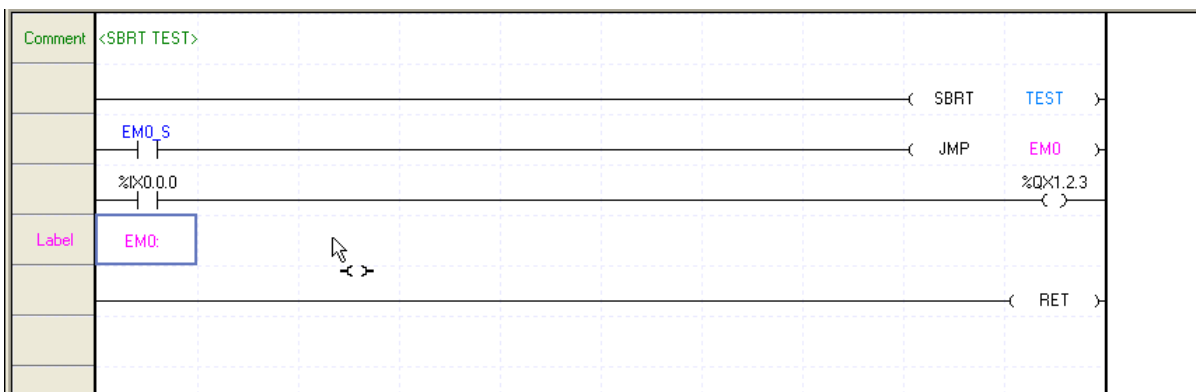

### Notes

- The error number E1003/E1004 will occur only when [Warning] or [Error] is selected for the label not referred to in the Grammar Error Inspect item. Refer to 7.3.1 Program Inspect Setting for details..

5) E1005: Label '*Label Name*' nonexistent in the subroutine. This error will occur if the JMP instruction uses the label nonexistent in the subroutine.

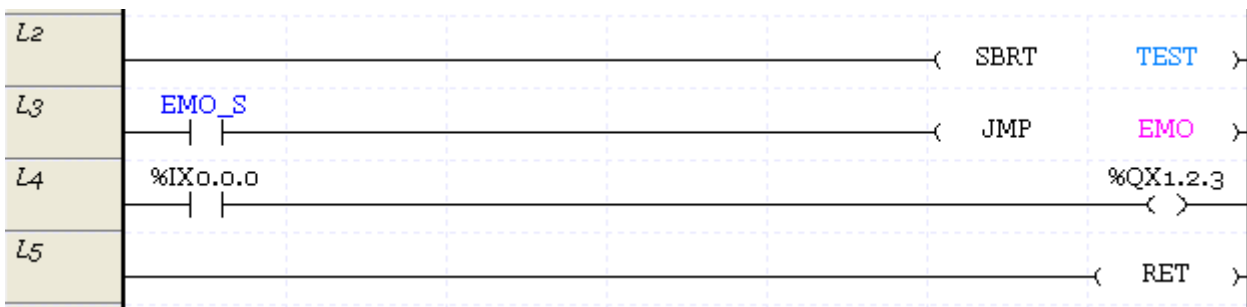

Action: Add the label in the subroutine, or correct the JMP instruction.

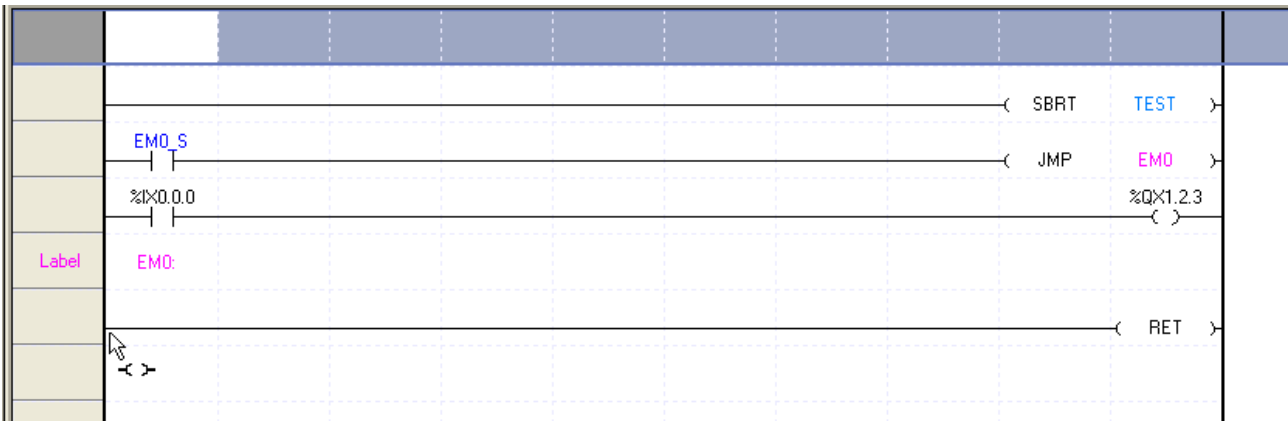

6) E2001: Return instruction nonexistent in the subroutine 'Subroutine Name'. The subroutine shall be finished with the RET instruction.

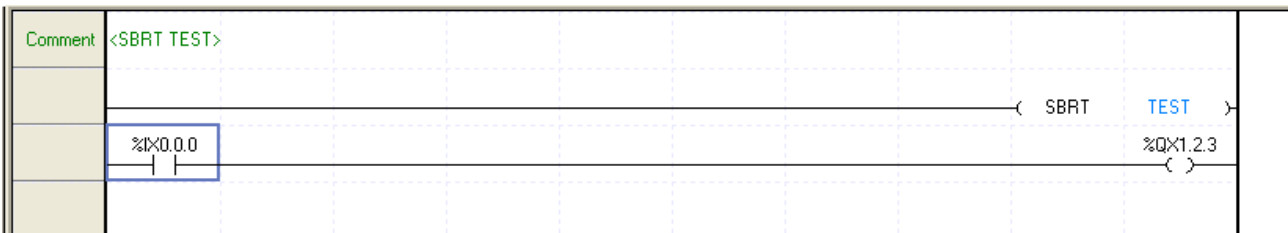

Action: Add the RET instruction in the subroutine block.

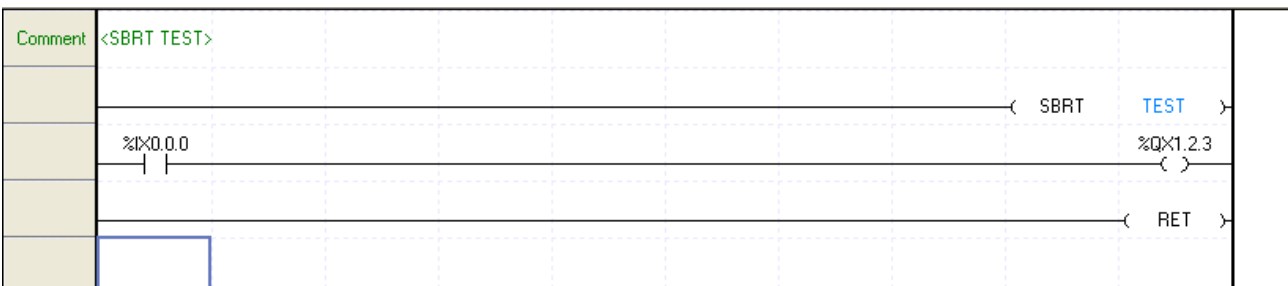

7) E2010: Subroutine call nonexistent. The call of nonexistent SBRT causes an error.

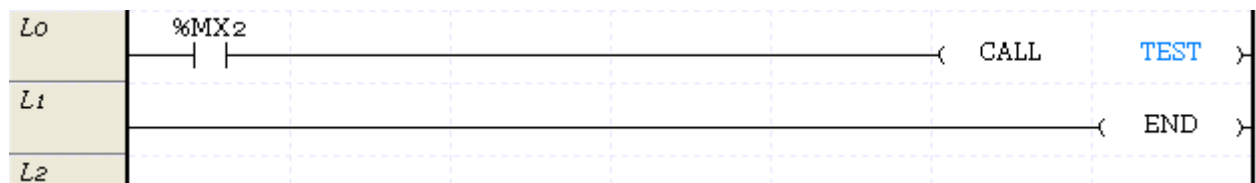

Action: Add the SBRT~RET blocks of the subroutine name to call.

## Chapter 7 Programming Convenience

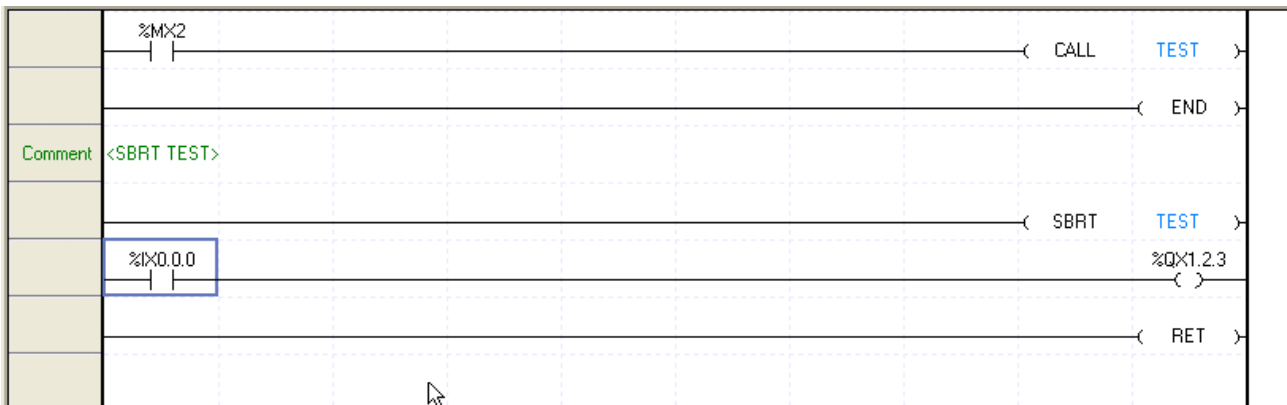

8) E2003: Subroutine '*Subroutine Name*' is positioned prior to END instruction. SBRT and RET positioned prior to END instruction cause an error.

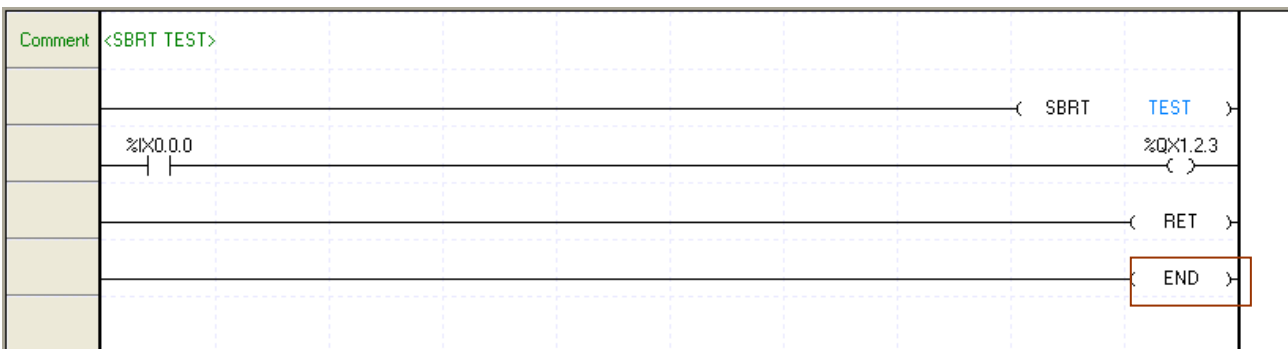

Action: Move the application instructions SBRT and RET to the position after the End instruction.

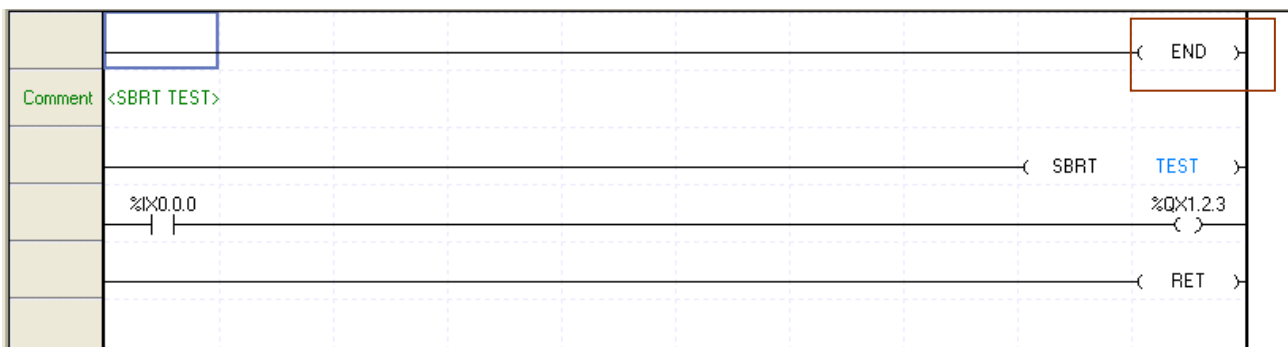

9) E2011: Subroutine not used. Although SBRT~RET blocks exist, no CALL instruction is available to use the applicable subroutine.

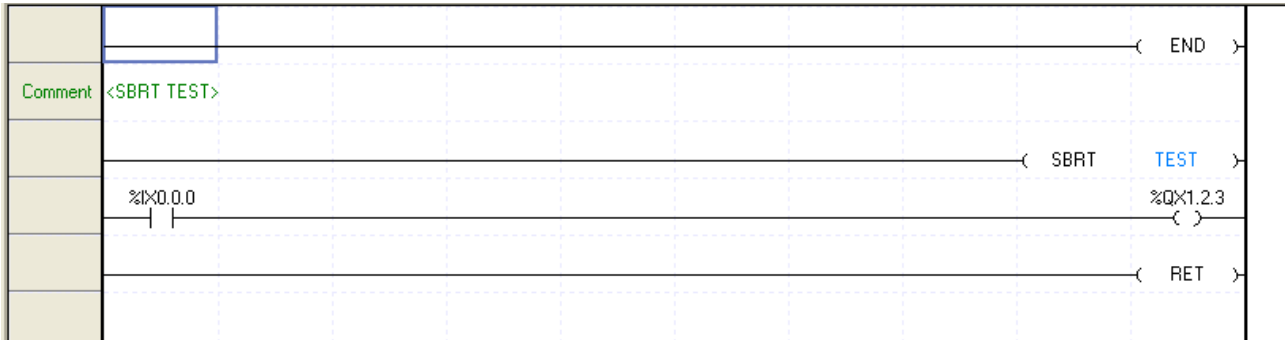

Action: Delete the subroutine not to be used, or add the CALL instruction.

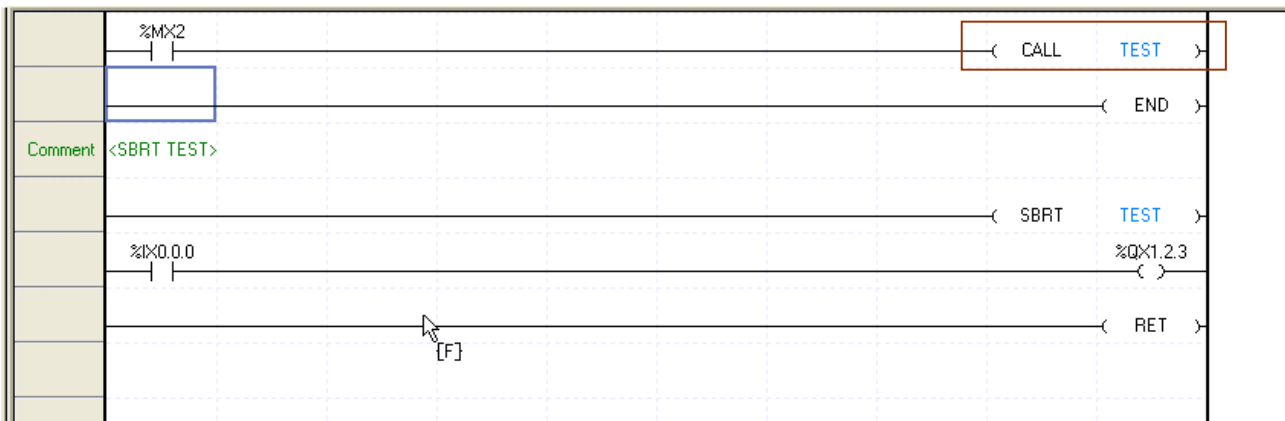

### Notes

- The error number E2011 will occur only when [Warning] or [Error] is selected for the subroutine not referred to in the Grammar Error Inspect item. Refer to 7.3.1 Program Inspect Setting for details.

10) E2012: Subroutine declared as duplicated. 'Subroutine Name'- An identical name of the subroutine can not be used.

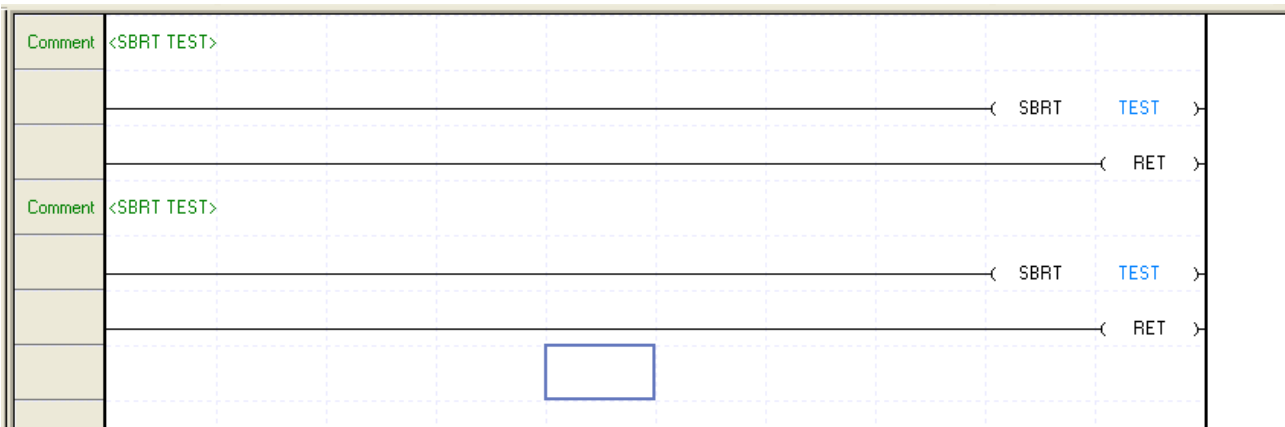

Action: Change the duplicated name of the subroutine.

## Chapter 7 Programming Convenience

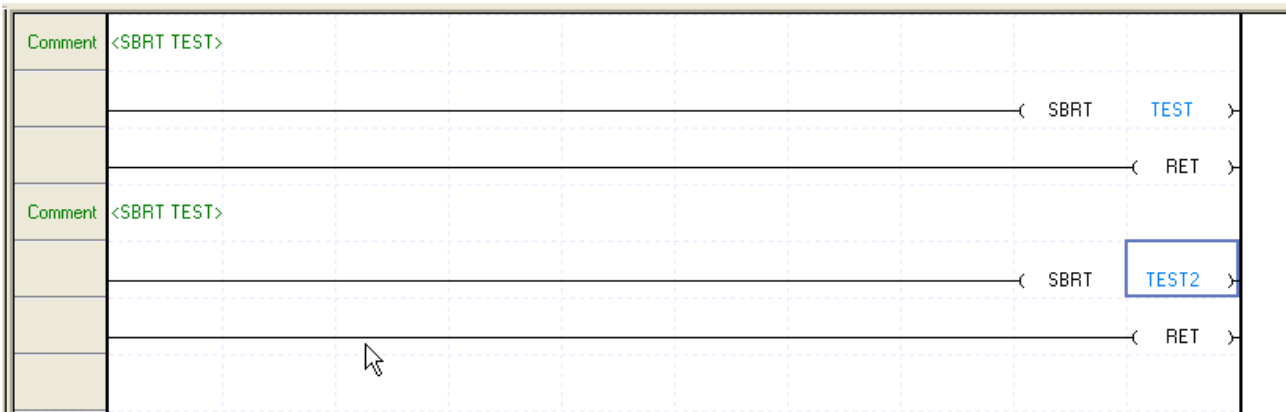

11) E2014: The maximum number of subroutines exceeded. Based on the PLC type, the maximum number of subroutines is exceeded.

Action: Check the number of the subroutines used.

### Notes

- The maximum number of subroutines usable depends on the PLC type. Refer to XGI CPU manual for details.

12) E3001: Identical NEXT unavailable. If the application times of FOR/NEXT instructions are not identical, it will cause an error.

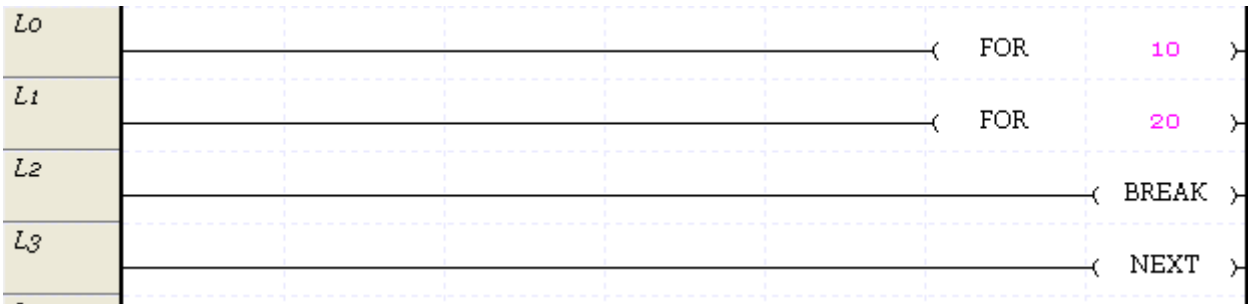

Action: Let the number of FOR instructions and NEXT instructions identical.

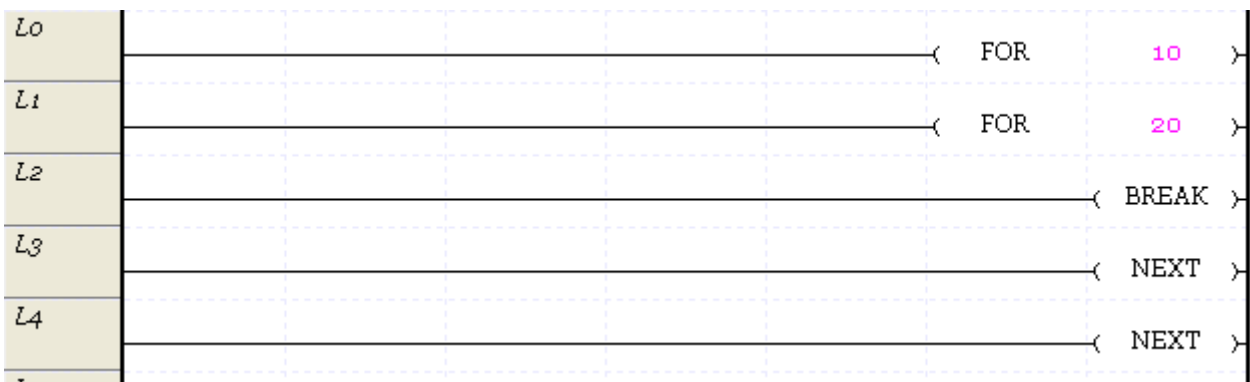

13) E3002: Identical FOR unavailable. If the application times of FOR/NEXT instructions are not identical, it will cause an error.

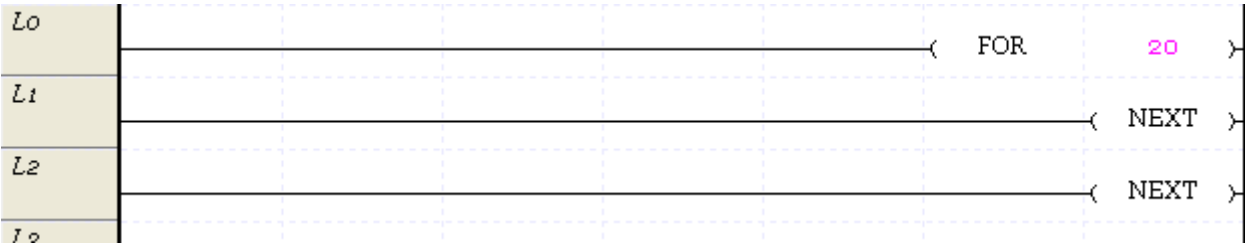

Action: Let the number of FOR instructions and NEXT instructions identical.

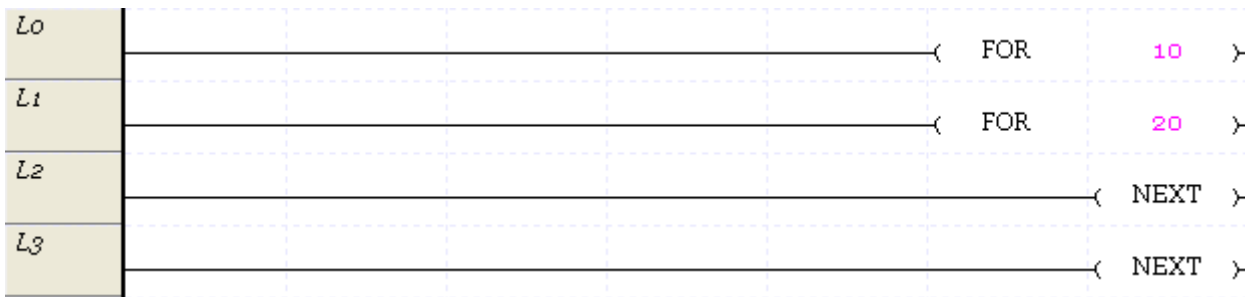

14) E3003: FOR-NEXT can not be duplicated more than 16 times. FOR/NEXT can be duplicated up to 16 blocks. If the number of the duplicated FOR/NEXT blocks exceeds 16, it will cause an error.

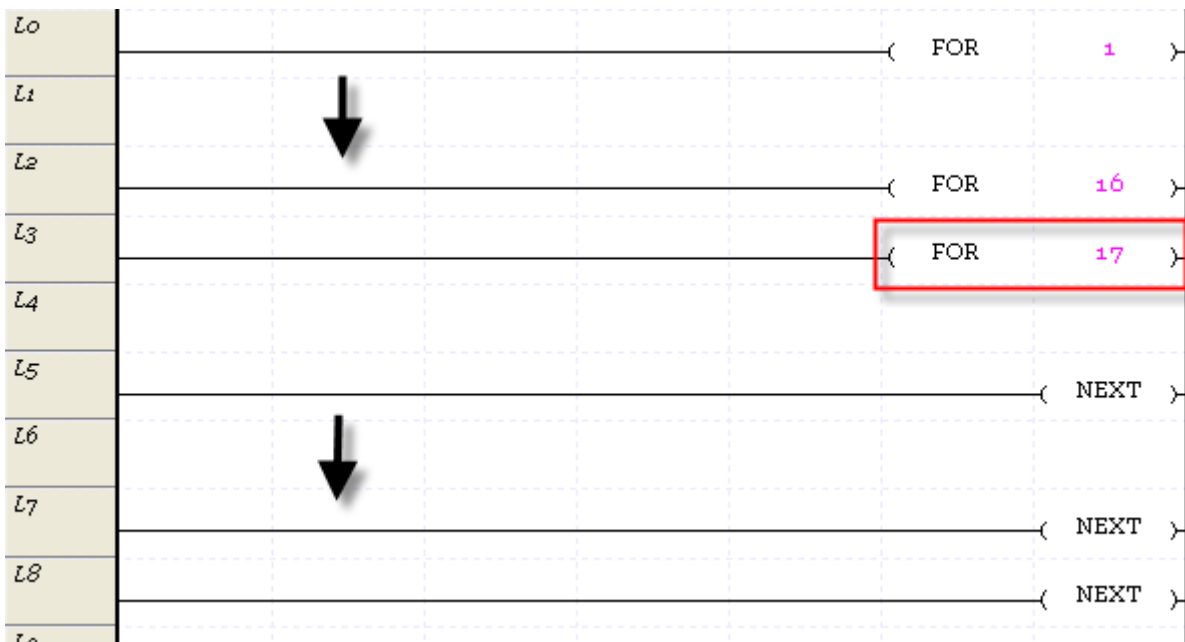

Action: Correct the number of the FOR / NEXT blocks not to exceed 16.

## Chapter 7 Programming Convenience

15) E3004: Between FOR-NEXT, RET or END is not available. If RET or END is included between FOR and NEXT, it will cause an error.

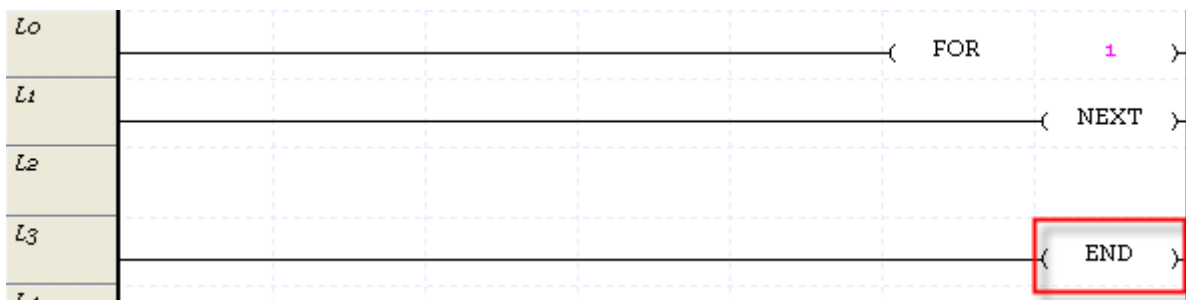
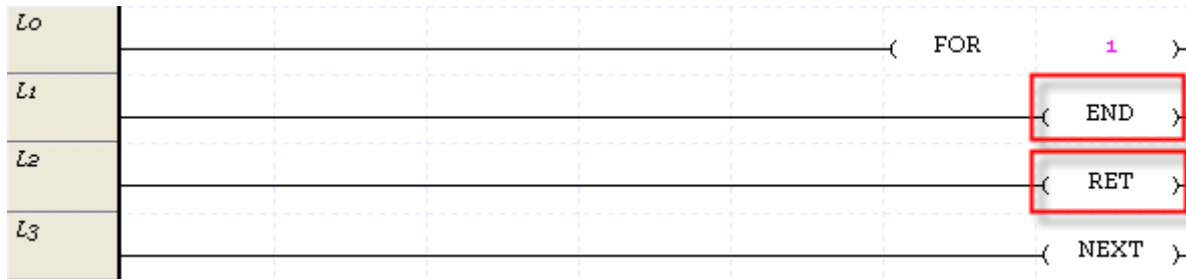

Action: Change the location of END and RET instruction positioned between FOR/NEXT blocks.

16) E3005: BREAK singly used. BREAK instruction can be used only between FOR/NEXT blocks.

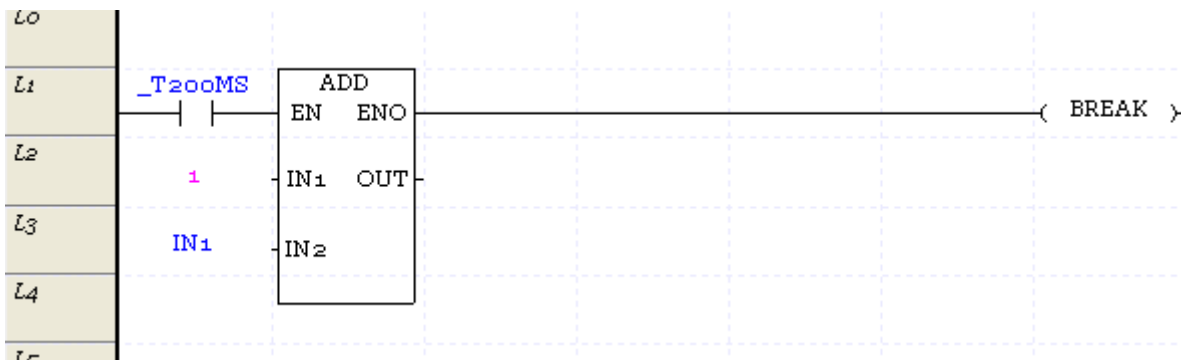

Action: Change the location of BREAK instruction.



17) 00002: needs one and more scan program. – There is no scan program in the present PLC item, which will cause an error.

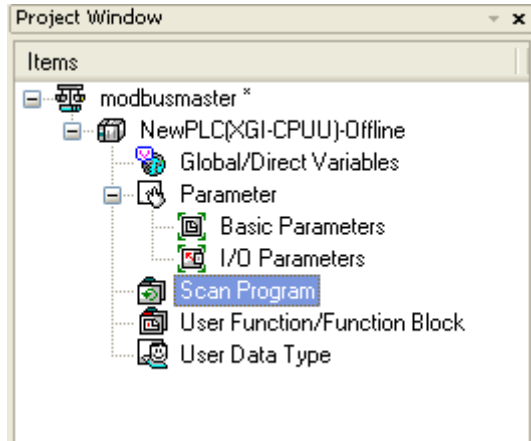

Action: add an applicable program item to the Project[Scan Program].

18) 00003: There is no program to check – There is no program in the present PLC item.

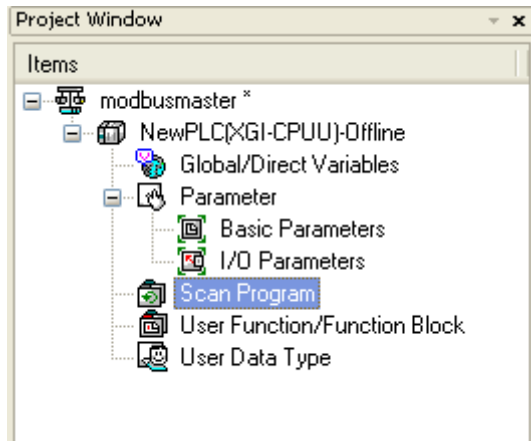

Action: add a scan program and try again.

19) E1300: An element(instruction) not available in UDF.

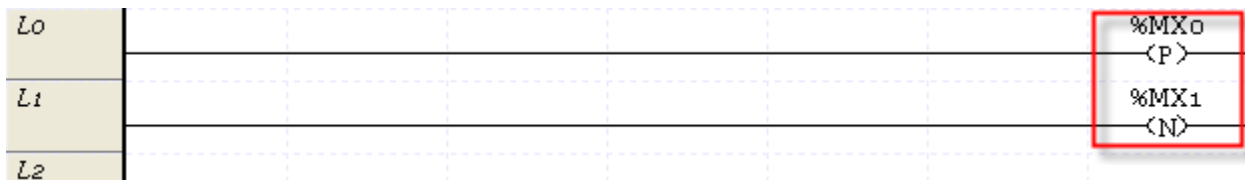

Action: the function block and positive (negative) detection contact point(coil) of which previous status should be memorized are not available in UDF. Delete them.

## Chapter 7 Programming Convenience

### Notes

-The elements can not be inserted in UDF Edit but they can be inserted by using Paste and other functions in other programs.

20) E1310: The return value needs, at least, one and more outputs.

Action: The VAR\_RETURN type variable is not designated in UDF, which causes an error. Check whether the variable is used in the program.

21) E1400: needs the TRANS output.

Action: TRANS variable is not designated as the output in the SFC Transition Program created by LD, which causes an error. Check whether the variable is used as output in the program.

22) E5000: Needs one or more INIT\_DONE instruction to end the initialization task.

Action: although the initialization task is added, the conditions to end the initialization task are not designated. In order to normally end the scan program, the conditions to end the initialization task should be designated.

23) L0700: Undeclared variable

Action: the variable used as the IO parameter of contact point, coil and function(Block) is not declared. Check whether the variable is declared in the local variable.

24) L0701: Input unsuitable data type.

Action: the type of used device or variable is not suitable. Check the type of used device or variable.

25) L0702: Invalid input connection

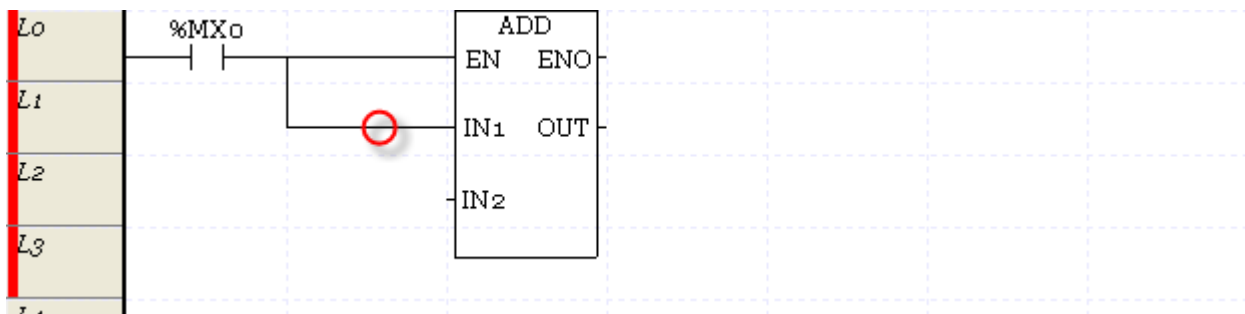

Action: the line connection of function (block) is only available for BOOL type. Since line can not be connected to other type but BOOL, check the line input.

26) L0703: Function(block) can not have input line more than 1.

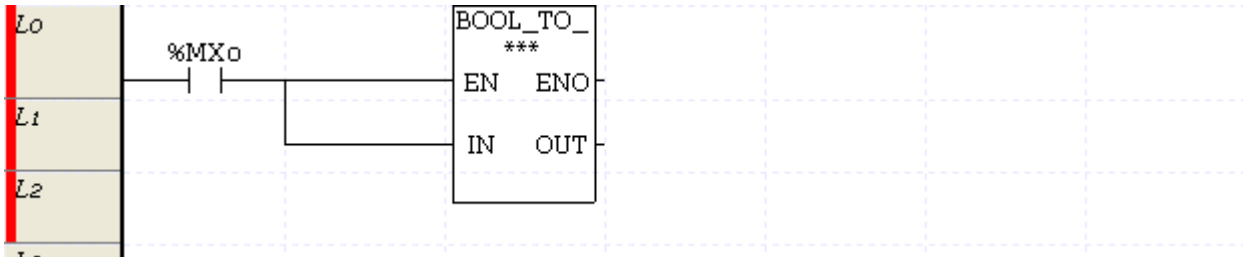

Action: Function(block) can not have input line more than 1. Check the line connection.

27) L0704: Invalid output connection

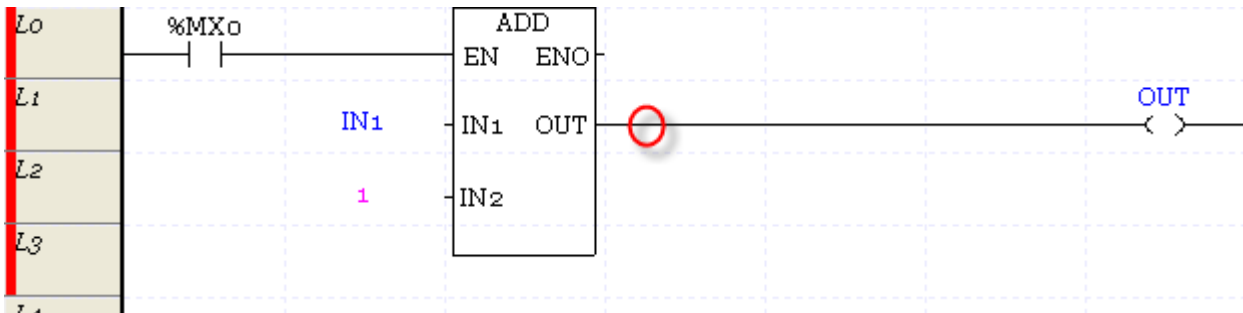

Action: the line connection of function(block) is only available for BOOL type. Since line can not be connected to other type but BOOL, check the line output.

28) L0705: Function (block) can not have output line more than 1.

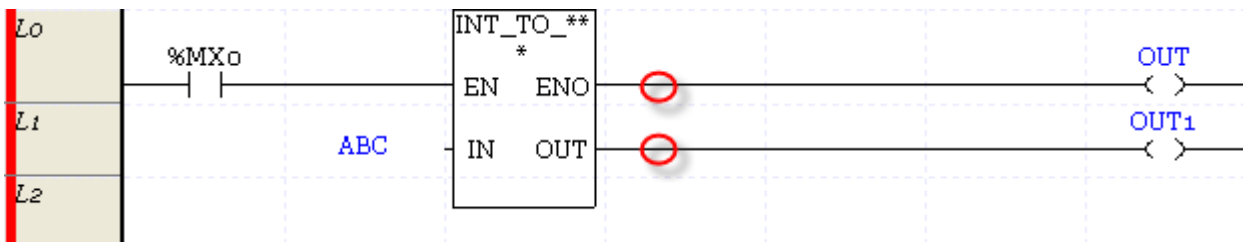

Action: Function (block) can not have output line more than 1. Check the line connection.

29) L0706: Incorrect function IO type

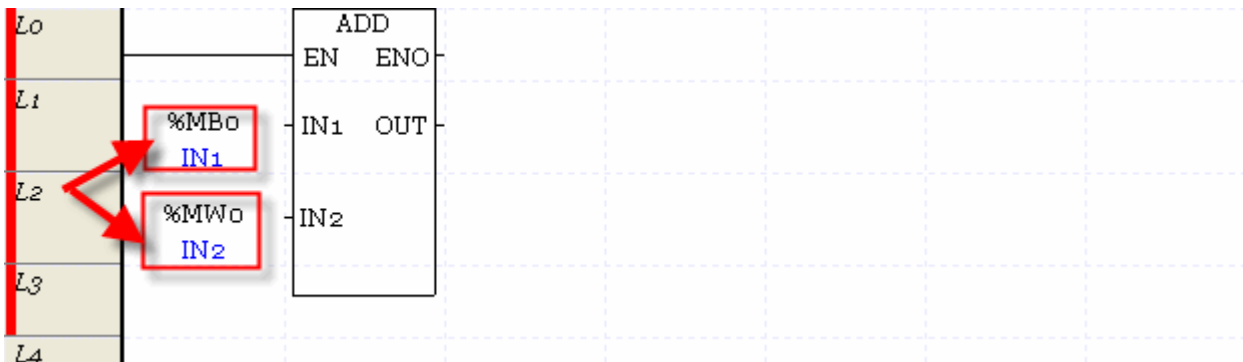

## Chapter 7 Programming Convenience

Action: in case of the function (block) having ANY type as the IO parameter, the data type of IO parameter indicated as ANY type should coincide. Check the data type of the input IO parameter.

### Notes

– If the strict data type check is not set in the program check options, it checks the only IO parameter size of function(block).

30) L0707: The size of array does not coincide.

Action: the size of array used in MOVE function as the IO parameter should coincide.

31) L0708: Unknown function.

Action: unavailable function. Check whether the function is user-defined function.

32) L0709: Instance name is omitted.

Action: the instance name is omitted in the function block. Check the input items.

33) L0710: Instance type does not coincide.

Action: the instance type of function block is not identical with the function block. Check the input items.

34) L0711: Undeclared instance

Action: the function block instance is not declared in the local variable. Declare the function block instance in the local variable before use.

## Chapter 8 Find/Replace

This is used to find or change the device and the String in LD, SFC and Variable/Comment of XG5000

### 8.1 Find Device

This function is used to find the device previously made in LD Editor, SFC Editor, or Variable/Comment Editor

[Dialog Box]

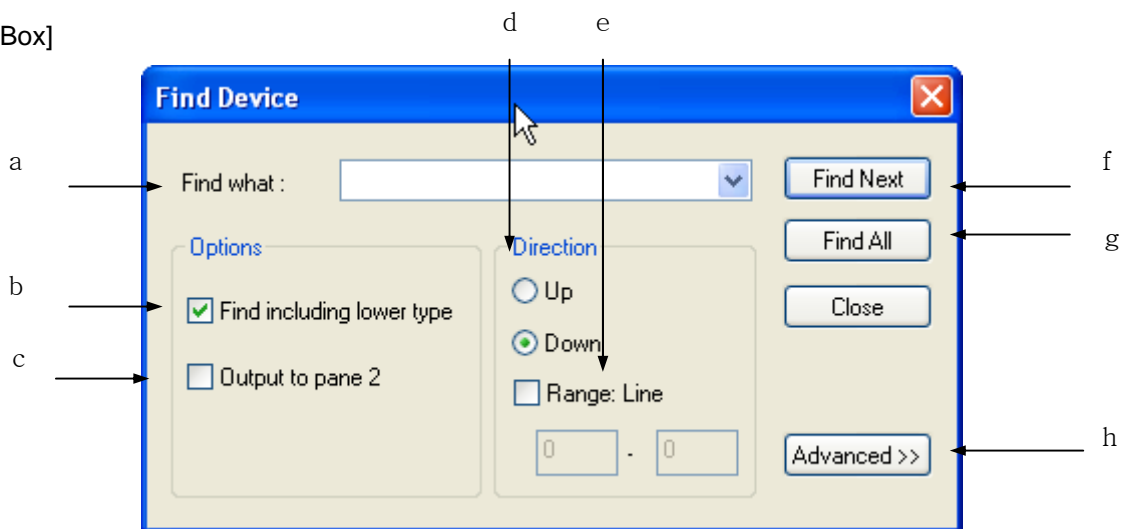

[Description of Dialog Box]

- Find what: used to specify the device to find.
- Find including lower type: used to select the device type containing the device to find. Then, if checking the checkbox, it finds %IB0.1.0, %IW0.1.0, %IL0.1.0 and others containing %IX0.1.1.
- Output to pane 2: XG5000 has two Find result windows. Basically the result is yielded to Find 1 result window, but if this check box is selected, the result will be yielded to Find 2 result windows.
- Direction: used to specify the location to find upward or downward from the line presently selected in the respective editor.
- Range: selects it to find by designating a specific line after designating the direction. If Range is selected, the start and end lines should be also entered.
- Find Next: finds the detail specified above right in the next to the line (position) presently selected. If the applicable device is found, the position the applicable device is located will be selected.
- Find All: finds all the details specified above to display the result on the find result window.
- Advanced>>: It is only used in LD editor. 'Advanced>>' and 'Advanced<<' is changed by click. It is used to find specific contact point, specific coil and extended function and function/function block used in LD editor

## Chapter 8 Find/Replace

### Notes

- The result will be displayed on the find window only with Find All executed.
- Since Find All finds all details in the applicable documents, it is insignificant to select the direction.
- Advanced>> is displayed only in Ladder editor.
- Advanced>> (extension) and Advanced<< (shrink) is as shown below.

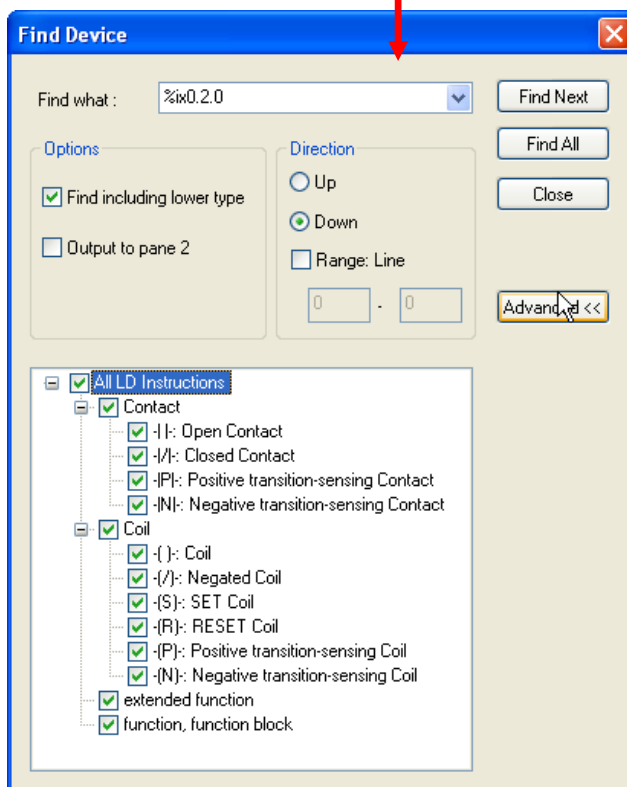
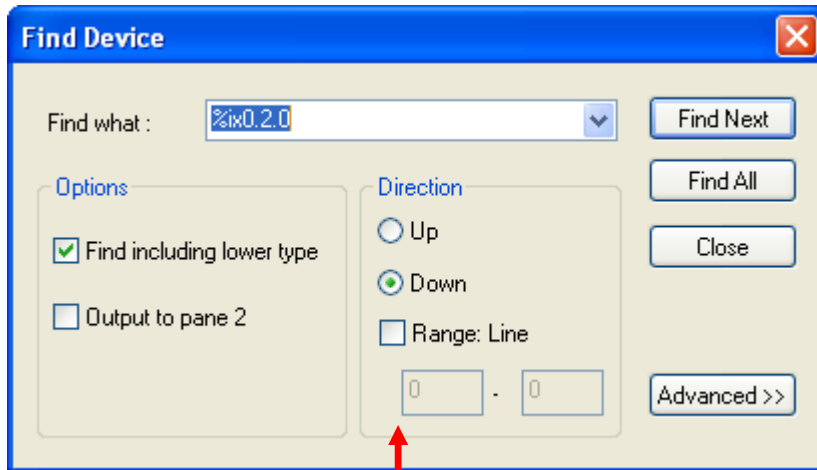

### 8.1.1 Find Next Device

It is used for LD, SFC, IL, Global/Direct Variable, Variable and Local Variable in common. Details of this function will be described below based on LD.

[Steps]

1. Select the basic cell of the direction.

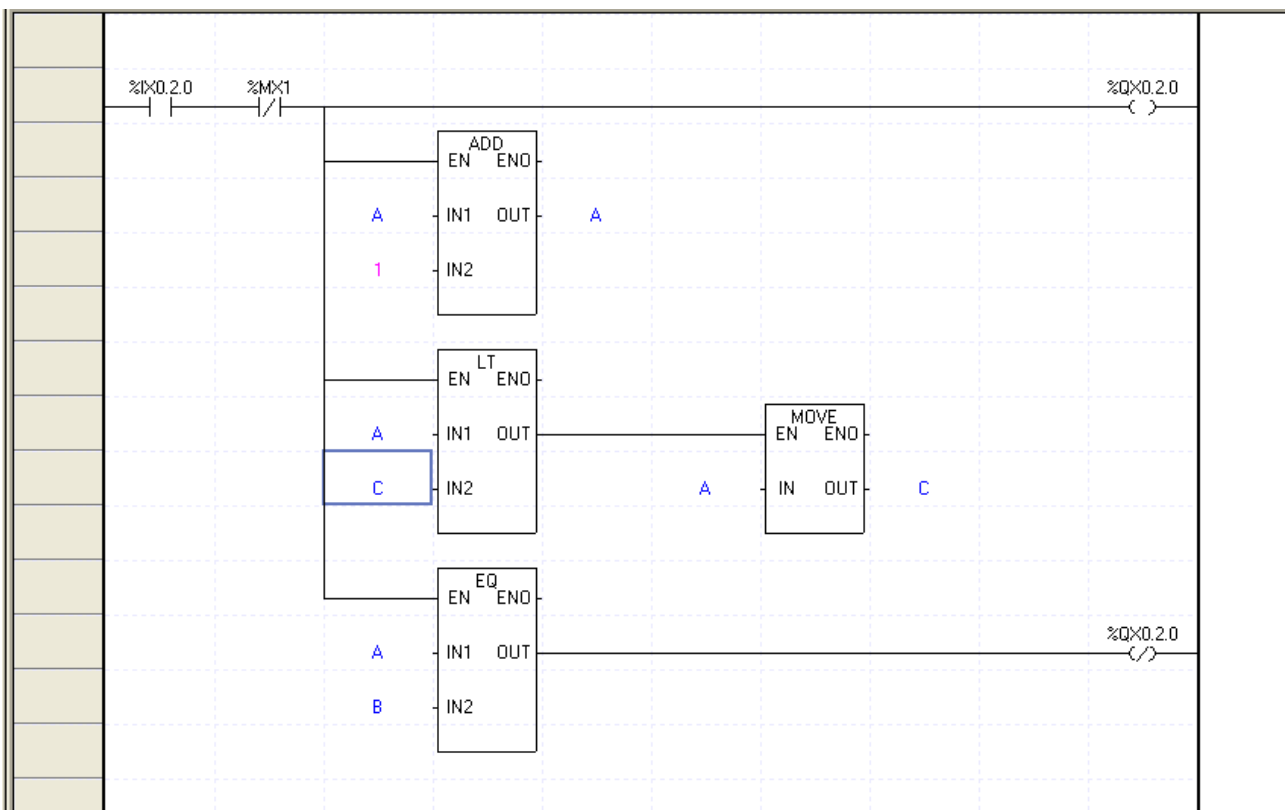

2. Select [Find/Replace]-[Find Device] on the menu.

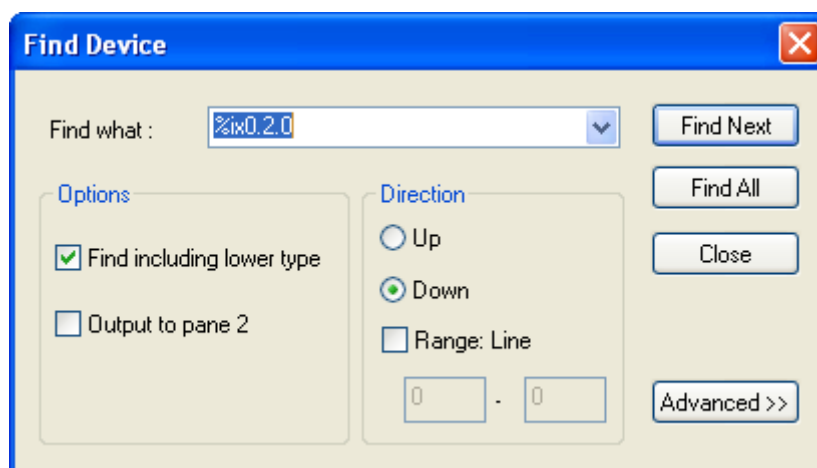

## Chapter 8 Find/Replace

- Specify the device to find, the direction and the options.

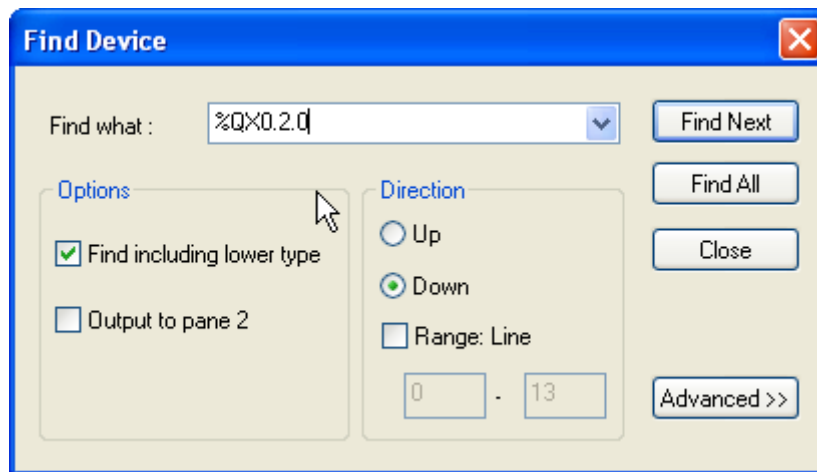

- Click [Find Next]. If on the Dialog Box any device is found identical to the detail as specified, move to the device whose cell is identical.

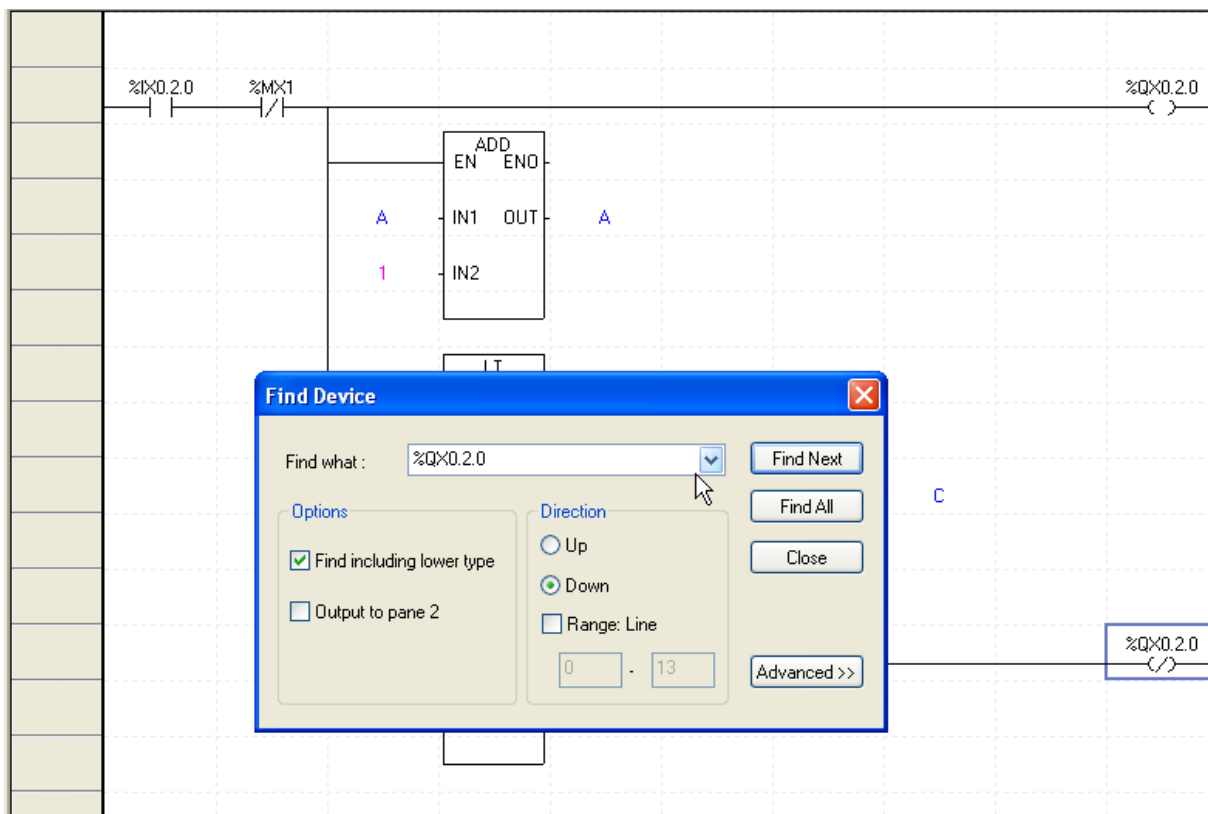



## Notes

- If on the dialog box no device is found identical to the detail as specified, the following message will appear.

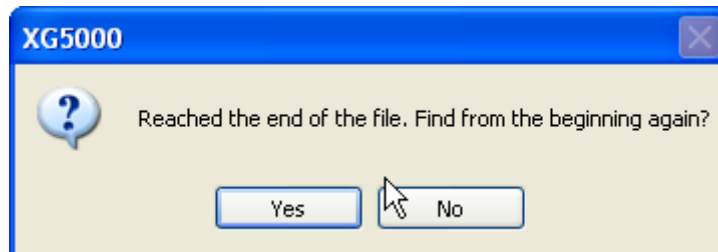

- [Find Next] will find all the present programs based on the selected cell when the device find dialog box is displayed. Namely, if the direction is set Downward, it will start to find the device identical right from the next cell of the selected cell to the last of the programs, and then the device identical again from the first of the programs to the basic cell.

### 8.1.2 Find All Device

It is used for LD, SFC, IL, Global/Direct Variable and Local Variable in common.

Details of this function will be described below based on LD.

[Steps]

1. Select [Find/Replace]-[Find Device] on the menu.
2. Specify the device to find, the direction and the options.
3. Click [Find All]. Find All will yield its result on the find message window as below.

```

x In NewPLC, finding device "%QX0.2.0"...
4   SCREEN_CAPTURE[Program](Row 1, Column 31):  -( )-  %QX0.2.0
   SCREEN_CAPTURE[Program](Row 11, Column 31):  -( /)- %QX0.2.0
2 device(s) found

```

Message Window

Result \ Check Program \ Find 1 \ Find 2 \ Communication \ Cross Reference \ Used Device \ Duplicate Co

## Chapter 8 Find/Replace

- On the find window, select the line to find and then click [Enter] to move the cell to the line of the applicable LD program.

The screenshot displays a ladder logic program with three rungs. The first rung contains a normally open contact labeled %IX0.2.0 and a normally closed contact labeled %MX1. The second rung contains an ADD instruction with IN1 set to A and IN2 set to 1. The third rung contains an EQ instruction with IN1 set to A and IN2 set to B. A MOVE instruction is connected to the output of the EQ instruction, with IN set to A and OUT set to C. The output of the MOVE instruction is connected to a coil labeled %QX0.2.0. A search window is open at the bottom, showing the search results for the device %QX0.2.0.

/Device	Value	Type	Device/Variable
In NewPLC, finding device "%QX0.2.0"...			
SCREEN_CAPTURE[Program]	(Row 1, Column 31):	-( )-	%QX0.2.0
SCREEN_CAPTURE[Program]	(Row 11, Column 31):	-(/)-	%QX0.2.0
2 device(s) found			

### Notes

- Find All finds the device in all the programs included in the present PLC.

## 8.2 Find Text

This function is used to find the String of Rung Comment, Variable, Variable Comment, Application Instruction and Label except the device.

[Dialog Box]

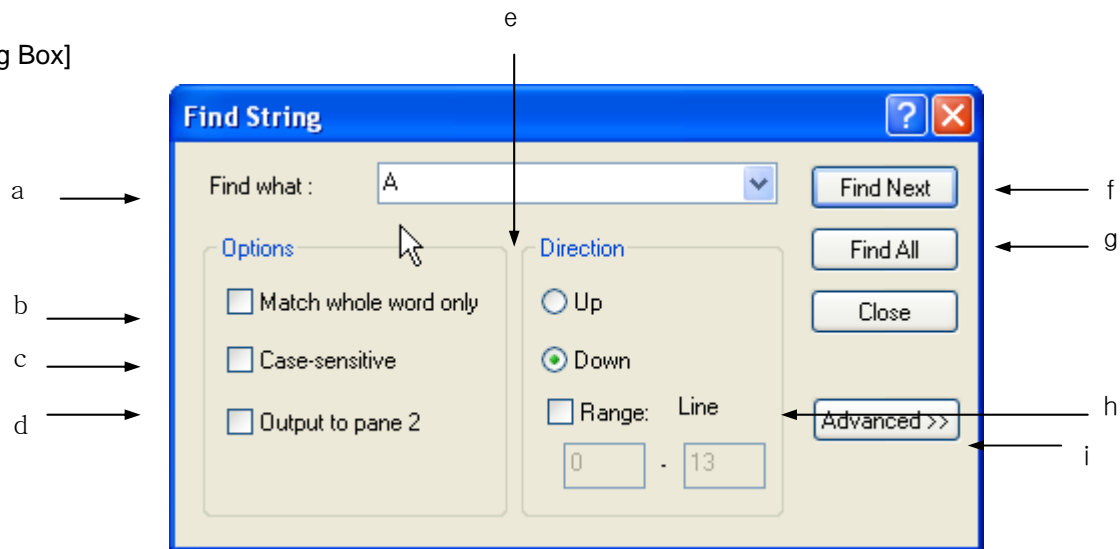

[Description of Dialog Box]

- Find what: used to specify the String to find.
- Match whole word only: If All Identical checked, it will find the string only exactly identical to the string specified in the detail to find. If not checked, it will find also the string where the detail to find is included.
- Case-sensitive: If this checked, it will find the string only exactly identical to the string with Case-sensitive characters sorted out. If not checked, it will find the string in characters not sorted out.
- Output to pane 2: XG5000 has two Find result windows. Basically the result is yielded to Find 1 result window, but if this check box is selected, the result will be yielded to Find 2 result windows.
- Direction: used to specify the location to find upward or downward from the line presently selected in the respective editor.
- Find Next: finds the detail specified above right in the next to the line (position) presently selected. If the applicable String is found, the position the applicable String is located will be selected.
- Find All: finds all the details specified above to display the result on the Find result window.
- Range: if Range is selected, Find Sting is executed in a specific step. If Range is selected, the start and last steps should be also entered.
- Advanced>>: It is only used in LD editor. 'Advanced>>' and 'Advanced<<' is changed by click. It is used to find specific contact point, specific coil and application instruction used in LD editor.

## Chapter 8 Find/Replace

### Notes

- The result will be displayed on the Find windows 1 and 2 only with Find All executed.
- Since Find All finds all details in the applicable documents, the direction is not significant to select.
- Advanced>> is displayed only in LD editor.
- Advanced>> (extension) and Advanced<< (shrink) is as shown below.

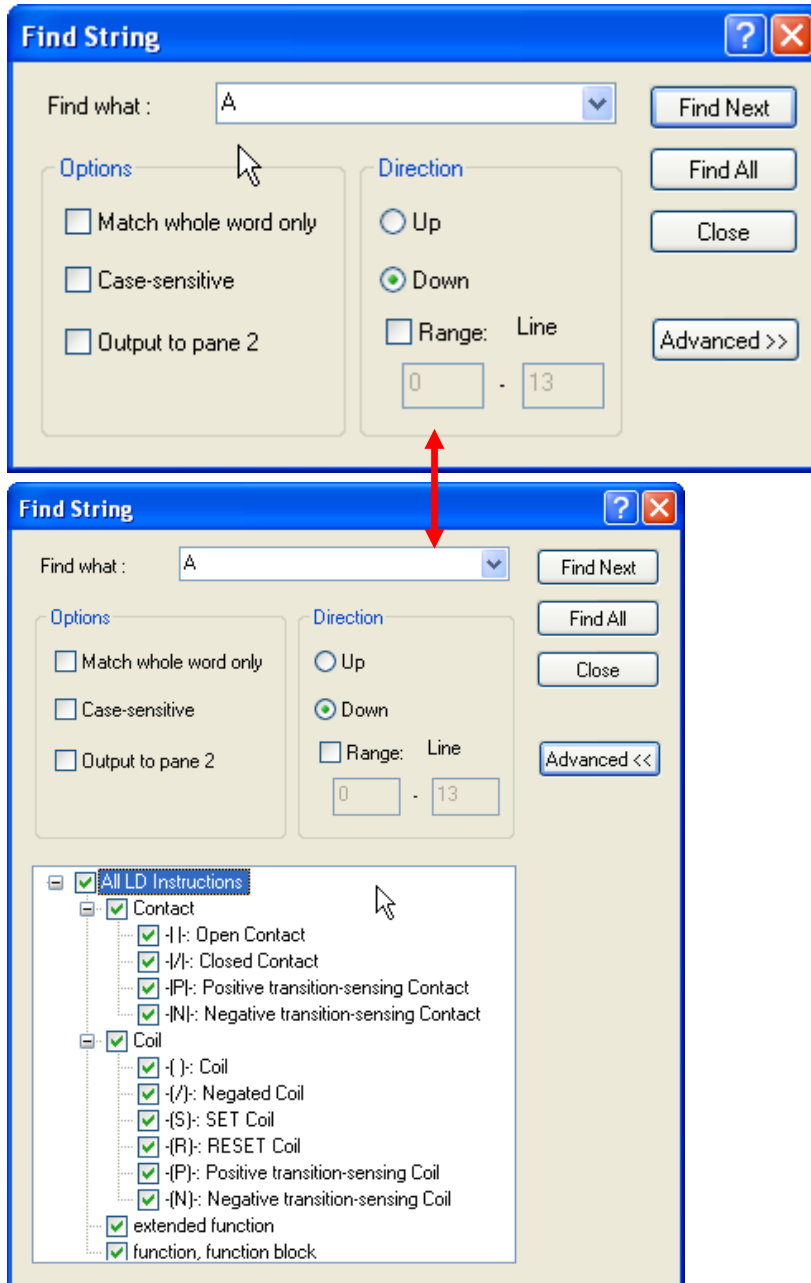

### 8.2.1 Find Text

It is used for LD, SFC, IL, Global/Direct Variable, Variable and Local Variable in common. Details of this function will be described below based on LD.

[Steps]

Select the basic cell of the direction.

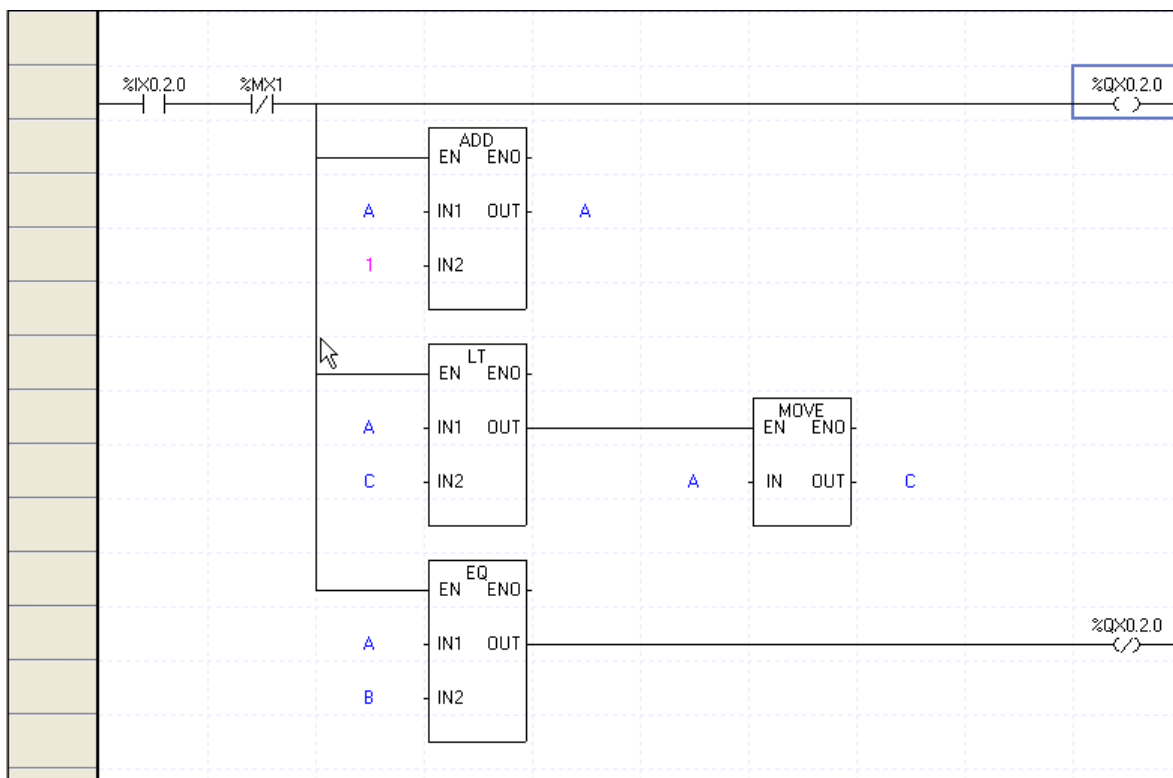

1. Select [Find/Replace]-[Find Text] on the menu.

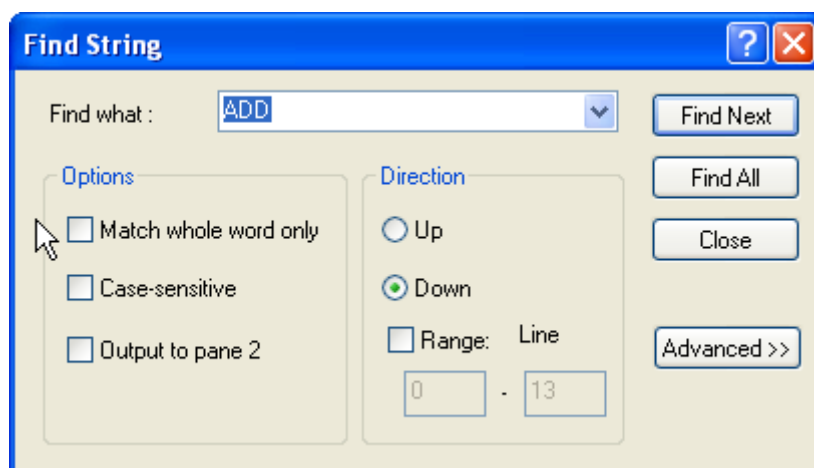

## Chapter 8 Find/Replace

- Specify the String to find, the selection options and the direction.

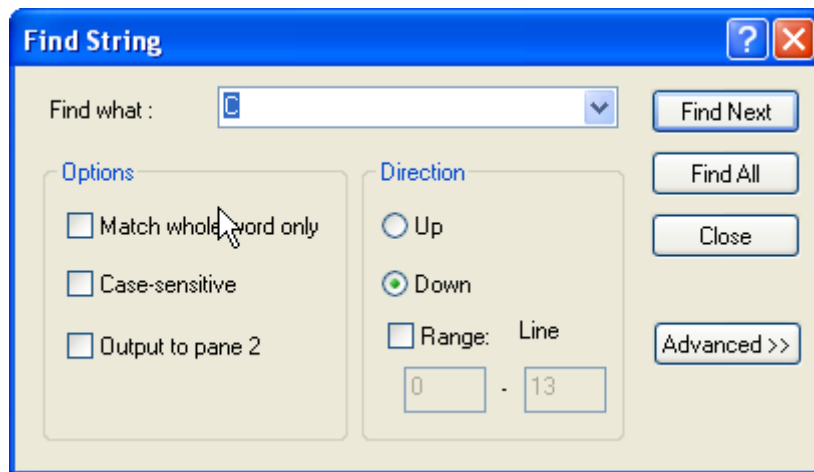

- Click [Find Next]. If on the dialog box any string is found identical to the detail as specified, it moves to the string whose cell is identical.

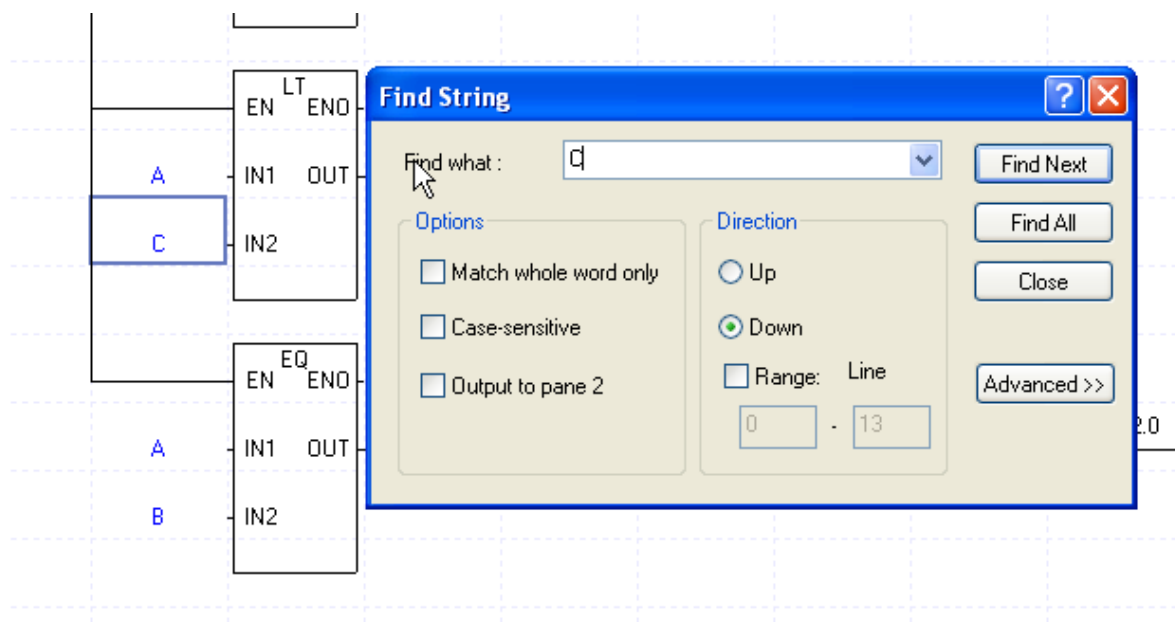

## Notes

- If on the dialog box no String is found identical to the detail as specified, the following message will appear.

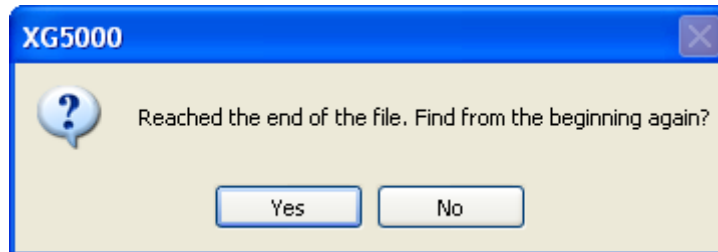

- [Find Next] will find all the present programs based on the selected cell when the String Find Dialog Box is displayed. Namely, if the direction is set Downward, it will start to find the String identical right from the next cell of the selected cell to the last of the programs, and then the String identical again from the first of the programs to the basic cell.

## 8.2.2 Find All String

It is used for LD, SFC, IL, Global/Direct Variable and Local Variable in common.

Details of this function will be described below based on LD.

[Steps]

1. Select [Find/Replace]-[Find String] on the menu.

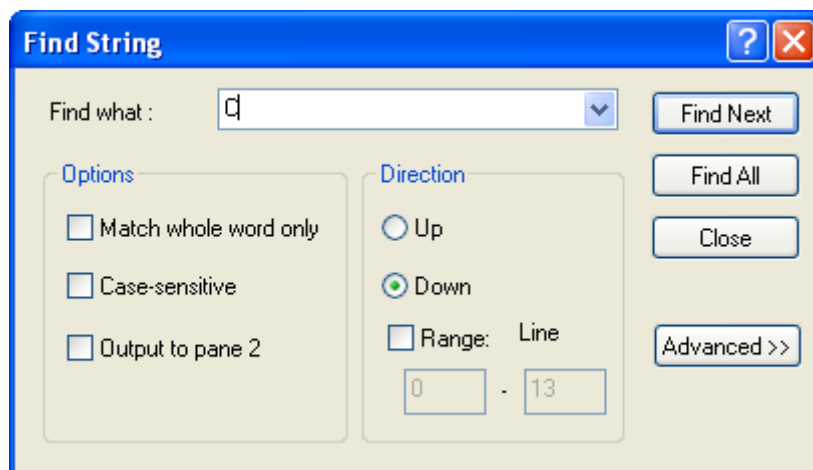

## Chapter 8 Find/Replace

- Specify the string to find, the selection options and the direction.

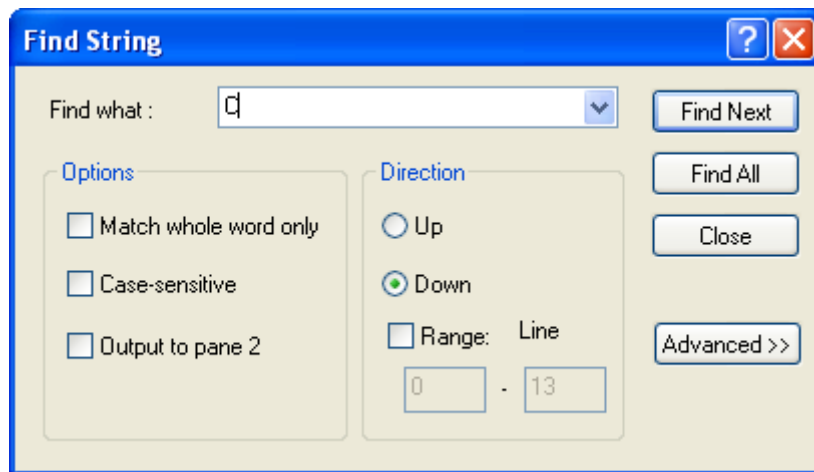

- Click [Find All]. Find All will yield its result on the find message window as below.

```
x In NewPLC, finding "C" ...
4 SCREEN_CAPTURE[Program](Row 1, Column 1):      -|/|-  Acontact
  SCREEN_CAPTURE[Program](Row 8, Column 2):      - VAR - C
  SCREEN_CAPTURE[Program](Row 8, Column 7):      - VAR - C
3 string(s) found
```

Message Window

Result \ Check Program \ Find 1 \ Find 2 \ Communication \ Cross Reference \ Used Device \ Duplicate Co



- On the find window, select the line to find and then click [Enter] to move the cell to the line of the applicable LD program.

The screenshot shows a PLC ladder logic program with the following components:

- Network 1:** A normally open contact labeled '1' connected to the IN2 input of an 'LT' (Load Transfer) coil. The EN and END terminals are also shown.
- Network 2:** A normally open contact labeled 'A' connected to the IN1 input of an 'EQ' (Equal) coil. The EN and END terminals are also shown.
- Network 3:** A normally open contact labeled 'B' connected to the IN2 input of an 'EQ' (Equal) coil. The EN and END terminals are also shown.
- Network 4:** A normally open contact labeled 'A' connected to the IN1 input of a 'MOVE' coil. The EN and END terminals are also shown.
- Network 5:** A normally open contact labeled 'C' connected to the IN2 input of a 'MOVE' coil. The EN and END terminals are also shown.
- Network 6:** A normally open contact labeled 'A' connected to the IN1 input of a coil that outputs to '%QX0.2.0'.

The search results window is open, showing the following results:

Type	Device/Variable
SCREEN_CAPTURE[Program](Row 1, Column 1):	- / - Acontact
SCREEN_CAPTURE[Program](Row 8, Column 2):	- VAR - C
SCREEN_CAPTURE[Program](Row 8, Column 7):	- VAR - C

3 string(s) found

Message Window: Result \ Check Program \ Find 1 \ Find 2 \ Communication \ Cross Reference \ Used Device \ Dup

### Notes

- Find All finds the String in all the programs included in the present PLC.

### 8.3 Replace Device

This function is used to change the device previously made in LD Editor, IL Editor, or Variable/Comment Editor.

[Dialog Box]

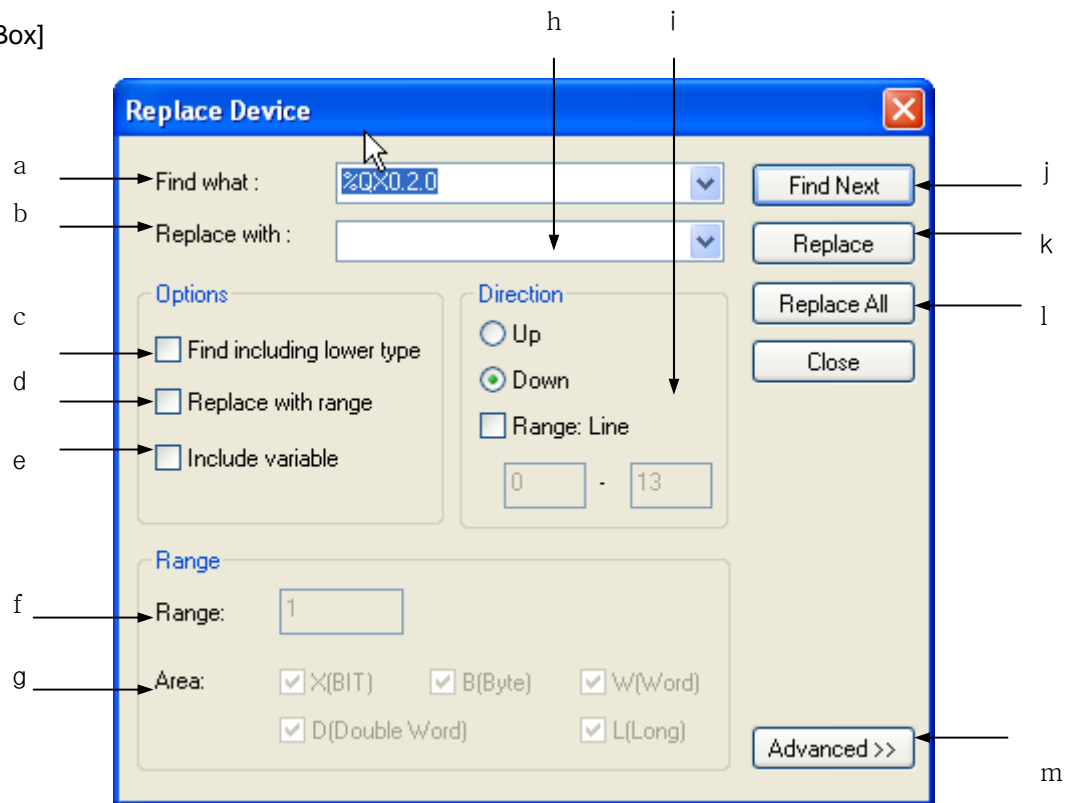

[Description of Dialog Box]

- a. Find what: used to specify the device to find.
- b. Replace with: used to specify the device to replace.
- c. Find including lower type: If selecting the checkbox when finding the device containing the device input in Find With, it finds %IB0.1.0, %ID0.1.0, %IL0.1.0 and others including %IX0.1.1.
- d. Replace with range: if checking Mass Change, the number of device and the coverage to mach change so that the devices can be mass changed.
- e. Include Variable: selects whether to replace the variable/comment of the input device with the variable/comment of the device to replace. That is, select whether to replace with the variable/comment of the device.
- f. Range: designates the number of device for mass change. It is activated only when the Mass Change checkbox is checked.
- g. Area: selects whether to contain by device types. If mass changing %IL0.0.1, for instance, they can be mass changed by selecting bit, byte, word and double word less than L area respectively.
- h. Direction: used to specify the location to find upward or downward from the line presently selected in the respective editor.
- i. Range: if selecting Range, Device Change can be executed within a specific line. If selecting Range, the start and last lines should be also entered.
- j. Find Next: finds the detail specified above right in the next to the line (position) presently selected. If the applicable device is found, the position the applicable device is located will be selected.
- k. Replace: Replaces the device as specified above based on the presently selected position (line).
- l. Replace All: Replaces all the details specified above after found.
- m. Advanced>>: It is only used in Ladder editor. 'Advanced>>' and 'Advanced<<' is changed by click. It is used to find specific contact point, specific coil and extended function/function block used in Ladder editor.

### Notes

- It is insignificant to select the direction in the case of Replace All.
- If 'Replace with range' is checked, Replace All only will be available.
- Advanced>> is displayed only in LD editor
- Message box is same as chapter 8.1 Find Device when 'Advanced' button is used.

### 8.3.1 Replace Device

It is used for LD editor, SFC editor and Variable/Comment in common. This is the function to fine the previously created device. Details of this function will be described below based on LD.

[Steps]

1. Select the basic cell of the direction.
2. Select [Find/Replace]-[Replace Device] on the menu.

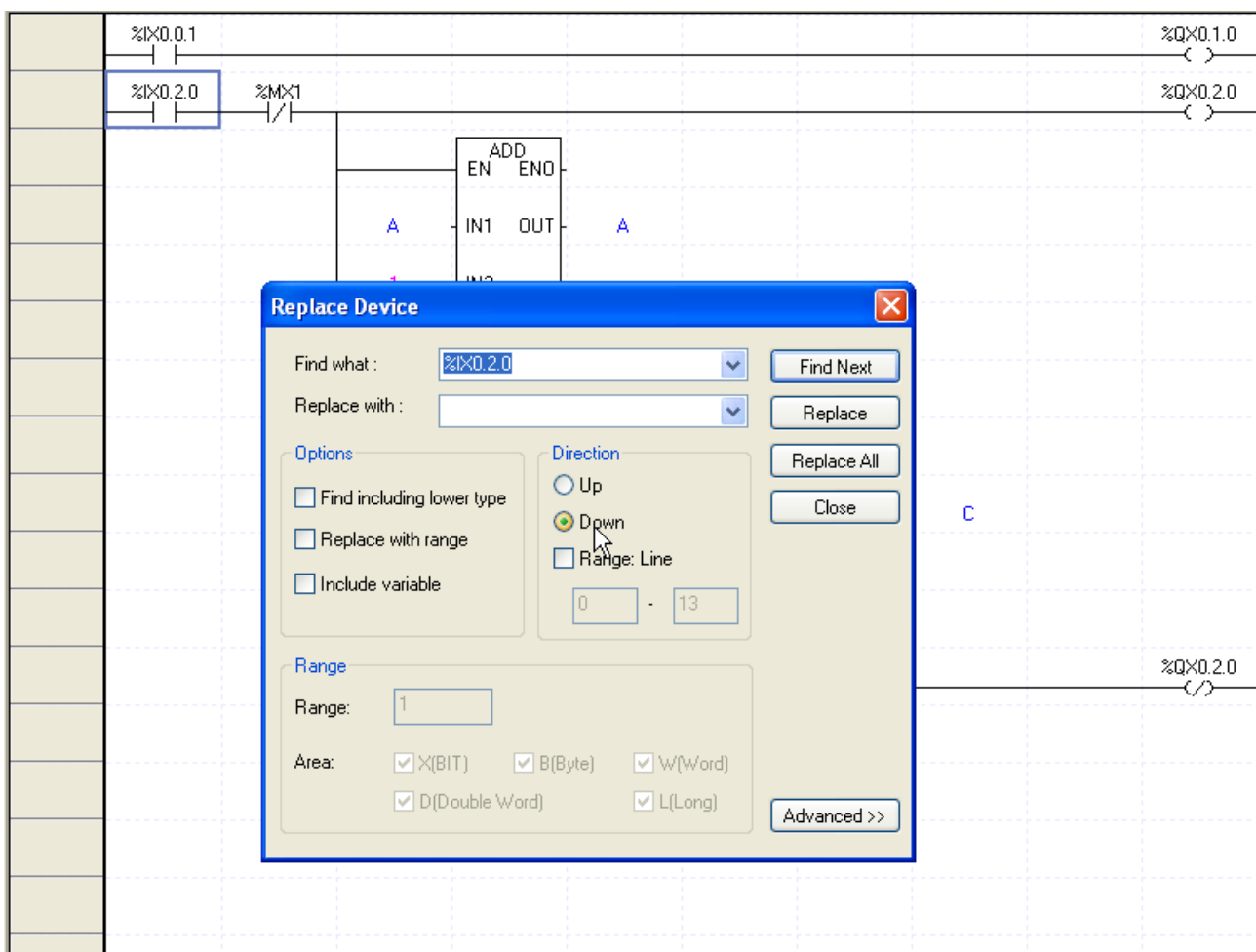

3. Specify the details to find and replace the type and the direction.

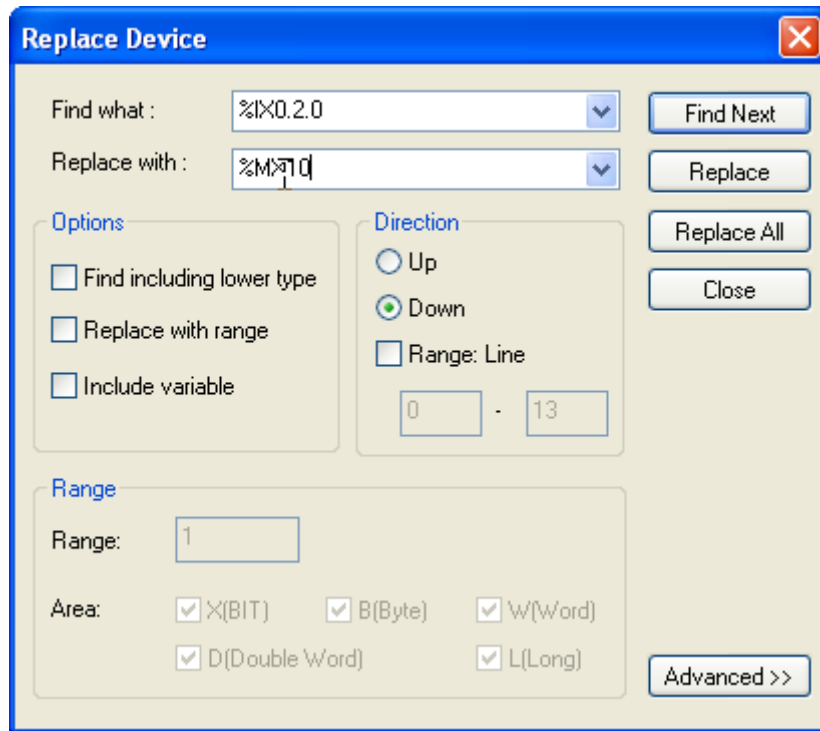

4. Click [Replace]. If the device of the cell presently selected is identical to the detail to find, replace the present cell to the detail as specified on the dialog box to move to the next cell identical to the detail to find.

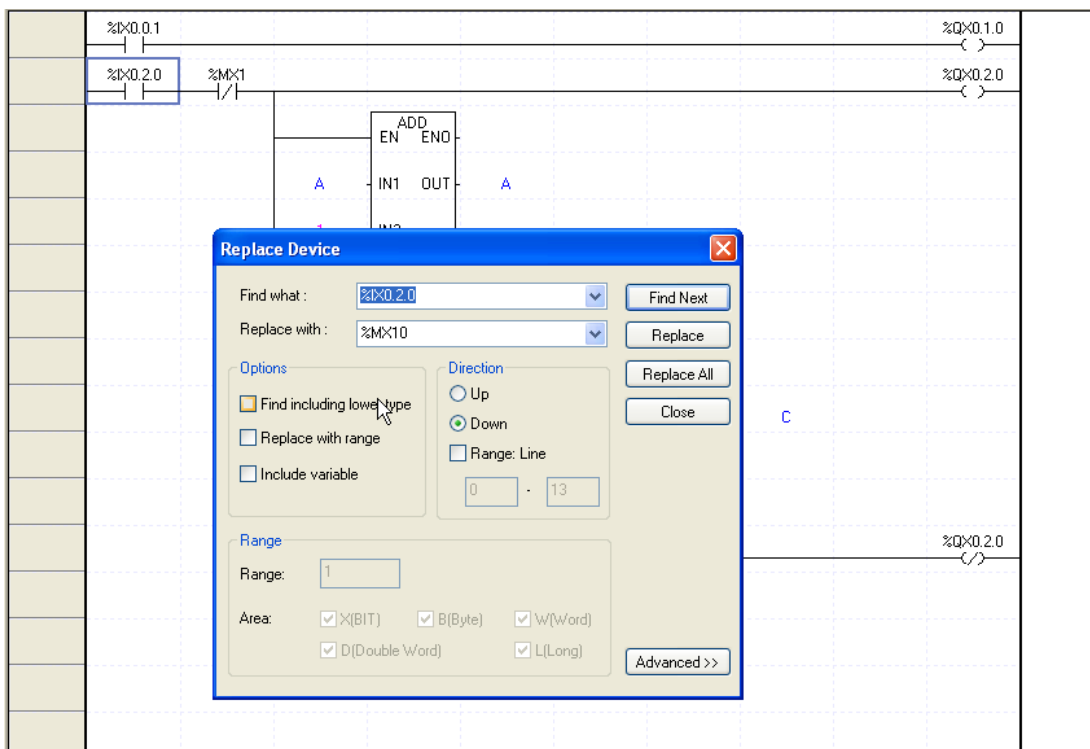

## Chapter 8 Find/Replace

Below screen is the previously executed [Replace].

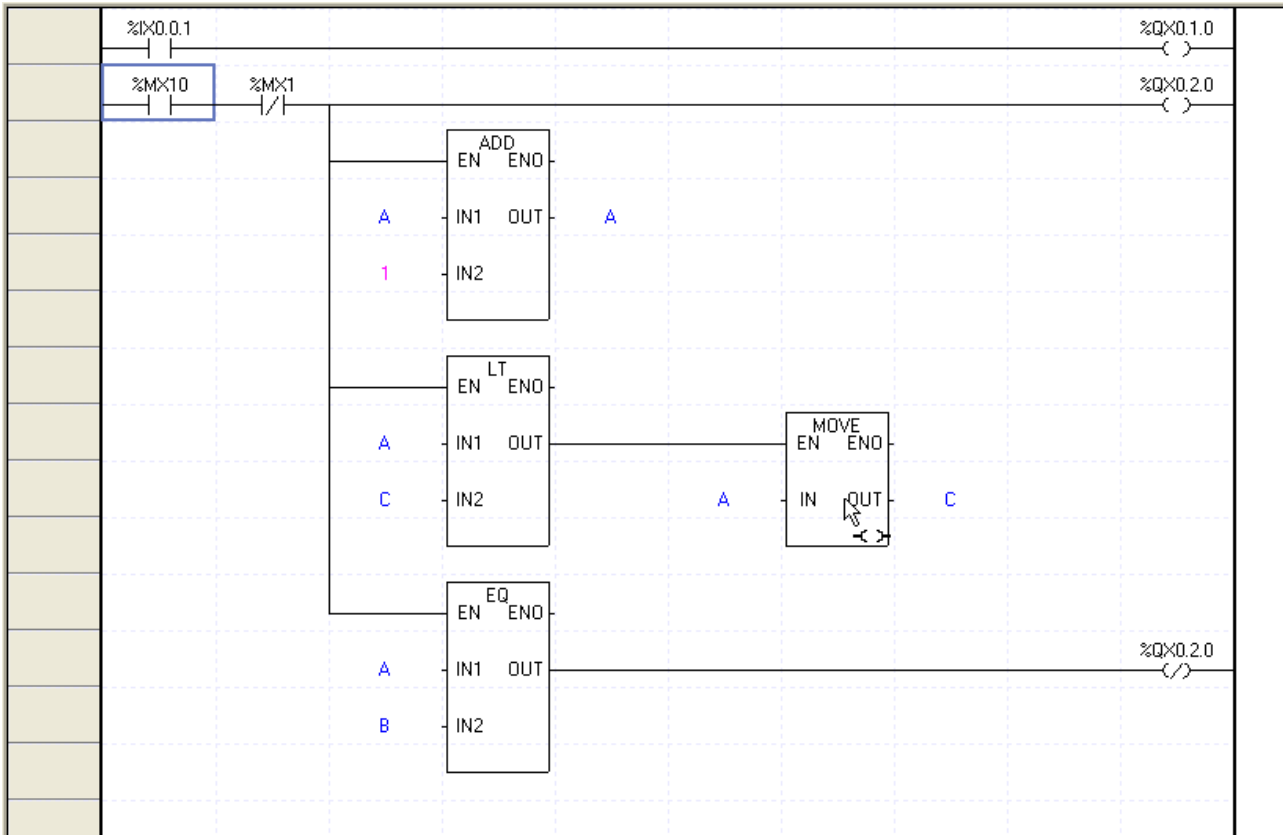

### Notes

- [Replace] will be available only when the device and the type of the cell presently selected are identical to the detail to find and to the type as specified on the dialog box.
- Click [Replace] to move to the next cell identical to the detail to find as specified on the dialog box regardless of the execution of [Replace].
- [Replace] will find all the present programs based on the selected cell when the device Replace dialog box is displayed. Namely, if the direction is set downward, it will start to find the device identical from the cell selected to the last of the programs, and then the device identical again from the first of the programs to the basic cell.

### 8.3.2 Replace All Device

It is used for LD editor, SFC editor and Variable/Comment editor in common. This is used to find the previously created device. Details of this function will be described below based on LD.

#### 1) All Change

[Steps]

1. Select [Find/Replace] - [Replace All Device] on the menu.

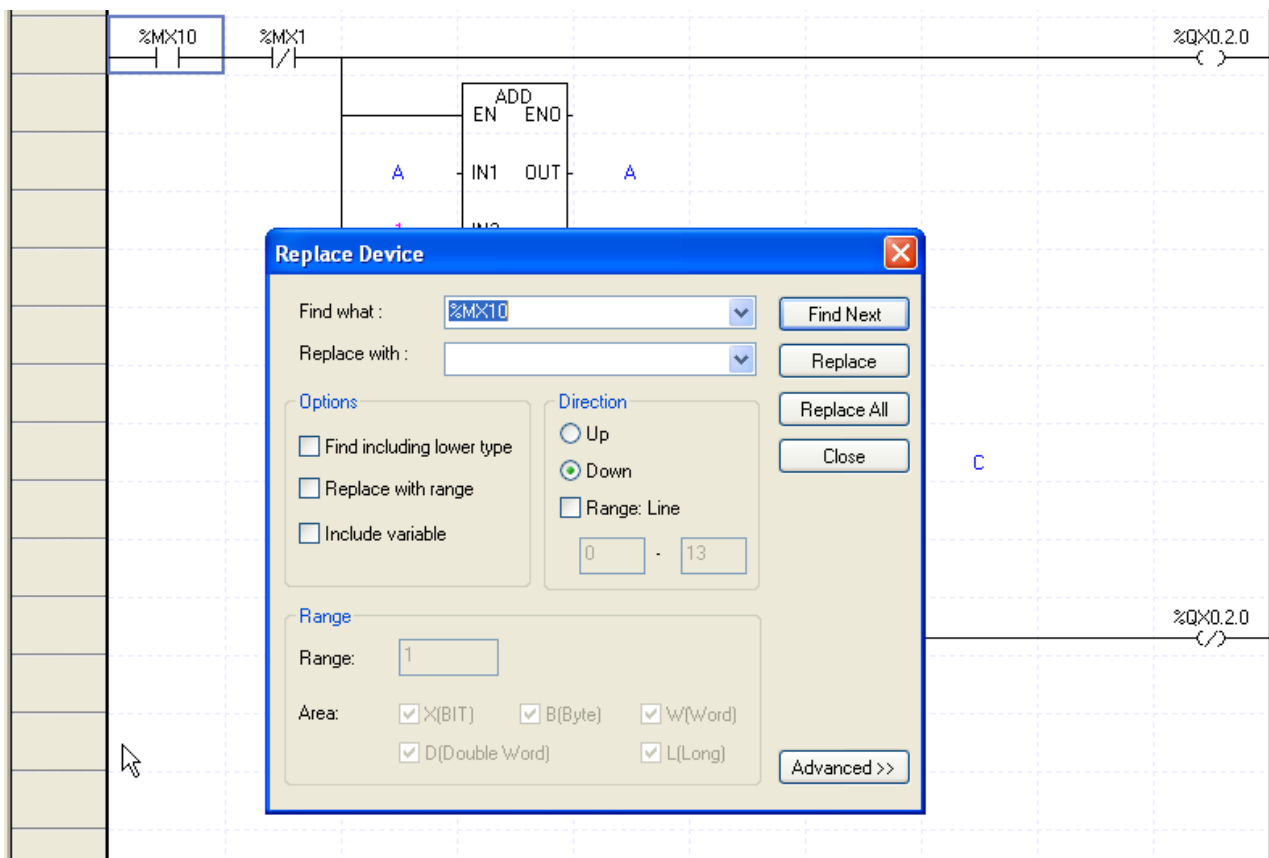

## Chapter 8 Find/Replace

- Specify the details to find and Replace the type and the direction.

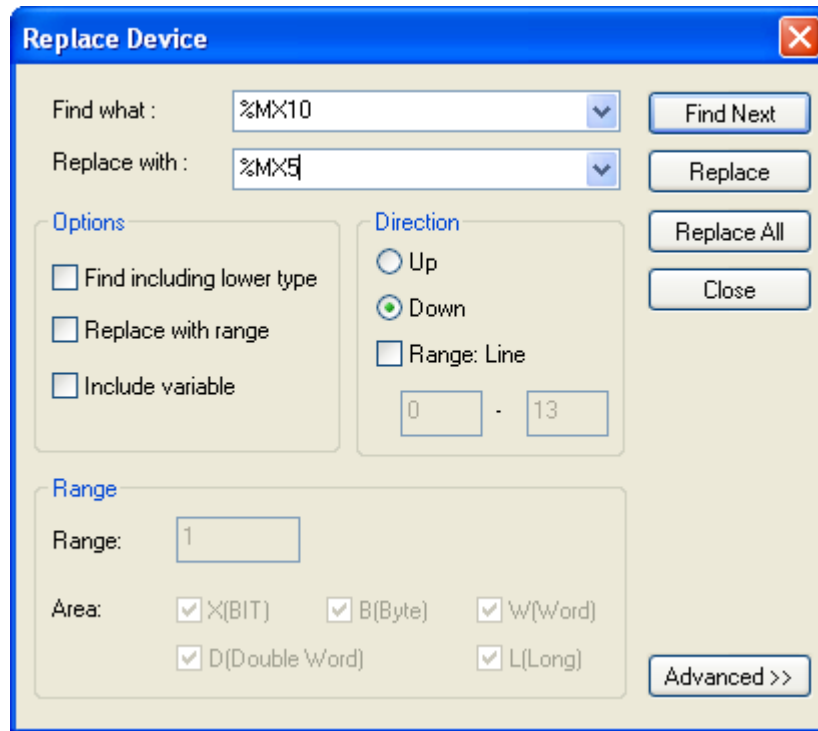

- Click [Replace All].
- If [Replace All] is complete in the present program, the following message box will appear.

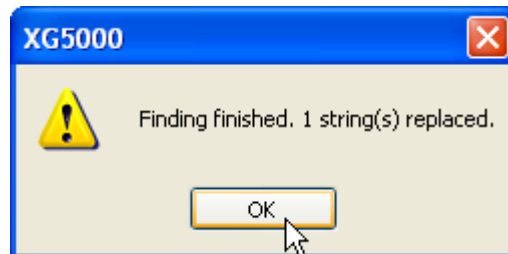

### 2) Replace with range

It is used to change the consecutive devices in bulk. For example, the devices of %MX1 ~ %MX10 can be changed to %MX100 ~ %MX109.

ex) If the detail to find is %MX1, the detail to change is %MX100 and the number of device is 10,

[Steps]

- Select [Find/Replace]-[Replace Device] on the menu.
- Specify the details to Find and Replace the type and the direction, check the Range Replace box and then input the number of devices to Replace with range.



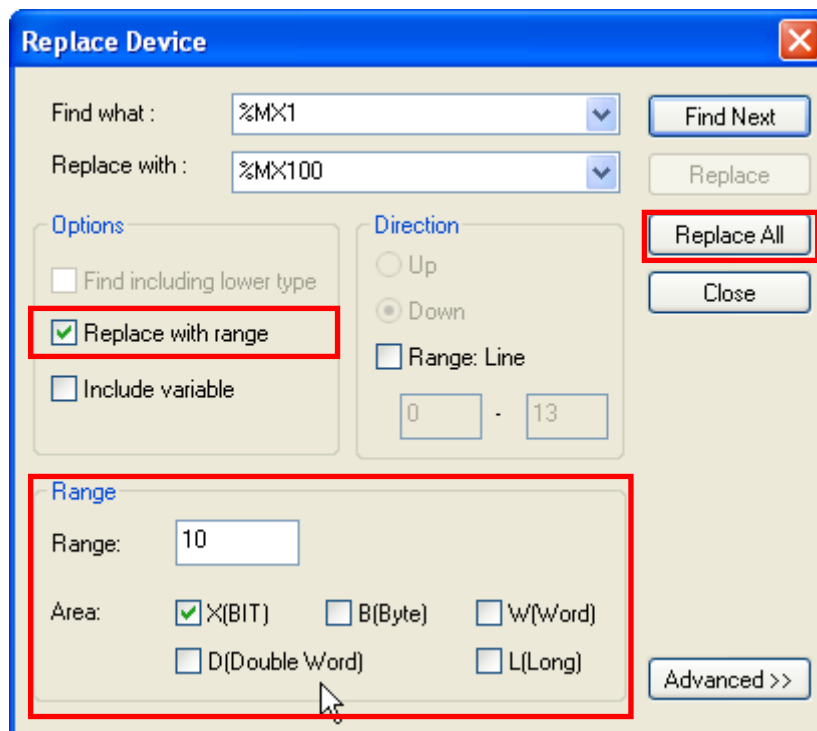

3. Click [Replace All].

#### Notes

– 'Replace with range' is available only for the devices, not for the constants.

### 8.4 Replace String

This function is used to find the String of Comment, Variable, etc. except the device.

[Dialog Box]

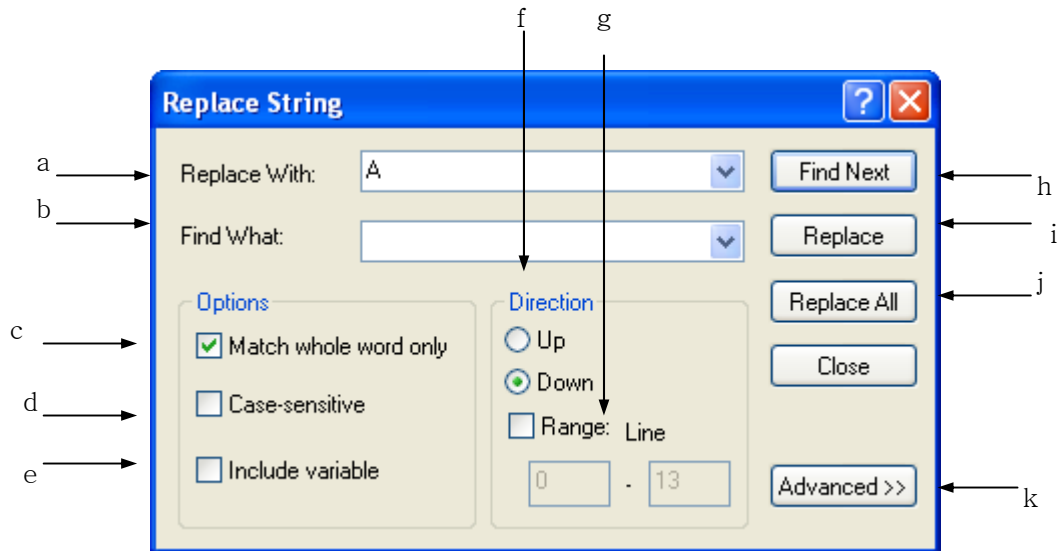

[Description of Dialog Box]

- a. Replace With: used to specify the string to find.
- b. Find What: used to specify the string to replace.
- c. Match whole word only: If All Identical checked, it will find the string only exactly identical to the string specified in the detail to find. If not checked, it will find also the string where the detail to find is included.
- d. Case-sensitive: If this checked, it will find the string only exactly identical to the string with Case-sensitive characters sorted out. If not checked, it will find the string in characters not sorted out.
- e. Include variable: If this checked, the variable will be also replaced as applicable when the string is replaced. If this is not checked, the variable will not be included in the replace when the string is replaced.
- f. Direction: used to specify the location to find upward or downward from the line presently selected in the respective editor...
- g. Range: if selecting a range, Replace String can be executed within a specific line. If Range is selected, the first and last steps should be entered.
- h. Find Next: finds the detail specified above right in the next to the line (position) presently selected. If the applicable string is found, the cell will move to the position the applicable string is located.
- i. Replace: replaces the detail specified above after found.
- j. Replace All: replaces all the details specified above after found.
- k. Advanced>>: It is only used in Ladder editor. 'Advanced>>' and 'Advanced<<' is changed by click. It is used to find specific contact point, specific coil, extended function, function/function block used in Ladder editor.

### Notes

- Advanced>> is displayed only in Ladder editor
- Message box is same as chapter 8.2 Find Device when 'Advanced' button is used.

### 8.4.1 Replace String

It is used for LD editor, SFC editor and Variable/Comment editor in common. It is used to find the previously created device. Details of this function will be described below based on LD.

[Steps]

1. Select the basic cell of the direction.

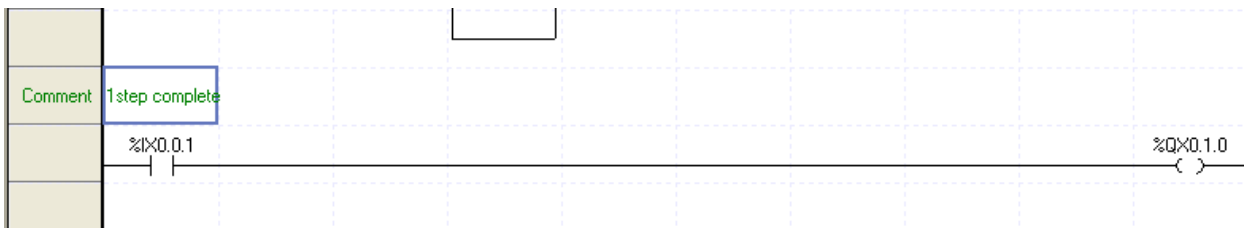

2. Select [Find/Replace]-[Replace String] on the menu.

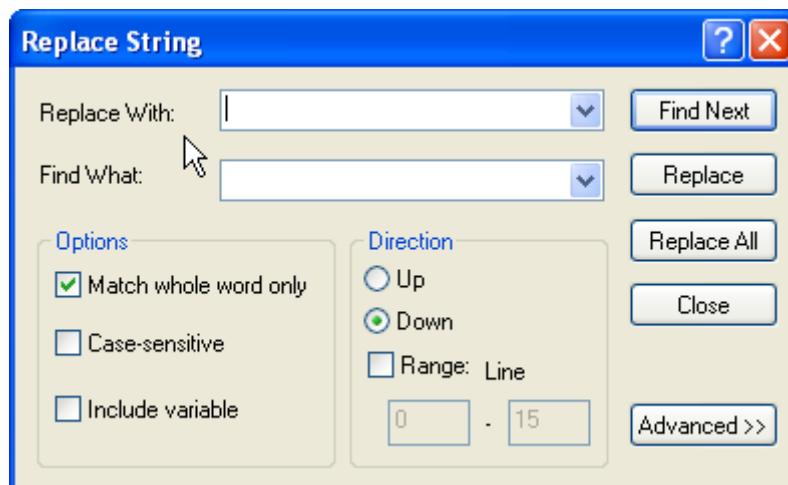

## Chapter 8 Find/Replace

- Specify the String to find and replace the selection options and the direction.

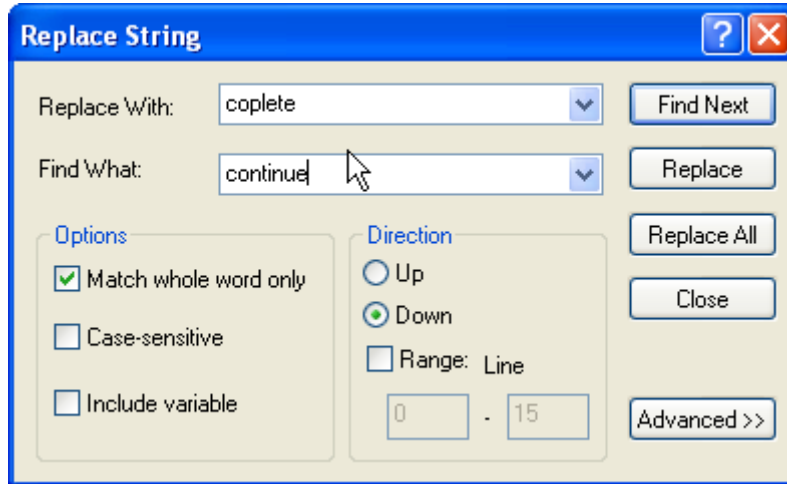

- Click [Replace]. If the string of the cell presently selected is identical to the detail to find, replace the present cell to the detail as specified on the dialog box to move to the cell identical to the detail to find.

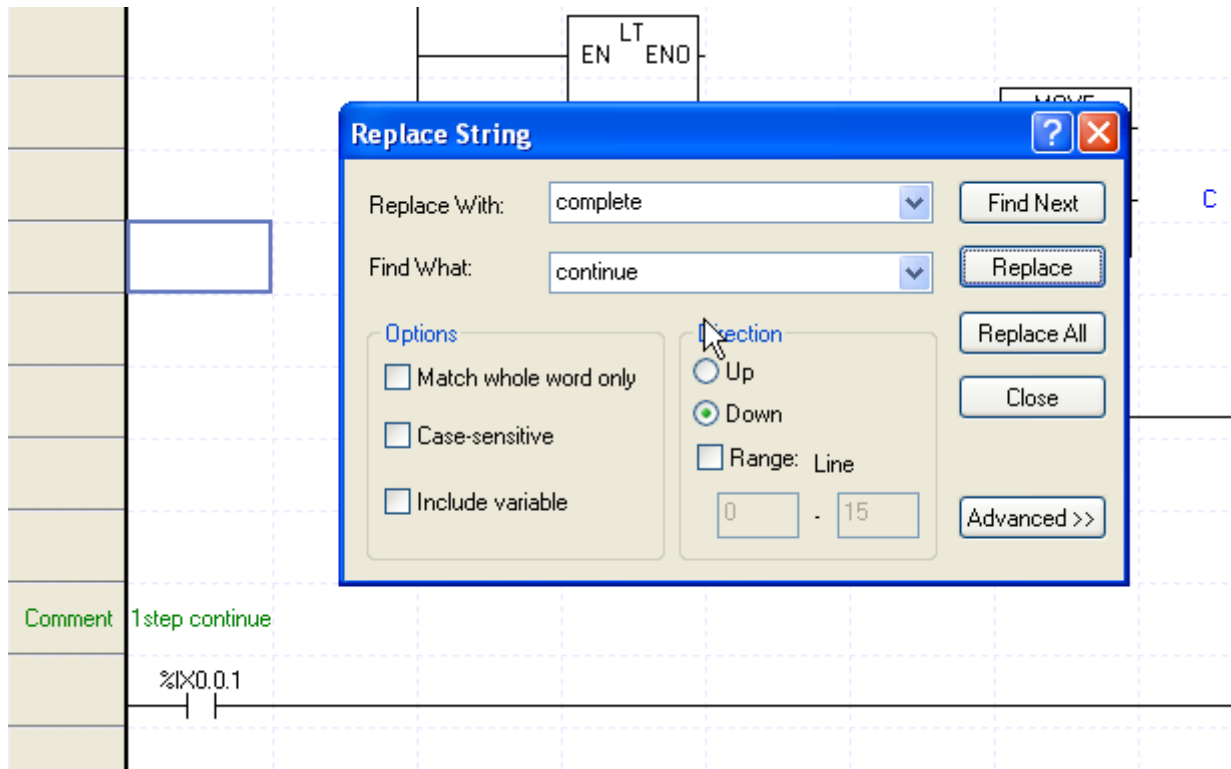

### Notes

- [Replace] will be available only when the string of the cell presently selected is identical to the detail to find as specified on the dialog box.
- Click [Replace] to move to the next cell identical to the detail to find as specified on the dialog box regardless of the execution of [Replace].
- [Replace] will find all the present programs based on the selected cell when the device Replace dialog box is displayed.

### 8.4.2 Replace All String

It is used for LD editor, SFC editor and Variable/Comment editor in common. It is used to find the previously created device. Details of this function will be described below based on LD

[Steps]

1. Select [Find/Replace]-[Replace String] on the menu.

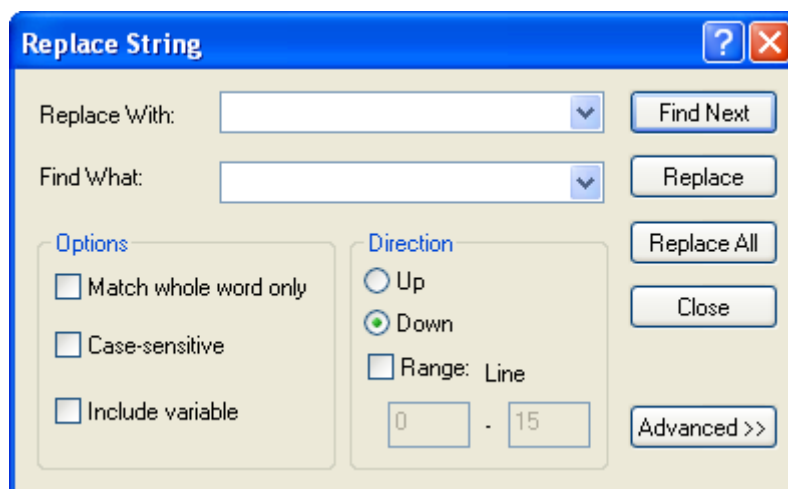

## Chapter 8 Find/Replace

- Specify the details to Find and Replace the selection options and the direction.

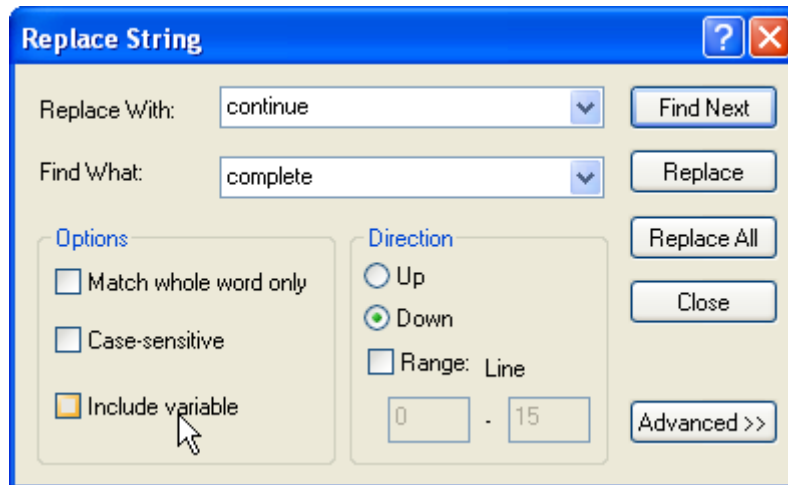

- Click [Replace All].
- If [Replace All] is complete in the present program, the following message box will appear for you to decide to Replace in the other program or not.

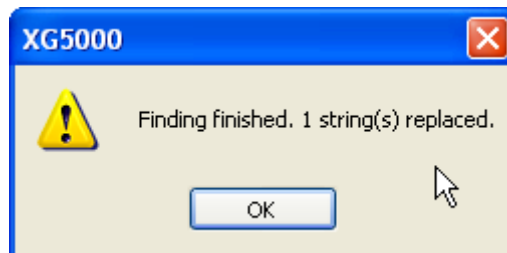

## 8.5 Find Again

[Find Again] is used to find the details of [Find Device] or [Find String] again if once executed previously. If [Find] was not executed previously, it will be inactive.

[Steps]

Select [Find/Replace]-[Find Again] on the menu.

# Chapter 9 Parameter

## 9.1 Basic Parameter

It is used to specify the basic parameters related with PLC operation.

[Steps]

1.1. On the project tree, double-click [Parameter]-[Basic Parameters].

1) Basic Operation Setting

[Dialog Box]

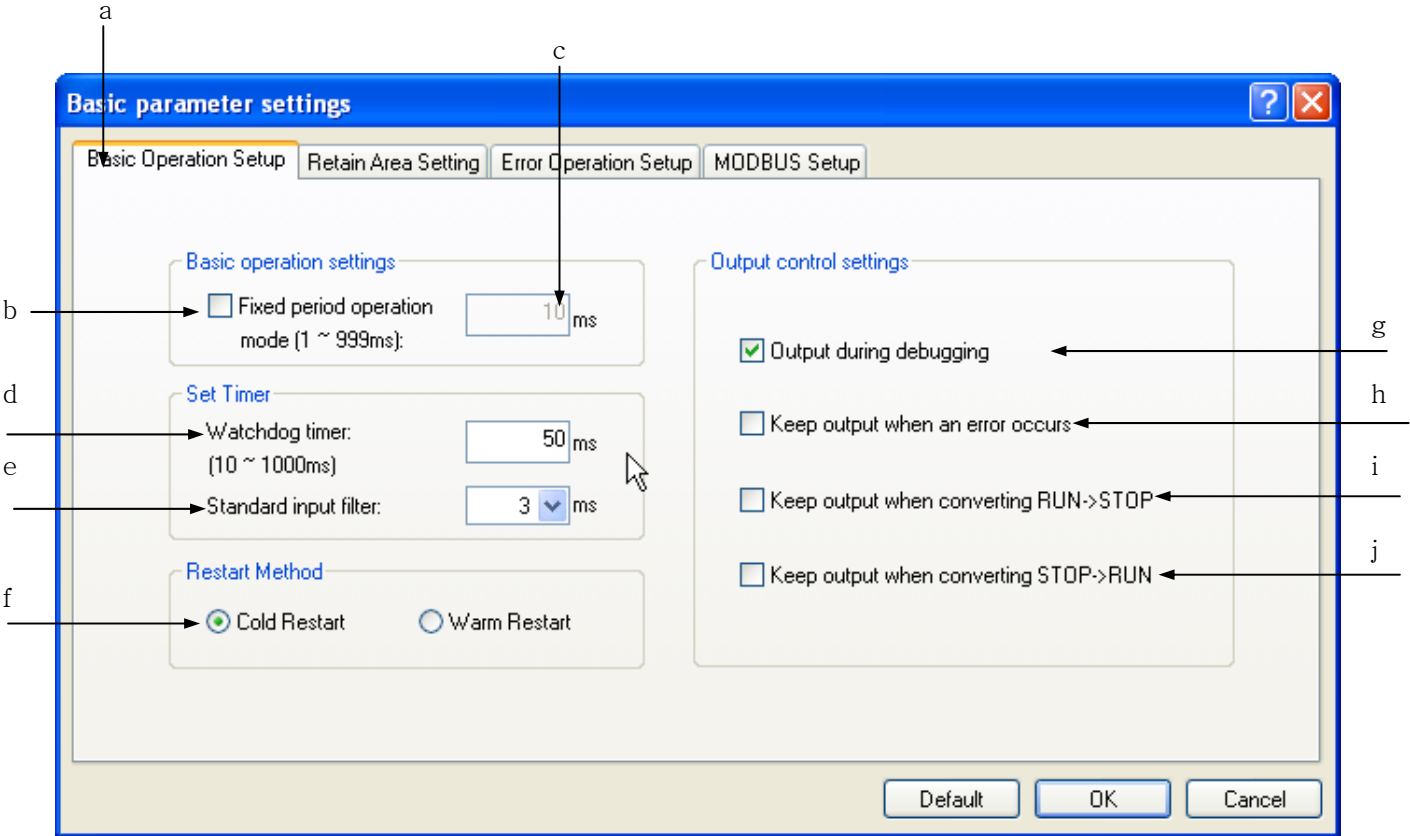

[Description of Dialog Box]

a. Basic Operation Settings: used to specify setting of basic operation, time, restart method and output control of [Basic Parameters] information



## Chapter 9 Parameter

- b. Fixed period operation: used to decide to run the PLC program based on the fixed period operation or based on the scan time.
- c. Fixed period operation time setting: if Fixed period operation above is checked, input the operation time in ms unit.
- d. Watch Dog timer: used to specify the time value of the scan watch-dog timer to keep PLC from stopping due to program error.
- e. Standard input filter: used to specify the standard input value. For more details, refer to the 9.2.4 notes.
- f. Restart mode: sets the restart mode. Select either cold or warm restart.
- g. Output during debugging: used to decide to output the data to the output module as usual or not even while being debugged.
- h. Keep Output when an error occurs: used to decide to output the data to the module as usual or not even when an error or a specific input occurs.
- i. Keep Output when converting RUN->STOP: used to decide to output the data to the module as usual or not even when PLC operation mode is converted from RUN to STOP.
- j. Keep Output when STOP->RUN: used to decide to output the data to the module as usual or not even when PLC operation mode is converted from STOP to RUN..

### 2. Compile Option Setup

[Dialog Box]

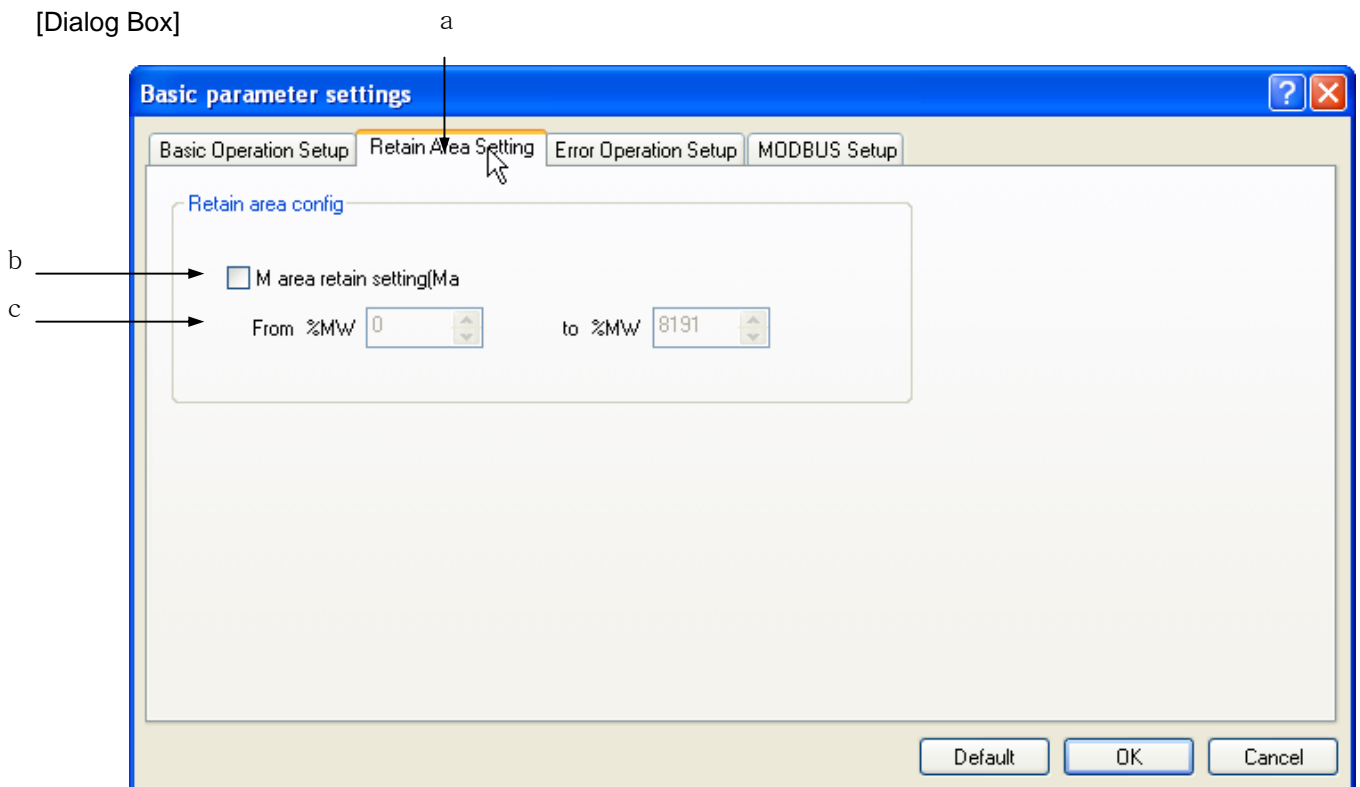

[Description of Dialog Box]

- a. Retain Area Setup: sets the options necessary for Retain Area in the [Basic Parameter] information.
- b. M area Retain setting: sets the M area (retain area) to preserve the data when turning on PLC.
- c. Set the size of the data preservation area. It can be set within M area size in the unit of Device WORD.  
The size set for M area can not be more than the half M area size (65,536).

3. Error Operation Setup

[Dialog Box]

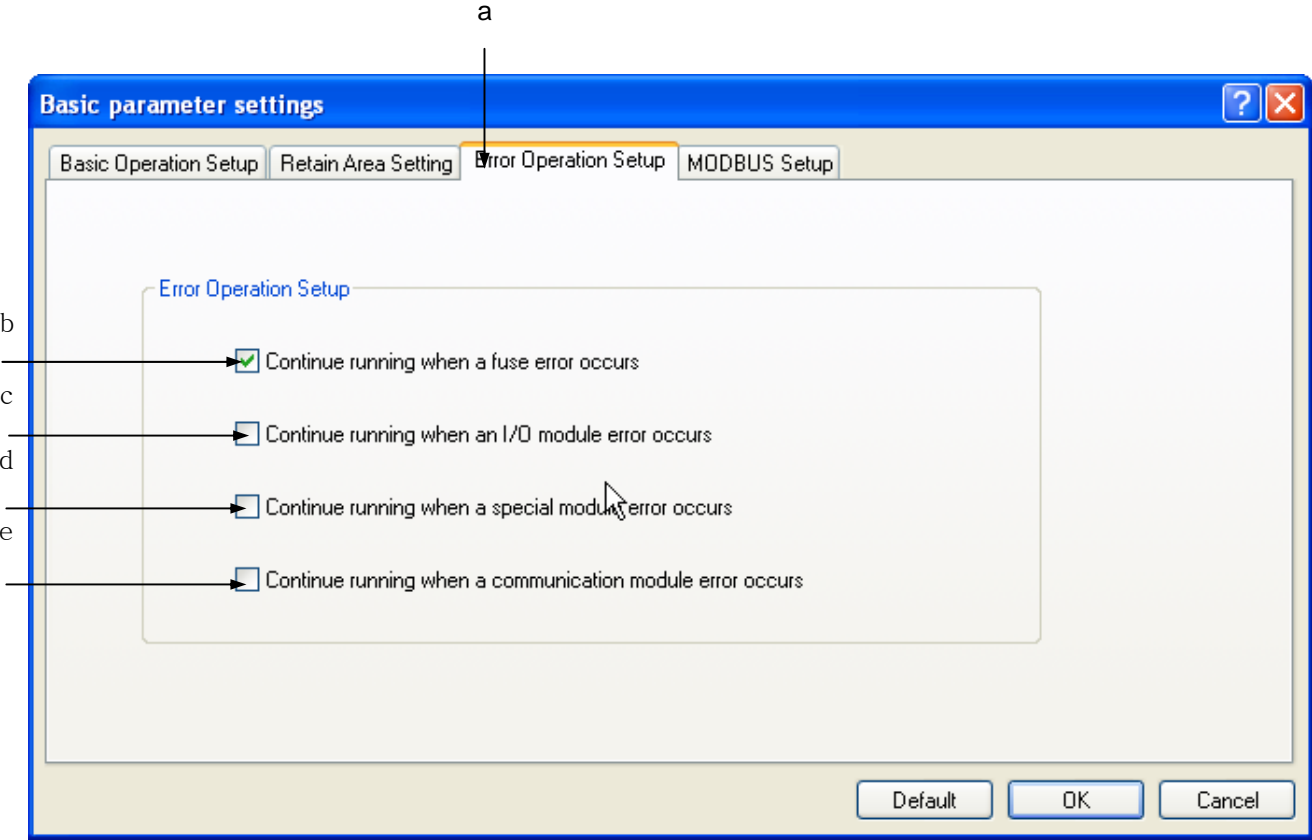

## Chapter 9 Parameter

[Description of Dialog Box]

- Error Operation Setup: specifies the operation method when an error occurs on PLC among [Basic Parameters] information.
- If this option is selected, PLC will continuously run although an error occurs on the fuse connection status of the module during PLC RUN.
- If this option is selected, PLC will continuously run although an error occurs on I/O module during PLC RUN.
- If this option is selected, PLC will continuously run although an error occurs on the special module during PLC RUN.
- If this option is selected, the PLC continues operating although an error occurs on the communication module.

### 4. MODBUS Setup

[Dialog Box]

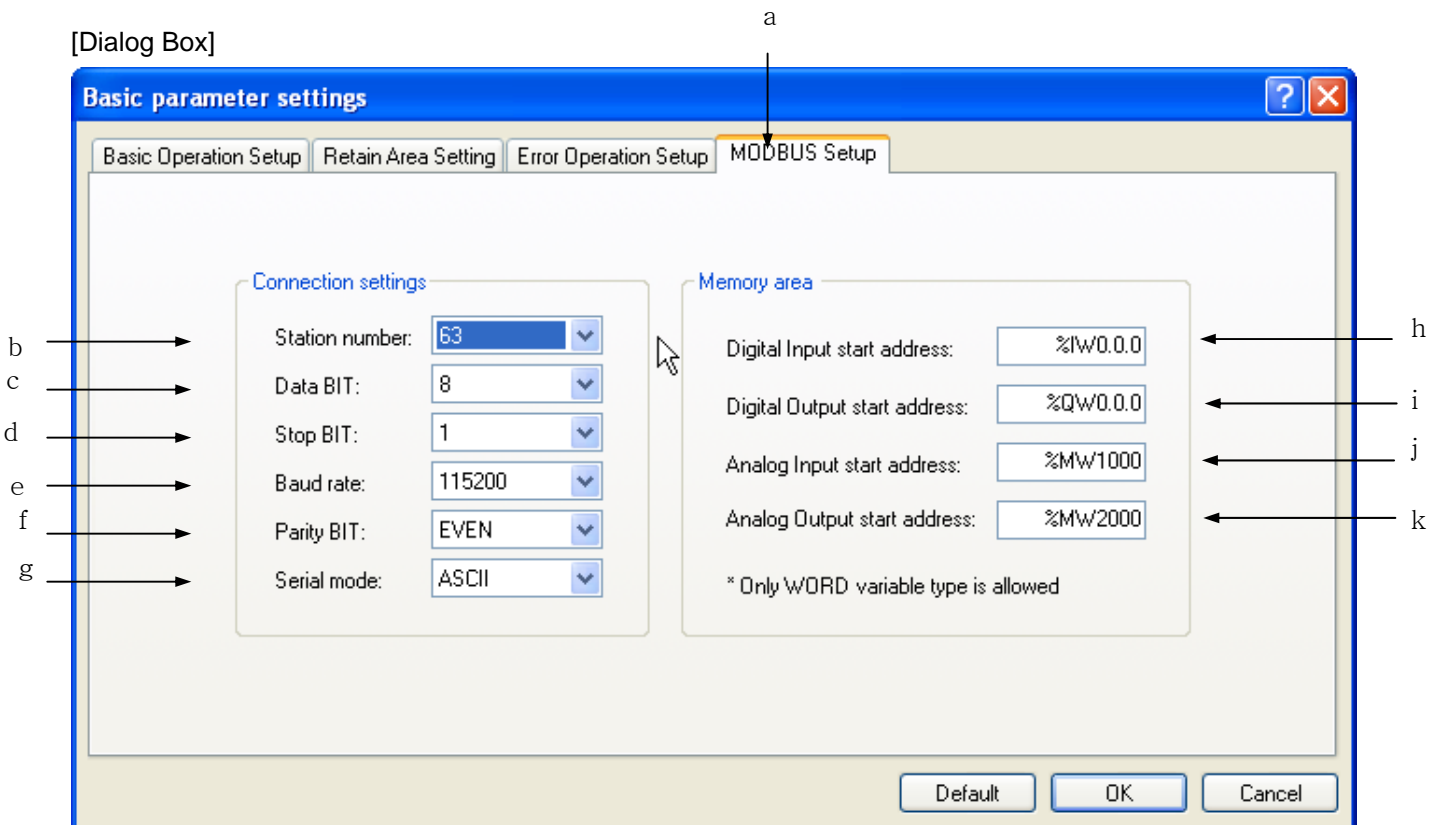

[Description of Dialog Box]

- a. MODBUS Setup: specifies MODBUS basic information among [Basic Parameters] information
- b. Station number: specifies the station Number used for MODBUS communication. 0~63 is available for the range.
- c. Data bit: changes the number of data bits used for each String received. It shall be set identical to the value specified in PLC communicating with the user. Most String is transferred in 7 or 8 data bits.
- d. Stop bit: changes the time (if time is measured by bit) required to transfer each String.
- e. COM speed: The maximum speed of the data to transfer through this port will be specified in bps (bit/sec). The maximum speed will be normally specified as much as supported by the communicating computer or device.
- f. Parity bit: specifies the parity bit.
- g. Transmission mode: specify the transference mode. ASCII communication and RTU communication are available.
- h. Used to specify the start address of DI (Digital Input) memory area to read through MODBUS, where the value should be specified in Word unit.
- i. Used to specify the start address of DO (Digital Output) memory area to read through MODBUS, where the value should be specified in Word unit.
- j. Used to specify the start address of AI (Analog Input) memory area to read through MODBUS, where the value should be specified in Word unit.
- k. Used to specify the start address of AO (Analog Output) memory area to read through MODBUS, where the value should be specified in Word unit.

### Notes

### Restart Mode

Restart mode is set to determine how to initialize variable and system and start RUN mode operation when starting RUN mode operation by turning it on again or mode conversion and there are two modes; cold and warm. The execution conditions of each restart mode are as follows.

#### - Cold Restart

- a) It is executed when setting the restart mode of parameter as cold restart.
- b) First of all, it clears every data but variables of which initial value is set to '0'.
- c) Even though the parameter is set to warm restart mode, it starts in cold restart mode when it is executed just after the program is changed.
- d) Pressing RESET switch during operation (same with online reset instruction), starts in the cold restart mode, regardless of the restart mode set in the parameter.

#### - Warm Restart

- a) It is executed when setting the restart mode of parameter as warm restart.
- b) The data set to remain the previous value remain the previous value while the data set only with the initial value are set with the initial values. Other data are cleared to '0'.
- c) If data is abnormal although the parameter is set in the warm restart (data preservation against interruption is not available), it is executed in the cold restart mode.

**9.2 I/O Parameters**

It is used to specify the I/O type to be applied to PLC slot and the applicable parameters for each slot.

[Steps]

1. On the project tree, select [Parameter]-[I/O Parameters].

[Dialog Box]

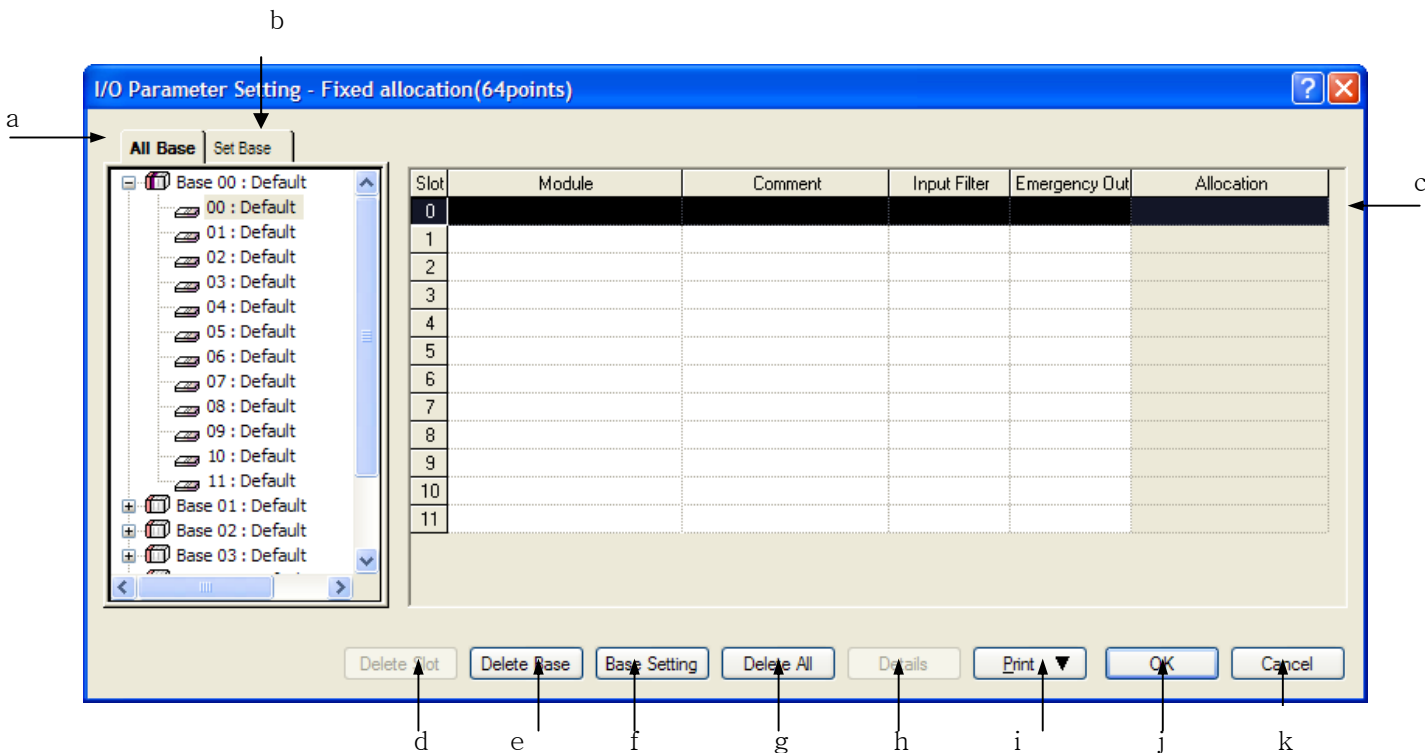

[Description of Dialog Box]

- a. Module List: displays the base module information and the module information based on slots. If no module is designated in the slot, it will be displayed in 'default'.
- b. Set Base: displays only module-selected base.
- c. Slot Information: edits or displays base's module type for each slot, where detailed module information and assigned information will be displayed.

### Notes

- The XGI project type supports the fixed allocation type only. Therefore, the allocation information column is always displayed as deactivated.

- d. Delete Slot: deletes all information of the presently selected slot.
- e. Delete Base: deletes all information of the presently selected base.
- f. Base Setting: sets slot number on base currently selected base.
- g. Delete All: deletes all information of all bases.
- h. Details: displays detailed module information.

### Notes

- Refer to XG-PD manual for details on the communication module information setting.
- Refer to APM manual for details on the positioning module information setting.

- b. Print: prints the module type and the module's parameter information specified in the slot.
- c. OK: applies the changed items and closes the Dialog Box.
- i. Cancel: closes the Dialog Box.

### 9.2.1 Base Module Information Setting

#### 1) Base Module Information Setting

It is used to specify the base information about module.

[Steps]

1. Select the base module to specify from the device list.
2. Click the right mouse button to select [Base Setting]. Or click Base Setting button.

[Dialog Box]

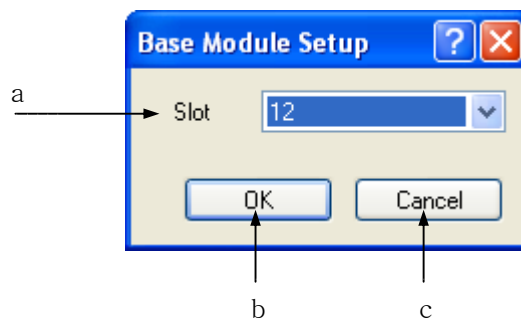

[Description of Dialog Box]

- a. Slot: used to input the maximum number of slots.
- b. OK: applies the changed items and closes the dialog box.
- c. Cancel: closes the dialog box.

### Notes

- If the specified number of slots is less than the maximum number of slots, the rest area is unavailable to edit.

## 2) Delete Base Module

[Steps]

1. Select the base module to delete from the device list.
2. Click the right mouse button to select [Delete Base].
3. [Delete] or [OK] message box will be displayed. Click [OK] button to delete the information of the applicable base module.

## 9.2.2 Module Information Setting Based on Slots

Module type and detailed module information will be described based on slots.

[Steps]



## Chapter 9 Parameter

1. Select the slot to specify the module in the slot information.
2. Select the arrow of the Module to display the module selection box. Or click the right mouse button to select [Edit].

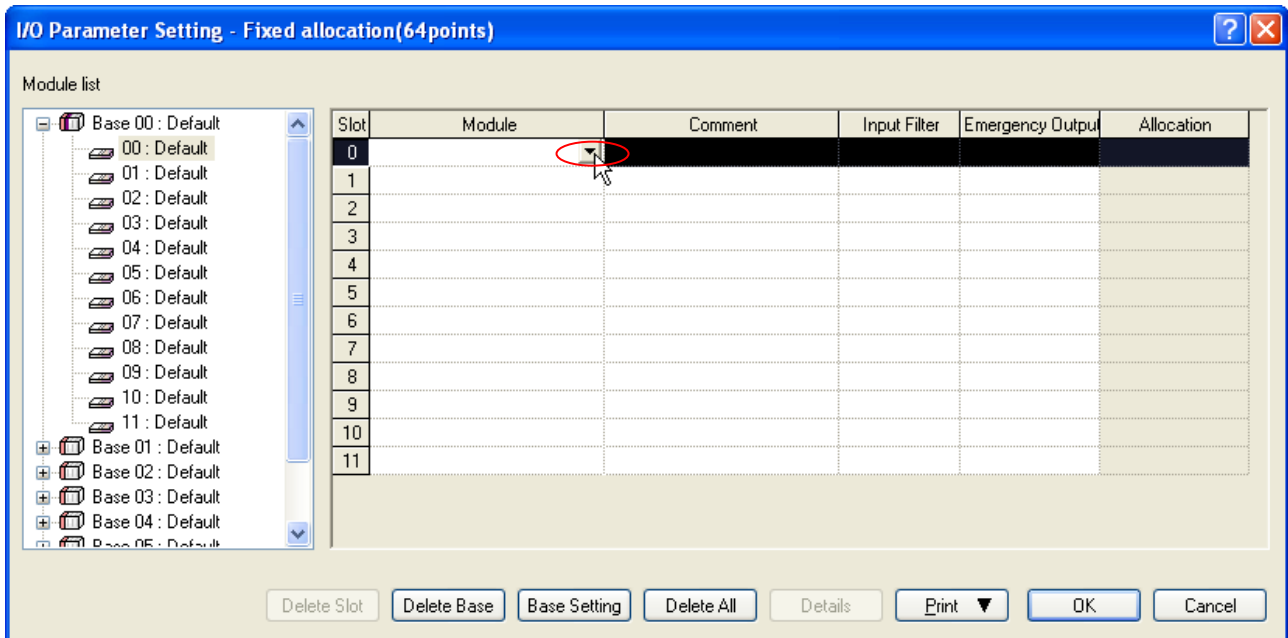

3. Press the selection box to select the module.

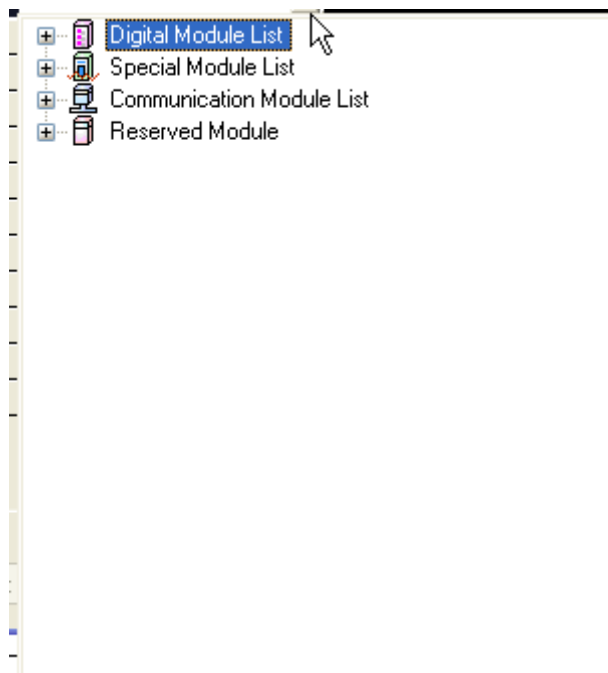

Slot	Module	Comment	Input Filter	Emergency Output	Allocation
0	XGF-AV8A (Voltage, 8-CH) ▾				
1					

4. Select the description column and then click the right mouse button to select [Edit]. And input the description String for the applicable slot.

**Notes**

- Up to 128 characters in English (up to 64 characters in Korean) is available to input for the module description.

**9.2.3 I/O Parameter Edit Function**

Data editing details of Copy, Cut and Paste will be described below, based on slots.

## Chapter 9 Parameter

### 1) Copy/Paste

[Steps]

1. Select the slot to copy.

Slot	Module	Comment	Input Filter	Emergency Output	Allocation
0	XGF-AV8A (Voltage, 8-CH)		-	-	
1	XGF-AV8A (Voltage, 8-CH)		-	-	
2	DC 24V INPUT, 8points		3 Standard [ms]	-	
3	DC 24V INPUT/TR OUTP		3 Standard [ms]	Default	
4					
5					
6					
7					
8					
9					
10					

2. Click the right mouse button to select [Copy].

3. Select the slot to paste.

Slot	Module	Comment	Input Filter	Emergency Output	Allocation
0	XGF-AV8A (Voltage, 8-CH)		-	-	
1	XGF-AV8A (Voltage, 8-CH)		-	-	
2	DC 24V INPUT, 8points		3 Standard [ms]	-	
3	DC 24V INPUT/TR OUTP		3 Standard [ms]	Default	
4					
5					
6					
7					
8					
9					
10					
11					

4. Click the right mouse button to select [Paste].

Slot	Module	Comment	Input Filter	Emergency Output	Allocation
0	XGF-AV8A (Voltage, 8-CH)		-	-	
1	XGF-AV8A (Voltage, 8-CH)		-	-	
2	DC 24V INPUT, 8points		3 Standard [ms]	-	
3	DC 24V INPUT/TR OUTP		3 Standard [ms]	Default	
4					
5	DC 24V INPUT/TR OUTP		3 Standard [ms]	Default	
6					
7					
8					
9					

2) Cut/Paste

1. Select the slot to cut.

Slot	Module	Comment	Input Filter	Emergency Output	Allocation
0	XGF-AV8A (Voltage, 8-CH)		-	-	
1	XGF-AC8A (Current, 8-CH)		-	-	
2	DC 24V INPUT/TR OUTP		3 Standard [ms]	Default	
3	XGF-DC4S (Isolated, 4-CH)		-	-	
4					
5					
6	DC 24V INPUT/TR OUTP		3 Standard [ms]	Default	
7					
8					
9					
10					
11					

2. Click the right mouse button to select [Cut].

Slot	Module	Comment	Input Filter	Emergency Output	Allocation
0	XGF-AV8A (Voltage, 8-CH)		-	-	
1					
2	DC 24V INPUT, 8points		3 Standard [ms]	-	
3	DC 24V INPUT/TR OUTP		3 Standard [ms]	Default	
4					
5	DC 24V INPUT/TR OUTP		3 Standard [ms]	Default	
6					
7					

## Chapter 9 Parameter

3. Select the slot to paste.

Slot	Module	Comment	Input Filter	Emergency Output	Allocation
0	XGF-AV8A (Voltage, 8-CH)		-	-	
1					
2	DC 24V INPUT, 8points		3 Standard [ms]	-	
3	DC 24V INPUT/TR OUTP		3 Standard [ms]	Default	
4					
5	DC 24V INPUT/TR OUTP		3 Standard [ms]	Default	
6					
7					
8					

4. Click the right mouse button to select [Paste].

Slot	Module	Comment	Input Filter	Emergency Output	Allocation
0	XGF-AV8A (Voltage, 8-CH)		-	-	
1					
2	DC 24V INPUT, 8points		3 Standard [ms]	-	
3	DC 24V INPUT/TR OUTP		3 Standard [ms]	Default	
4	XGF-AV8A (Voltage, 8-CH)		-	-	
5	DC 24V INPUT/TR OUTP		3 Standard [ms]	Default	
6					
7					

3) Undo

[Steps]

1. Select the slot to delete.

Slot	Module	Comment	Input Filter	Emergency Output	Allocation
0	XGF-AV8A (Voltage, 8-CH)		-	-	
1					
2	DC 24V INPUT, 8points		3 Standard [ms]	-	
3	DC 24V INPUT/TR OUTP		3 Standard [ms]	Default	
4	XGF-AV8A (Voltage, 8-CH)		-	-	
5	DC 24V INPUT/TR OUTP		3 Standard [ms]	Default	
6					
7					

2. Click the right mouse button to select [Delete].

Slot	Module	Comment	Input Filter	Emergency Output	Allocation
0	XGF-AV8A (Voltage, 8-CH)		-	-	
1					
2	DC 24V INPUT, 8points		3 Standard [ms]	-	
3	DC 24V INPUT/TR OUTP		3 Standard [ms]	Default	
4					
5	DC 24V INPUT/TR OUTP		3 Standard [ms]	Default	
6					
7					

3. Click the right mouse button to select [Undo].

Slot	Module	Comment	Input Filter	Emergency Output	Allocation
0	XGF-AV8A (Voltage, 8-CH)		-	-	
1					
2	DC 24V INPUT, 8points		3 Standard [ms]	-	
3	DC 24V INPUT/TR OUTP		3 Standard [ms]	Default	
4	XGF-AV8A (Voltage, 8-CH) ▾		-	-	
5	DC 24V INPUT/TR OUTP		3 Standard [ms]	Default	
6					
7					

4) Redo

[Steps]

1. Click the right mouse button to select [Redo].

Slot	Module	Comment	Input Filter	Emergency Output	Allocation
0	XGF-AV8A (Voltage, 8-CH)		-	-	
1					
2	DC 24V INPUT, 8points		3 Standard [ms]	-	
3	DC 24V INPUT/TR OUTP		3 Standard [ms]	Default	
4					
5	DC 24V INPUT/TR OUTP		3 Standard [ms]	Default	
6					
7					

## Chapter 9 Parameter

### Notes

- 20 steps are available for Undo and Redo functions.
- The shortcut keys used in I/O Parameters Edit can not be used as the user defined shortcut key specified in XG5000.
- One click of the mouse will select a single slot. In order to select lots of slots, drag the slot columns where the slot number is displayed as many as desired.

Slot	Module	Comment	Input Filter	Emergency Output	Allocation
0	XGF-AV8A (Voltage, 8-CH)		-	-	
1					
2	DC 24V INPUT, 8points		3 Standard [ms]	-	
3	DC 24V INPUT/TR OUTP		3 Standard [ms]	Default	
4	XGF-AV8A (Voltage, 8-CH)		-	-	
5	DC 24V INPUT/TR OUTP		3 Standard [ms]	Default	
6					
7					

### 9.2.4 Detailed Module Information Setting

How to set the detailed module information will be described. Double-click the mouse or click [details] button for the detailed module information setting.

#### 1) Input module

[Dialog Box]

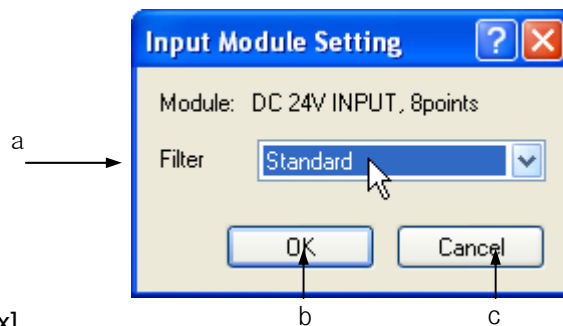

[Description of Dialog Box]

- Filter: used to specify the filter constant value for the input.
- OK: applies the specified details and closes the Dialog Box.
- Cancel: closes the Dialog Box.

Notes

- Input module with the input of AC can not specify the filter value.
- Standard value of the input filter shall be specified in basic parameters. Refer to 9.1 Basic Parameters for details on the Basic Parameters.
- The input filter used to inspect the input signal will process the applicable signal as normal input if kept identical for the filtering time. The figure below is with the input filter value of 3ms. As the input signal is kept identical for 3ms from the moment detected by specific level, it will be processed as normal input after 3ms.

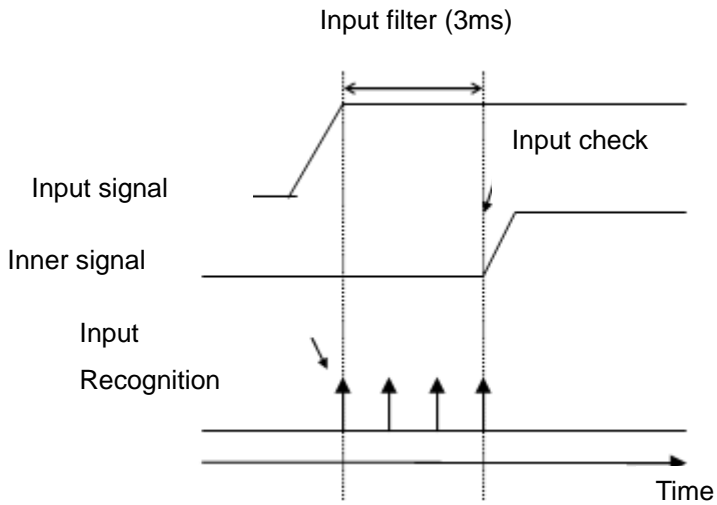



### 2) Output module

[Dialog Box]

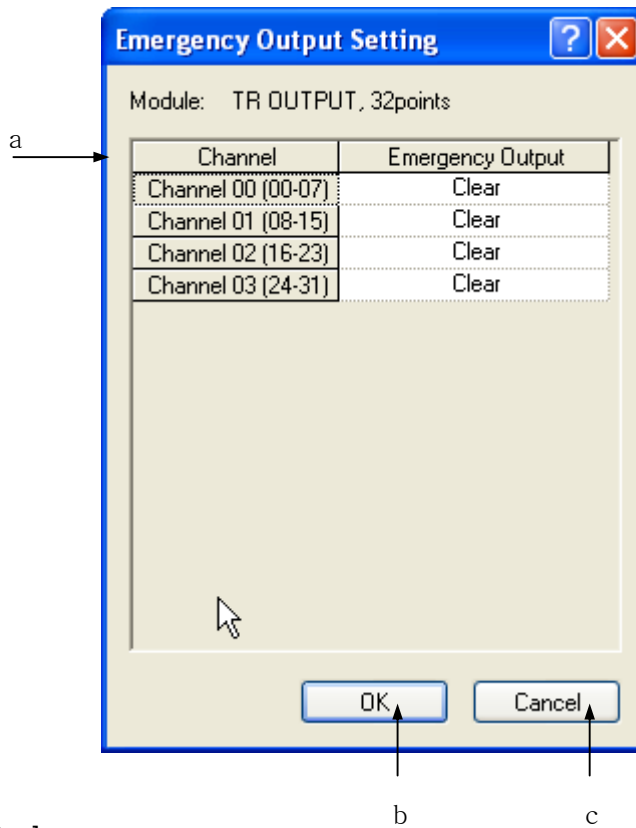

[Description of Dialog Box]

- a. Channel: one channel is assigned for 8 points, and the emergent output mode can be specified per channel.
- b. OK: applies the specified items and closes the Dialog Box.
- c. Cancel: closes the Dialog Box.

#### Notes

- Emergency output value will be specified like the stopped CPU during RUN.
- Default for the emergency output is Hold.

## 3) I/O module

[Dialog Box]

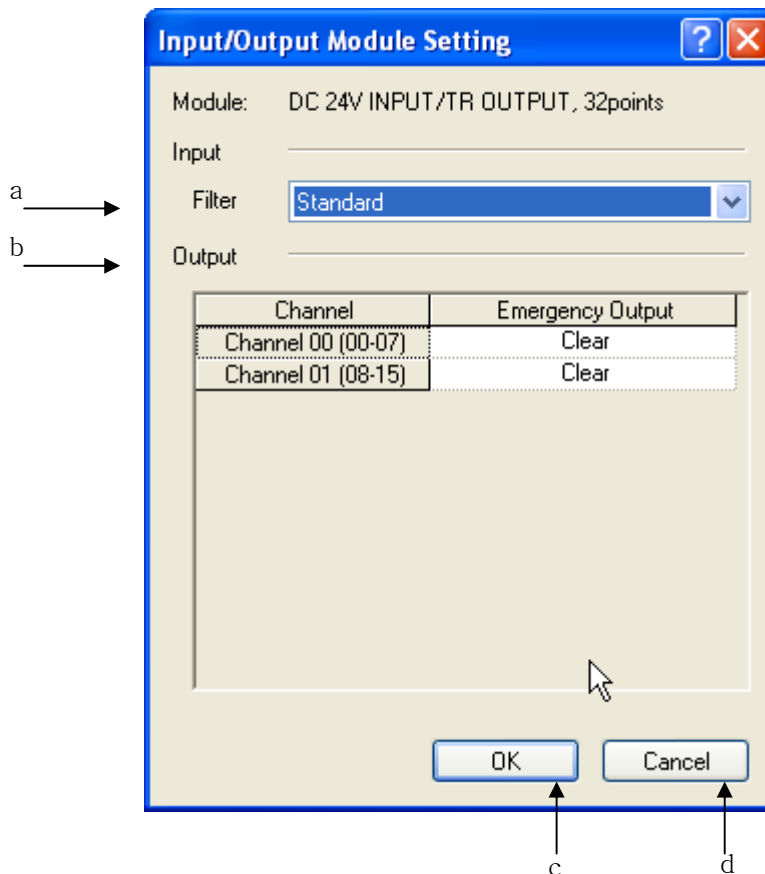

[Description of Dialog Box]

- a. Filter Value: used to specify filter constant value for the input.
- b. Output setting: used to specify detailed information for the output.
- c. OK: applies the changed items and closes Dialog Box.
- d. Cancel: closes Dialog Box.

**Notes**

- I/O module is mixed type of input module and output module. The input part has the characteristics identical to the input module, and the output part identical to the output module.

## 4) Module Reservation

It assigns the points of module only without any specific module specified. 16, 32 and 64 points are available for the assignment.

## Chapter 9 Parameter

### 5) A/D Module

On the I/O Parameter Setting Dialog box select A/D module and then click [Details] to display the Parameter Setting Dialog box as shown below.

[Dialog Box]

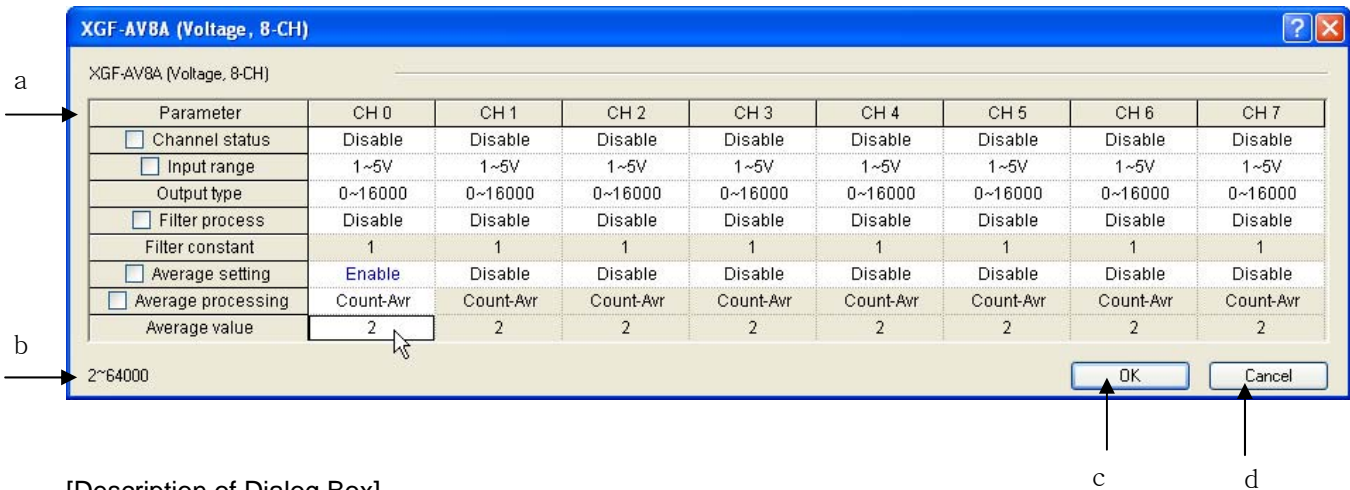

[Description of Dialog Box]

- All Parameters Settings: after the white check box selected on the left of the parameter names, if you change the parameter item value, all channels' applicable parameter value change.
- Maximum/Minimum Value Display: as for the parameter item to input figures, if the user inputs data, an applicable range will be displayed on the bottom of the dialog box automatically. If the user changes the parameter value to any other value than the default, the String color will change [Black]→[Blue].
- OK: applies the changed items and closes the dialog box.
- Cancel: closes the dialog box.

[Description of Parameter item]

Parameter	Setting Items	Default
Channels	Disable/Enable	Disable
Input Range	1~5V/0~5V/0~10V/-10~10V (Voltage Type) 4~20mA/0~20mA (Current Type)	1~5V 4~20mA
Output Type	0~16000/-8000~8000/1000-5000/0~10000% (Input range changes based on items)	0~16000
Filter Process	Disable/Enable	Disable
Filter Constants	1-99	1
Average Process	Disable/Enable	Disable
Average Method	Count Average/Time Average	Count Average
Average Value	Count Average 2-64000, Time Average 4-16000	2

Table 1. A/D Module Parameter Item

6) D/A Module

On the I/O Parameters Setting Dialog box, select D/A module and then click [Details] to display the Parameters Setting dialog box as shown below.

[Dialog Box]

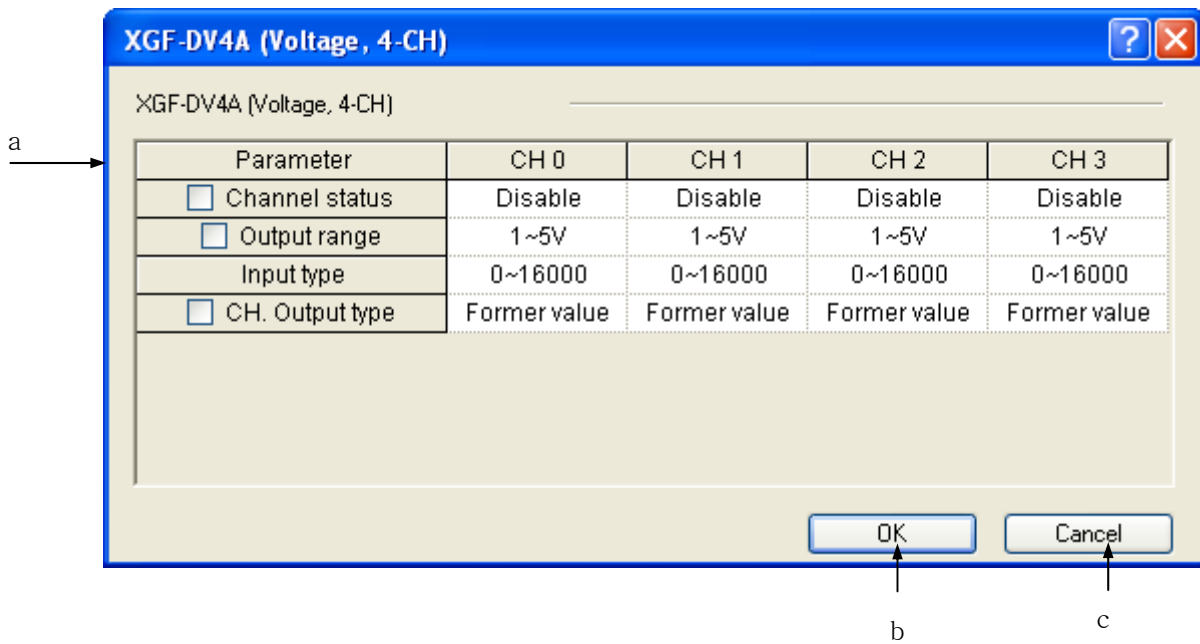

[Description of Dialog Box]

- a. All Parameters Settings: after the white check box selected on the left of the parameter names, change the parameter item value to change all channels' applicable parameter value. If the user changes the parameter value to any other value than the default, the String color will change [Black]→[Blue].
- b. OK: applies the changed items and closes the Dialog box.
- c. Cancel: closes the Dialog box.

[Description of Parameter item]

Parameter	Setting Items	Default
Channels	STOP/RUN	STOP
Output Range	1~5V/0~5V/0~10V/-10~10V (Voltage Type) 4~20mA/0~20mA (Current Type)	1~5V 4~20mA
Input Type	0~16000/-8000~8000/1000-5000/0~10000% (changed based on output range)	0~16000
Channel Output Type	Previous/minimum/middle/maximum Value	Previous Value

Table 1. D/A Module Parameter Item

## Chapter 9 Parameter

### 7) High-speed Counter Module

On the I/O Parameters Setting Dialog box, select High Speed counter module and then click [Details] to display the Parameters Setting Dialog Box as shown below.

[Dialog Box]

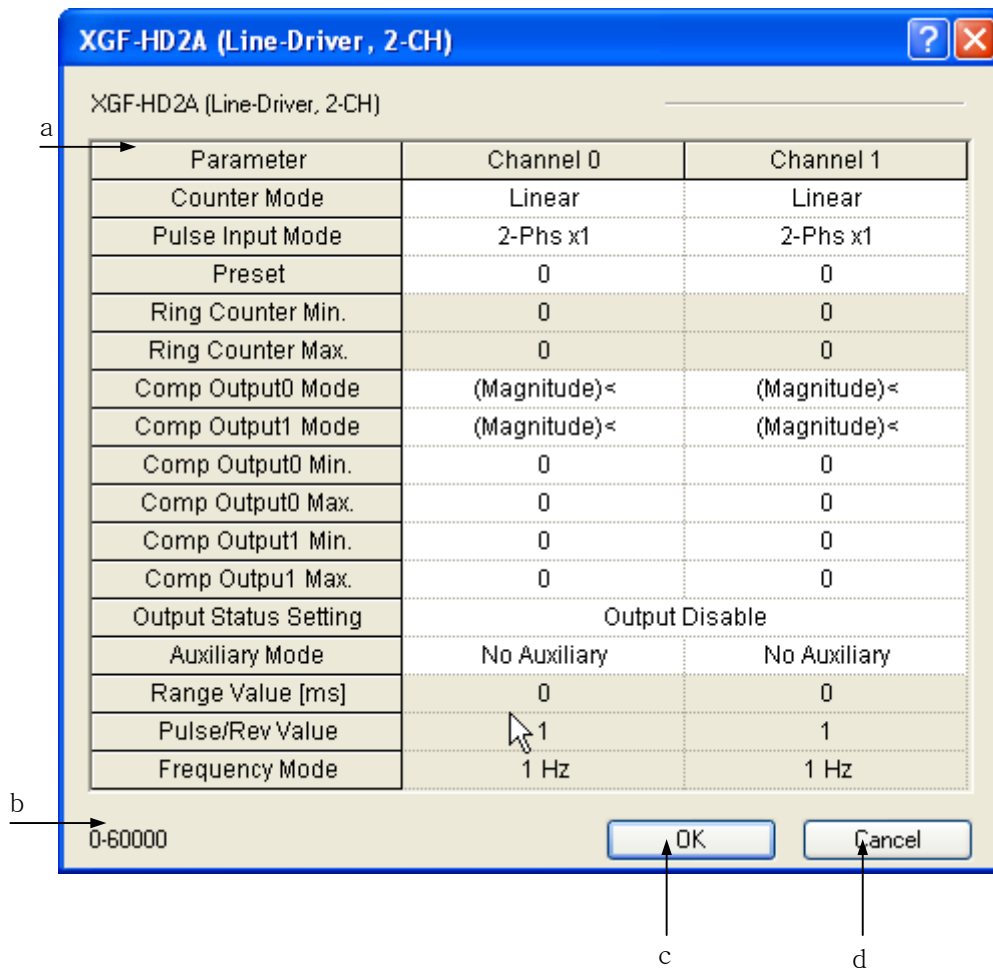

[Description of Dialog Box]

- a. Parameter Area: displays the parameter item. And if the user changes the parameter value to any other value than the default, the String color will change [Black]→[Blue].
- b. Maximum/Minimum value Display: as for the parameter item to input figures, if the user inputs data, an applicable range will be displayed on the bottom of the dialog box automatically.
- c. OK: applies the changed items and closes the Dialog Box.
- d. Cancel: closes the Dialog Box.

[Description of Parameter items]

Parameter	Setting Items	Default
Counter Mode	Linear Counter/Ring Counter	Linear Counter
Pulse Input Mode	2-phase 1-multiplier/2-phase 2-multiplier/ 2-phase 4-multiplier/CW-CCW/ 1-phase 1-input 1-multiplier/ 1-phase 1-input 2-multiplier/ 1-phase 2-input 1-multiplier/1-phase 2-input 2-multiplier	2-phase 1-multiplier
Additional Function Mode	N/A/Count clear/Count latch/ Sampling count/Measure input frequency / Measure rotations per unit time/Count Disable	N/A
Range Value [ms]	0-60000	0
Compared Output 0 Mode	(Single Compare) less/(Single Compare) less or equal/ (Single Compare) equal/(Single Compare) equal or greater/ (Single Compare) greater/(Section Compare) included/ (Section Compare)excluded	(Single Compare) less
Compared Output 1 Mode	As identical as specified above	(Single Compare) less
Preset Input Value	-2147483648-2147483647	0
Ring Counter, Minimum Value	-2147483648-2147483647	0
Ring Counter, Maximum Value	-2147483648-2147483647	0
Compared Output 0 Minimum Setting Value	-2147483648-2147483647	0
Compared Output 0 Maximum Setting Value	-2147483648-2147483647	0
Compared Output 1 Minimum Setting Value	-2147483648-2147483647	0
Compared Output 1 Maximum Setting Value	-2147483648-2147483647	0
Number of Pulses per Rotation	0-60000	0
Frequency Display mode	1Hz/10Hz/100Hz/1000Hz	1Hz

Table 1. HS Counter Parameter Items

### Notes

- "Pulse/Rev value" item among High-speed counter parameter items will be active when the Auxiliary Mode is set to "Revolution/Unit time".

### Notes

- Refer to APM manual for details on the positioning module.
- Refer to XG-PD manual for details on the communication module.

### 9.2.5 I/O Parameter Print Function

This function is used to print the specified I/O parameter and detailed module information specified.

#### 1) Print Option Setting

[Steps]

1. On I/O Parameter Dialog Box, select [Print Button]-[Print].

[Dialog Box]

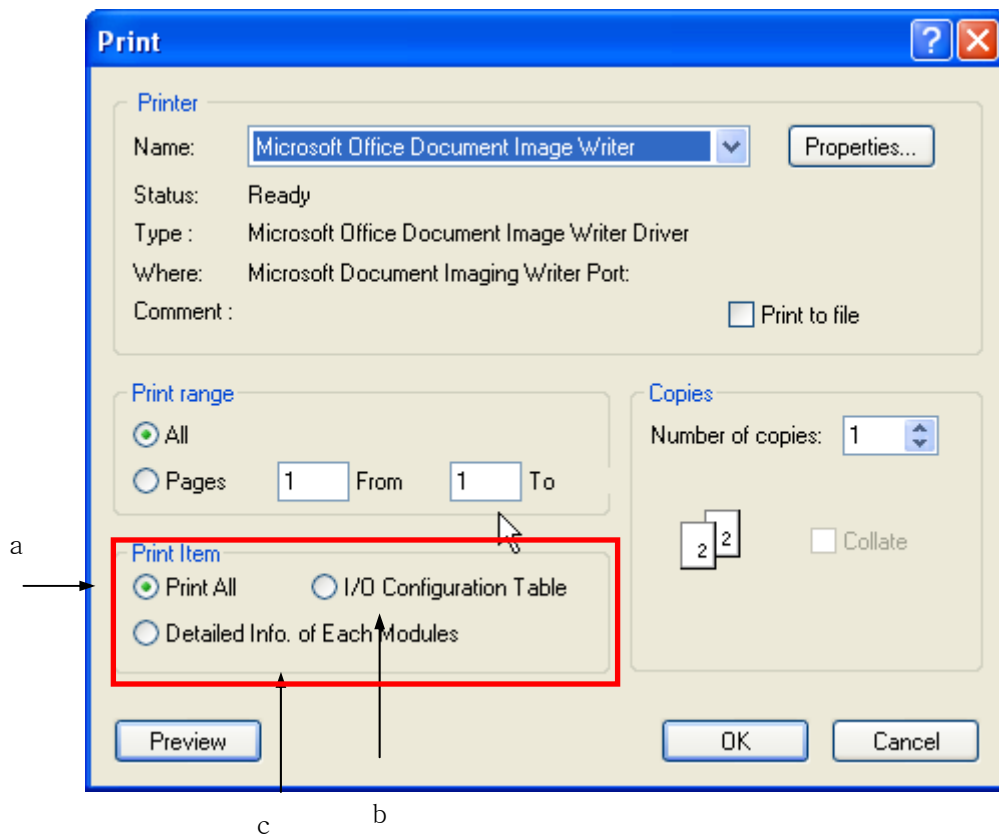

[Description of Dialog Box]

- a. Print All: prints all I/O configuration table and detailed module information.
- b. I/O Configuration Table: prints I/O parameter's module setting details based on slots, description and I/O information assigned.
- c. Detailed Info. of Each Modules: prints the detailed module information for specified slot module.

### 2) Print Preview

[Steps]

1. Select [Print Button]-[Print] on the I/O Parameter Dialog Box.
2. Click [Preview] on the [Print Dialog Box].

### 3) Copy to Clipboard

It is used to print the I/O parameter table to the clipboard, thus to add onto the String editor, word processor or spread sheet.

[Steps]

1. Select [Print Button]-[Copy to Clipboard] on the I/O parameter Dialog Box.

#### Notes

- While printing clipboard, the print options are not available but always I/O configuration table only available to print.



## Chapter 10 Online

Available functions only with PLC connected will be described below.

### 10.1 Connect Options

It is used to specify the connection network with PLC.

#### 10.1.1 Local Connect Setting

RS-232C or USB connection is available for Local Connect Setting.

1. Select [Online]-[Connect Settings] on the menu.

[Dialog Box]

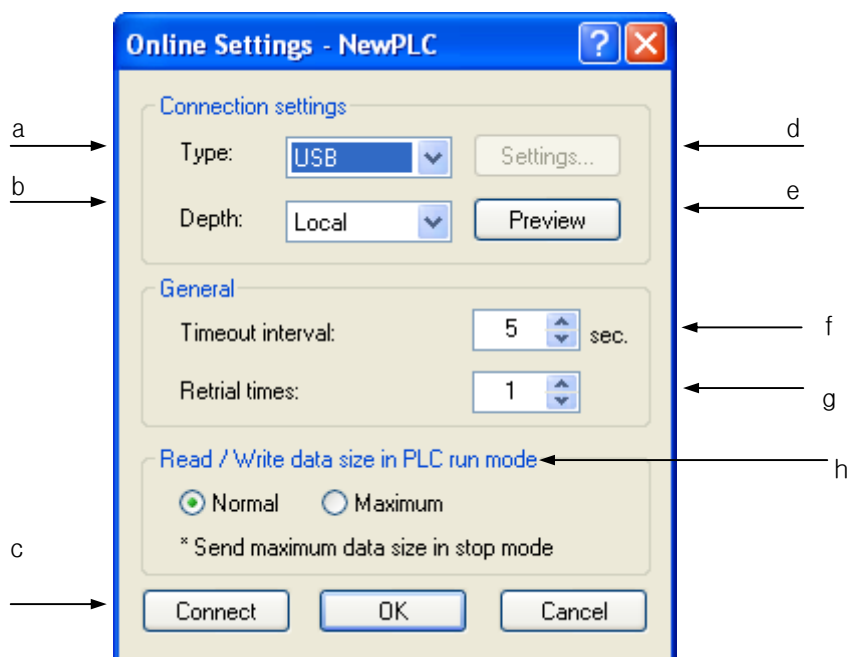

[Description of Dialog Box]

- a. Type: used to specify communication media when PLC is connected. RS-232C, USB, Ethernet and Modem are available to set.

- b. Depth: used to specify the connection configuration with PLC. Local, Remote 1 and Remote 2 are available to set.
- c. Connect: tries to connect to PLC as specified in Connect options.
- d. Settings: allows detailed setting based on a. Connection Type selected.
- e. Preview: used to see all Connect Options at a glance.
- f. Timeout interval: Time-out occurs to retry to connect if the communication connection to PLC is not resumed within the specified time.
- g. Retrial times: used to specify the times to retry to connect with PLC if the communication connection fails.
- h. Read/Write data size in PLC run mode: used to specify the frame size of data to transfer. This option is available only when the PLC operation is in Run mode. In other operation modes, data will be transferred in the maximum frame size.

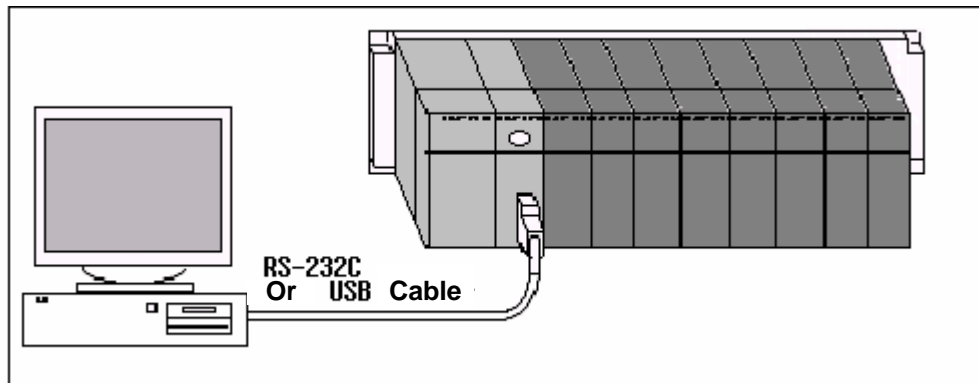

### 1) Connection of Local RS-232C

[Steps]

1. Select the Connection Type of RS-232C.
2. Click the setting button to specify communication speed and communication COM port.
3. Click [OK] to save the Connect Options..

[Dialog Box]

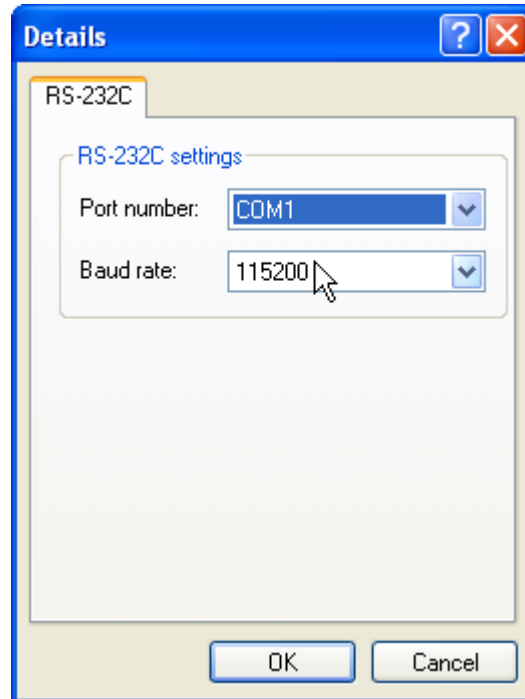

#### Notes

- Default is RS-232C COM1 with the communication speed of 115200bps.
- 38400bps and 115200bps available for communication speed.
- Communication speed is 115200bps for XGT Series, and 38400bps for remote connection via Rnet.
- Communication ports of COM1 ~ COM8 are available.
- If USB serial device is used, a virtual COM port will be applied to the communication port. Check the device administrator to ensure the specified port number.
- Connection in XG5000 and Connection in XG-PD, device monitor and system monitor are available with one PLC at the same time. However, it shall be of identical Connect Options.

#### 2) Connection of Local USB

1. Select the Connection Type of USB.
2. USB has no detailed setting options. Thus the setting button is inactive.
3. Click [OK] to save the Connect Options.

### Notes

- USB device driver has to be installed for USB to connect to PLC. If not, let it installed prior to the connection.
- When XG5000 is installed, USB driver will be installed automatically. If USB driver is not normally installed, download the applicable driver from LSIS Home Page to install.

### 10.1.2 Remote 1 Connect Setting

#### 1) Ethernet Connect Setting

[Steps]

1. Select the Connection Type of Ethernet.
2. Click the setting button to specify Ethernet IP.
3. Click [OK] to save the Connect Options.

[Dialog Box]

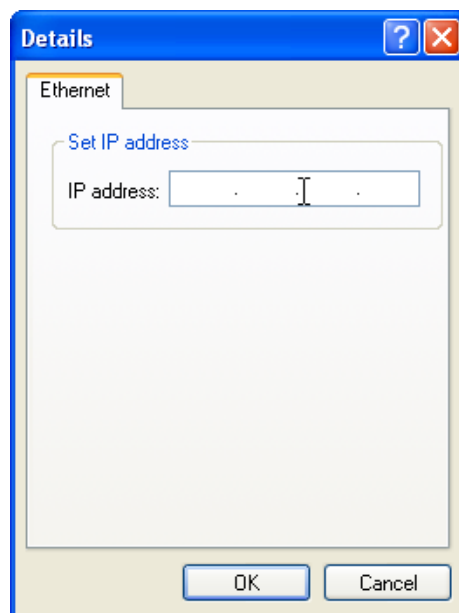

### Notes

- Ethernet shall be connected with PC to connect to Ethernet.
- IP is as specified in Ethernet communication module.
- Use Ping in [Execute] on Windows start menu previously to ensure normal connection is allowed with the specified IP.

## 2) Modem Connect

1. Select the Connection Type of Modem.
2. Click the setting button to specify modem details.

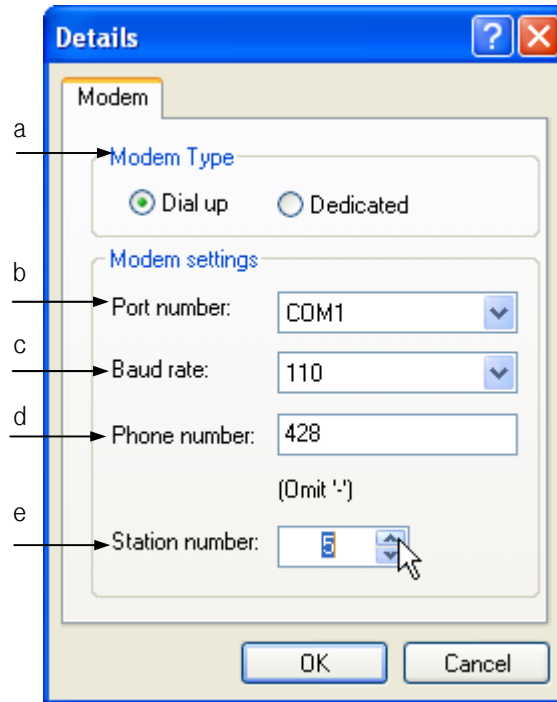

[Dialog Box]

## [Description of Dialog Box]

- a. Modem Type: specifies the modem type available to connect. Cnet communication module has the exclusive modem functions.
- b. Port number: specifies modem's communication port.
- c. Baud rate: specifies modem's communication speed.
- d. Phone number: used to input modem's number of phone if it's dial-up modem.
- e. Station number: used to input the station Number specified in the communication module of Remote Step

## 3) RS-232C or USB Remote Connect

## [Steps]

1. Select the Connection Type of RS-232C.
2. Select the Connection Step of Remote 1.
3. Click the setting button to specify Remote 1.

[Dialog Box]

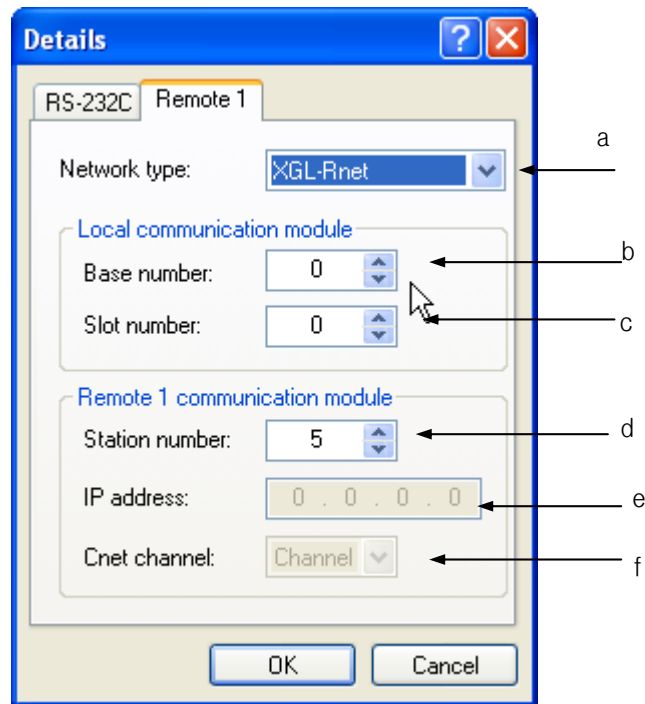

[Description of Dialog Box]

- a. Network type: used to specify PLC communication module type for remote connection. Rnet, Cnet, FEnet and FDEnet are available for the communication modules
- b. Base number: used to specify communication module's base number of local PLC base.
- c. Slot number: used to specify communication module's slot number of local PLC base.
- d. Station number: used to input communication module's specified station Number of Remote 1.
- e. IP address: used to input communication module's specified IP address of Remote 1.
- f. Cnet channel: Select the connection channel port if the communication module of Remote.1 connection is Cnet module

### Notes

- Only if the network type is FEnet, IP address will be active. If not, IP address will be inactive with the Station number active
- Base number of 0~7 and slot number of 0~11 is available.

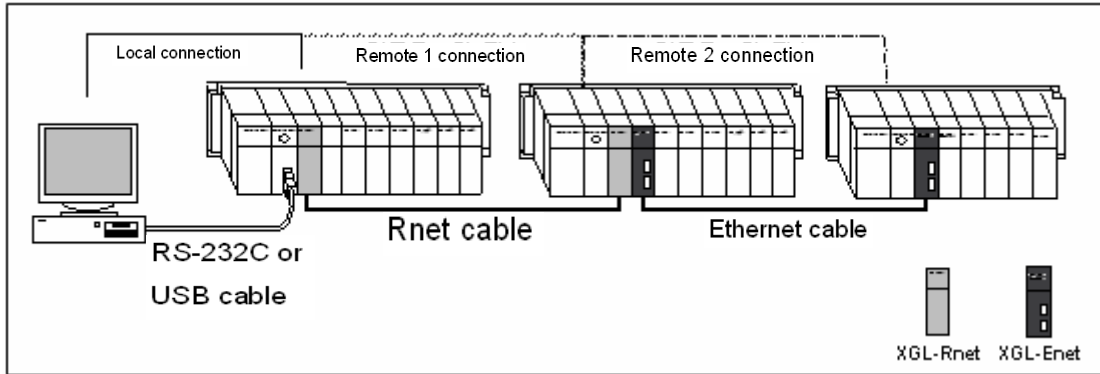

### 10.1.3 Remote 2 Connect Setting

[Dialog Box]

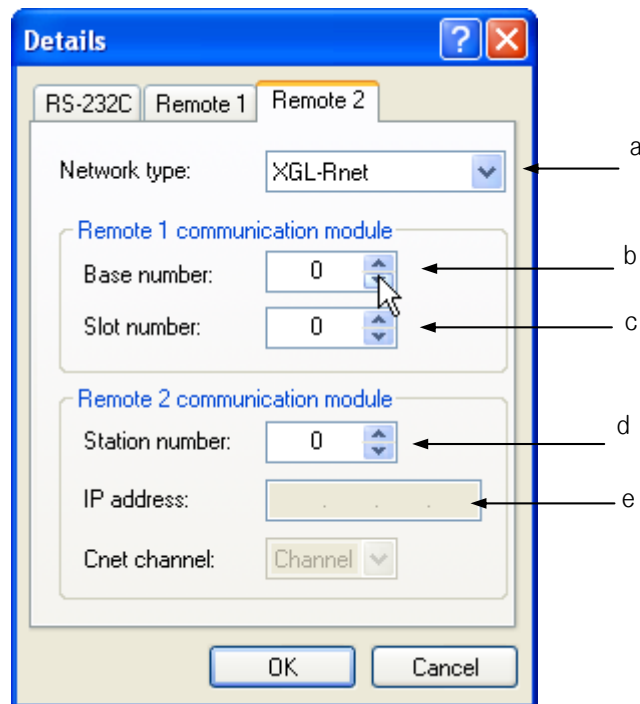

[Description of Dialog Box]

- a. Network type: used to specify PLC communication module type for remote connection. Rnet, Cnet, FEnet and FDEnet are available for the communication modules
- b. Base number: used to specify communication module's base number of local PLC base.
- c. Slot number: used to specify communication module's slot number of local PLC base.
- d. Station number: used to input communication module's specified station Number of Remote 1.
- e. IP address: used to input communication module's specified IP address of Remote 1.



## 10.2 Connect/Disconnect

### 10.2.1 Connect

It tries to connect to PLC based on the specified Connect Options.

[Steps]

1. Select [Online]-[Connect] on the menu.
2. The Dialog Box will appear while connecting.

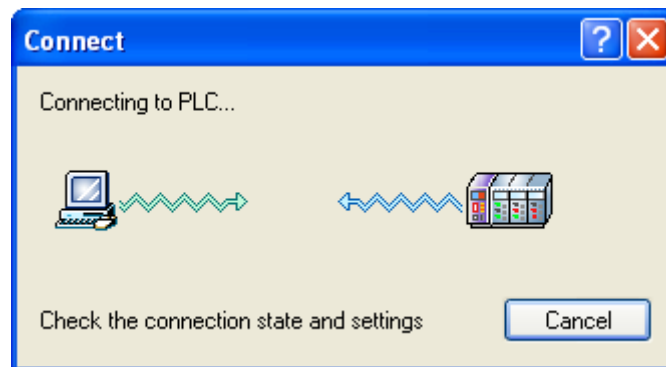

3. If connected to PLC, the Online menu and Online status will be displayed.
4. If password is setup in the PLC, Password input dialog will be displayed.

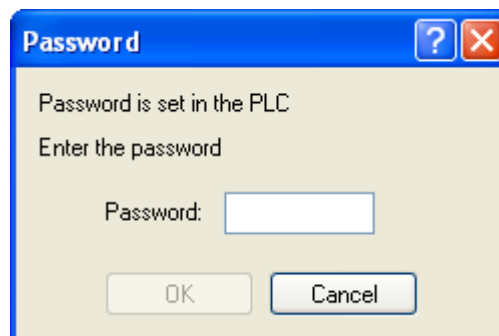

5. Connection will be established if the input password is match with the PLC password.

### Notes

- If connected to PLC fast, the Dialog Box may appear and disappear quickly while connecting.
- After connected, PLC's status will be displayed at the side of project name on the project window and on the status display line.

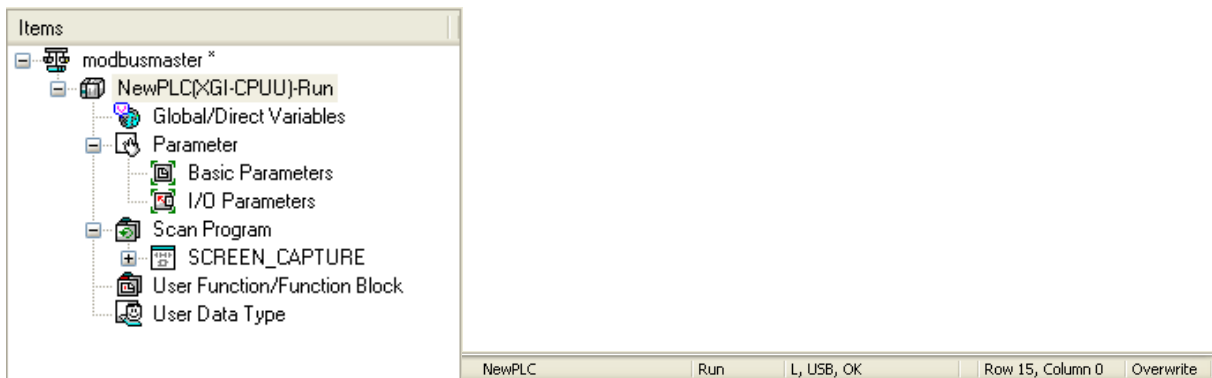

If any other application program is already connected while PLC connected, its main Online functions are unavailable.

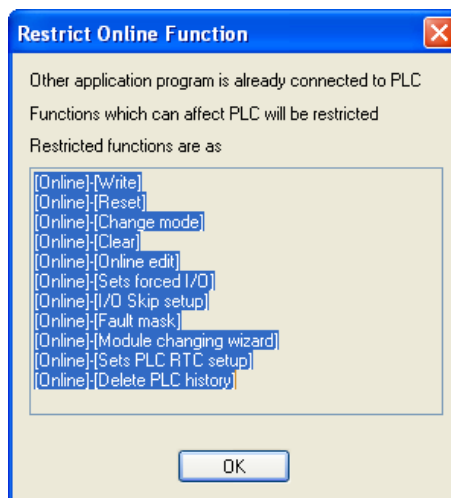

- After PLC connected, connecting its cable to other PLC with different type will make the former PLC disconnected automatically.
- When Disconnect is executed, Monitor and Debug functions will be also ended.

## Notes

-Check Points when connection is failed.

## 1) RS-232C

- Check if RS-232C cable connection between Computer and PLC is correct
- Check if the number of COM port of computer is match with the number of COM port where the cable is connected.
- Check if the link of RS-232C cable is correct.
- Check if the status of PLC is normal.

## 2) USB

- Check if USB cable connection between Computer and PLC is correct
- Check if the computer found the PLC as an USB device correctly.
  - a) Connect the computer and PLC with USB cable.
  - b) Click [Control Panel]-[System]-[Hardware Tab]-[Device Manager].
  - c) Check if the computer found the PLC as an USB device correctly in the [Device Manager] dialog box.
  - d) If there is “yellow exclamation mark” or “Unknown Device”, it means that the computer have not found the driver file for connected device.

\* Abnormal connection state

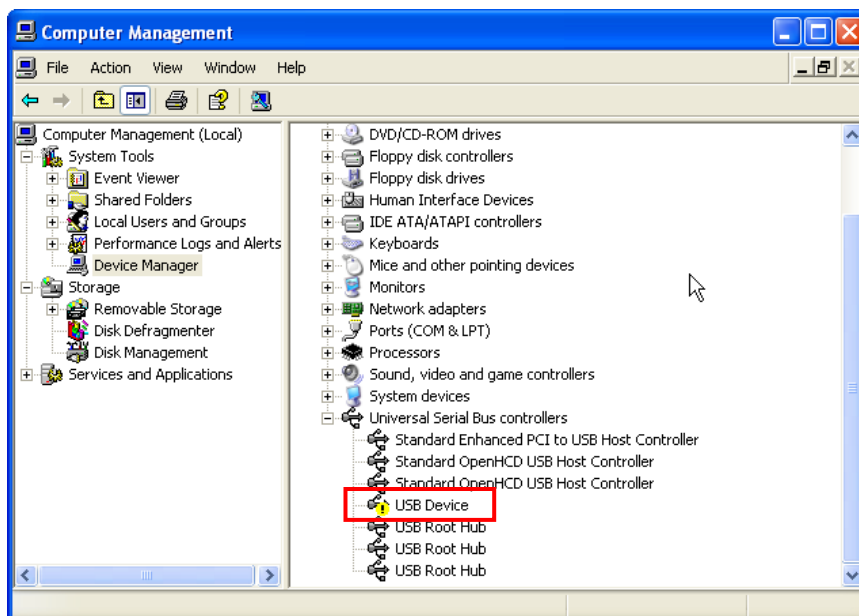

\* Normal connection state

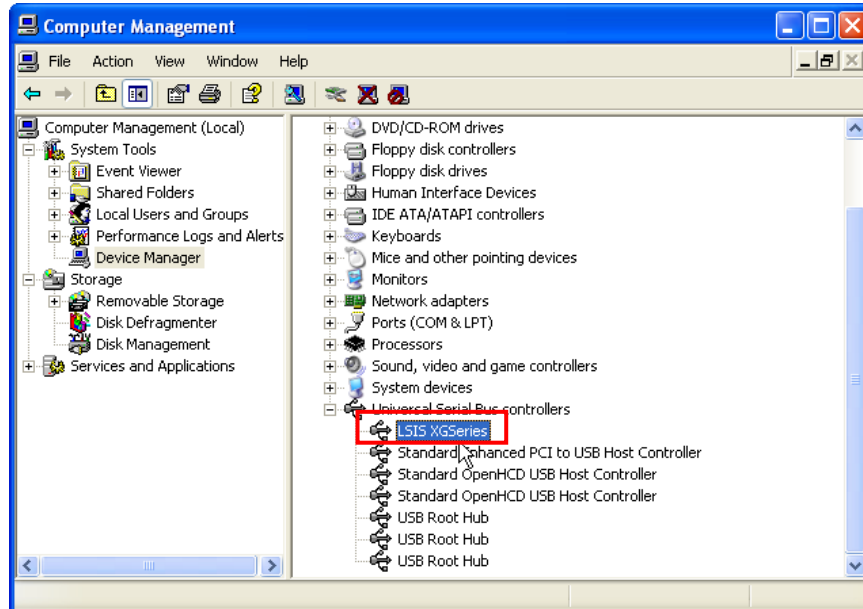

### 3) Ethernet

- Check if Ethernet cable (LAN cable) connection between Computer and PLC is correct.
- Check if the IP and Gateway of Ethernet module is correct. The IP and Gateway of Ethernet module can be read or written with XG-PD software, which can be executed when [Tools]-[Network Manager] on the XG5000 menu bar is clicked.
- Check if the Ethernet module responds correctly, if the IP and Gateway of Ethernet module is correct.
  - a) Click "Execute" which can be seen when Start button of Windows is clicked.
  - b) Input "command" in the Execute dialog box

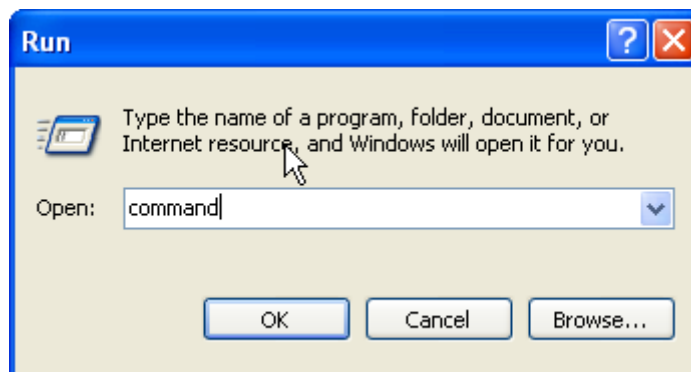

- c) Execute ping test for Ethernet module in the Command Prompt. Type "ping IP address" and press 'Enter' key. If the Ethernet module responds normally, the screen will show the communication status as below. And if the Ethernet module does not respond, the screen will show "Time out"

message.

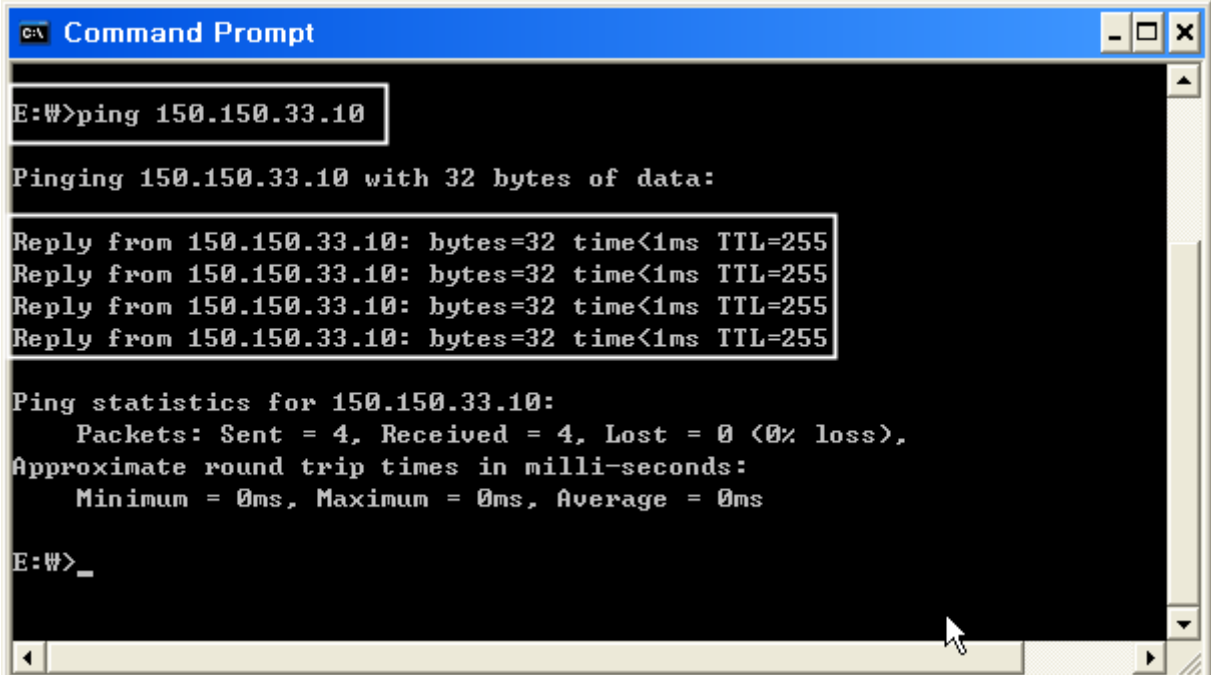

```
C:\ Command Prompt
E:\W>ping 150.150.33.10
Pinging 150.150.33.10 with 32 bytes of data:
Reply from 150.150.33.10: bytes=32 time<1ms TTL=255
Reply from 150.150.33.10: bytes=32 time<1ms TTL=255
Reply from 150.150.33.10: bytes=32 time<1ms TTL=255
Reply from 150.150.33.10: bytes=32 time<1ms TTL=255

Ping statistics for 150.150.33.10:
    Packets: Sent = 4, Received = 4, Lost = 0 (0% loss),
    Approximate round trip times in milli-seconds:
        Minimum = 0ms, Maximum = 0ms, Average = 0ms

E:\W>_
```

- Check if the status of PLC is normal.

### 10.3 Write

It is used to transfer user programs, respective parameter and comment to PLC.

[Steps]

1. Select [Online]-[Connect] to connect to PLC via Online.
2. Select [Online]-[Write].
3. Select the data to transfer to PLC and then click [OK] to start to transfer the selected data to PLC.

[Dialog Box]

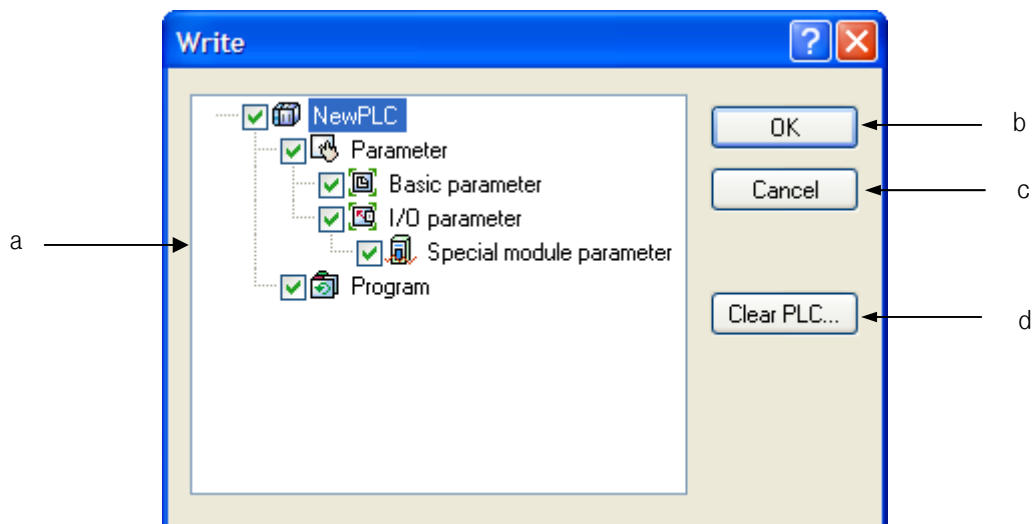

[Description of Dialog Box]

- a. Selection Tree: selects the data to transfer to PLC.
- b. OK: starts to transfer the data to PLC if clicked.
- c. Cancel: cancels to write data.
- d. Clear PLC: recalls dialog box to clear internal memory area, parameter and program  
(For more detail, refer to '10.8 Clear PLC')

### – Notes

- XGI/XGR retain area device holds previous value though you write the program. In order to initialize the retain area, execute 'Clear PLC' function to clear the area you want
- For description on data retain area, refer to each CPU user manual .

[Dialog Box]

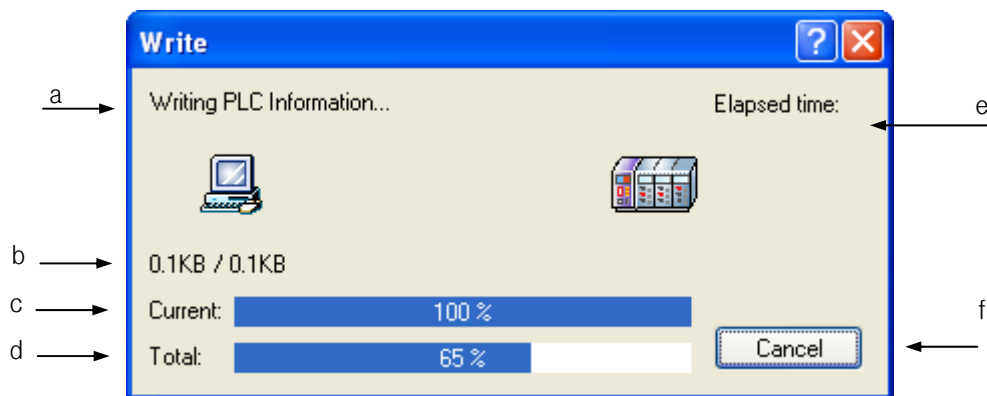

[Description of Dialog Box]

- Displays the present Write/Read item in progress.
- Displays the data size of the item (present item's size/ all items' size)
- Displays progressing rate of the present item.
- Displays progressing rate of all items.
- Displays progressing time elapsed till present.
- Cancel: Stops transferring the data.

### Notes

- The special module parameter Write is available only when I/O parameter Write is selected.
- Modification Write time during Run will take much longer than during Stop.

### 10.4 Read

It is used to upload programs, respective parameter and comment saved in PLC to apply to the present project.

[Steps]

1. Select [Online]-[Connect] to connect to PLC.
2. Select [Online]-[Read].
3. Click [OK] after items to upload from PLC are selected. The uploaded items will be applied to the present project.

#### Notes

- Refer to 10.3 Write for comment of each Dialog.
- It is not possible to exclusively read rung comment/output comment which are read as Read Program.



## 10.5 Change Mode

It is used to convert PLC operation mode.

[Steps]

1. Select [Online]-[Connect] to connect to PLC.
2. Select [Online]-[Change Mode]-[Run/Stop/Debug].
3. PLC operation mode will change as selected by the user.

### Notes

- PLC's remote dip switch shall be ON with the operation mode dip switch in Stop.
- The program in PLC shall be identical to that in the project to convert to Debug mode.
- If converted from Stop to Run mode, a Dialog Box will appear to inform that the program is being converted to an executable code inside PLC. This Dialog Box may not be closed for up to 30 seconds according to the program size.
- If converted to Run mode, the following Dialog Box will appear while initialization task is executed. After the initialization task is over or disconnected, the Dialog Box will disappear.

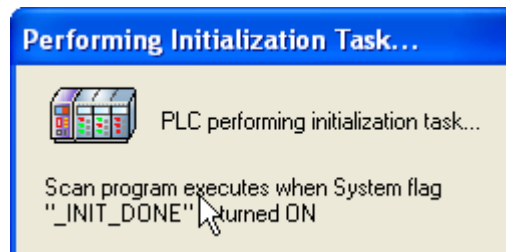

- If converted to Run or Debug mode, Run or Debug function will not be normal if any error occurs on PLC. Delete the PLC error first and then convert the operation mode.
- If Show Message when changing the PLC mode in the [Tool]-[Option]-[Online] is unchecked, the confirm message will not displayed when Mode Change instruction is executed.

## 10.6 Compare to PLC

It compares the project in PLC to the project open in XG5000.

[Steps]

1. Select [Online]-[Connect] To connect to PLC.
2. Select [Online]-[Compare with PLC].
3. Select an object to compare and then click [Compare].

[Dialog Box]

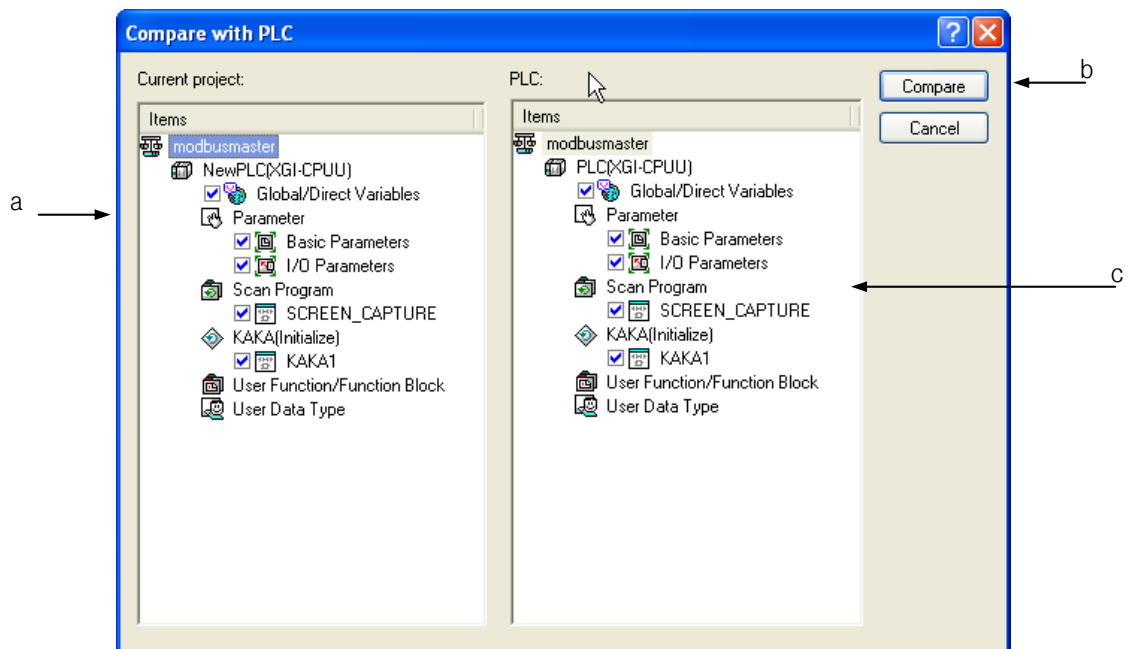

[Description of Dialog Box]

- a. Current project: means the project open in XG5000.
- b. Compare: compares between the selected items.
- c. Project to compare: means the project inside PLC.

### Notes

- The result of Compare is identical to the menu [Project]-[Compare Project].
- Refer to 'Compare Project' for detailed result of Compare.

## 10.7 Reset PLC

It is used to reset PLC. Reset PLC is also available with 'Reset PLC' dip switch.

[Steps]

1. Select [Online]-[Connect] to connect to PLC.
2. Select [Online]-[Reset PLC].
3. After reset type selected, click [OK] button to reset PLC.

[Dialog Box]

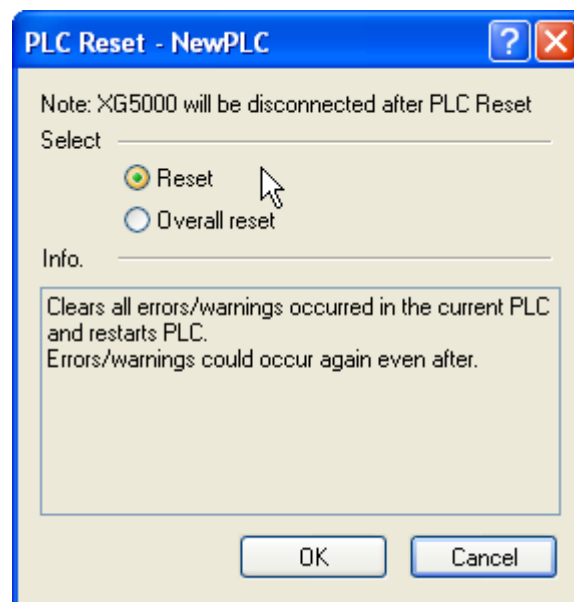

### Notes

- Reset and Overall reset are available for its type.
- Reset: when PLC powered back, it will delete error/warning information to allow power on. Error/warning may occur continuously based on the situation.
- Overall reset: when PLC powered back, it will delete error/warning information, latch 1 area data, I/O skip, error mask and forced I/O setting area to allow power on..
- Be careful! PLC after reset will be off and then on again.

## 10.8 Clear PLC

It deletes programs, respective parameter, comment, and memory and latch area in PLC.

[Steps]

1. Select [Online]-[Connect] to connect to PLC.
2. Select [Online]-[Clear PLC].
3. Select items to delete and then click Clear to start Clear PLC.

### 10.8.1 Clear Item

It deletes the contents of the project saved in PLC.

[Dialog Box]

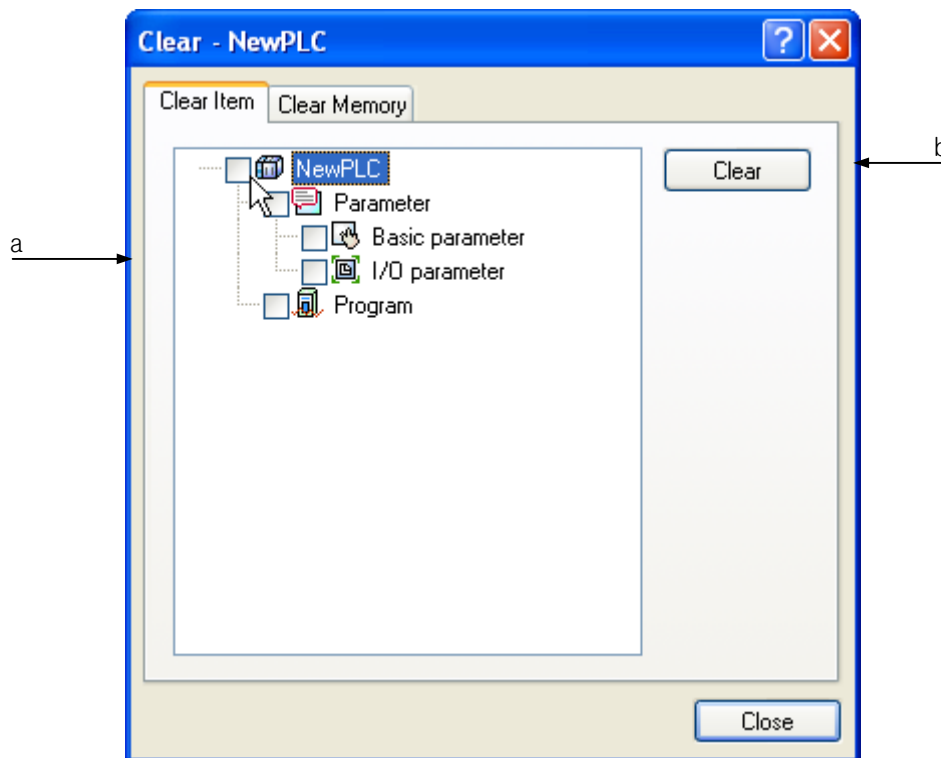

[Description of Dialog Box]

- List of items to select: shows the items saved in PLC.
- Clear: deleted the selected items.

## 10.8.2 Clear Memory

It deletes the memory value in PLC.

[Dialog Box]

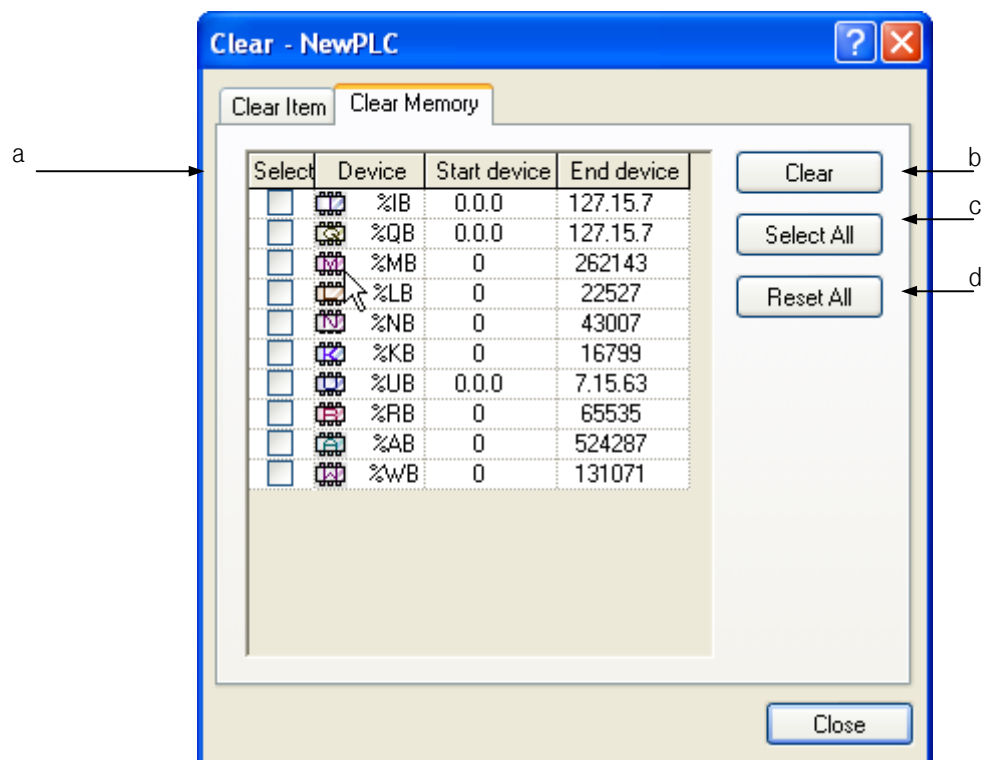

[Description of Dialog Box]

- List of memory areas to select: shows the memory areas in PLC. Start/End address to delete can be specified by the user.
- Clear: deleted the selected items.
- Select All: selects all the memory areas.
- Reset All: cancels all the memory areas selected.

### 10.9 PLC Information

It shows the information of PLC connected, where password and PLC timer can be set.

#### 10.9.1 CPU Information

Detailed information of PLC CPU can be checked.

[Steps]

1. Select [Online]-[Connect] to connect to PLC.
2. Select [Online]-[PLC Information].
3. Select the CPU tap.

[Dialog Box]

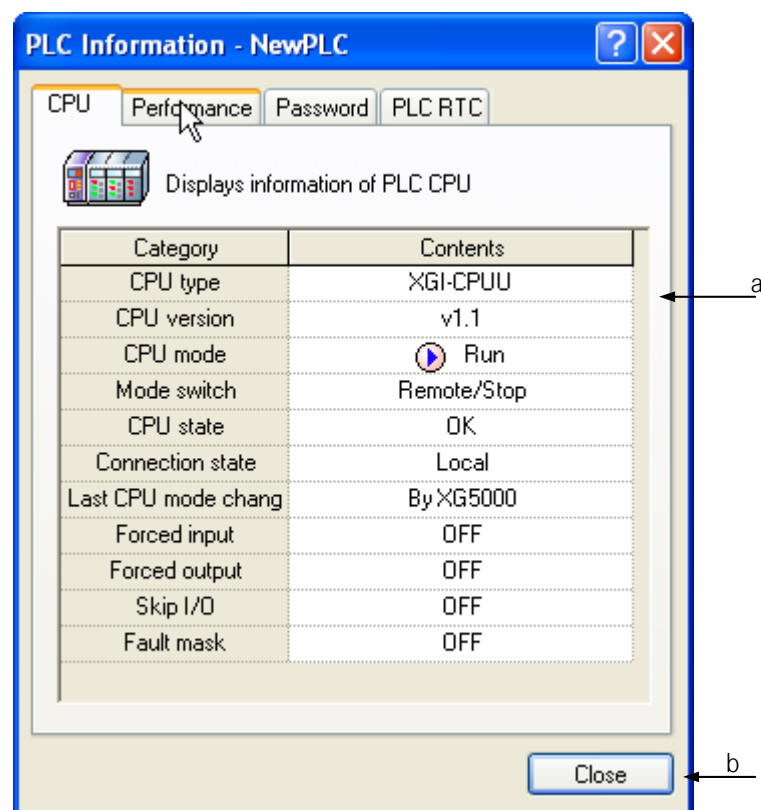

[Description of Dialog Box]

- a. Shows the specified details and status of the connected PLC CPU.
- b. Close: Close the dialog box.

## 10.9.2 CPU Performance

Scan time of PLC and memory application status can be checked.

[Steps]

1. Select [Online]-[Connect] to connect to PLC.
2. Select [Online]-[PLC Information].
3. Select the Performance tap.

[Dialog Box]

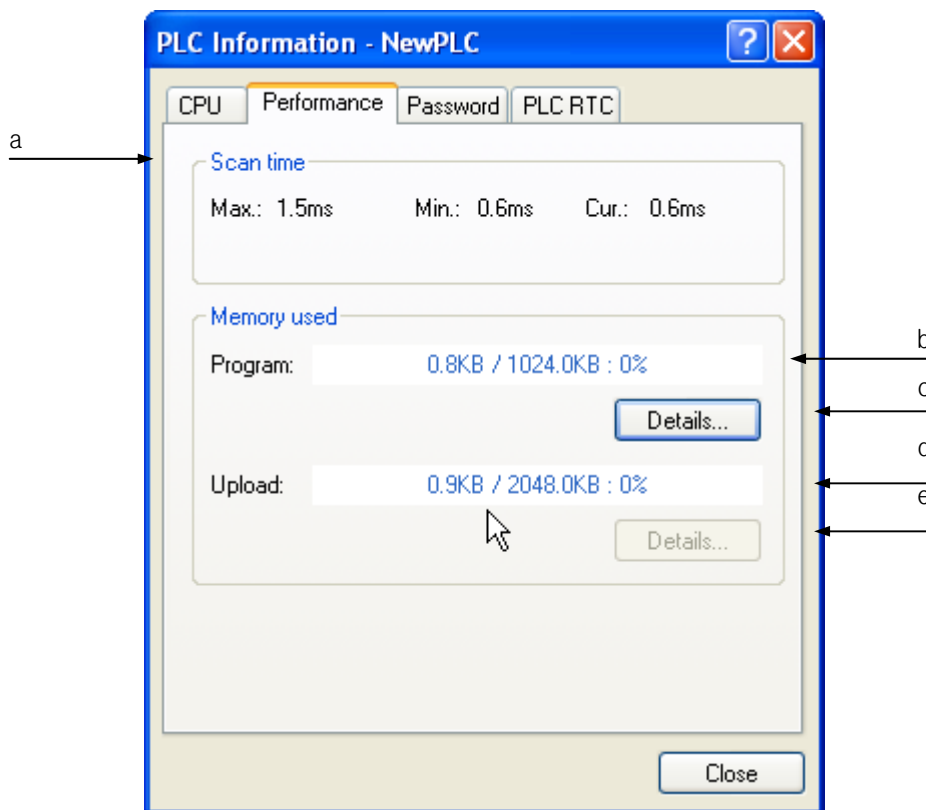

[Description of Dialog Box]

- a. Scan Time: shows the Maximum/Minimum/Current scan time of PLC connected. If [Fixed Cycle Operation] is set in the basic parameter, it displays the fixed cycle.
- b. Program Memory used: shows the downloaded programs' size/ all PLC program areas' size.
- c. Details: shows the list of programs downloaded on PLC.
- d. Comment Memory used: shows the downloaded comment's size/ all PLC comment areas' size.
- e. Details: shows the list of comments saved in PLC.

[Dialog Box]

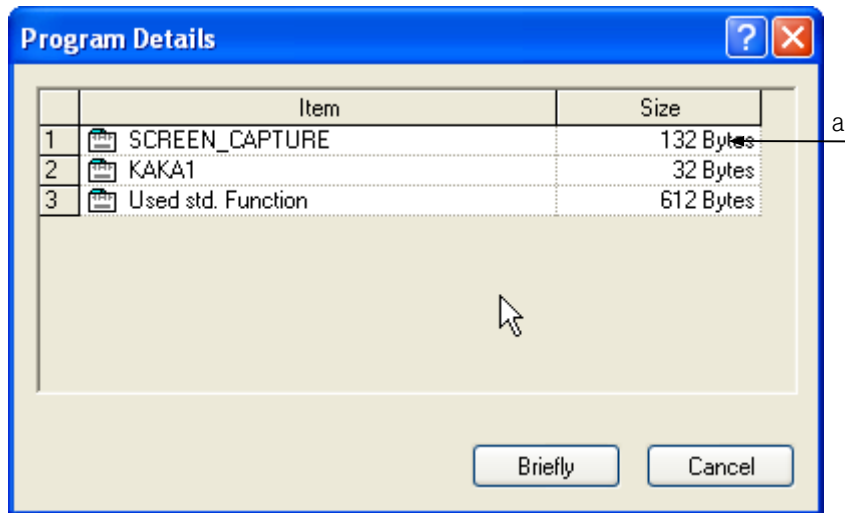

[Description of Dialog Box]

- a. List: shows the list and size of the programs saved



### 10.9.3 Password

User password can be specified, changed or deleted to protect PLC information.

[Steps]

1. Select [Online]-[Connect] to connect to PLC.
2. Select [Online]-[PLC Information].
3. Select the Password tap.

[Dialog Box]

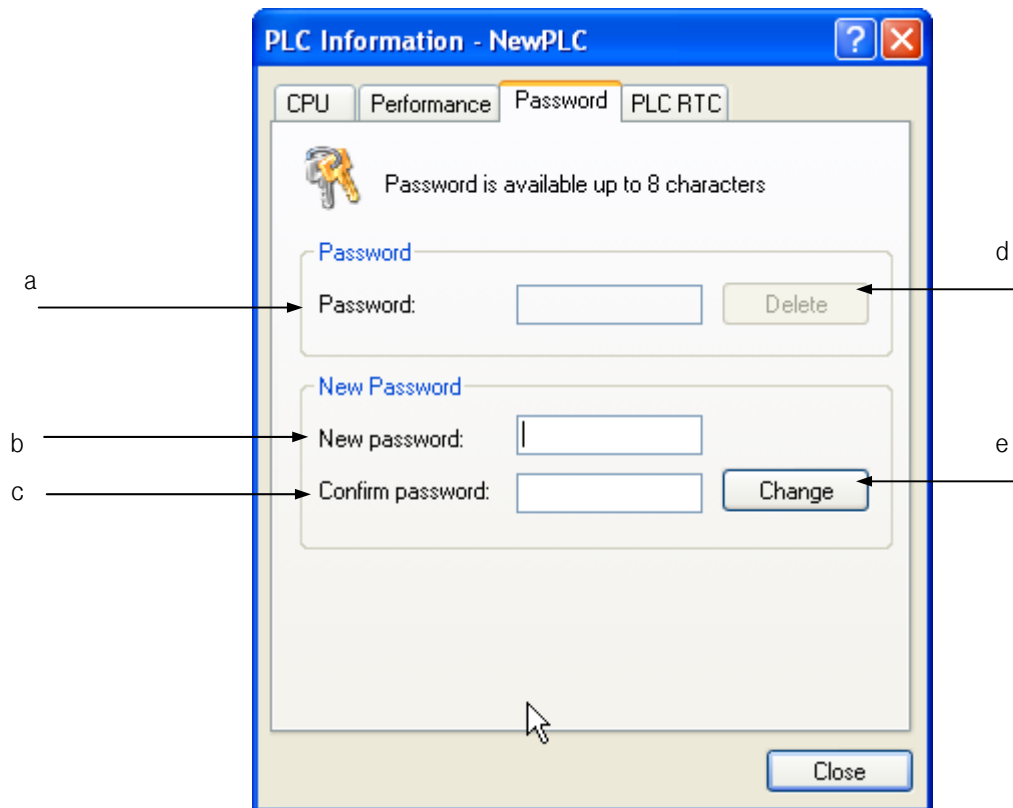

### [Description of Dialog Box]

- a. Current Password: used to input the password saved in PLC.
- b. New password: used to input a new password.
- c. Confirm password: used to input the New Password again.
- d. Delete: deletes the password of PLC.
- e. Change: changes the password of PLC.

### [Password Setting]

1. Input a new password in Edit Box 'b' for New Password Input.
2. Input the new password again in Edit Box 'c' for Confirm password as identical as in 1 above.
3. Click Change button 'e' to set the new password in PLC.

### [Password Changes]

1. Input the password saved in PLC in Edit Box for current Password Input.
2. Input a new password in Edit Box 'b' for New Password Input.
3. Input the new password again in Edit Box c for Confirm password as identical as in 2 above.
4. Click Change button 'e' to change the password of PLC.

### [Password Delete]

1. Input the password saved in PLC in Edit Box for current Password Input.
2. Click Clear d to delete the password of PLC.

### Notes

- Up to 8 letters is available for the password.
- Letters used as password will be classified into capital or small.
- Special letters can be used for password.
- If password is setup in the PLC, the PLC asks the password when connection is tried and the PLC permit to connection when password is correct.

### 10.9.4 PLC RTC Setting

The RTC (Real Time Clock) of PLC can be setup as follow steps.

[Steps]

1. Select [Online]-[Connect] to connect to PLC.
2. Select [Online]-[PLC Information].
3. Select the PLC RTC tap.

[Dialog Box]

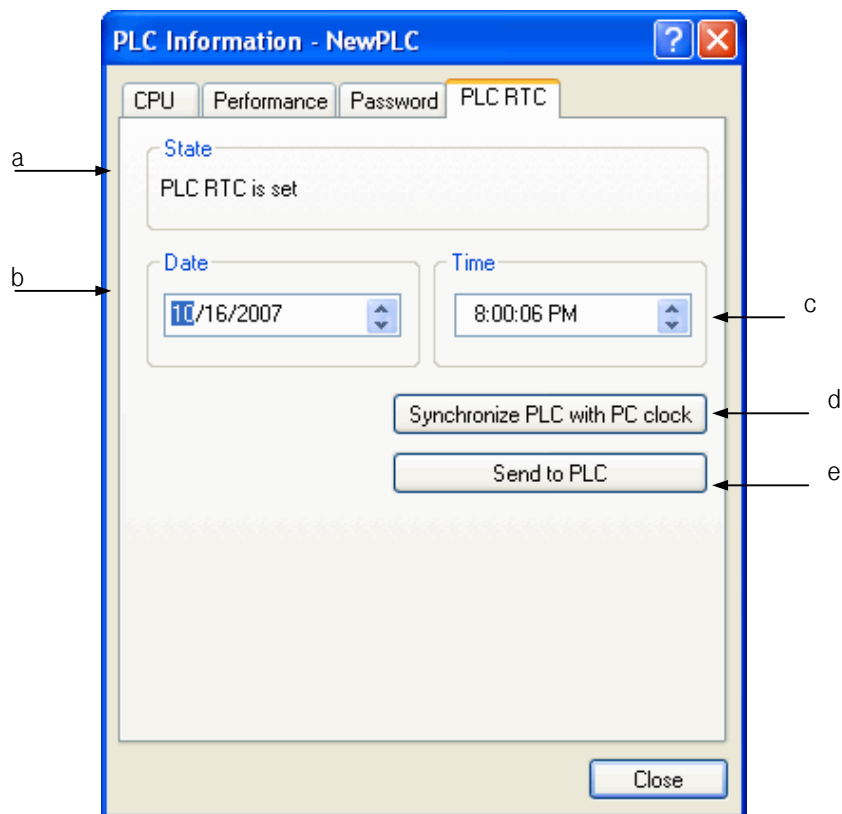

[Description of Dialog Box]

- a. State: shows PLC timer setting status. If the timer is not specified, PLC time will not be read.
- b. Date: displays date.
- c. Time: displays time.
- d. Synchronize PLC with PC clock: synchronizes date and time between PC and PLC.
- e. Send to PLC: transfers user specified time to PLC.

## 10.10 PLC History

It displays the history data of error/warning, Change Mode and Shut down Log saved in PLC.

### 10.10.1 Error Log

[Steps]

1. Select [Online]-[Connect] to connect to PLC.
2. Select [Online]-[PLC History].
3. Select the Error Log tap on PLC History Dialog Box.

[Dialog Box]

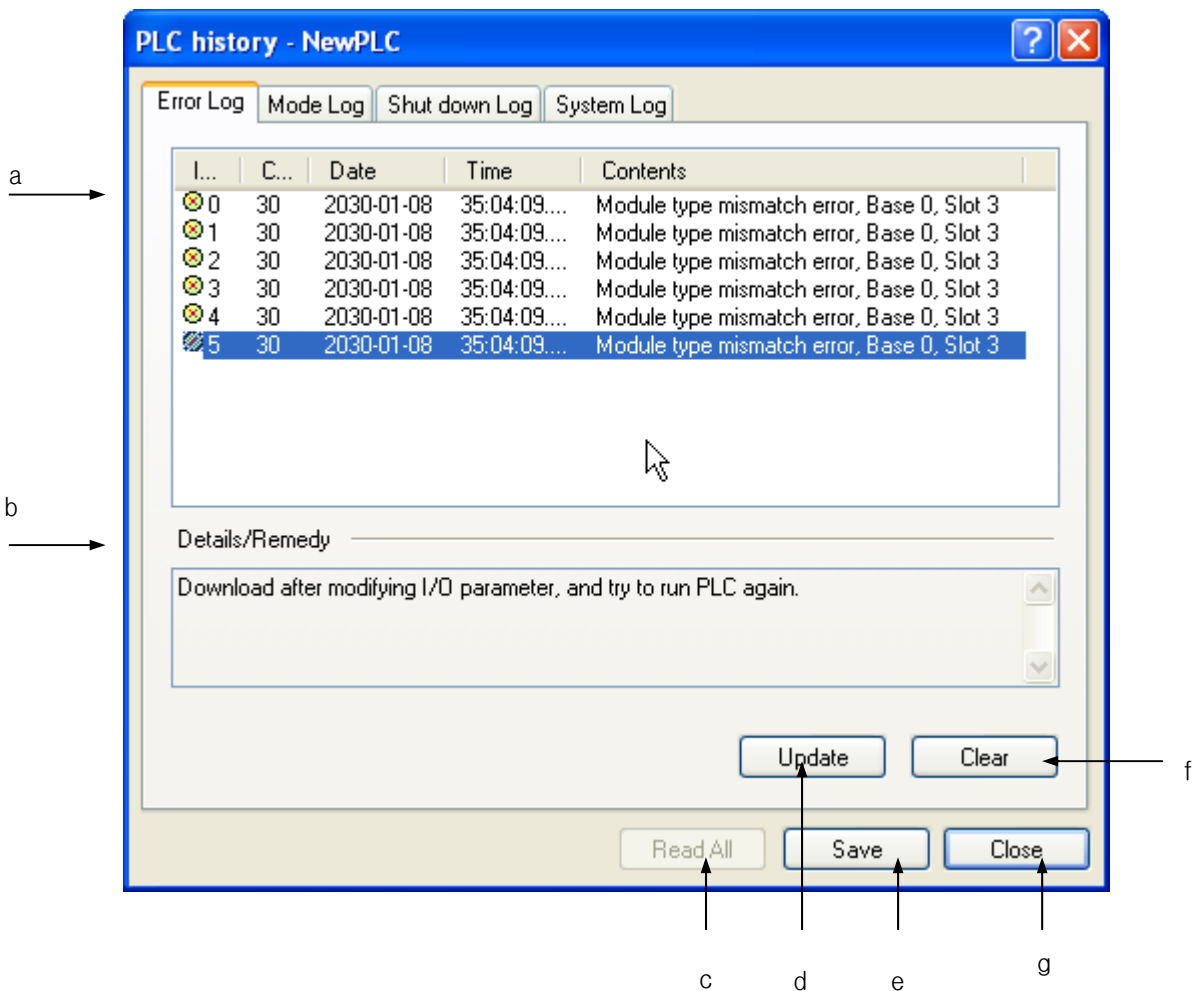

[Description of Dialog Box]

- a. List: displays Error Log.
- b. Details/Remedy: displays details of the error selected from the history along with action to take against the error.
- c. Read All: reads and displays all PLC histories.
- d. Update: reads PLC history again.
- e. Save: saves PLC history on file.
- f. Clear: deletes PLC history.
- g. Close: closes the Dialog Box.

### 10.10.2 Change Mode History

It shows the Mode Change Log of PLC operation modes.

[Dialog Box]

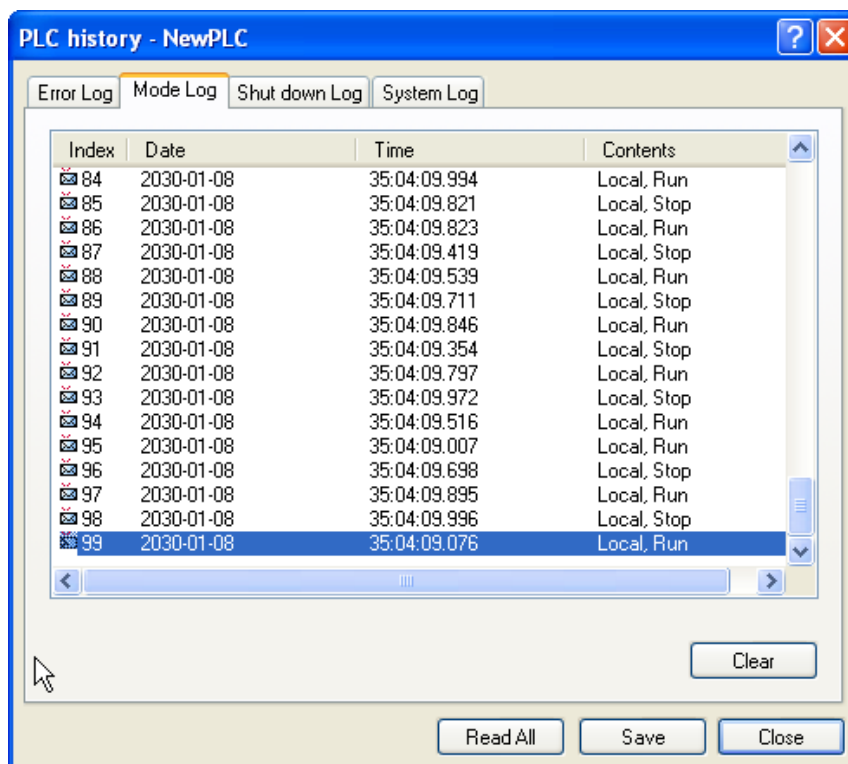

### 10.10.3 Shut down Log History

It shows the Shut down Log history of PLC.

[Dialog Box]

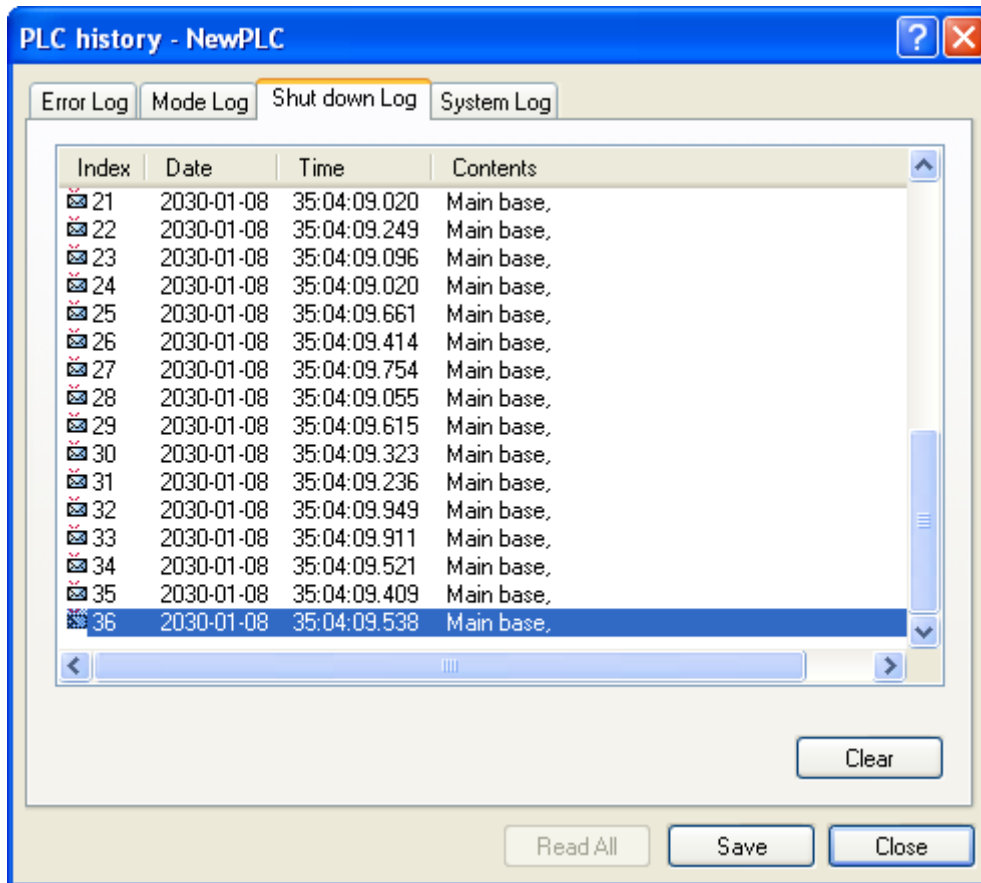

#### Notes

- Base number where the power is cut also will be displayed.

### 10.10.4 System Log

It shows the history of works executed by XG5000 when PLC runs.

[Dialog Box]

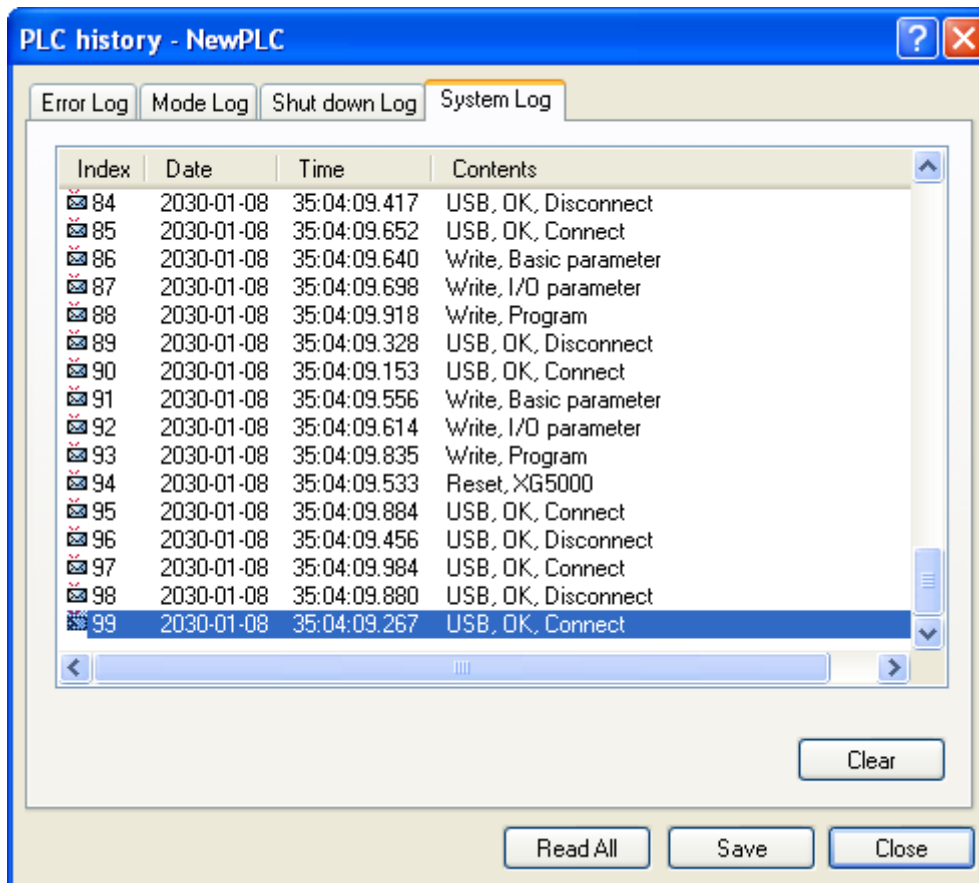

#### Notes

- Each history is arranged in time sequence.
- Each history will be saved on “.csv” file. This file can be open through Excel or other String editing programs.
- Double-click the first column of the list to change the arrangement method.
- On each Dialog Box displayed, 100 histories will be read respectively. Press Read All button to read more PLC histories.
- After pressing Read All or if the histories of PLC are less than 100, Read All button will be inactive.

## 10.11 PLC Error/Warning

Error/warning and previous Error Log presently saved in PLC can be checked.

[Steps]

1. Select [Online]-[Connect] to connect to PLC.
2. Select [Online]-[Error/Warning].

[Dialog Box]

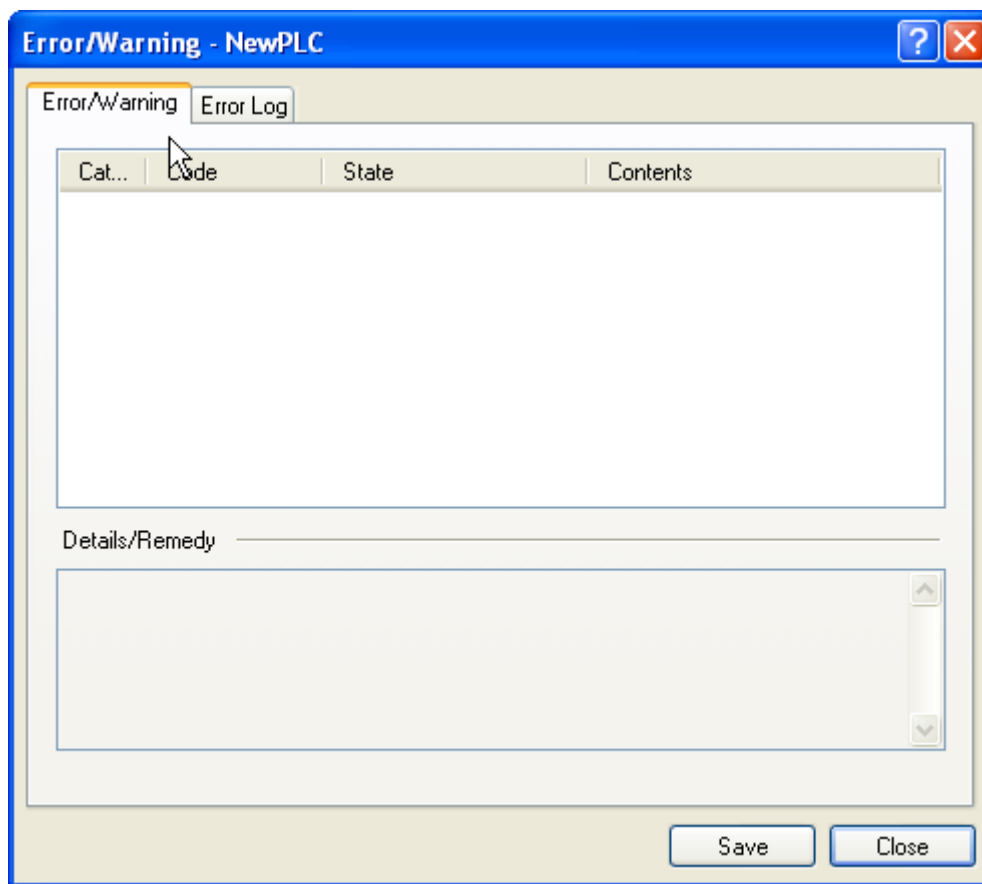



### Notes

- If any error or warning occurs during connection or Online, the Error/Warning dialog box will appear.
- If the error is "I/O parameter discordant, I/O installation error, fuse error, I/O Read/Write error, special communication module error", the applicable error's slot information will be displayed as well.
- In case of a program error (produced when PLC is converted from Stop to Run) or execution program error (produced when PLC is in Run), if PLC is same with program, double-click the area of program name to move to the applicable step if the program is identical to PLC program.

### 10.12 Flash Memory Setting

Flash memory operation of PLC can be specified.

Flash memory operation: When PLC operation mode Changes to Run, it executes Run operation after copying the program in the flash memory to the program memory. In other words, it runs PLC through the program in the flash memory.

(PLC operation in Run mode: it means that the operation mode changes from Stop to Run, and that the operation mode is Run when PLC is powered back on)

[Steps]

1. Select [Online]-[Connect] to connect to PLC.
2. Select [Online]-[Set Flash Memory].

[Dialog Box]

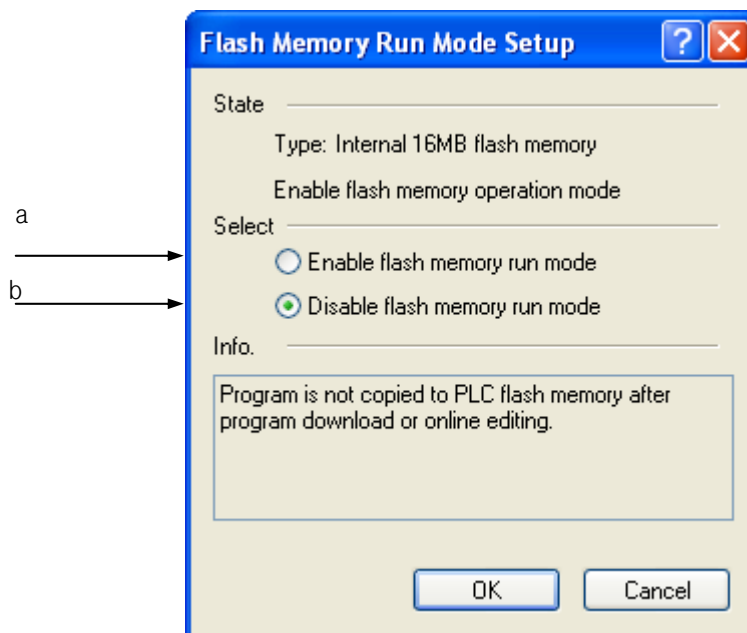

[Description of Dialog Box]

- a. Enable flash memory run mode: specifies the flash memory's operation mode.
- b. Disable flash memory run mode: cancels the flash memory's operation mode.

Notes

- If a flash memory operation mode is specified, the program can be copied to the flash memory after Program Write or Modification Write during Run.

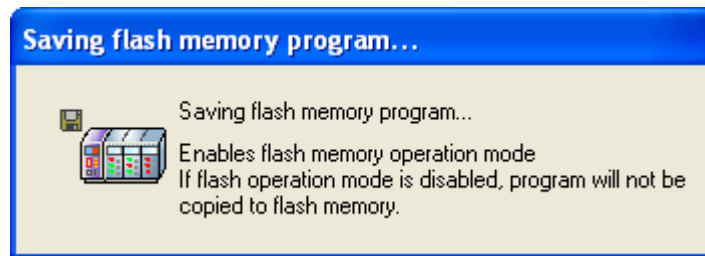

- The flash memory operation mode setting is prepared to recover the program when PLC status is not normal.

### 10.13 Forced I/O Setting

Forced I/O of the I/O refresh area can be specified in PLC.

[Steps]

1. Select [Online]-[Forced I/O Setting].

#### Notes

- To obtain Forced I/O information, it will take about 5 sec. at a speed of 115200bps with RS-232C connected, or about 1 sec. with USB.

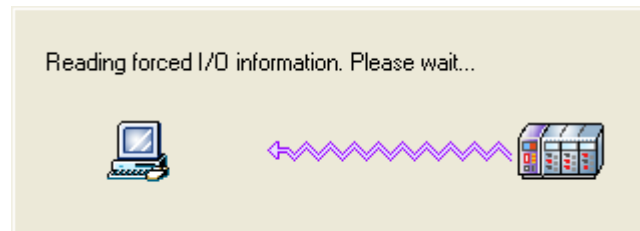

[Dialog Box]

**Forced I/O Setup**

Move address  
 Base: 0 Slot: 0

Forced input:  Enable  Disable  
 Forced output:  Enable  Disable

Apply

Force I/O

%Iw0.0.0		%Iw0.0.1		%Iw0.0.2		%Iw0.0.3	
Flag	Data	Flag	Data	Flag	Data	Flag	Data
0	0	16	16	32	32	48	48
1	1	17	17	33	33	49	49
2	2	18	18	34	34	50	50
3	3	19	19	35	35	51	51
4	4	20	20	36	36	52	52
5	5	21	21	37	37	53	53
6	6	22	22	38	38	54	54
7	7	23	23	39	39	55	55
8	8	24	24	40	40	56	56
9	9	25	25	41	41	57	57
10	10	26	26	42	42	58	58
11	11	27	27	43	43	59	59
12	12	28	28	44	44	60	60
13	13	29	29	45	45	61	61
14	14	30	30	46	46	62	62
15	15	31	31	47	47	63	63

Setting device list

Delete

Legend: ● Flag ■ Input ● Output

Buttons: Variables, Delete All, Select All, OK, Cancel

### [Description of Dialog Box]

- a. Move address: Moves to an address by using base, slot selection box.
- b. Forced Input: used to decide to allow Forced Input or not. Forced input value per bit will be applicable only when the Forced Input is allowed.
- c. Forced Output: used to decide to allow Forced Output or not. Forced output value per bit will be applicable only when the Forced Output is allowed.
- d. Apply: saves the changed items in PLC without closing the dialog box.
- e. Forced I/O: used to specify the flag and data for each bit.

### Notes

- The flag displays the Forced I/O application status for each bit. If the flag is selected, it means Enable, and if not, it means Disable.
- The data displays the forced value. If selected, 1 will be the forced value, and if not, 0 will be the forced value. However, it is effective only when the flag is in Enable status.

Flag	Data	Forced Value
0 (not selected)	0 (not selected)	X
0 (not selected)	1 (selected)	X
1 (selected)	0 (not selected)	0
1 (selected)	1 (selected)	1

- f. Setting device list: displays the device with the Forced I/O flag or data specified.
- g. Delete: deletes the flag and data specified in the selected device from the specified devices list.
- h. Variables: displays the list of variable/comment).
- i. Delete All: used to cancel the specified flag and data for all areas.
- j. Select All: used to specify the flag and data for all areas.
- k. OK: applies the changed items and closes the dialog box.
- l. Cancel: closes the dialog box.

### Notes

- If Variables Dialog button is pressed, the only Variable declared on I or Q device will be displayed.

Notes

- In case of an output module, if the output module installed on the actual PLC is 64-bit and less, the flag and data can be specified for the other bits than the output module points.

Ex) If 32-point output module is installed on the main base 1 slot the flag and data can be specified for the 32 points (%QW0.1.2, %QW0.1.3).

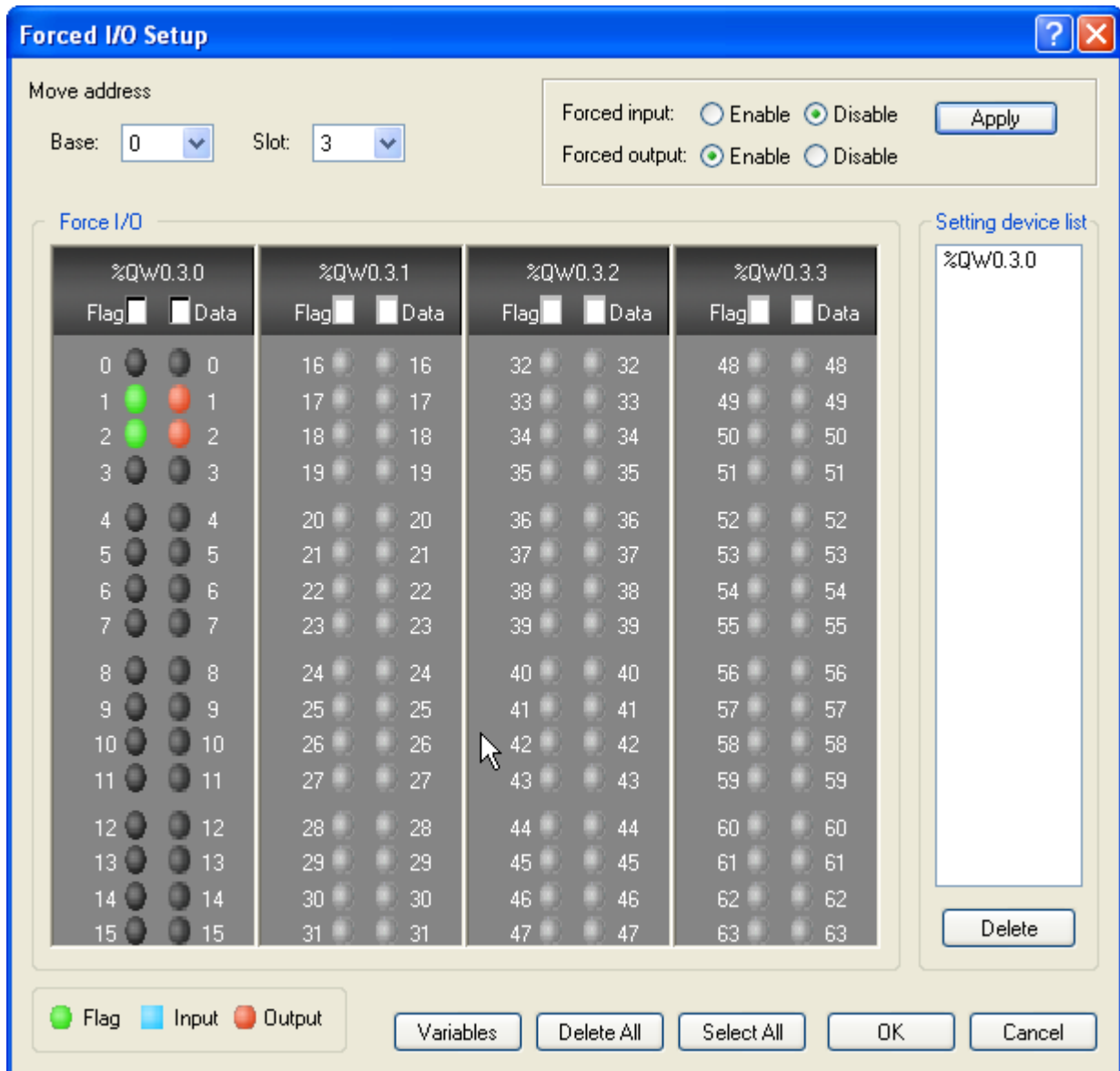

## 1) Forced I/O Setting

[Steps] (Example: the 4<sup>th</sup> bit of Base 0, Slot 0 forced output 1, 7<sup>th</sup> bit forced output 0)

1. Select base 0 and slot 0.

Move address

Base:  Slot:

%Iw0.0.0				%Iw0.0.1				%Iw0.0.2				%Iw0.0.3			
Flag		Data		Flag		Data		Flag		Data		Flag		Data	
0	<input type="checkbox"/>	<input type="checkbox"/>	0	16	<input type="checkbox"/>	<input type="checkbox"/>	16	32	<input type="checkbox"/>	<input type="checkbox"/>	32	48	<input type="checkbox"/>	<input type="checkbox"/>	48
1	<input type="checkbox"/>	<input type="checkbox"/>	1	17	<input type="checkbox"/>	<input type="checkbox"/>	17	33	<input type="checkbox"/>	<input type="checkbox"/>	33	49	<input type="checkbox"/>	<input type="checkbox"/>	49
2	<input type="checkbox"/>	<input type="checkbox"/>	2	18	<input type="checkbox"/>	<input type="checkbox"/>	18	34	<input type="checkbox"/>	<input type="checkbox"/>	34	50	<input type="checkbox"/>	<input type="checkbox"/>	50
3	<input type="checkbox"/>	<input type="checkbox"/>	3	19	<input type="checkbox"/>	<input type="checkbox"/>	19	35	<input type="checkbox"/>	<input type="checkbox"/>	35	51	<input type="checkbox"/>	<input type="checkbox"/>	51
4	<input type="checkbox"/>	<input type="checkbox"/>	4	20	<input type="checkbox"/>	<input type="checkbox"/>	20	36	<input type="checkbox"/>	<input type="checkbox"/>	36	52	<input type="checkbox"/>	<input type="checkbox"/>	52
5	<input type="checkbox"/>	<input type="checkbox"/>	5	21	<input type="checkbox"/>	<input type="checkbox"/>	21	37	<input type="checkbox"/>	<input type="checkbox"/>	37	53	<input type="checkbox"/>	<input type="checkbox"/>	53
6	<input type="checkbox"/>	<input type="checkbox"/>	6	22	<input type="checkbox"/>	<input type="checkbox"/>	22	38	<input type="checkbox"/>	<input type="checkbox"/>	38	54	<input type="checkbox"/>	<input type="checkbox"/>	54
7	<input type="checkbox"/>	<input type="checkbox"/>	7	23	<input type="checkbox"/>	<input type="checkbox"/>	23	39	<input type="checkbox"/>	<input type="checkbox"/>	39	55	<input type="checkbox"/>	<input type="checkbox"/>	55
8	<input type="checkbox"/>	<input type="checkbox"/>	8	24	<input type="checkbox"/>	<input type="checkbox"/>	24	40	<input type="checkbox"/>	<input type="checkbox"/>	40	56	<input type="checkbox"/>	<input type="checkbox"/>	56
9	<input type="checkbox"/>	<input type="checkbox"/>	9	25	<input type="checkbox"/>	<input type="checkbox"/>	25	41	<input type="checkbox"/>	<input type="checkbox"/>	41	57	<input type="checkbox"/>	<input type="checkbox"/>	57
10	<input type="checkbox"/>	<input type="checkbox"/>	10	26	<input type="checkbox"/>	<input type="checkbox"/>	26	42	<input type="checkbox"/>	<input type="checkbox"/>	42	58	<input type="checkbox"/>	<input type="checkbox"/>	58
11	<input type="checkbox"/>	<input type="checkbox"/>	11	27	<input type="checkbox"/>	<input type="checkbox"/>	27	43	<input type="checkbox"/>	<input type="checkbox"/>	43	59	<input type="checkbox"/>	<input type="checkbox"/>	59
12	<input type="checkbox"/>	<input type="checkbox"/>	12	28	<input type="checkbox"/>	<input type="checkbox"/>	28	44	<input type="checkbox"/>	<input type="checkbox"/>	44	60	<input type="checkbox"/>	<input type="checkbox"/>	60
13	<input type="checkbox"/>	<input type="checkbox"/>	13	29	<input type="checkbox"/>	<input type="checkbox"/>	29	45	<input type="checkbox"/>	<input type="checkbox"/>	45	61	<input type="checkbox"/>	<input type="checkbox"/>	61
14	<input type="checkbox"/>	<input type="checkbox"/>	14	30	<input type="checkbox"/>	<input type="checkbox"/>	30	46	<input type="checkbox"/>	<input type="checkbox"/>	46	62	<input type="checkbox"/>	<input type="checkbox"/>	62
15	<input type="checkbox"/>	<input type="checkbox"/>	15	31	<input type="checkbox"/>	<input type="checkbox"/>	31	47	<input type="checkbox"/>	<input type="checkbox"/>	47	63	<input type="checkbox"/>	<input type="checkbox"/>	63



2. Select the flag and data of the bit 3. %QW0.0.0 is registered to the established device.

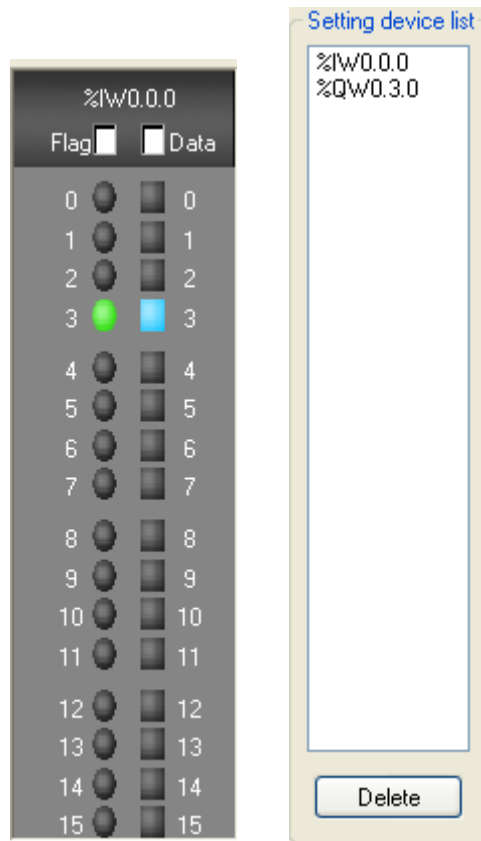

3. Select the flag of the bit 7. As the forced output value of the bit 7 is 0, no data needs to be selected. Since %QW0.0.0 is already registered to the pre-set device, it is not added again.

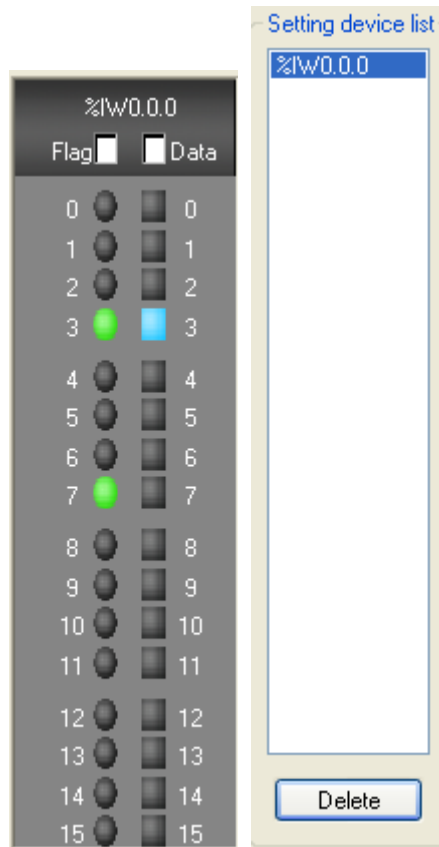

4. Select the Forced Output Enable Flag and then click Apply button to apply the forced value.

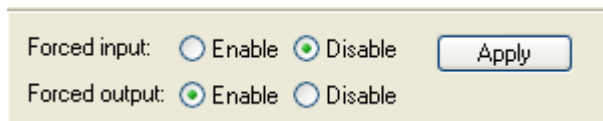

## 2) Forced I/O Cancel

[Steps] (Example: the 4<sup>th</sup> and 7<sup>th</sup> bit of Base0, Slot 0 forced value to cancel)

1. Move to %QW0.0.0. Use the button or directly input the area desired to move to.

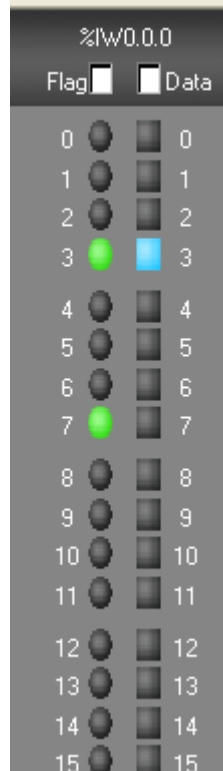

2. Cancel the bit 3 and 7's flag selected to cancel the forced output value

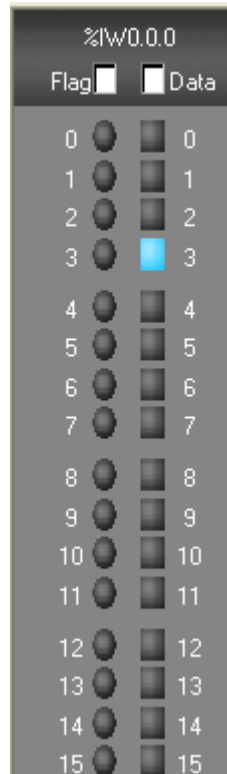

3. Click Apply button.

### Notes

Monitoring is to display the value of the calculation result of the program.

- In the case of the forced input, monitoring will be with the forced value since the forced input value is updated in the monitor area.

In the case of the forced output, monitoring will not be available since the forced value will be actually output regardless of the calculation result.

## 10.14 Skip I/O

It is used to decide to check or refresh the specific module during PLC operation.

[Steps]

1. Select [Online] - [Skip I/O].

[Dialog Box]

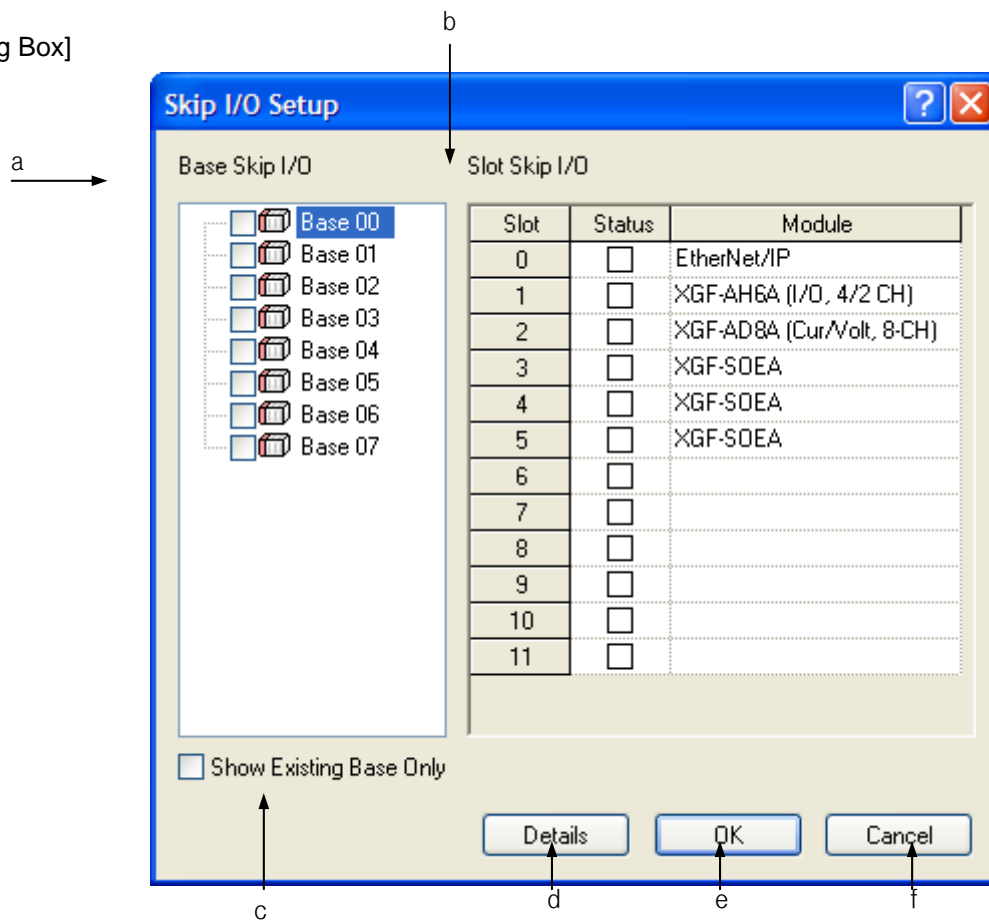

[Description of Dialog Box]

- a. Base Skip I/O: used to decide to skip the base I/O or not. If the base module is skipped, all slots in the base will be I/O skipped.
- b. Slot Skip I/O: used to decide to skip the slot I/O or not.
- c. Show Existing Base Only: shows existing base only
- d. Details: displays detailed information of the special module or the communication module only.
- e. OK: applies the changed items and closes the dialog box.
- f. Cancel: closes the dialog box.

1) Skip I/O Setting for each slot

[Steps]

1. Select the base with the slot to specify Skip I/O.

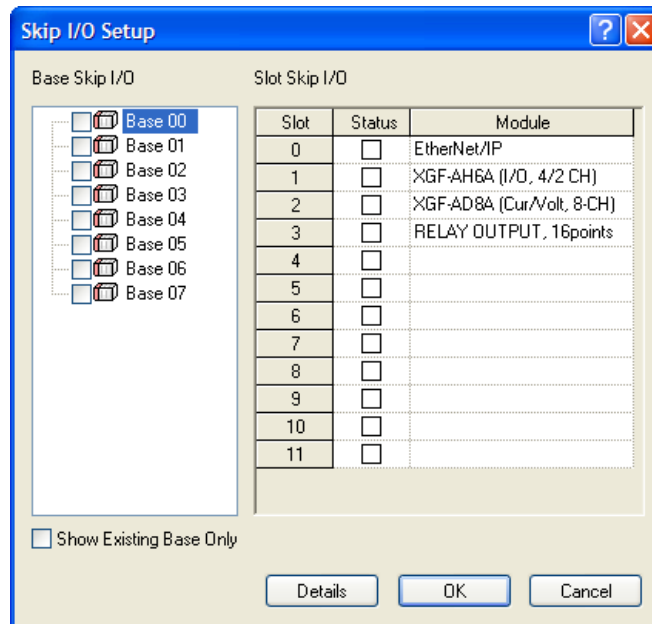

2. Select the slot to specify the Skip I/O.

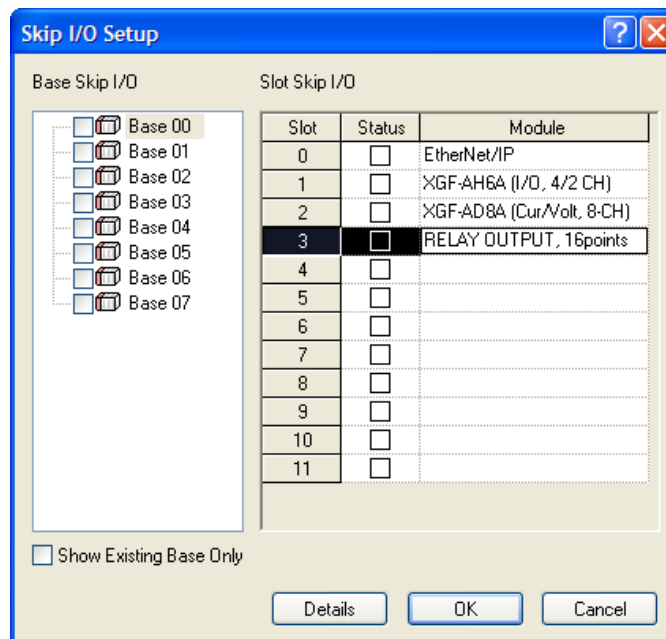

3. Select the check box of the status column. At this moment "\*"mark will be added to the base.

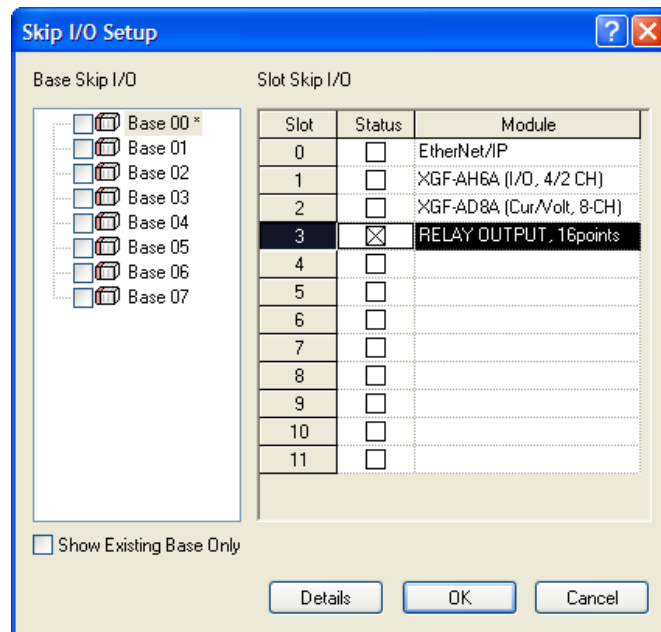

4. If you press OK, the changed items are displayed.

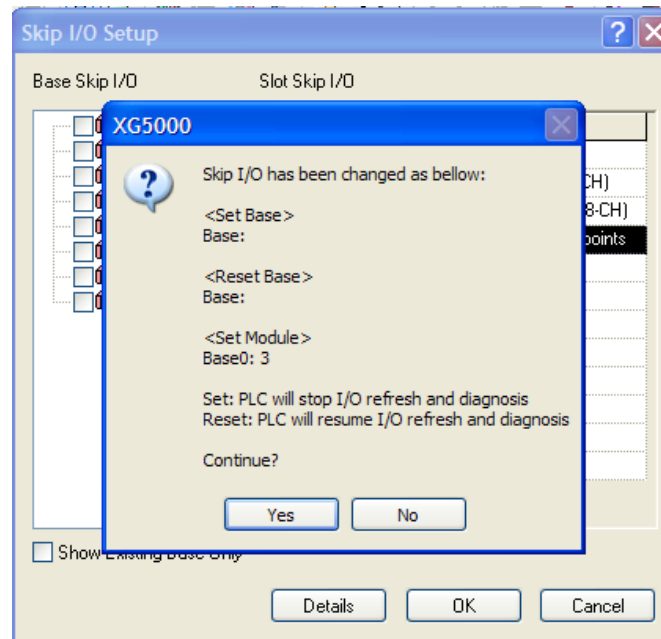

## 2) Skip I/O Cancel for each slot

[Steps]

1. Select the base to cancel the Skip I/O.
2. Select the slot to cancel the Skip I/O.
3. Cancel the selected check box of the status column. '\*'mark will be deleted if there is no slot any more where Skip I/O is specified in the applicable base.

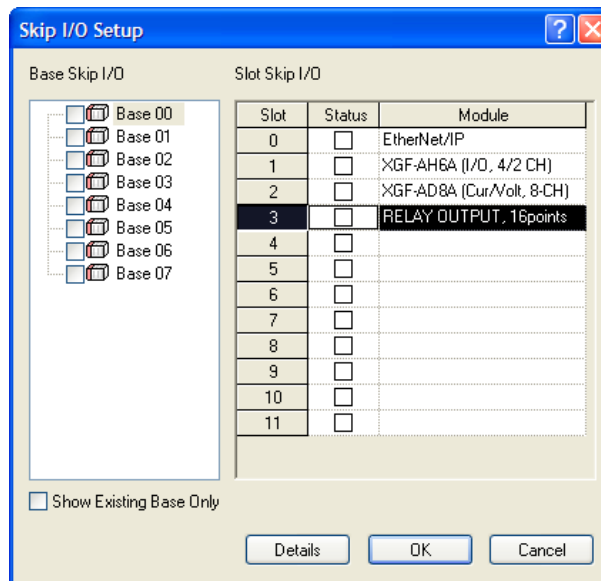

4. If you press OK, the changed items are displayed.

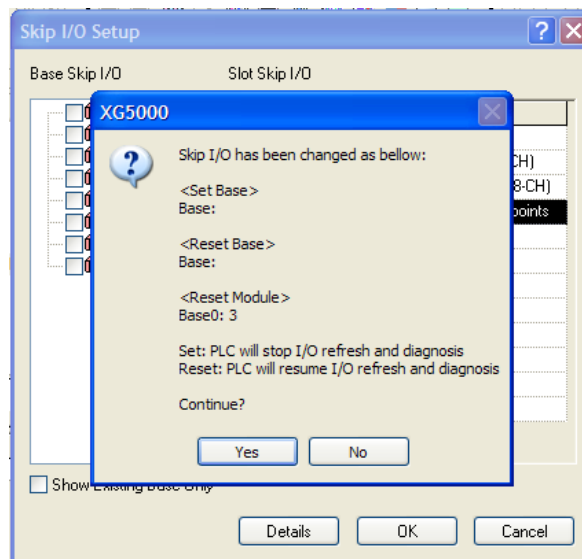



### 3) Base Skip I/O Setting

[Steps]

1. Select the base to specify the base Skip I/O.

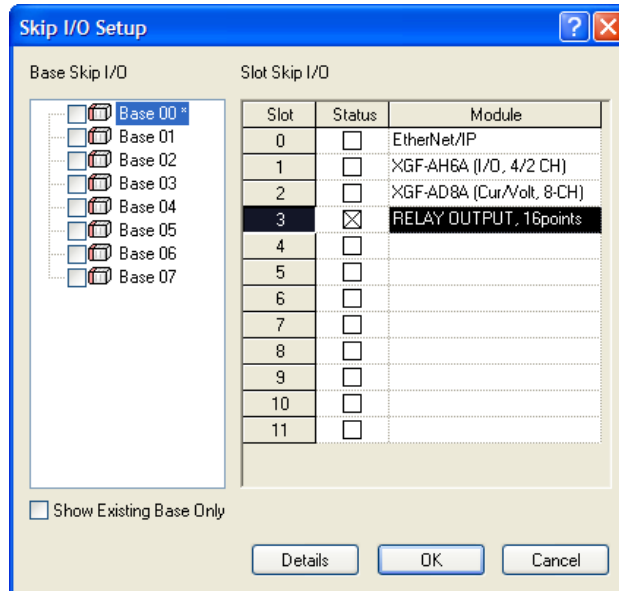

2. Select the check box.

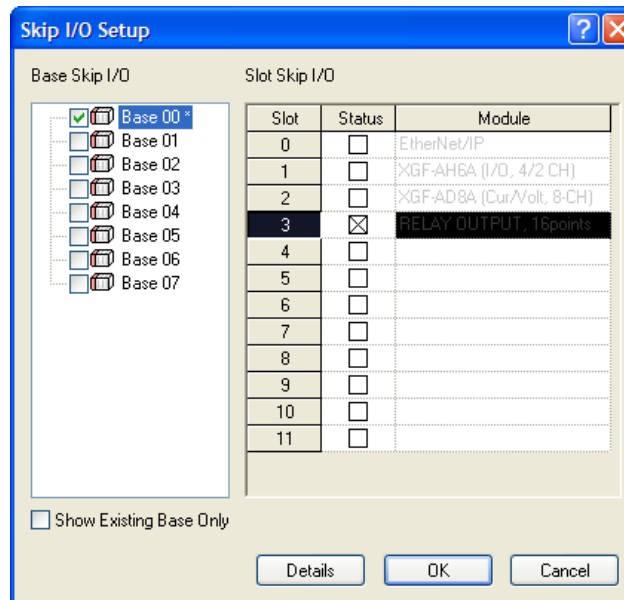

3.If you press OK, the changed items are displayed.

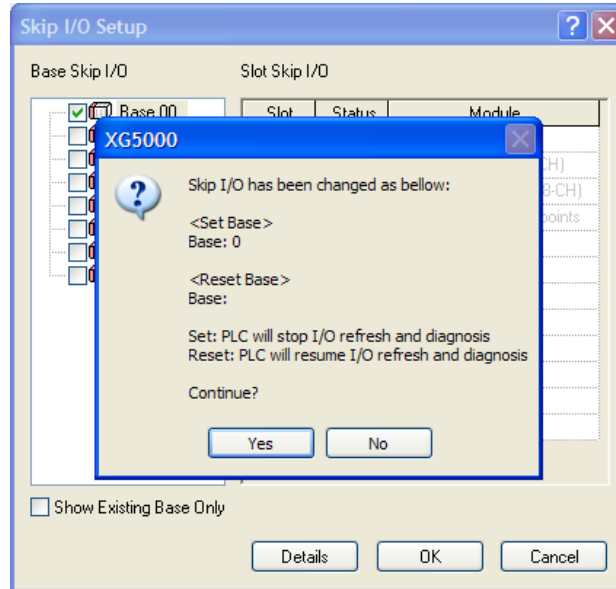

4) Base Skip I/O cancel

[Steps]

1. Select the base to cancel the base Skip I/O.

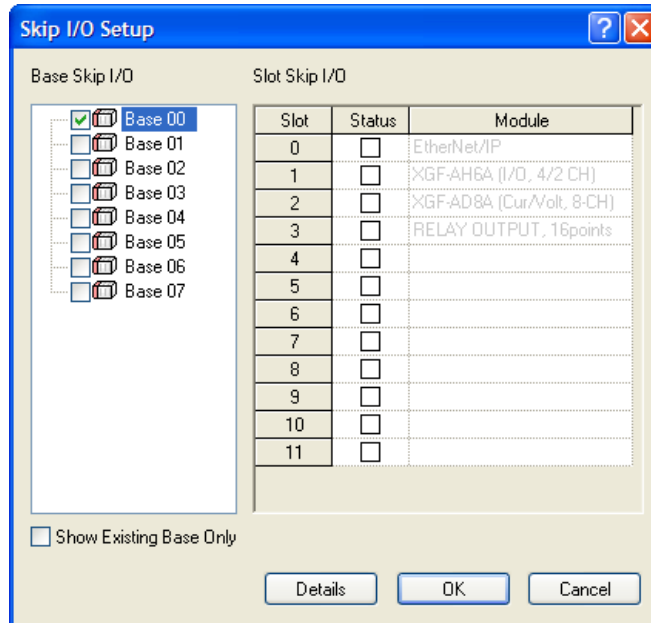

2. Cancel the check box selected. As the base Skip I/O is canceled, the Skip I/O for each slot can be specified or canceled

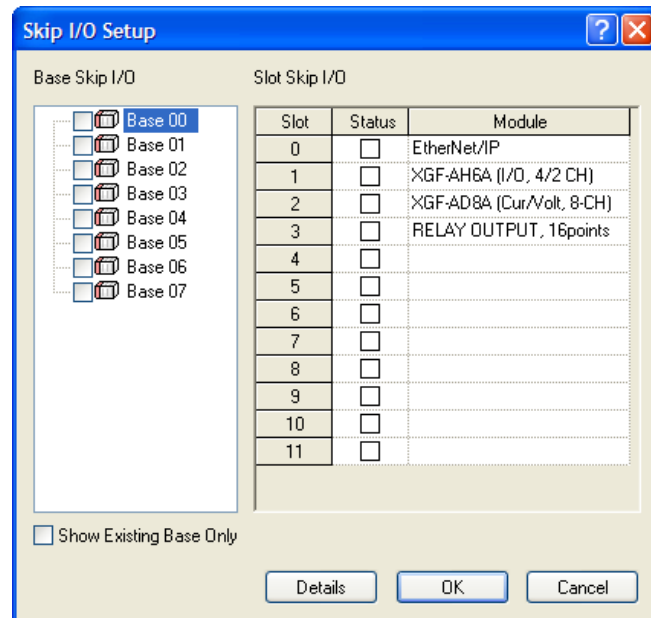

3.If you press OK, the changed items are displayed.

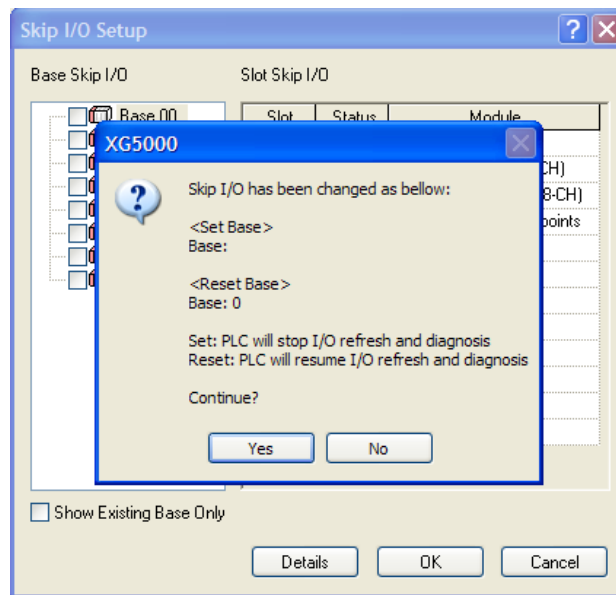

### Notes

- Click [OK] button to apply the specified Skip I/O.

## 10.15 Fault Mask

It is used to decide to keep running the module in Fault or not during PLC operation.

[Steps]

1. Select [Online]-[Fault Mask Setting].

[Dialog Box]

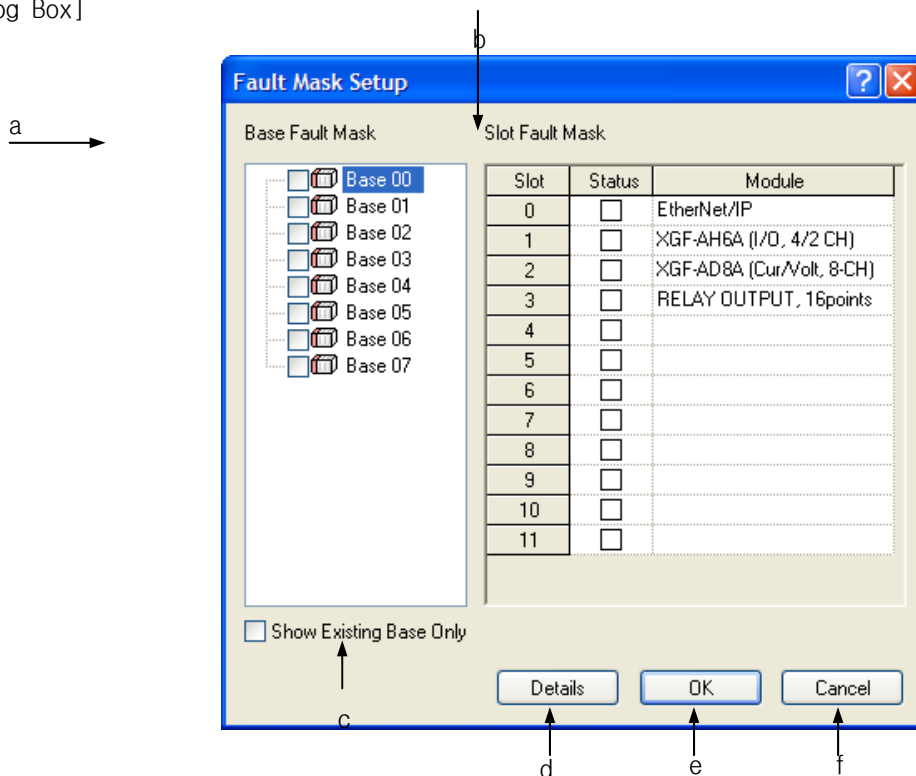

[Description of Dialog Box]

- a. Base Fault Mask: used to decide to apply base module's fault mask or not. If the base module's mask is specified, all slots in the base will be of the fault mask.
- b. Slot Fault Mask: used to decide to apply the fault mask for each slot or not.
- c. Show Existing Base Only: shows existing base only
- d. Details: displays detailed information of the special module or the communication module only.
- e. OK: applies the changed items and closes the dialog box.
- f. Cancel: closes the dialog box.

### Notes

- Canceling the 'Fault Mask' specified is identical as described in Skip I/O setting. Refer to Skip I/O Setting for its details .

### Notes

- The I/O Information dialog box which is similar to Fault Mask or I/O skip dialog box when [Online]-[I/O Information] is selected. I/O Sync. Button will be activated when PLC is STOP Mode.

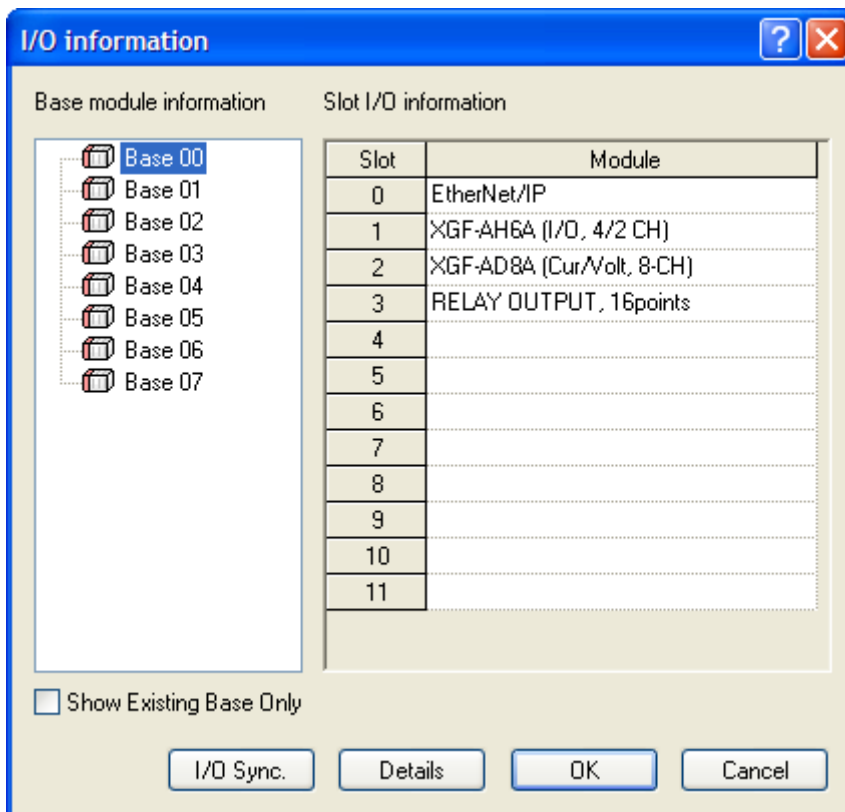

- The I/O Parameter of XG5000 project will be synchronized with the real module installation information when I/O Sync. button is clicked. Please be careful since the previous I/O parameter will be erased.

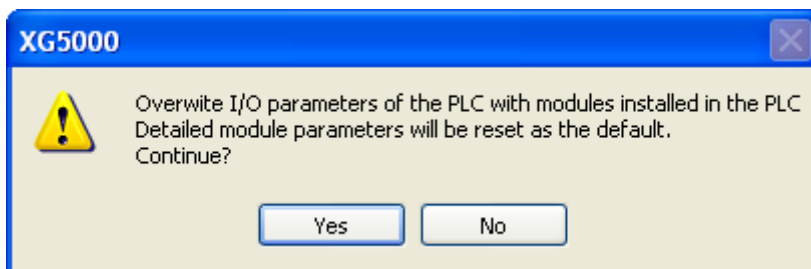

## 10.16 Module Changing Wizard

This Wizard is used to change the module during PLC operation.

### Note

- Module Changing Wizard can be executed only in Run mode
- In case there is PLC error, you can't start Module Changing Wizard.

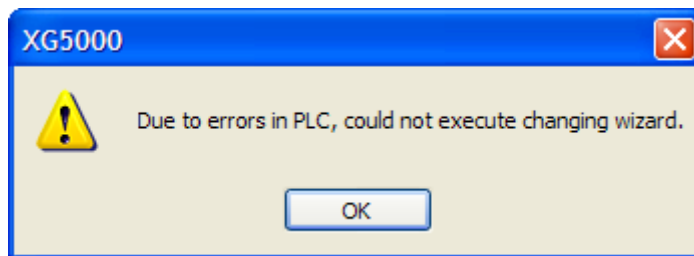

### [Steps]

1. Select [Online]-[Module Changing Wizard].
2. Select the module to change at the module selection stage and then click Next button.

### [Dialog Box]

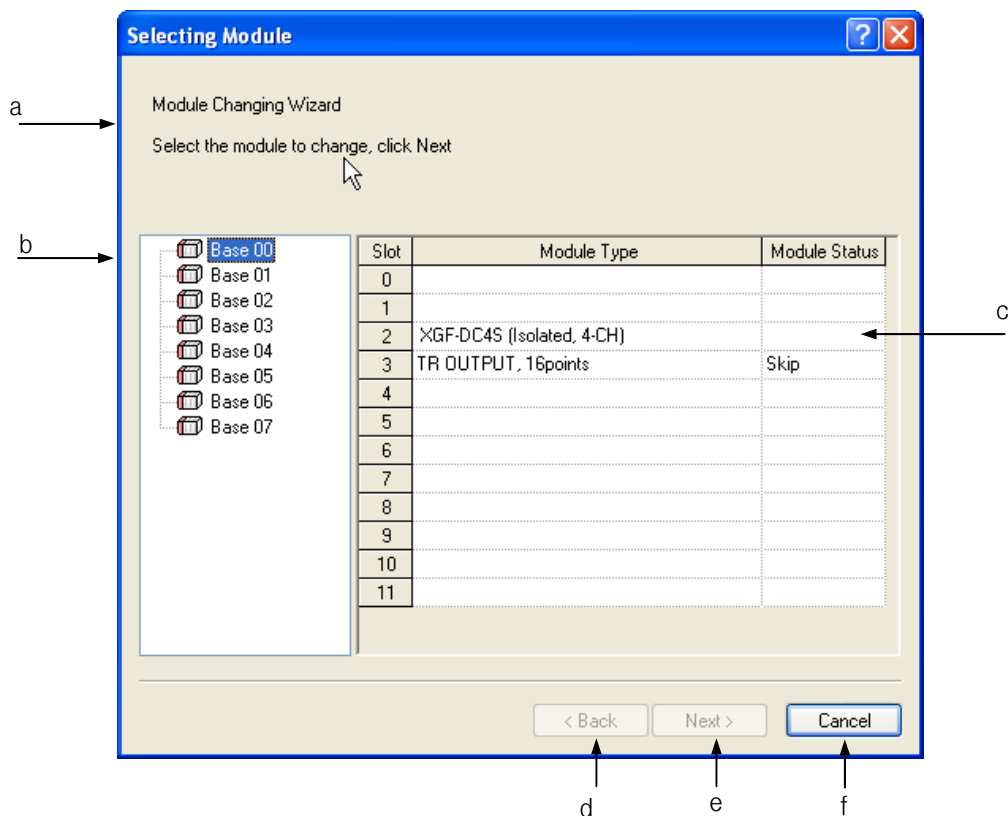

[Description of Dialog Box]

- a. Comment: displays the comment of the module selection stage.
- b. Base Module Tree: displays the base module.
- c. Slot Modules List: displays the information of the slot installed on the base module.
- d. Back: It will be inactive at the module selection stage.
- e. Next: used to move to the module confirming stage. It will be active only if the module to change is selected.
- f. Cancel: Finishes the Module Changing Wizard.

3. Check the module to change at the module confirming stage.

[Dialog Box]

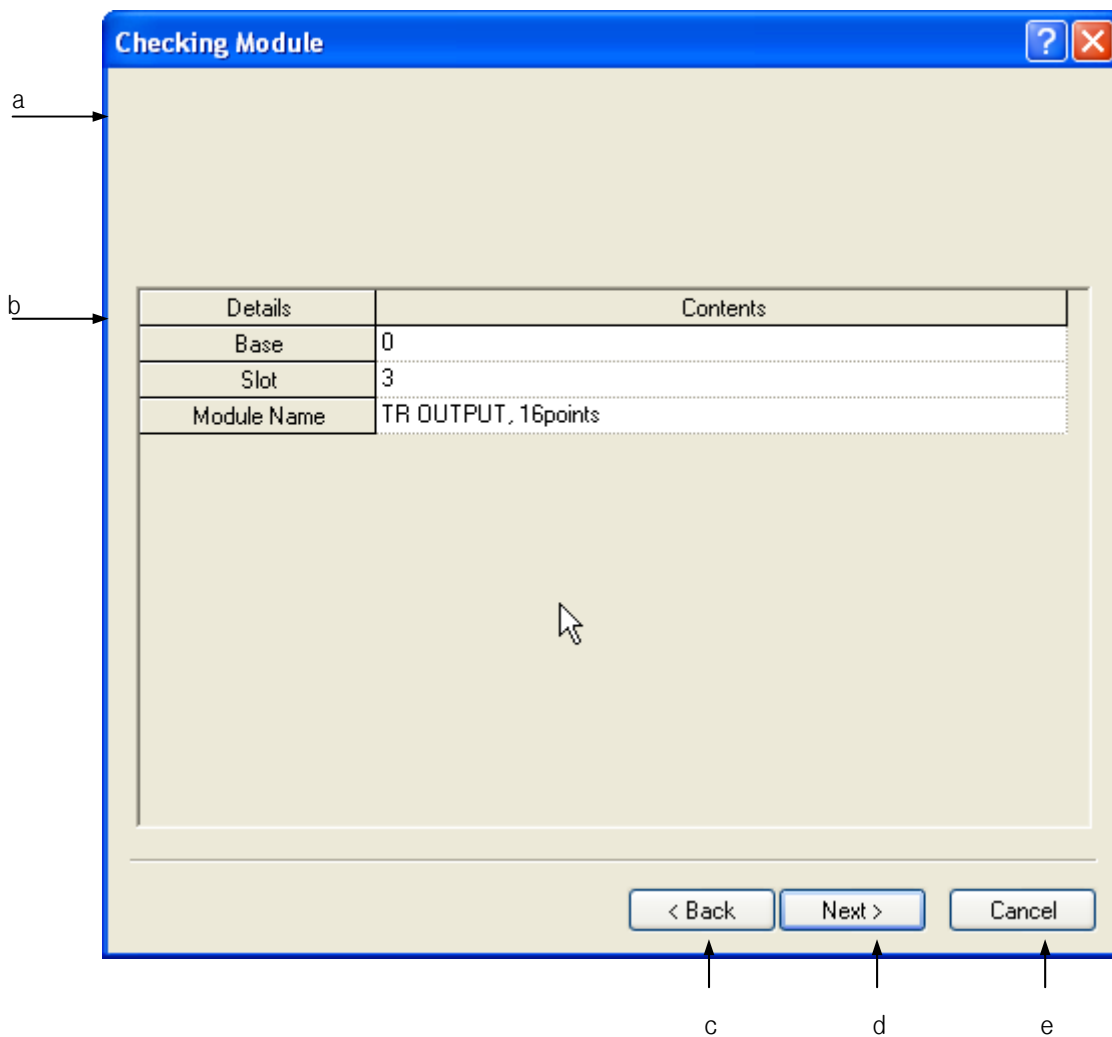



## [Description of Dialog Box]

- a. Comment: displays the comment of the module confirming stage.
- b. Module Information: displays detailed information on the selected module.
- c. Back: used to move to the module selection stage.
- d. Next: used to move to the Removing Module.
- e. Cancel: closes the 'Module Changing Wizard'.

4. Click Next button if the information displayed is identical to the module to change, or click Back button to go back to the previous stage. In order to cancel the Module Changing Wizard, click Cancel button.
5. Remove the module at the Removing Module.

## [Dialog Box]

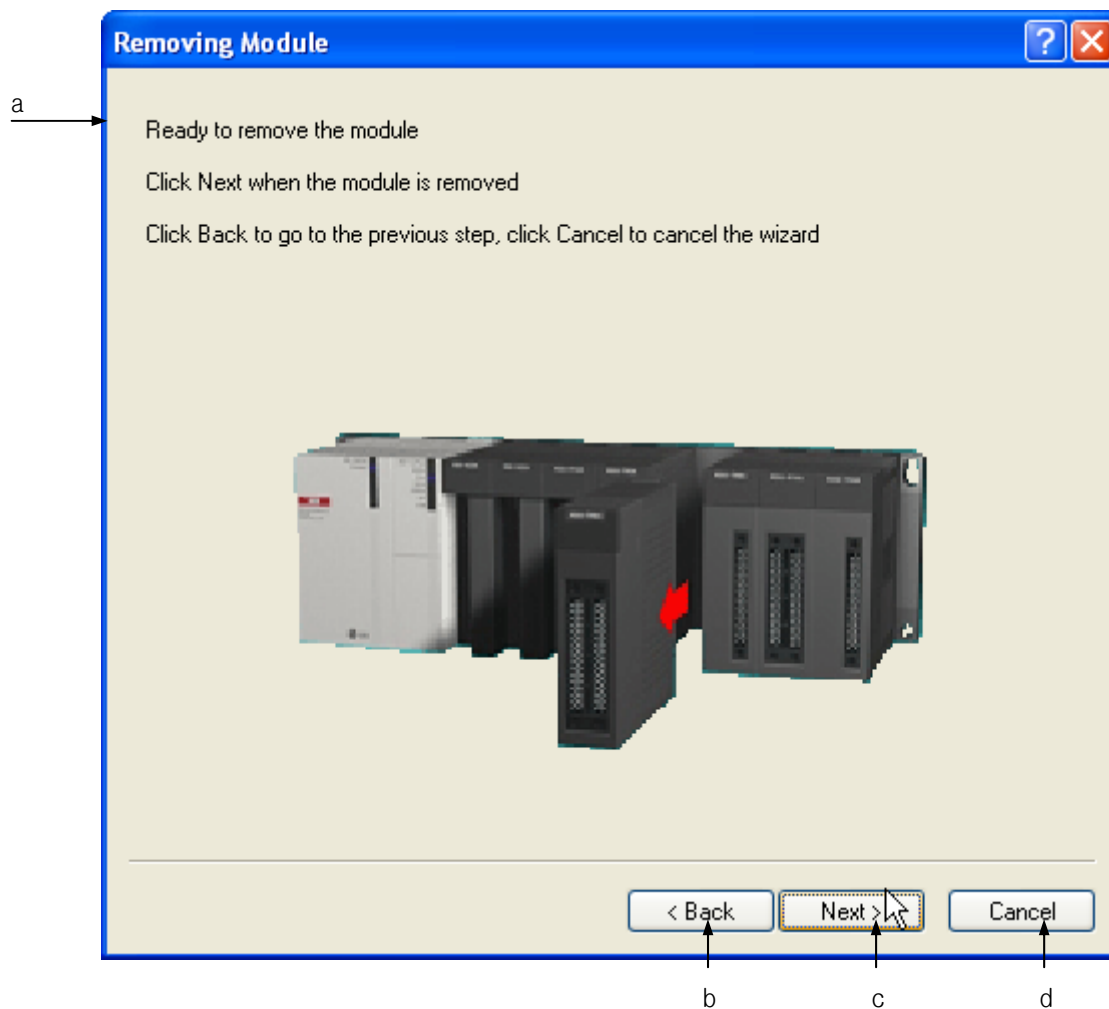

[Description of Dialog Box]

- a. Comment: displays the comment of the Removing Module.
  - b. Back: used to move to the confirming stage of the module removal.
  - c. Next: used to move to the module installation stage.
  - d. Cancel: closes the Module Changing Wizard.
6. If the module removed, click Next button. Or click Back button to move back to the previous stage.  
Or click Cancel to cancel the Module Changing Wizard.

### Notes

- If the module is not removed normally, an error message will appear on the comment.

7. Install the module at the module installation stage.

[Dialog Box]

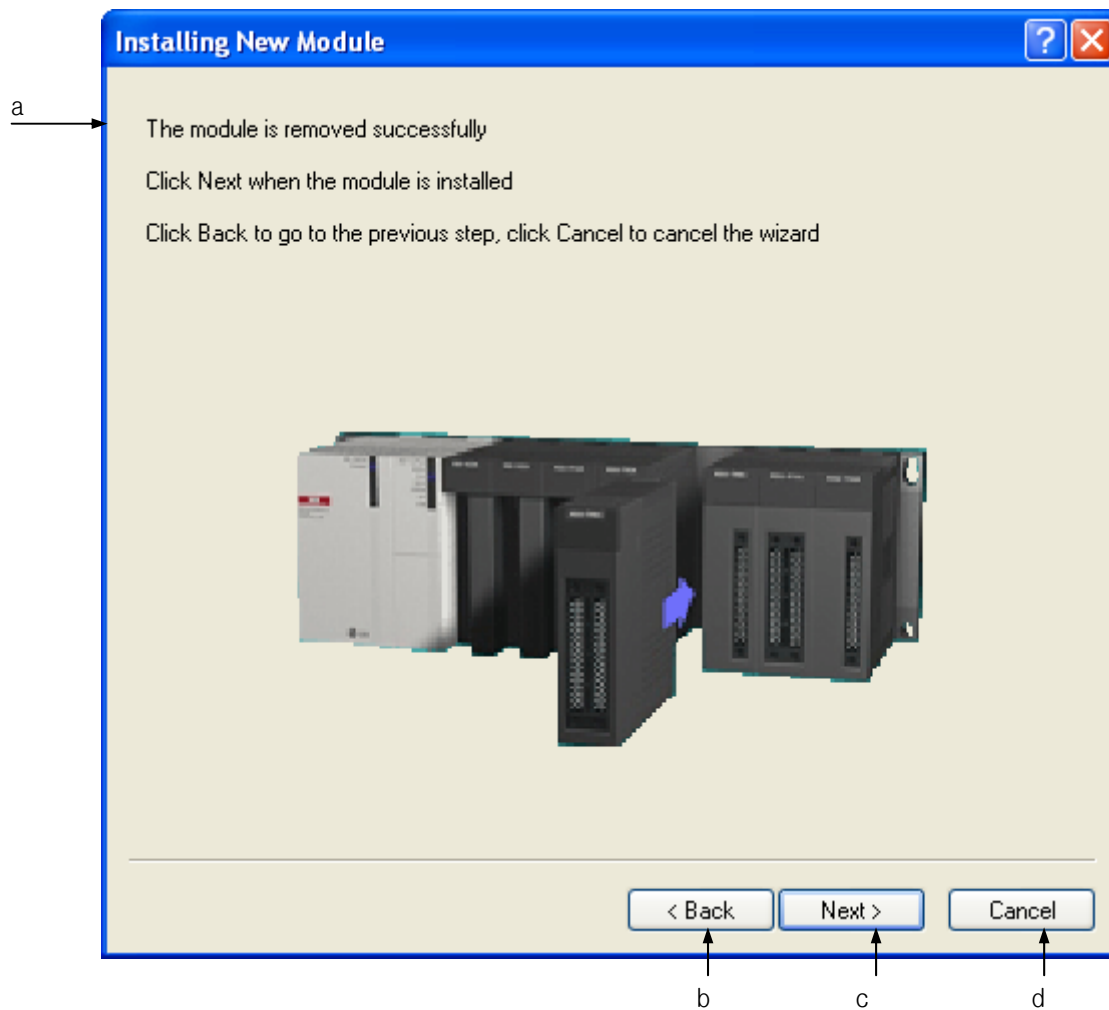

[Description of Dialog Box]

- a. Comment: displays the comment of the module installation stage.
- b. Back: used to move to the Removing Module.
- c. Next: used to move to the confirming stage of the module installation.
- d. Cancel: closes the Module Changing Wizard.

8. If the module installed, click Next button. Or click Back button to move back to the previous stage. Or click Cancel to cancel the Module Changing Wizard.

#### Notes

- If the module is not installed normally, an error message will appear on the comment.

9. Close the Module Changing Wizard.

[Dialog Box]

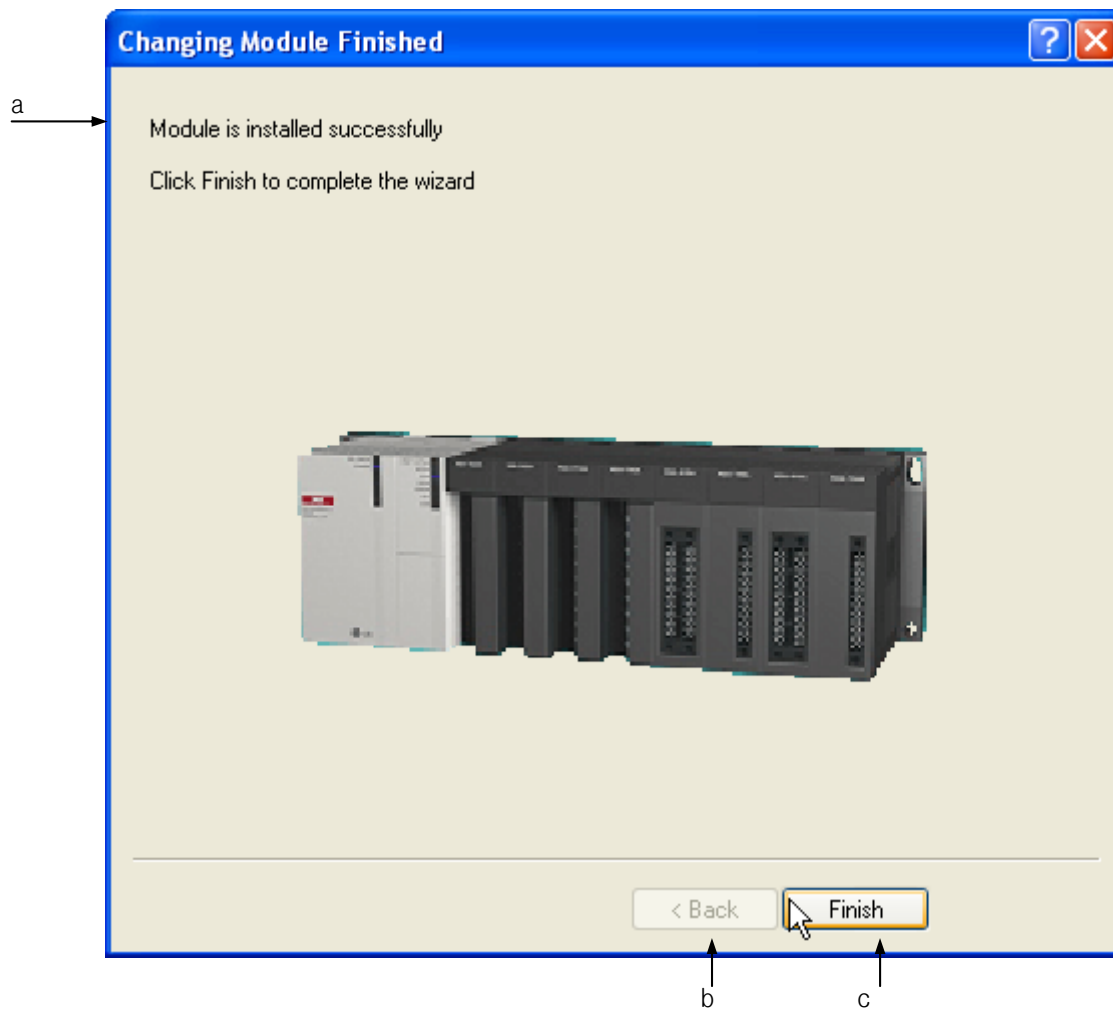

[Description of Dialog Box]

- a. Description: displays the comment of the module change complete stage.
- b. Back: It will be inactive since going back to previous stage is unavailable after the module changed.
- c. Finish: finishes the Module Changing Wizard.

### Notes

- If the Module Changing Wizard is cancelled, Fault Mask and Skip I/O may be set to protect the applicable module.

### Notes

- If you want to change the module without the Wizard, follow the sequence described below.

#### [Steps]

1. Set the Skip I/O for the module to change.
  2. Set the Fault Mask for the module to change.
  3. Remove the module from PLC.
  4. Install a new module.
  5. Release the Skip I/O for the applicable module.
  6. Select [Online]-[PLC Errors/Warnings] to check for any error on the applicable module.
  7. If no error found on the applicable module, release the Fault Mask for the module.
- Refer to Skip I/O and Fault Mask for more details on Skip I/O and Fault Mask specified for the module.

## 10.17 Custom Events

The Custom Events mean a series of events whose conditions are the devices specified by the user. User defined events are registered in PLC, which will monitor the registered events and record the event history if generated. The event history can be used to operate and debug the system.

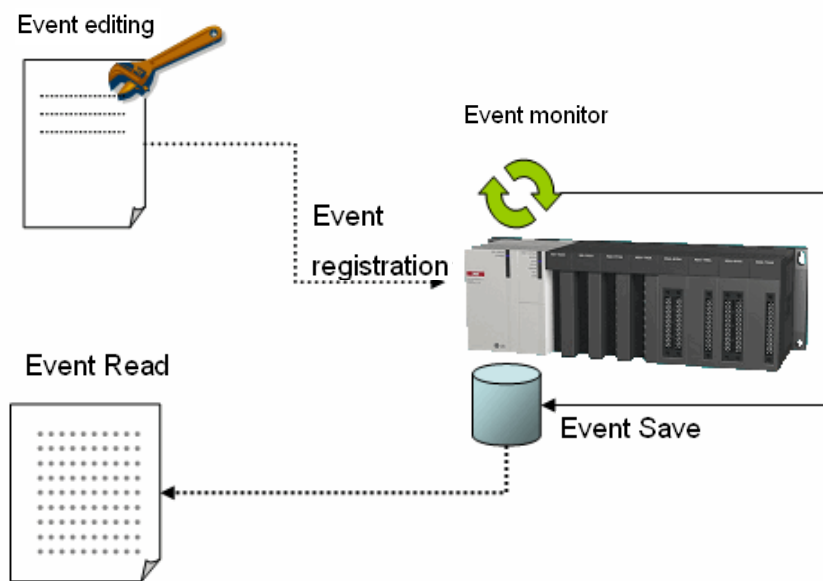

### 10.17.1 Example

The event is defined as the data of %MW0 whose data is increase by 1 every scan is greater than 100 and less than 110, and if the event is met, PLC stores the data of %MW0.

[Steps]

1. Make a program as follow.

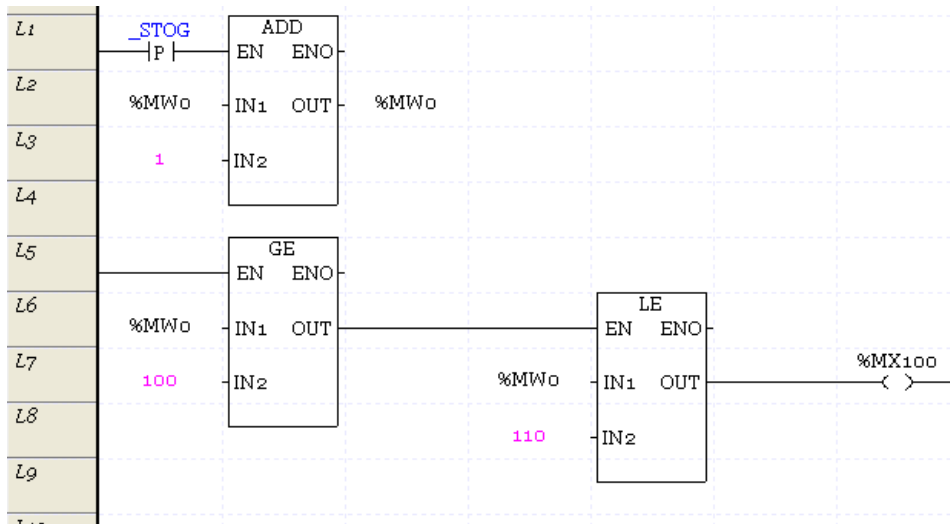

2. Write the program to the PLC and select [Monitor]-[Custom Event] on the Online menu.

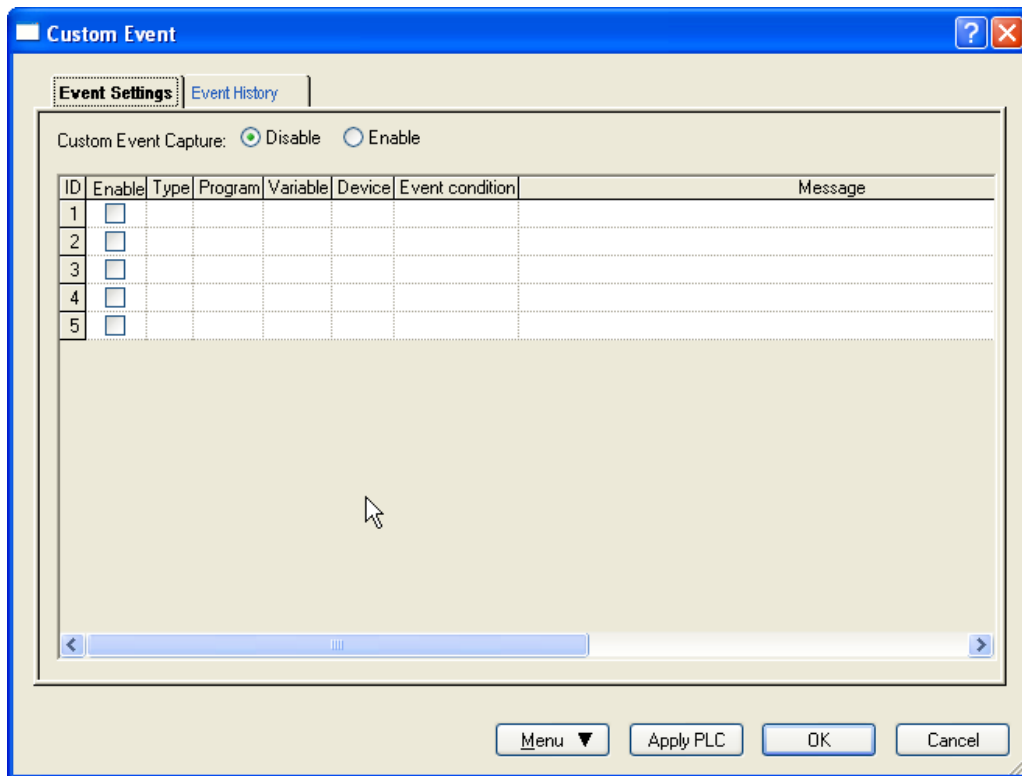

- Open Event Setup dialog box by clicking [Add event] and setup each items as figure below. In Event setting window, input %M100 in Device area and Select Transition on Event condition and Information in Type.

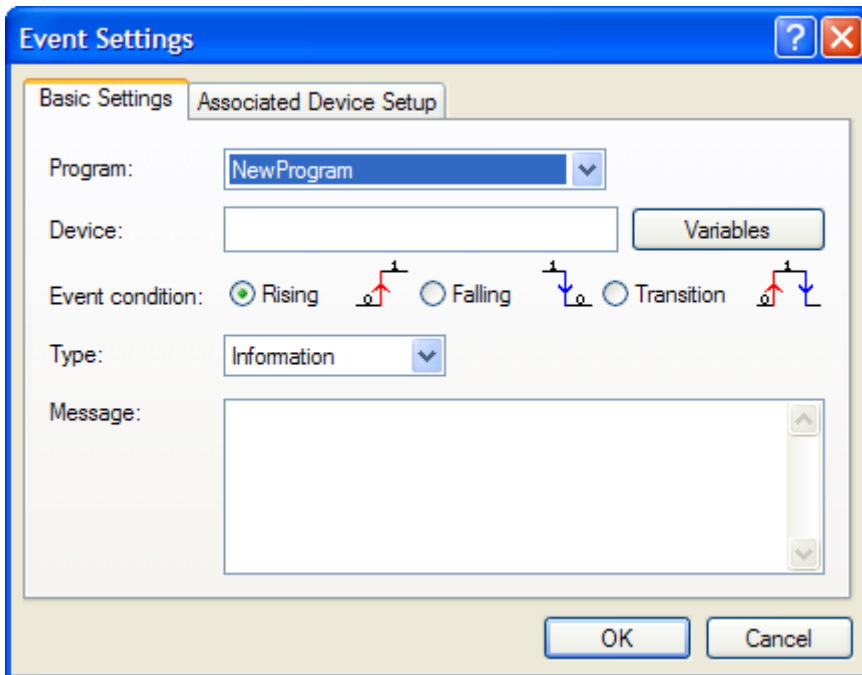

- Open 'Associated Device Setup' dialog box and setup the bit device %MX100 and word device %MW0 as figure below to store the data when event is met.

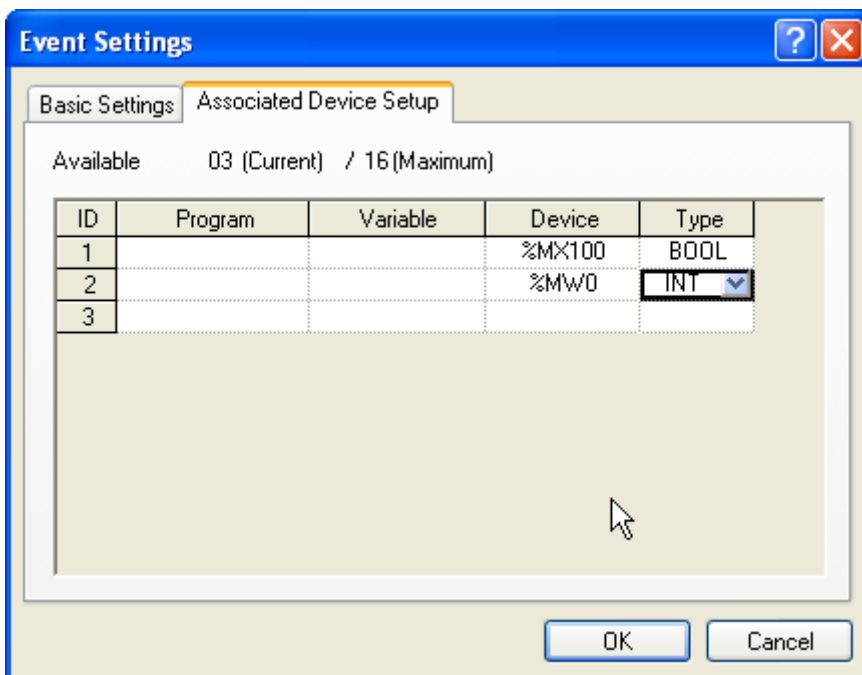



- Close the dialog box, select 'Enable' for 'Event allowance' on the upper side of dialog box and click 'OK' button. A message box will be displayed as figured below since the event setup has been changed. Click 'Yes' button on the message box.

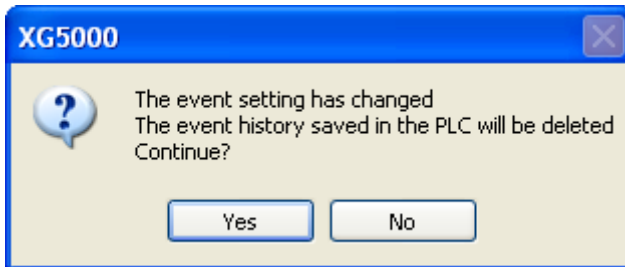

- Change the PLC mode RUN.
- Select [Monitor]-[Custom Event] on the Online menu to check event history and select event history tab on the 'Custom Event' dialog box.

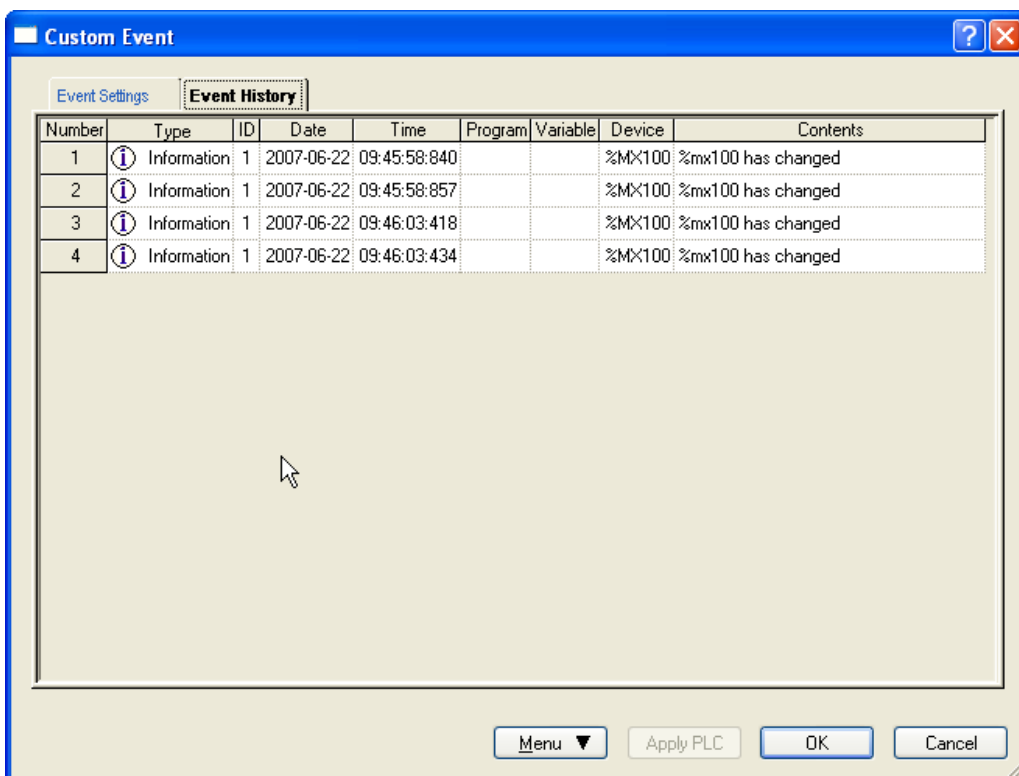

- An 'Event History' dialog box will be displayed when an event item is selected, and [Properties] button on the menu is clicked, where the list of associated device and the details of event can be seen.

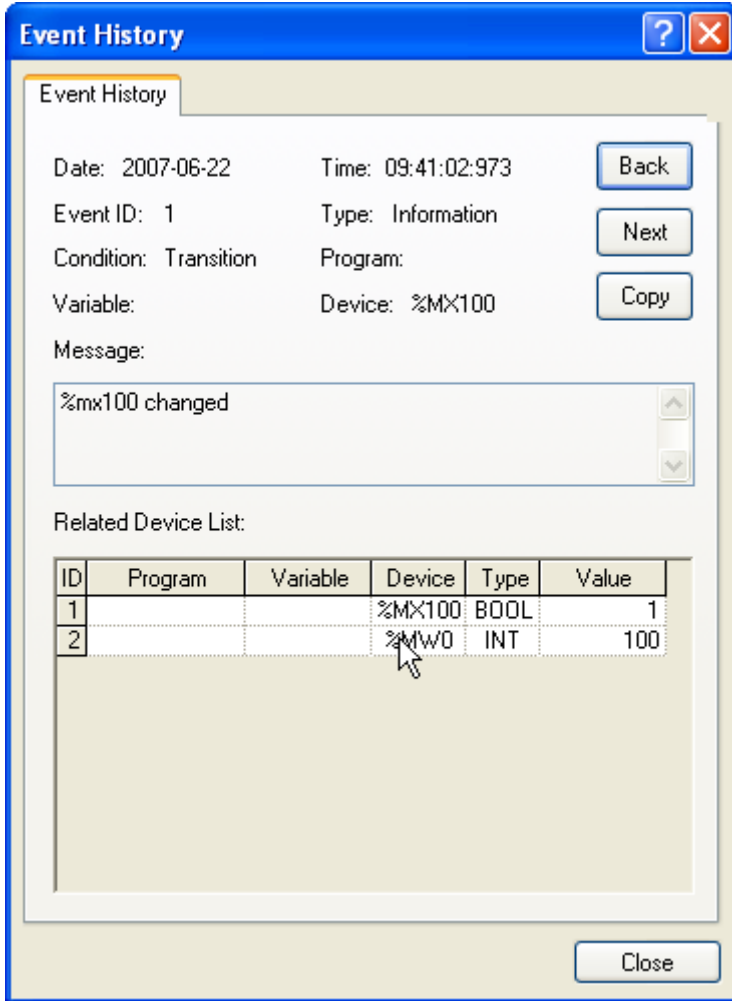

## 10.17.2 Event Setting

[Steps]

1. Select [Monitor] - [Custom Events].
2. Click the event setting tab on the user event dialog box.

[Dialog Box]

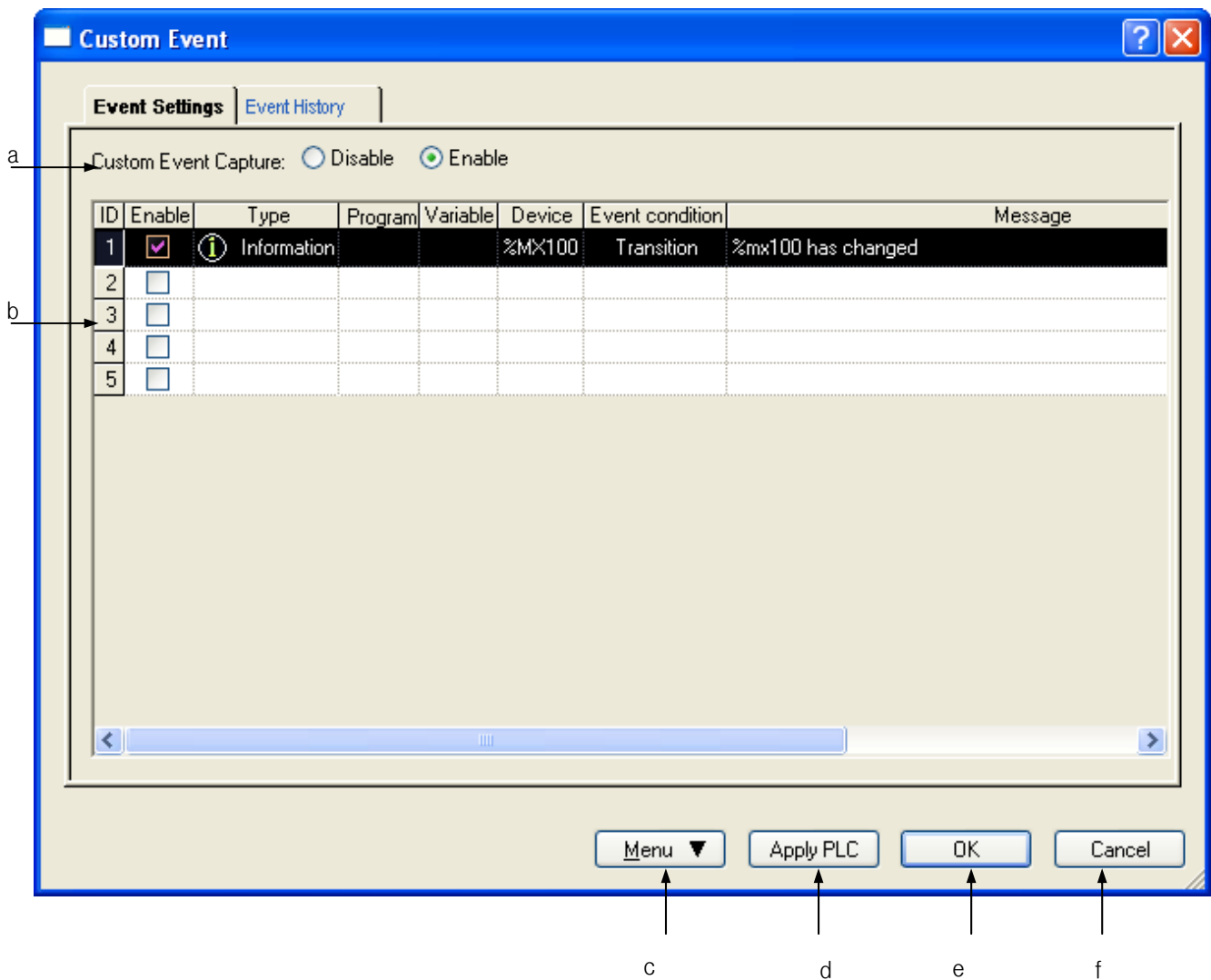

## Chapter 10 Online

[Description of Dialog Box]

- a. Custom Event capture: used to decide to allow the user event or not. If the event is disabled, PLC does not collect the Custom Events.
- b. Events History: displays the list of the Custom Events presently specified.

### Notes

- Refer to 1) User Event Item Add for details on each item of the events list.

- c. Menu button: displays the event setting menu.
- d. Apply PLC: applies the changed items to PLC without closing the Dialog Box.
- e. OK: applies the changed items and closes the Dialog Box.
- f. Cancel: closes the Dialog Box.

### 1) Custom Event Item Add

[Steps]

1. Select [Add Event].
2. Select the basic setting tab.

[Dialog Box]

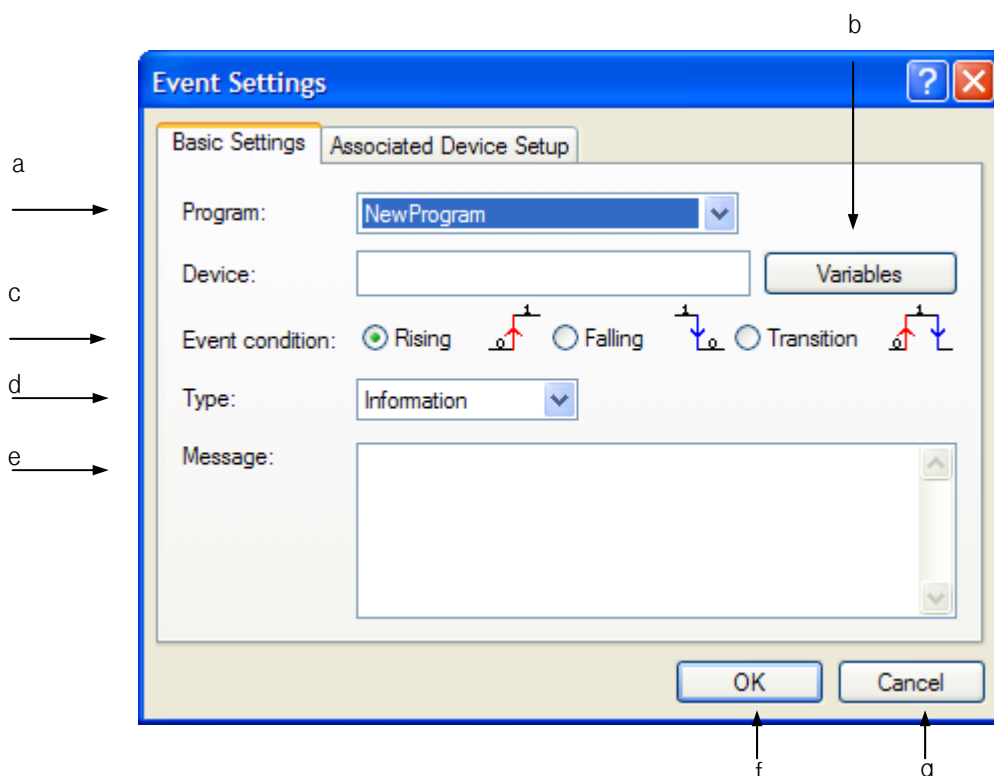

[Description of Dialog Box]

- a. Device: used to input the device to monitor the events. The event device shall be of the value 0 or 1 in bit format only.

#### Notes

- Refer to Chapter 4 Variable/Comment for details on device type and display format.

- b. Variables: displays Variable/Comment Dialog Box. The device can be selected from Variable/Comment declared in the Variable/Comment Dialog Box.
- c. Event condition: used to specify the condition to make the user event occur. If rising condition selected, the user event will occur when the event device value changes from 0 to 1. And if falling condition selected, the user event will occur when the event device value changes from 1 to 0. If transition condition selected, the user event will occur whenever the event device value changes.
- d. Type: used to specify the user event type. An applicable type can be selected among Information, Alarm and Warning.

#### Notes

- Event type is specified by user based on the importance of the event and is used as a classifying method of events for Event View.
- Refer to 10.17.2 Event History for more details.

- e. Message: used to input an event message. The maximum length of the message is 80 characters in English) (40 in Korean). The event message input is displayed with Event History menu.
- f. OK: applies the changed items and closes the Dialog Box.
- g. Cancel: closes the Dialog Box.

3. Used to input event device. Or click the Variable/Comment button to select the device from the declared Variable/Comment.
4. Specifies event conditions.
5. Specifies event type.
6. Used to input an event message.
7. Select the Associated devices setting tap to specify the Associated devices.

[Dialog Box]

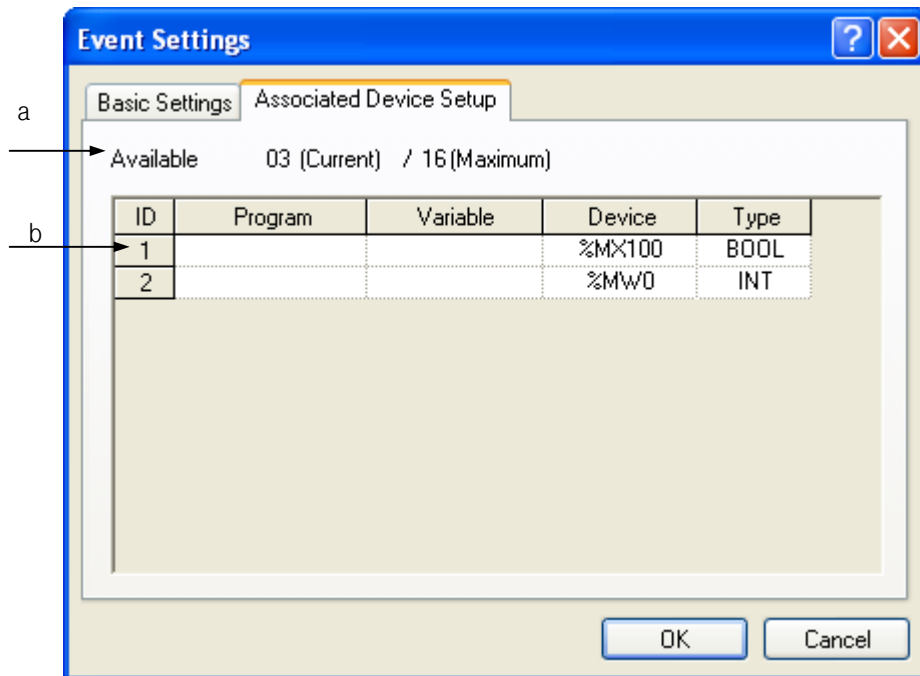

[Description of Dialog Box]

- a. Available: displays the sum of the size of the each Associated device type input, which is available up to 16 bytes.
- b. Associated devices list: used to input the Associated devices. Up to 8 Associated devices can be input.

**Notes**

- If related devices are specified, the value of the related devices will be also recorded when applicable events happen.
- Up to 8 related devices can be specified in up to 16 bytes based on the data type of the device input. Supported data type and its respective byte size are as shown below.

Type	Size	Type	Size
BIT	1 Byte	REAL	4 Bytes
USINT	1 Byte	LREAL	8 Bytes
UINT	2 Bytes	INT	2 Bytes
UDINT	4 Bytes	DINT	4 Bytes
ULINT	8 Bytes	LINT	8 Bytes

8. Click [OK] to save the input items, or click Cancel to cancel it.

**Notes**

- Up to 10 custom events is available to register.

2) Edit Event

It is used to edit the user event items input.

[Steps]

1. Select the event to edit.

ID	Enable	Type	Program	Variable	Device	Event condition	Message
1	<input checked="" type="checkbox"/>	 Information			%MX100	Transition	%mx100 has changed
2	<input type="checkbox"/>						
3	<input type="checkbox"/>						
4	<input type="checkbox"/>						

2. Select [Edit Event].

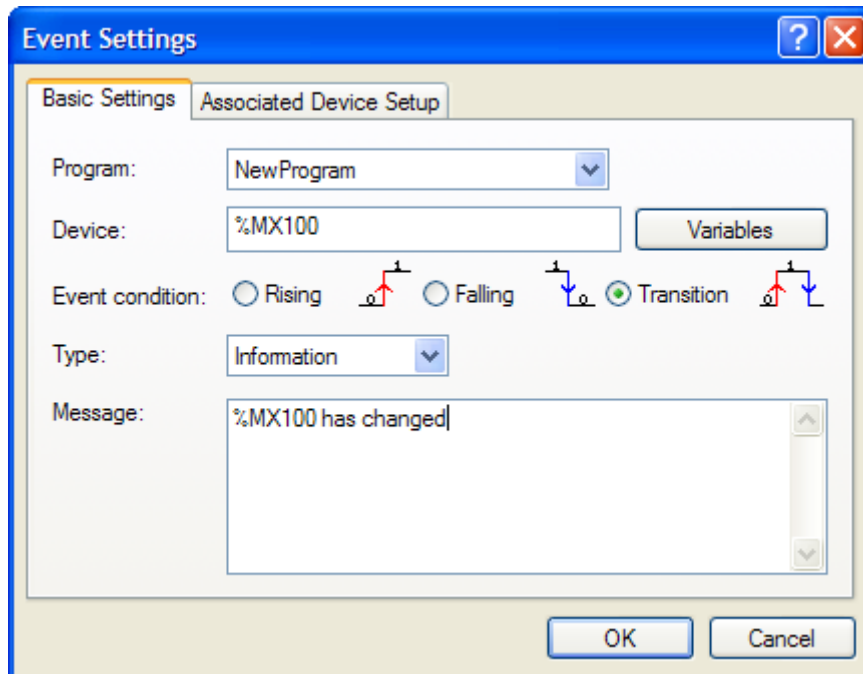

3. Click [OK] to apply the changed items, or click Cancel to cancel it.

### 3) Delete Event

It deletes the user event input.

[Steps]

1. Select the event to delete.

ID	Enable	Type	Program	Variable	Device	Event condition	Message
1	<input checked="" type="checkbox"/>	Information			%MX100	Transition	%mx100 has changed
2	<input checked="" type="checkbox"/>	Alarm			%MX100	Rising	
3	<input type="checkbox"/>						
4	<input type="checkbox"/>						

2. Select [delete].

ID	Enable	Type	Program	Variable	Device	Event condition	Message
1	<input checked="" type="checkbox"/>	Information			%MX100	Transition	%mx100 has changed
2	<input type="checkbox"/>						
3	<input type="checkbox"/>						



#### 4) Event Allowance

It is used to decide to allow all custom events or not.

[Steps]

1. Click Enable to allow the event, or click Disable not to allow.



#### 5) Event Allowance Setting

Each event will be decided to be enabled or not.

[Steps]

1. Select the event to make enabled.

ID	Enable	Type	Program	Variable	Device	Event condition	Message
1	<input checked="" type="checkbox"/>	Information			%MX100	Transition	%mx100 has changed
2	<input checked="" type="checkbox"/>	Information			%MX120	Rising	
3	<input checked="" type="checkbox"/>	Warning			%MX0	Rising	
4	<input type="checkbox"/>						

2. Select the Event Allowance column. If the event is enabled,  will be displayed, and if disenabled,  will be displayed.

ID	Enable	Type	Program	Variable	Device	Event condition	Message
1	<input checked="" type="checkbox"/>	Information			%MX100	Transition	%mx100 has changed
2	<input checked="" type="checkbox"/>	Information			%MX120	Rising	
3	<input type="checkbox"/>	Warning			%MX0	Rising	
4	<input type="checkbox"/>						

#### 6) Custom Event Copy/Paste



[Steps]

1. Select the event to copy.





ID	Enable	Type	Program	Variable	Device	Event condition	Message
1	<input checked="" type="checkbox"/>	Information			%MX100	Transition	%mx100 has changed
2	<input checked="" type="checkbox"/>	Information			%MX120	Rising	
3	<input checked="" type="checkbox"/>	Warning			%MX0	Rising	
4	<input type="checkbox"/>						

## Chapter 10 Online

2. Move to the position to paste on.

ID	Enable	Type	Program	Variable	Device	Event condition	Message
1	<input checked="" type="checkbox"/>	 Information			%MX100	Transition	%mx100 has changed
2	<input checked="" type="checkbox"/>	 Information			%MX120	Rising	
3	<input checked="" type="checkbox"/>	 Warning			%MX0	Rising	
4	<input type="checkbox"/>						
5	<input type="checkbox"/>						



3. Select [Paste].

ID	Enable	Type	Program	Variable	Device	Event condition	Message
1	<input checked="" type="checkbox"/>	 Information			%MX100	Transition	%mx100 has changed
2	<input checked="" type="checkbox"/>	 Information			%MX120	Rising	
3	<input type="checkbox"/>	 Warning			%MX0	Rising	
4	<input type="checkbox"/>	 Warning			%MX0	Rising	
5	<input type="checkbox"/>						



### 7) Custom Event Cut/Paste

[Steps]

1. Select the event to cut.

ID	Enable	Type	Program	Variable	Device	Event condition	Message
1	<input checked="" type="checkbox"/>	 Warning			%MX0	Rising	
2	<input checked="" type="checkbox"/>	 Warning			%MX0	Rising	
3	<input checked="" type="checkbox"/>	 Information			%MX100	Rising	
4	<input type="checkbox"/>						
5	<input type="checkbox"/>						

2. Select [Cut].

ID	Enable	Type	Program	Variable	Device	Event condition	Message
1	<input checked="" type="checkbox"/>	 Warning			%MX0	Rising	
2	<input checked="" type="checkbox"/>	 Warning			%MX0	Rising	
3	<input type="checkbox"/>						
4	<input type="checkbox"/>						
5	<input type="checkbox"/>						

3. Move to the position to paste on.

ID	Enable	Type	Program	Variable	Device	Event condition	Message
1	<input checked="" type="checkbox"/>	Warning			%MX0	Rising	
2	<input checked="" type="checkbox"/>	Warning			%MX0	Rising	
3	<input type="checkbox"/>						
4	<input type="checkbox"/>						
5	<input type="checkbox"/>						

4. Select [Paste].

ID	Enable	Type	Program	Variable	Device	Event condition	Message
1	<input checked="" type="checkbox"/>	Warning			%MX0	Rising	
2	<input checked="" type="checkbox"/>	Warning			%MX0	Rising	
3	<input checked="" type="checkbox"/>	Information			%MX100	Rising	
4	<input type="checkbox"/>						
5	<input type="checkbox"/>						

### 8) Delete All

[Steps]

1. Select [Delete All].

ID	Enable	Type	Program	Variable	Device	Event condition	Message
1	<input checked="" type="checkbox"/>	Warning			%MX0	Rising	
2	<input type="checkbox"/>	Warning			%MX0	Rising	
3	<input checked="" type="checkbox"/>	Information			%MX100	Rising	
4	<input type="checkbox"/>						
5	<input type="checkbox"/>						

ID	Enable	Type	Program	Variable	Device	Event condition	Message
1	<input type="checkbox"/>						
2	<input type="checkbox"/>						
3	<input type="checkbox"/>						
4	<input type="checkbox"/>						
5	<input type="checkbox"/>						

### 9) Save Event

Since the user defined event is saved in PLC, it shall be additionally saved to manage as files.

[Steps]

1. Select [Save Event].
2. Input a file name to save with on File Save Dialog Box and click [OK].

### 10) Open Event

It read user defined event setting from the file.

[Steps]

1. Select [Open Event].
2. Select a file to read and then click [OK] button.

#### Notes

- The event if opened will be added to the list of the present events..
- Up to 10 events is available. More than 10 will not be added to the list.

### 10.17.3 Event History

It reads the user event history saved in PLC to display its applicable details.

[Steps]

1. Select [Monitor] [Custom Event].
2. Select the Event History tab on the user event dialog box.

[Dialog Box]

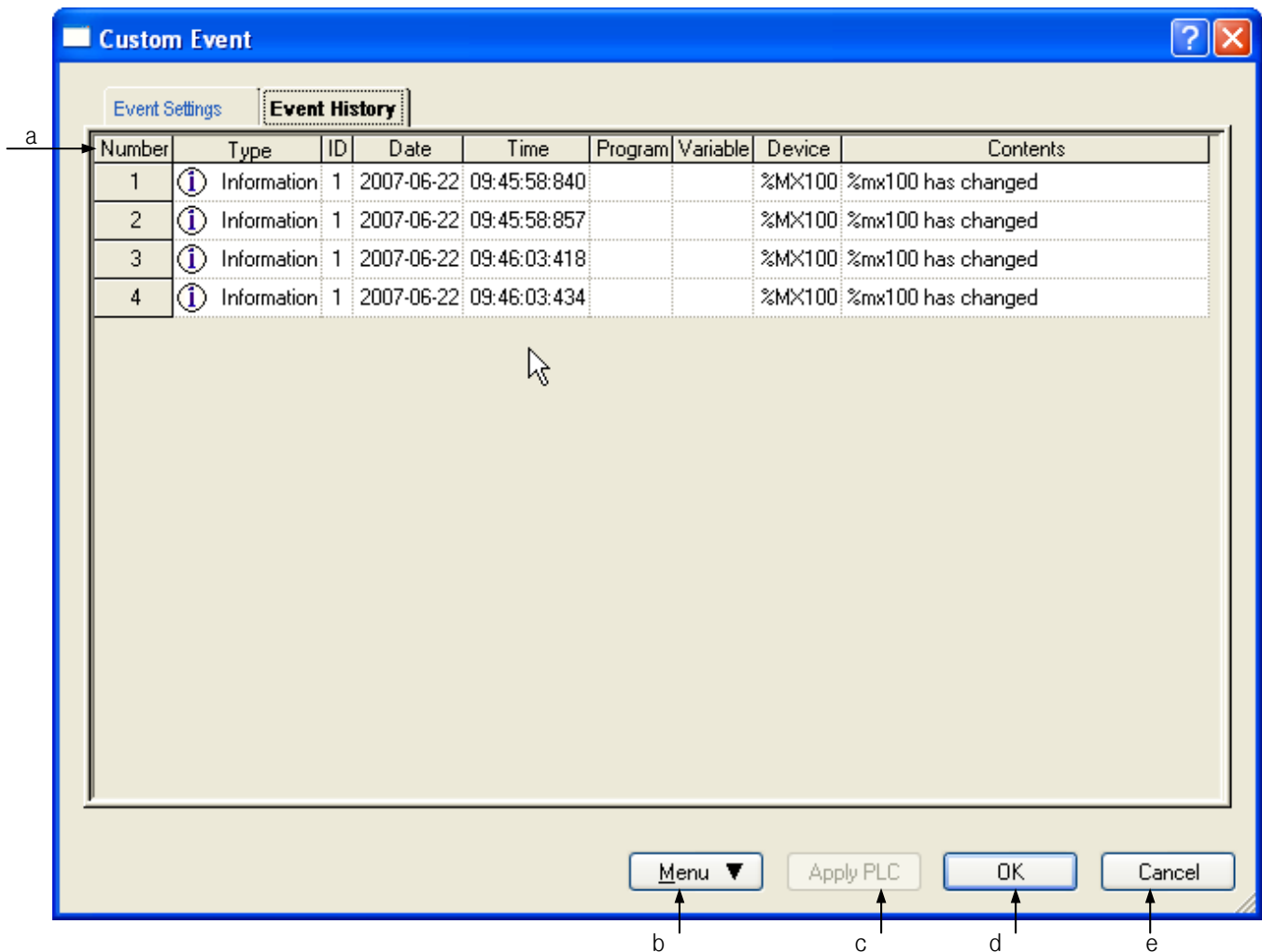

[Description of Dialog Box]

- a. Event History List: displays the event history found on PLC.
- b. Menu: displays the event history-related menu.
- c. Apply PLC: inactive on the event history page.
- d. OK: applies the changed items and closes the Dialog Box.
- e. Cancel: closes the Dialog Box.

### Notes





- Refer to 1) Detailed Event History for the respective event history item.

### 1) Detailed Event History View

It displays the details of the event.

[Steps]

1. Select the item to display its Event History.

Number	Type	ID	Date	Time	Program	Variable	Device	Contents
1	 Information	1	2007-06-22	09:45:58:840			%MX100	%mx100 has changed
2	 Information	1	2007-06-22	09:45:58:857			%MX100	%mx100 has changed
3	 Information	1	2007-06-22	09:46:03:418			%MX100	%mx100 has changed
4	 Information	1	2007-06-22	09:46:03:434			%MX100	%mx100 has changed

2. Select [Information].

[Dialog Box]

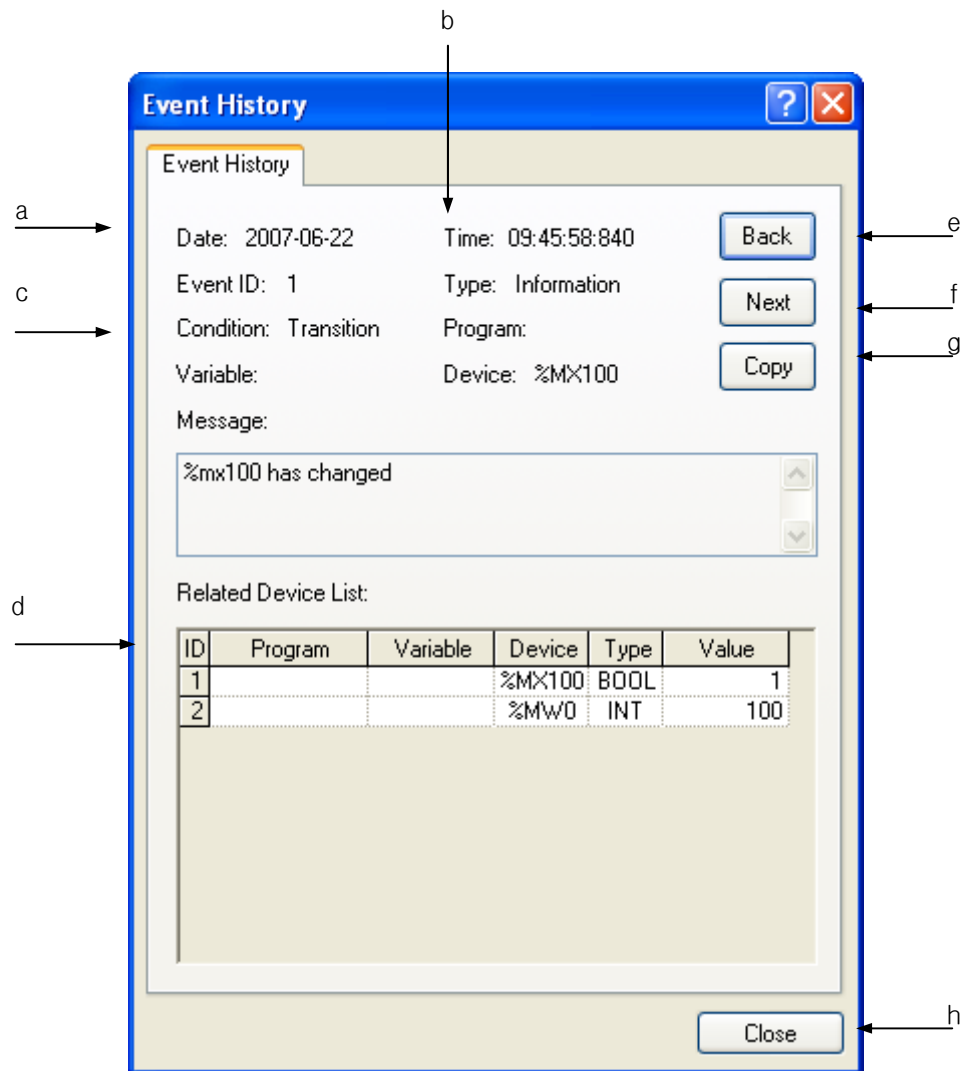

[Description of Dialog Box]

- a. Date: displays the date an event occurs in Year-Month-Date.
- b. Time: displays the time an event occurs in Hour: Minute: Second: MS.
- c. Condition: displays event details specified in event setting items.

#### Notes

- Refer to 1) Custom Event Items Additional of 10.17.2 for details on the respective event setting item.

- d. Related devices list: displays the Associated devices list and the value when the event happened. The display format of the device value can be changed with the right mouse button clicked on [View in hexadecimal] or [View as specified].
- e. Back: displays the previous event history.
- f. Next: displays the next event history.
- g. Copy: copies the present event history.
- h. Close: closes the Dialog Box.

### 2) Refresh

It updates the event history as recent details in PLC.

[Steps]











1. Select [Refresh].

### 3) Event Filtering

The history can be displayed on the event type.

[Step: View All]





1. Select [View All].

Number	Type	ID	Date	Time	Program	Variable	Device	Contents
1	 Information	1	2007-06-22	10:05:28:934			%MX100	%mx100 has changed
2	 Warning	2	2007-06-22	10:05:28:934			%MX100	
3	 Alarm	3	2007-06-22	10:05:28:934			%MX100	
4	 Information	1	2007-06-22	10:05:28:951			%MX100	%mx100 has changed
5	 Warning	2	2007-06-22	10:05:28:951			%MX100	
6	 Information	1	2007-06-22	10:05:33:559			%MX100	%mx100 has changed
7	 Warning	2	2007-06-22	10:05:33:559			%MX100	
8	 Alarm	3	2007-06-22	10:05:33:559			%MX100	
9	 Information	1	2007-06-22	10:05:33:576			%MX100	%mx100 has changed
10	 Warning	2	2007-06-22	10:05:33:576			%MX100	







[Step: View Information]

2. Select [View Information].

Number	Type	ID	Date	Time	Program	Variable	Device	Contents
1	 Information	1	2007-06-22	10:05:28:934			%MX100	%mx100 has changed
4	 Information	1	2007-06-22	10:05:28:951			%MX100	%mx100 has changed
6	 Information	1	2007-06-22	10:05:33:559			%MX100	%mx100 has changed
9	 Information	1	2007-06-22	10:05:33:576			%MX100	%mx100 has changed



[Step: View Warning]

3. Select [View Warning].

Number	Type	ID	Date	Time	Program	Variable	Device	Contents
2	 Warning	2	2007-06-22	10:05:28:934			%MX100	
5	 Warning	2	2007-06-22	10:05:28:951			%MX100	
7	 Warning	2	2007-06-22	10:05:33:559			%MX100	
10	 Warning	2	2007-06-22	10:05:33:576			%MX100	

[Step: View Alarm]

4. Select [View Alarm].

Number	Type	ID	Date	Time	Program	Variable	Device	Contents
3	 Alarm	3	2007-06-22	10:05:28:934			%MX100	
8	 Alarm	3	2007-06-22	10:05:33:559			%MX100	

## Chapter 11 Monitoring

### 11.1 Monitoring

XG5000's monitoring functions used in common (Start/Stop Monitoring, Pause, Resume, Pausing Conditions, Change Current Value) will be described below.

#### 11.1.1 Start/Stop Monitoring

[Start Monitoring]

1. Select [Online]-[Connect] on the menu for on-line connection to PLC.
2. Select [Monitor]-[Start/Stop Monitoring] on the menu to start monitoring.
3. If LD or IL program is active, it will be now in monitoring mode changed.

#### Notes

When monitoring starts, correct value may not be monitored if PLC program and XG5000 program are discordant.

[Stop Monitoring]

1. Select [Monitor]-[Start/Stop Monitoring] on the menu to stop monitoring.

#### Notes

If already started, monitoring will end. If not started yet, monitoring will start.

## 11.1.2 Change Current Value

Selected device's current value or Forced I/O setting can be changed during monitoring

[Steps]

1. Select [Online]-[Connect] on the menu for on-line connection to PLC.
2. Select [Monitor]-[Start Monitoring] on the menu to start monitoring.
3. Select device or variable on the program or variable monitoring window.

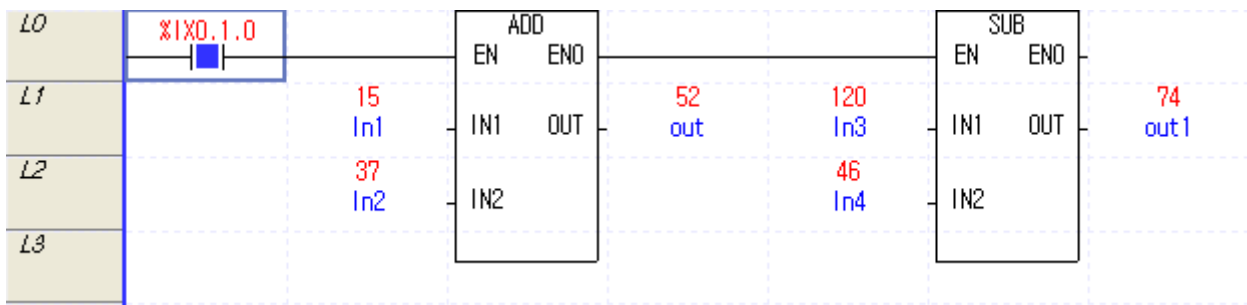

4. Select [Monitor]-[Change Current Value] on the menu.
5. Input Current Value in dialog box and select OK to change the current value.

[Dialog Box]

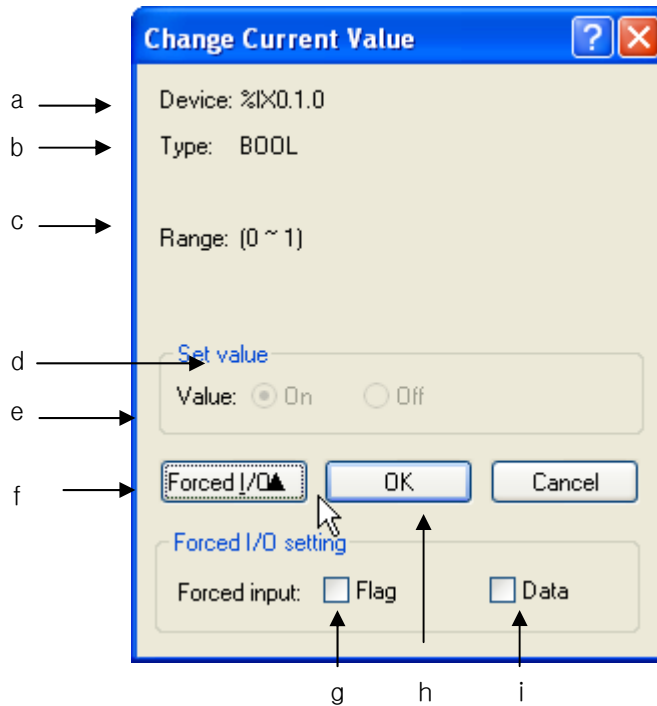

### [Description of Dialog Box]

- a. Device: Name of the variable where current value is changed.
- b. Type: Type of the variable where current value is changed.
- c. Range: Available range of current value to input based on type.
- d. Value On/Off: Device On/Off specified if its type is BOOL.
- e. Value: Variable value specified if its type is not BOOL.
- f. Forced I/O▼: Forced I/O setting available if variable is "I/Q" area and BOOL type.
- g. Flag: It is used for Forced I/O setting.
- h. OK: It is used to transfer setting value to PLC.
- i. Data: Forced I/O data value is specified.

### Notes

- a. Default of the value is displayed based on the variable's display type. In other words, if it is displayed in hexadecimal when monitored, current value changed will be too in hexadecimal.
- b. The value may not be input according to its display type. In other words, if displayed in hexadecimal, it can be input in unsigned decimal.
- c. When OK button pressed, error may occur due to ineffective input value or exceeded range inspected.
- d. Hexadecimal input shall be started with "16#" attached as shown in "16#1234".
- e. As for String type, current value (String) shall be input between single quotation marks such as ('abcde').  
- In case of WSTRING Type, input the present value(string) between double quotation marks("abcd").
- f. Only if variable is "I/Q" device and BOOL type, compulsory I/O button will be active.
- g. If compulsory I/O button is inactive, edit box of current value input and On/Off setting button will be inactive.
- h. Change Current Value and Compulsory I/O Setting will not be executed at a time.
- i. Refer to 10.13 Compulsory I/O Setting for more details on Compulsory I/O Setting.

### 11.1.3 Pause Monitoring

Monitoring can be momentarily stopped or restarted directly by user during monitoring.

#### 1) Pause Monitoring

The user can directly stop monitoring momentarily.

[Steps]

1. Select [Online]-[Connect] on the menu for on-line connection to PLC.
2. Select [Monitor]-[Start Monitoring] on the menu to start monitoring.
3. Select [Monitor]-[Pause] on the menu to stop monitoring momentarily.

#### 2) Restart Monitoring

The user can directly restart monitoring when it is momentarily stopped.

[Steps]

Select [Monitor]-[Resume] on the menu to restart monitoring.

#### Notes

- a. PLC is in Run mode, even if monitoring is momentarily stopped.
- b. Momentarily stopped monitoring only can be restarted.
- c. Monitoring value will not be renewed if program screen is moved with Pause Monitoring.
- d. If current value is changed with Pause Monitoring, PLC value will be changed but monitoring value of program screen will not be renewed.

#### 3) Pausing Conditions

If specified device meets the pausing conditions, monitoring will stop momentarily.

[Steps]

1. Select [Monitor]-[Pausing Conditions] on the menu.
2. Specify device on dialog box of Pausing Conditions.
3. Click OK to save details.

[Dialog Box]

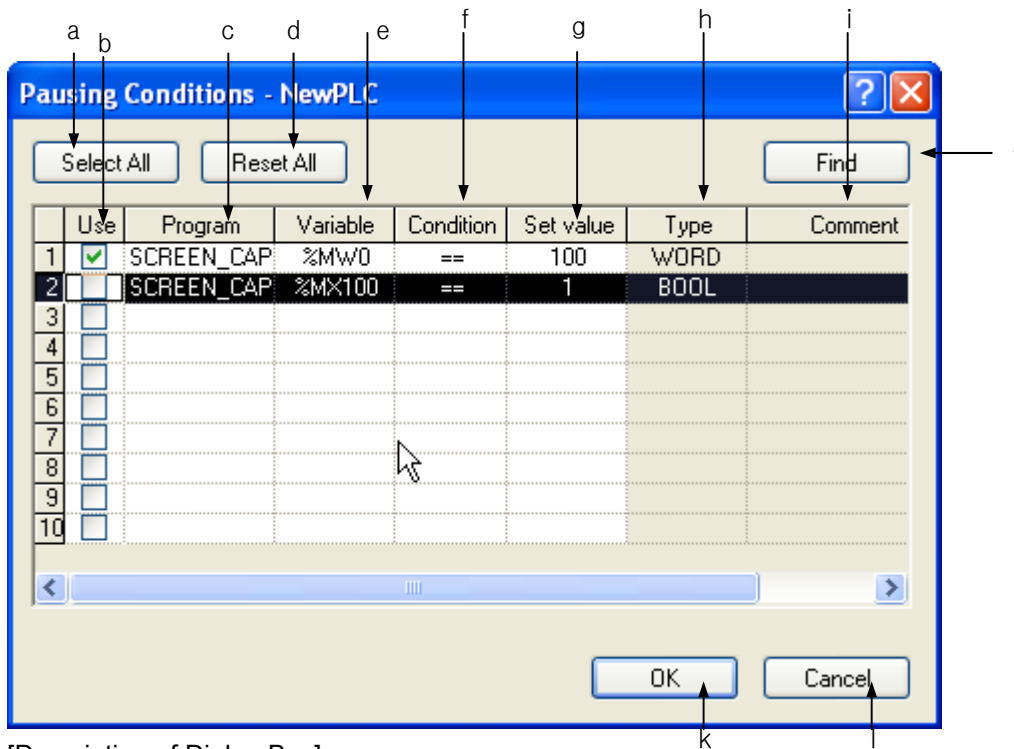

[Description of Dialog Box]

- a. Select All: used to check all items with no error to allow on the list.
- b. Use: used to check setting status of Pause Monitoring.
- c. Program: selects a program name
- d. Reset All: used to cancel all the selected items allowed.
- e. Variable: used to input variable name to stop monitoring momentarily
- f. Condition: used to select conditions to stop monitoring momentarily.
- g. Set value: used to input condition value to stop monitoring momentarily.
- h. Type: displays a variable type
- i. Comment: used to display description declared in variable.
- j. Find: used to find the variable to stop monitoring momentarily on Variable list of a selected program.
- k. OK: used to save changed details and close dialog box.
- l. Cancel: used to close dialog box without saving changed details

### Notes

- a. Conditions for Pause Monitoring can be set up to 10
- b. Items in error will not be saved even if OK button pressed.
- c. Error is displayed in pink.
- d. String type does not support the function of Pause Monitoring.
- e. Among 5 conditions [=, >, <, >=, <=] available for Pause Monitoring, one can be selected.

## 11.2 LD Program Monitoring

With XG5000 in monitoring status, it displays contact points prepared in LD diagram (ordinarily open contact point, ordinarily closed contact point, positive-converted detection contact point, negative-converted detection contact point), coils (coil, reverse-coil, set coil, reset coil, positive-converted detection coil, negative-converted detection coil) and function(block) I/O parameter's current value.

[Monitor Start Steps]

1. Select [Monitor]-[Start/Stop Monitoring] on the menu.
2. LD program will be changed to monitoring mode.

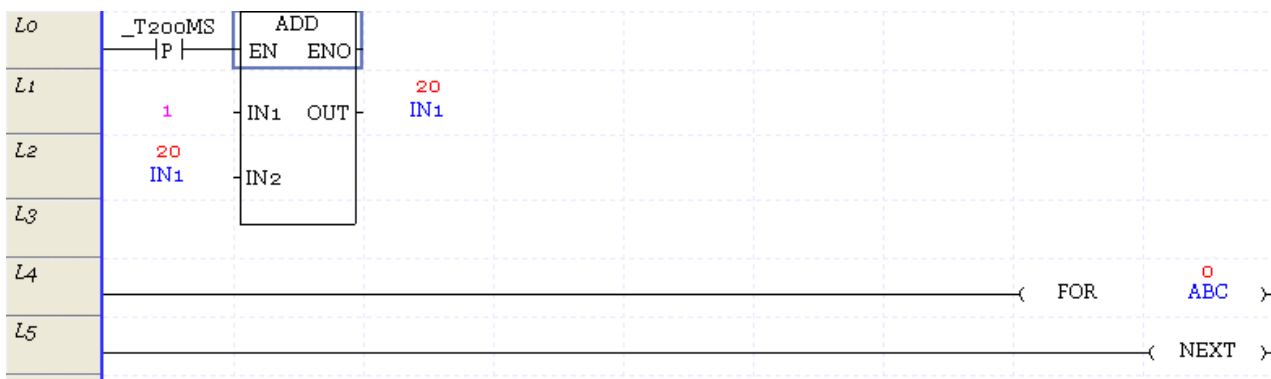

3. Change Current Value: Select [Monitor]-[Change Current Value] on the menu.

[Monitor display of contact point]

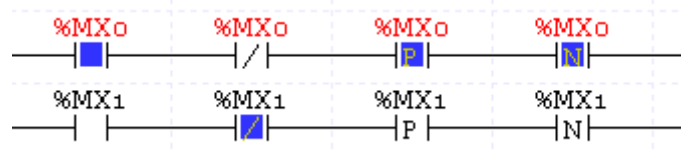

1. Ordinarily open contact point: If applicable contact point's value is On status, device (or variable) value will be displayed in red, and the power flow inside the contact point in blue

### Notes

a. Monitor-related color described in this manual is provided basically by XG5000. Applicable color may be changed on the menu [Tools]-[Options]. Refer to the option item in Chapter 2. Basic Application for more details.

2. Ordinarily closed contact point: If applicable contact point's value is On status, device value will be displayed in red, and the power flow inside the contact point will not be displayed.



## Chapter 11 Monitoring

3. Positive-converted detection contact point: displayed as identically as ordinarily open contact point.
4. Negative-converted detection contact point: displayed as identically as ordinarily closed contact point.

[Coil Monitor Display]

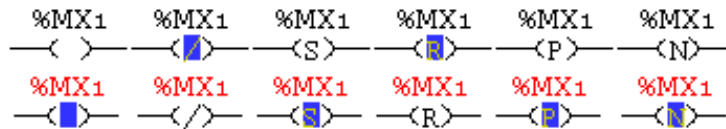

- a. Coil: If applicable coil's value is On status, device (or variable) value will be displayed in red, and the power flow inside the coil in blue.
- b. Reverse-coil: If applicable coil's value is On status, device (or variable) value will be displayed in red, and the power flow inside the coil will not be displayed.
- c. Set coil: displayed as identically as coil.
- d. Reset coil: displayed as identically as (negative) coil.
- e. Positive-converted detection coil: displayed as identically as coil.
- f. Negative-converted detection coil: displayed as identically as coil.

[Monitor Display of Function(Block)]

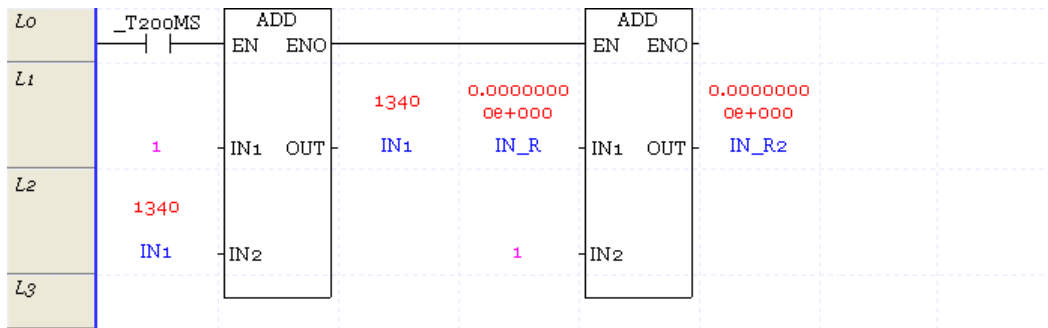

Monitoring value is displayed on the IO parameter of function(block). The data of function(block) IO parameter is displayed based on monitoring display format.

Notes

- a. Displayed data of application instruction can be specified on the menu [Tools]-[Options]-[Online]. Refer to the option item in Chapter 2 Basic Application for more details.

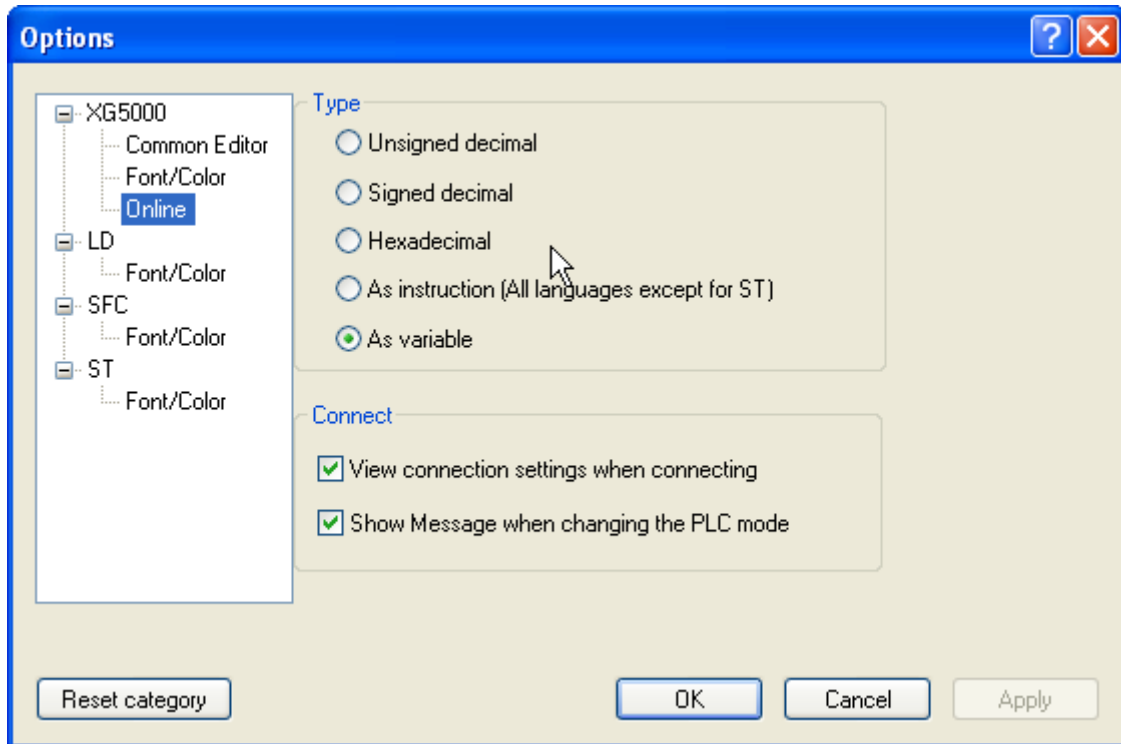

[Monitor Stop]

- 1. Select [Monitor]-[Start/Stop Monitoring] on the menu.

Notes

- a. All kinds of Edit are unavailable except Modification during Run Mode when monitored.
- b. Refer to the 1<sup>st</sup> clause of this chapter, Monitor in Common for details on Pause Monitoring and Change Current Value.
- c. When monitoring starts and stops, LD diagram height will change to display application instruction's current value, which will take some time according to the quantity of prepared program.

### 11.3 Variable Monitoring

Monitoring is available through specific variable or device registered.

[Variable Monitoring Window]

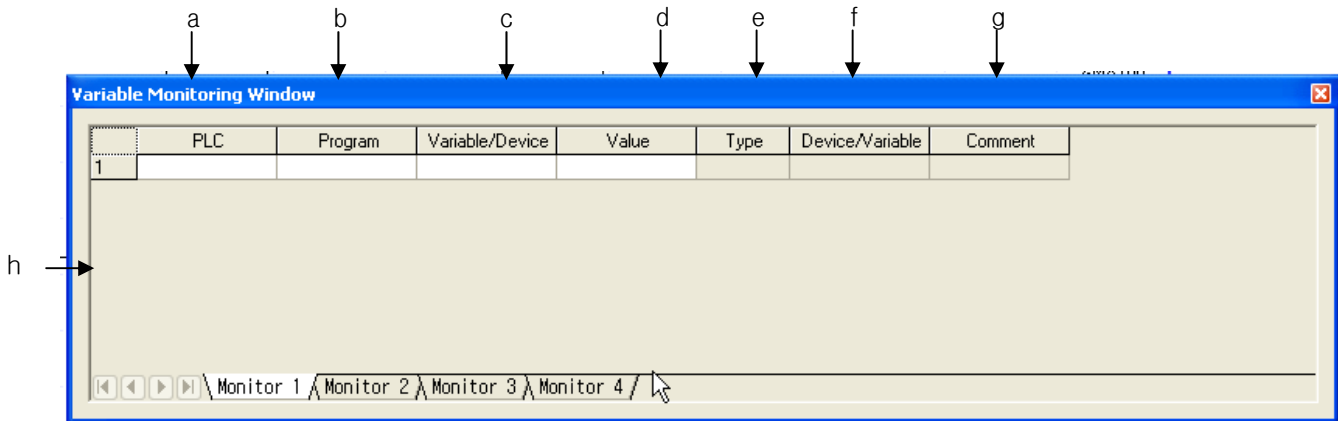

[Description of Variable Monitoring Window]

- a. PLC: used to show available PLC names to register. XG5000 can be composed of multi-PLC. Accordingly, it can be identified on the variable monitoring window.
- b. Program: used to select a program name with a variable to register.
- c. Variable/Device: used to input the name of a variable or device.
- d. Value: used to display applicable device value when monitored. The value can be changed through Change Current Value of monitoring.
- e. Type: displays the type of a variable.
- f. Device/Variable: press Enter or double-click an assigned address or variable name to select a variable on the list of local variable if memory is allocated.
- g. Comment: displays the variable comment.
- h. Error Display: Error will be displayed in red.
- i. Error type
  - In case one of PLC name, device and Type is not input
  - In case of incorrect device address
  - In case there is no program name or there is no program in the PLC
  - In case the device type is not supported or PLC name unavailable

**Notes**

- a. The areas of value, type, device/variable and comment column can not be edited by user.
- b. 4 variable monitoring taps can not be monitored at the same time.
- c. The number of devices available to register in variable monitoring is unlimited.
- d. Only the part displayed on the screen will be monitored.
- e. The larger the number of devices is, the slower the monitoring may be renewed.
- f. Even if not in monitoring mode, register is available on variable monitoring.

**11.3.1 Register Monitoring**

1) Register in Variable/Comment

Monitoring items can be registered on Local Variable list on the variable monitoring windows

[Steps]

1. On the monitoring window, click the right button of the mouse to select [Register in Variable/Comment].

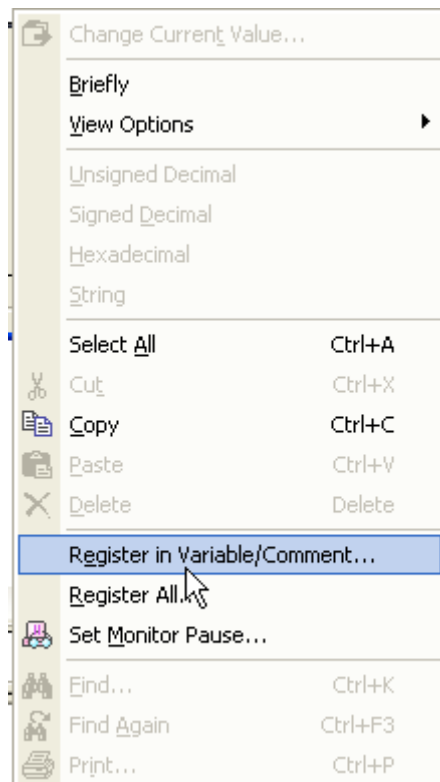

2. [Select] dialog box will appear if PLCs are 2 or more included in the project or if 2 or more programs are included in a PLC. Select the PLC and program to register.

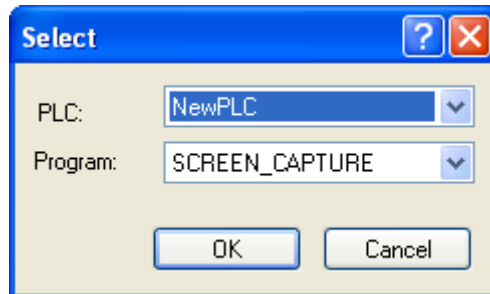

[Select Device]

3. If [Select] dialog box appears, select variables to register on the variable monitoring windows.

[Dialog Box]

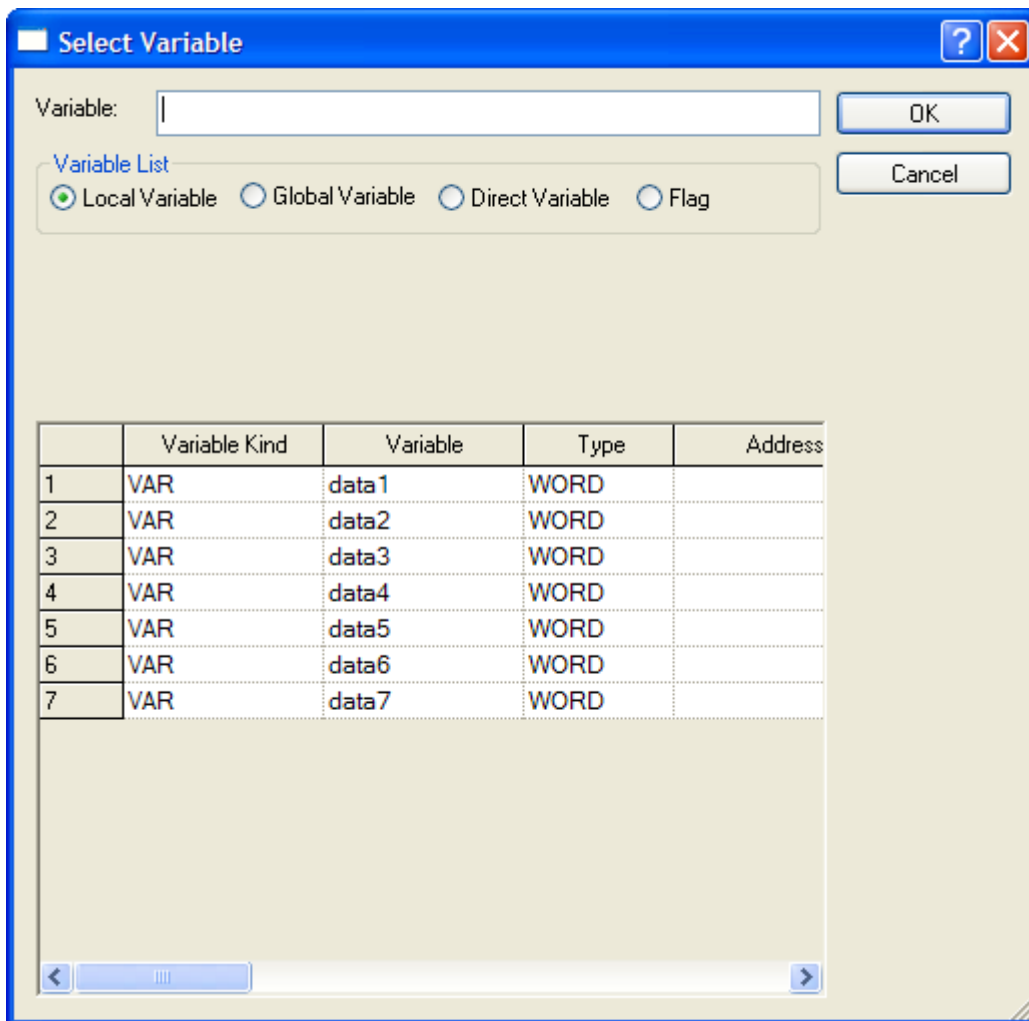

[Description of Dialog Box]

- a. Variable: inputs variable names to find.
- b. Local variable: selects local variable list
- c. List: shows local variable list
- d. OK: closes dialog box and registers at variable monitoring window
- e. Cancel: closes dialog box and doesn't registers at variable monitoring window

[Dialog box]

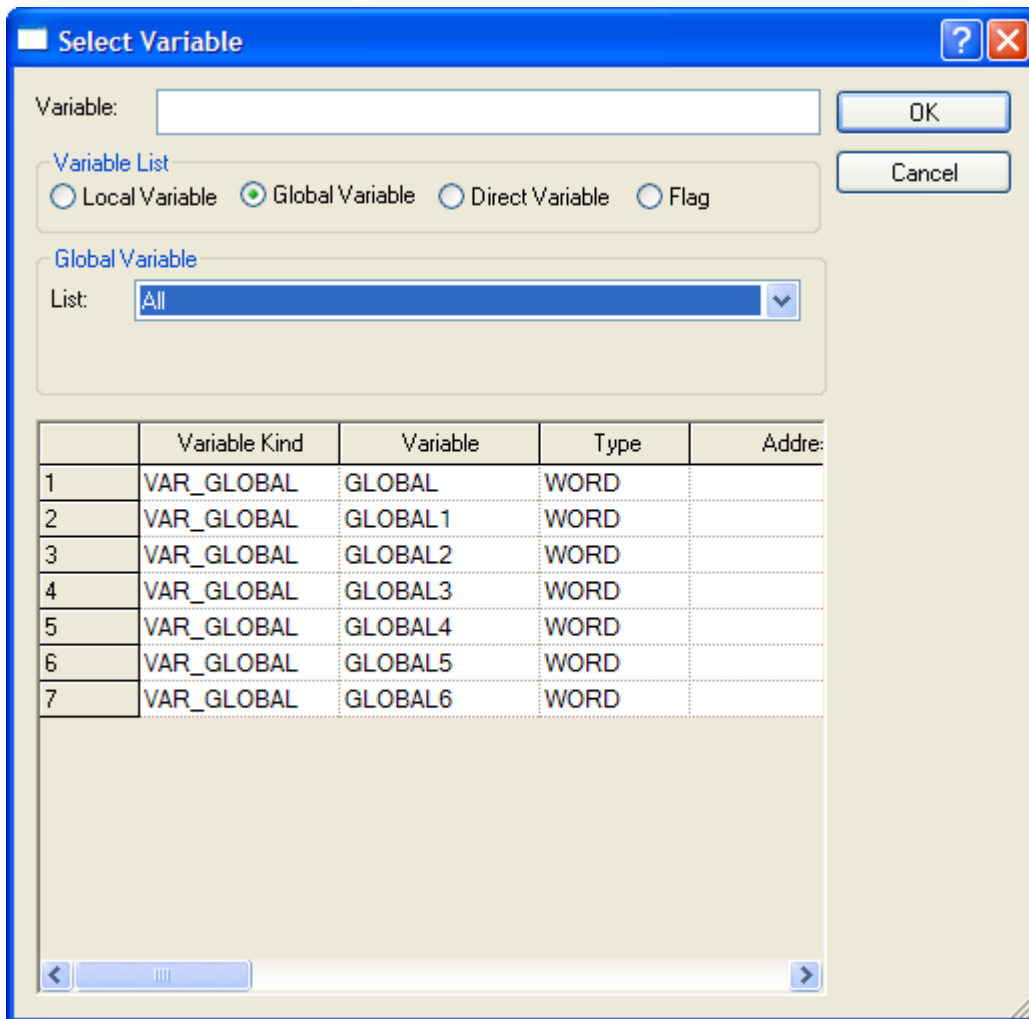

[Description of dialog box]

- Variable: inputs variable name to find
- Global variable: selects global variable list
- Global variable list: classifies global variable list into All, general variable, special module related variable.
- List: displays global variable list
- OK: closes the dialog box and registers the selected item at variable monitoring window
- Cancel: closes the dialog box and doesn't register the selected item at monitoring window

[Dialog box]

	Direct Variable	Direct Variable	Cor
1	%MX0	%MW0.0	contact1
2	%MX1	%MW0.1	contact2
3	%MX2	%MW0.2	contact3
4	%MX3	%MW0.3	contact4
5	%MX4	%MW0.4	contact5
6	%MX5	%MW0.5	contact6
7	%MX6	%MW0.6	contact7
8	%MX7	%MW0.7	contact8
9	%MX8	%MW0.8	contact9
10	%MX9	%MW0.9	contact10
11	%MX10	%MW0.10	contact11
12	%MX11	%MW0.11	contact12
13	%MX12	%MW0.12	contact13

[Description of dialog box]

- a. Variable: inputs variable name to find
- b. Direct variable: selects the direct variable list
- c. Bit View: for bit type direct variable, displays direct variable in diverse type. Displayed in Bit (X0), byte (B0.0), word (W0.0), double word (D0.0), long word (L0.0).
- d. List: displays direct variable list
- e. OK: closes the dialog box and registers the selected variable at variable monitoring window.
- f. Cancel: closes the dialog box and doesn't register at variable monitoring window.



## Chapter 11 Monitoring

[Dialog box]

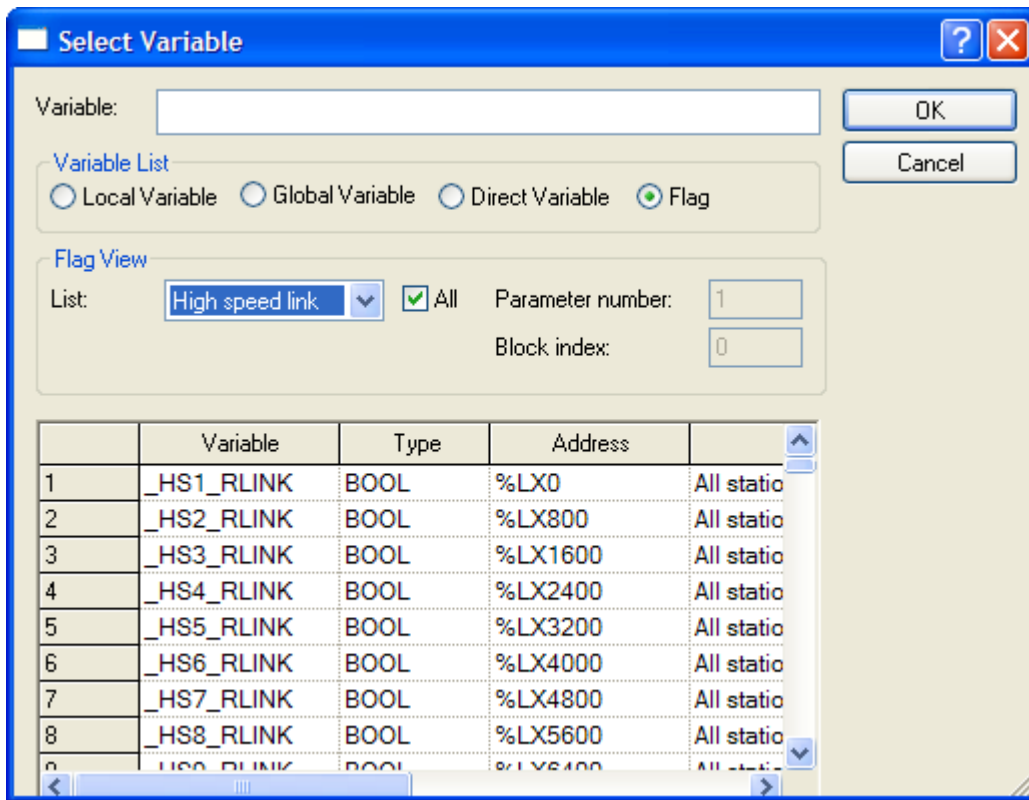

[Description of dialog box]

- Variable: inputs variable name to find
- Flag: selects flag list.
- List: as selection box for flag type, you can select system/High speed link/P2P/PID. Those can be different according to PLC type.
- All: select whether to display all flag list of the select flag or flag list based on parameter number/block index.
- Parameter number: inputs setting number per the selected flag item. For high speed link, range is 0~12. For P2P, range is 0~8. For PID, range is 0~63. Those can be different according to PLC type
- Block index: inputs block number per the selected flag item. For high speed link, range is 0~127. For P2P, range is 0~63. Those can be different according to PLC type
- List: displays the selected flag item
- OK: closes the dialog box and registers the selected variable at monitoring window.
- Cancel: closes the dialog box and doesn't register at monitoring window

### Notes

- Several items can be selected at a time on Select Variable/Device dialog box.
- The selected item is added at the last line of the variable monitoring windows.
- An item identical to previously registered item can be also registered.

### 2) Register All

Many direct variables can be registered.

#### [Steps]

- On the variable monitoring window, click the right button of the mouse to select [Register All].

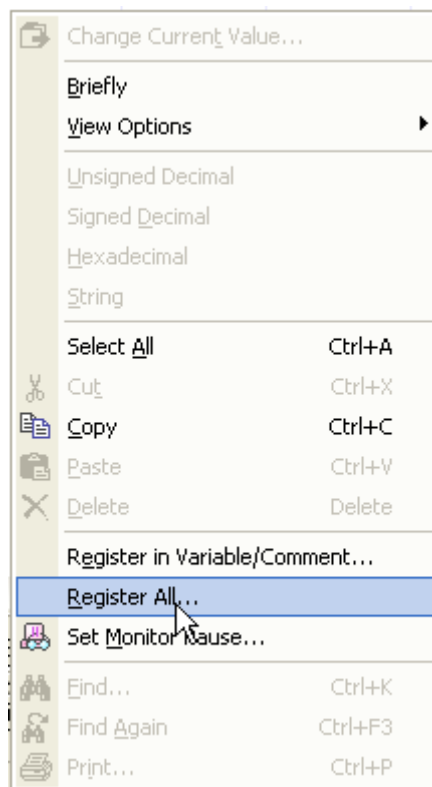

## Chapter 11 Monitoring

2. [Select] dialog box will appear if PLCs are 2 or more included in the project. Select a PLC and program to register.

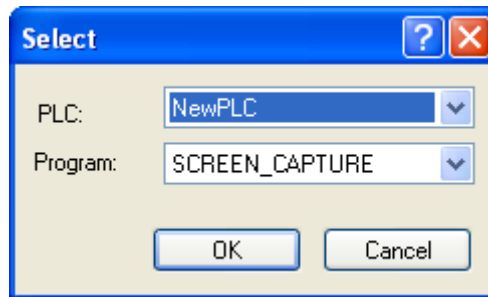

3. [Register All] dialog box will appear.

[Dialog Box]

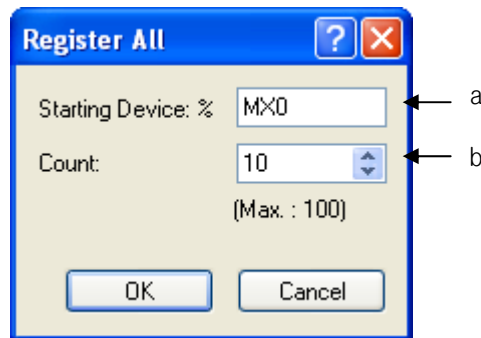

[Description of dialog box]

a. Start Device: used to input start address of the device to register.

(Device Ex: IX0.0.0, QB1.2.0. MW12...)

b. Count: used to input the number of registers as many as the registers made from the start device.

	PLC	Program	Variable/Device	Value	Type	Device/Variable	Comment
1	NewPLC	SCREEN_CAPTURE	%MX0	10			Acontact
2	NewPLC	SCREEN_CAPTURE	%MX1	10			Acontact
3	NewPLC	SCREEN_CAPTURE	%MX2	10			Acontact
4	NewPLC	SCREEN_CAPTURE	%MX3	10			Acontact
5	NewPLC	SCREEN_CAPTURE	%MX4	10			Acontact
6	NewPLC	SCREEN_CAPTURE	%MX5	10			
7	NewPLC	SCREEN_CAPTURE	%MX6	10			
8	NewPLC	SCREEN_CAPTURE	%MX7	10			
9	NewPLC	SCREEN_CAPTURE	%MX8	10			
10	NewPLC	SCREEN_CAPTURE	%MX9	10			
11							

**Notes**

- a. Up to 100 can be registered all at a time.
- b. The item to register is added at the last line of the variable monitoring windows.
- c. An item identical to previously registered item can be also registered.

3) Register by user

The user can directly input items to register on the variable monitoring windows.  
 PLC, Program and Variable/Device Column can be edited directly by user.

**Notes**

- a. Copy, Paste, Cut and Delete functions supported.
- b. Copy: available in String format on the variable monitoring windows. Paste is available onto Excel or other String editor.
- c. Paste: Paste is available onto variable monitoring after Copy from Excel or other String editor.
- d. Delete: used to delete not the selected cell but the selected row.
- e. Delete is available with several rows selected.
- f. Undo or Redo functions are not supported.

4) Drag and Drop Register from other windows

The user can select contact point, coil, variable, etc. from other windows (LD, Variable/Comment windows) to drag and drop down on the variable monitoring windows for register

[Steps]

1. Select the area from other windows (LD, SFC, Variable/Comment windows) to register on the variable monitoring.

Area to register onto the variable monitoring from LD window – Red Edge

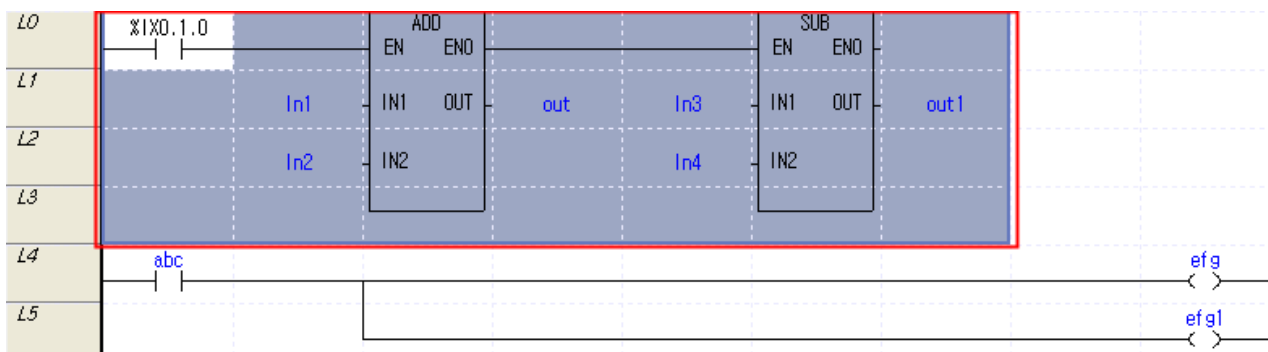

## Chapter 11 Monitoring

Area to register variable monitor in the SFC window.

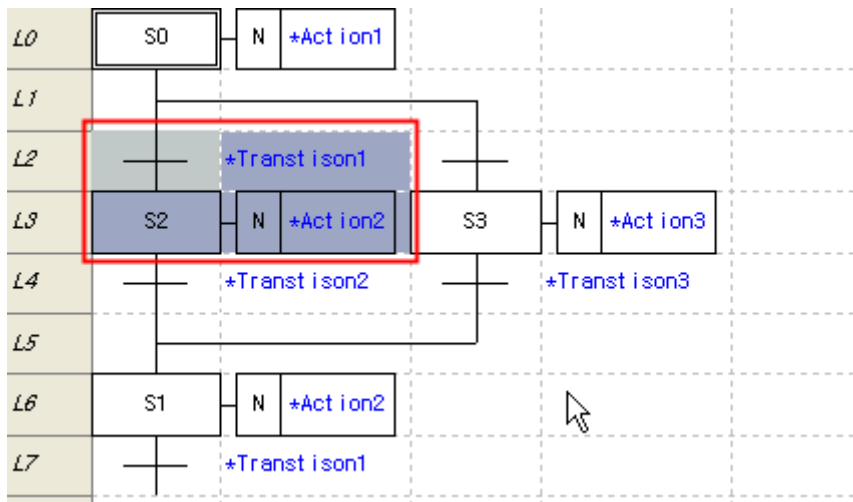

Area to register onto the variable monitoring from Variable/Comment window

	Variable Kind	Variable Name	Type	Memory Address	Initial Value	Retain	Used	Comment
1	VAR	B	BOOL			<input type="checkbox"/>	<input checked="" type="checkbox"/>	
2	VAR	C	BOOL			<input type="checkbox"/>	<input checked="" type="checkbox"/>	

2. Move onto the variable monitoring window along with the mouse's left button being pressed on the selected area.
  - Cursor shape and input image will be created if the mouse is moved onto the variable monitoring window as shown below.

	PLC	Program	Variable/Device	Value	Type	Device/Variable	Comment
1	<input type="text" value="NewPLC"/>						

3. Release the mouse left button after positioned on the row of the variable monitoring window to insert the selected items into.
4. The selected items will be registered on the variable monitoring window.

	PLC	Program	Variable/Device	Value	Type	Device/Variable	Comment
1	NewPLC	TEST	B		BOOL		
2	NewPLC	TEST	C		BOOL		
3							

### Notes

- a. The larger the number of variables to register is, the longer the registration time may be.
- b. The number of registers is unlimited.
- c. If the items are inserted in the middle of rows, they will be registered between rows.
- d. With the mouse's left button still pressed, move onto variable monitoring number taps (Monitoring 1, Monitoring 2, Monitoring 3 and Monitoring 4) to register on the applicable variable monitoring taps.

### 11.3.2 View

#### 1) Detailed/Briefly

It is a helpful function to view as many a variable as possible on the screen of the variable monitoring window.

[Steps]

1. On the variable monitoring window, select [Briefly] on the menu displayed by the right button of the mouse.
2. It will be shown as below;

	Variable/Device	Value	Variable/Device	Value	Variable/Device	Value	Variable/Device	Value
1	B		C					

Only the columns of variable/device and value are displayed.

3. Select [Detailed] again to display the following figure containing many a row.

	PLC	Program	Variable/Device	Value	Type	Device/Variable	Comment
1	NewPLC	TEST	B		BOOL		
2	NewPLC	TEST	C		BOOL		
3							

#### Notes

- a. 'Briefly' will hide the columns for PLC, Program, Type, Device/Variable and Comment.
- b. Even if in Brief View mode, the hidden columns can be viewed through View function.
- c. The number of rows is decided by the size of the variable monitoring window.
- d. In Brief View mode, the number of rows will be changed if the size of the Variable Monitoring Window changed.
- e. Even if in Brief View mode, Register, Delete and Edit functions are all available(However, Undo & Redo functions are not supported).
- f. In Brief View mode, mouse tool tips are available.
- g. Mouse tool tips can display PLC, Type and Device only. However, the variable if declared will be displayed.

	Variable/Device	Value	Variable/Device	Value	Variable/Device	Value	Variable/Device	Value
1	B		C					

PLC: NewPLC  
 Type: BOOL  
 Device: B

## Chapter 11 Monitoring

### 2) Show function

The user can select the column as desired.

[Steps]

1. On the variable monitoring window, click the right button of the mouse to select [View Option]-[Column Name (PLC, Program, Variable/Device, Value, Device/Variable, Comment)] on the menu displayed.

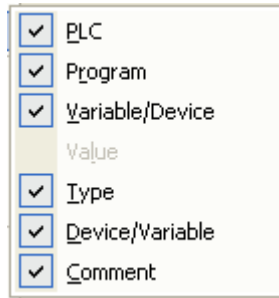

2. Hide the column selected.
3. Select again the same menu to show the column selected.

### Notes

- a. Default is Show All.
- b. This function is also available in Detailed View mode.
- c. The value column does not support Hide function.
- d. If converted to Detailed or Brief View mode, hidden columns will be displayed as default.
- e. String in the hidden columns can not be copied. Thus, the String in the hidden columns can not be pasted onto other editors.

### 3) Display

Display of the monitoring value of the device registered on the variable monitoring can be changed.

[Steps]

1. On the variable monitoring window, click the right button of the mouse to select [Unsigned Decimal, Signed Decimal, Hexadecimal and String] on the menu displayed.

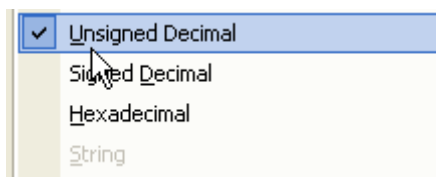

2. Display type of the device of the selected row will be changed.

**Notes**

- a. BOOL type if viewed in unsigned decimal will be displayed “On/Off”.
- b. Hexadecimal is displayed with small letter ‘16#’ as shown in “16#h10AC”.
- c. String is displayed in “”as shown in “adcd”.
- d. Separately applicable from the monitoring option.
- e. Display menus will be active or inactive based on available display type.

**11.3.3 Operation of Monitoring**

1) Start Monitoring

It is used to start the monitoring of the device registered on the variable monitoring.

[Steps]

- 1. Select [Monitor]-[Start/Stop Monitoring] on the menu.
- 2. The item with identical Start Monitoring PLC name and the item with no error will execute Monitoring.

	PLC	Program	Variable/Device	Value	Type	Device/Variable	Comment
1	NewPLC	TEST	B	10	Off	BOOL	B
2	NewPLC	TEST	C	10	Off	BOOL	C
3	NewPLC	SCREEN_CAPTURE	A	10	1323	INT	A
4							

Variable Monitoring Window being monitored

**Notes**

- a. PLC’s device value will not be displayed if not monitored.
- b. Any item with error will not be monitored.
- c. Edit, Add and Delete are available even during monitoring.

2) Change Current Value

Current value of the device can be changed in monitoring mode.



## Chapter 11 Monitoring

[Steps]

1. Select [Monitor]-[Start/Stop Monitoring] on the menu.
2. Select [Device].
3. Select [Monitor]-[Change Current Value] on the menu. Or double-click the value cell of the device selected on the variable monitoring window, or press Enter.
4. Dialog box of Change Current Value will appear, where user can directly input the current value.
5. Click OK button to transfer the setting value to PLC.

### 11.3.4 Find

#### 1) Find

It helps find string based on the classification by capital/small letter, partial accord and direction.

#### Notes

- a. On the variable monitoring, Find function is not available.
- b. On the variable monitoring, Change function is not available.
- c. Value is regarded as string not as figure when Find function is executed in the value column.

#### 2) Find Again

It is used to find again the string found before. Execute Find on the program or Variable/Comment, and then execute Find Again on the variable monitoring to start to find.

### 11.3.5 Print

It prints the variable monitoring tap presently active.

#### Notes

- a. The variable monitoring tap if not active will not be printed.
- b. Value even if being monitored can be printed.
- c. The screen will be printed as is. In other words, hidden columns can not be printed.
- d. Print Preview function is not available.

### 11.3.6 Shortcut Keys

All the operations are available with shortcut keys on the menu.

Notes	
a. Some shortcut keys can not be changed as specified by user.	
Shortcut Keys	Details
Home/End	On the variable monitoring window, select a cell to make the cursor into the cell in the column where edit is available (PLC, Device, Type Column) to be in Edit mode.
Ctrl+Home/End	Moves to the first or the last cell.
Ctrl+Arrow	Moves from the presently selected cell to the first or the last cell to the left or right, above or below.
Tab	Moves the present cell from the left to the right.
Shift+Tab	Moves the present cell from the right to the left.
Enter	Moves the present cell from above to below. If the present cell is value column during monitoring, it will change the current value as well. If the present cell is variable column, it will register on Variable/Comment.
Shift+Enter	Moves the present cell from below to above.

### 11.3.7 Alignment

Alignment can be changed to ascending or descending sequence.

[Steps]

1. Double-click the left mouse button positioned on the header of the column to align.

	PLC	Program	Variable/Device	Value	Type	Device/Variable	Comment
1	NewPLC	TEST	C	10 Off	BOOL	C	
2	NewPLC	TEST	B	10 Off	BOOL	B	
3	NewPLC	SCREEN_CAPTURE	A	10 15369	INT	A	
4							

Outlined line in the above figure

## Chapter 11 Monitoring

2. Alignment will be in ascending or descending sequence.

	PLC	Program	Variable/Device	Value ▲	Type	Device/Variable	Comment
1	NewPLC	TEST	C	10 Off	BOOL	C	
2	NewPLC	TEST	B	10 Off	BOOL	B	
3	NewPLC	SCREEN_CAPTURE	A	10 15369	INT	A	
4							

3. After aligned, an arrow figure will be displayed according to ascending or descending sequence.

### Notes

- If aligned in descending sequence, a downward arrow image will be displayed. And if aligned in ascending, an upward arrow image will be displayed.
- It is not aligned yet when the project is opened.
- If aligned once more in descending sequence, it will be aligned in ascending sequence.
- Align function in row unit (horizontally) is not available.

## 11.4 System Monitoring

System Monitoring is used to display PLC's slot information, I/O information assigned, module status and data value.

### 11.4.1 Basic Application

There are two methods available to execute System Monitoring.

- a. Select [Monitor]-[System Monitoring] on the XG5000 menu.
- b. Select [Start]-[Program]-[XG5000]-[System Monitoring] on the Start menu.

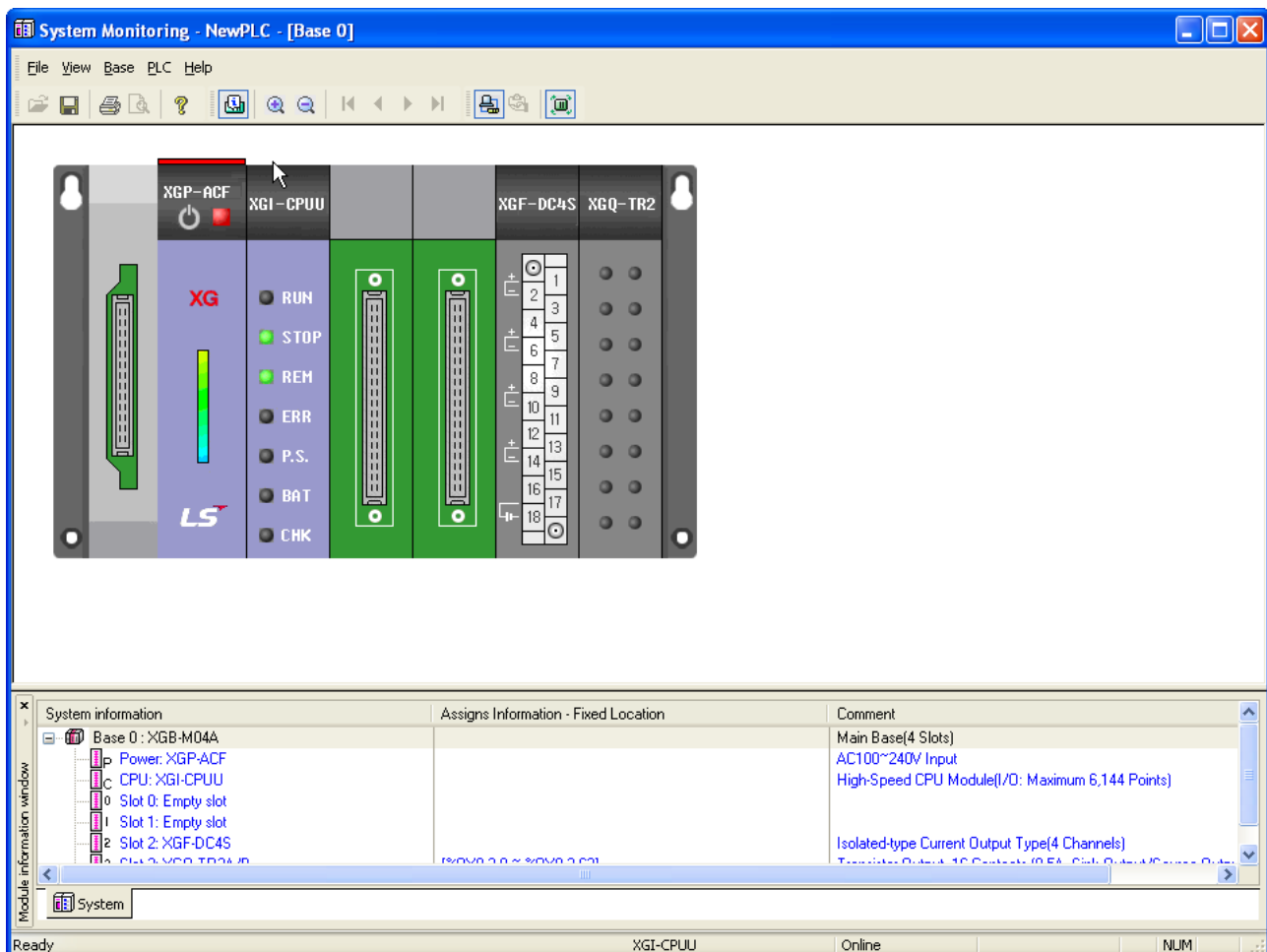

Module Information Window displays the information of the slot installed on PLC. After reading the module information saved in PLC, it displays it on the data display screen of the module information window.

Select one of those specified below to view Base.

## Chapter 11 Monitoring

- a. Select items on the module information window. (Ex. Base 0, Base 1, ...)
- b. Select [Base] items on the menu. (Select First, Previous, Next, Last base)
- c. Use the direction key on the keyboard to position the module's cursor on the base to select.

### Notes

- a. If System Monitoring is executed on the XG5000 menu, it will be in Connect and Monitoring status.

### 11.4.2 Connect/Disconnect

System Monitoring can be created by a call from XG5000, or can be also executed solely.

Thus, the connection is available to PLC with Connect options. If connected with PLC, base information is read from PLC to display on the module information window.

#### [Steps]

1. Specify Connect options.
2. Confirm that cable is installed applicably to connection method.
3. Select [PLC]-[Connect] on the menu to connect.
4. Select [PLC]-[Disconnect] on the menu to disconnect.

### Notes

- a. System Monitoring when executed will start to connect with the saved Connect options.
- b. If executed in XG5000, it will start to connect with XG5000's Connect options.
- c. Default of Base 0 will be displayed on the screen.

### 11.4.3 System Synchronization

It reads base information, I/O assignment method and slot information specified in PLC to display on the screen. When monitored, it will read I/O skip information and forced I/O input/output information to change the current value.

#### [Steps]

1. Confirm the connection status with PLC.
2. Select [PLC]-[System Synchronization] on the menu.

### Notes

- a. If the system synchronization executed, the module information only will be updated.
- b. Refer to Basic Parameter Information for details on I/O assignment method.

#### 11.4.4 All I/O modules ON/OFF

It is used to check output value of all the I/O modules installed on PLC.

##### 1) All I/O modules ON

It makes the data value of all the I/O modules installed on PLC be On.

[Steps]

1. Confirm the connection status with PLC.
2. Select [PLC]-[All I/O modules ON] on the menu.

##### 2) All I/O modules OFF

It makes the data value of all the I/O modules installed on PLC be Off.

[Steps]

1. Confirm the connection status with PLC.
2. Select [PLC]-[All I/O modules OFF] on the menu.

#### 11.4.5 Selected I/O modules ON/OFF

It is used to check output value of the selected I/O modules installed on PLC.

##### 1) Selected I/O module ON

It makes the data value be ON as many as the contact points of the selected I/O modules on the base displayed on PLC screen.

[Steps]

1. Confirm the connection status with PLC.
2. Select [PLC]-[Selected I/O modules ON] on the menu.

## Chapter 11 Monitoring

### 2) Selected I/O module OFF

It makes the data value be Off as many as the contact points of the selected I/O modules on the base displayed on PLC screen.

[Steps]

1. Confirm the connection status with PLC.
2. Select [PLC]-[Selected I/O modules OFF] on the menu.

### 11.4.6 Change Current Value

In order to change the current value, it shall be in the connection status with PLC and in monitoring mode. Click the contact point to change the data value of the selected contact point to ON or OFF.

[Steps]

1. Confirm the connection status with PLC and the monitoring mode.
2. Position the mouse cursor on the I/O module's contact point to change the cursor to hand shape.
3. Click the I/O module's contact point.

#### Notes

- a. Move the mouse onto I/O contact point to display the assigned device on the status bar.
- b. If I/O skip is specified, it will be displayed always OFF.

### 11.4.7 Information Display of Power Module

Information of Power Module displays base power-cut history including date, time and details in which power-cut bases are displayed.

[Steps]

1. Confirm the connection status with PLC.
2. Select one method among those below to display the module information.
  - a. With Power Module selected, select [PLC]-[Module Info.] on the menu.
  - b. With Power Module selected, click the right button of the mouse to select [Module Information] on the menu.
  - c. With Power Module selected on the Module Information window, click the right button of the mouse to select [Module Info.] on the menu.
  - d. If Power Module is selected on the screen, press Enter.
  - e. Double-click the mouse positioned on Power Module displayed on the screen.

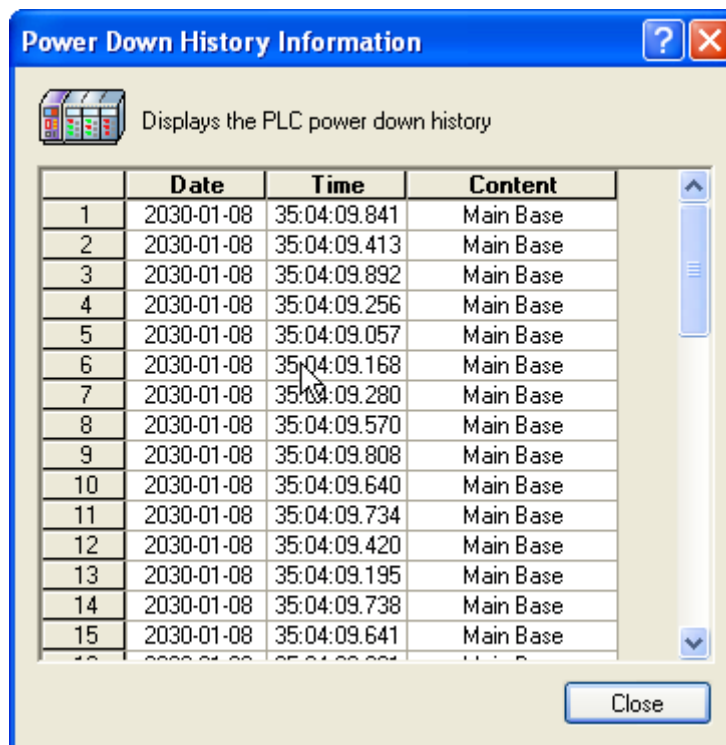



### Notes

- a. If the number of power-cuts exceeds 100, only up to 100 can be displayed on the screen.
- b. No module information is available for empty slot and I/O module.

### 11.4.8 Information Display of CPU module

Information of CPU Module displays CPU version, type, operation mode, key status, CPU status, connection status, mode conversion source, forced I/O setting status, I/O skip and Fault Mask status.

#### [Steps]

1. Confirm the connection status with PLC.
2. Select one method among those below to display the CPU module information.
  - a. With CPU Module selected, select [PLC]-[Module Info.] on the menu.
  - b. With CPU Module selected, click the right button of the mouse to select [CPU Module Info.] on the menu.
  - c. With CPU Module selected on the Module Information window, click the right button of the mouse to select [CPU Module Info.] on the menu.
  - d. If CPU Module is selected on the screen, press Enter.
  - e. Double-click the mouse positioned on CPU Module displayed on the screen.

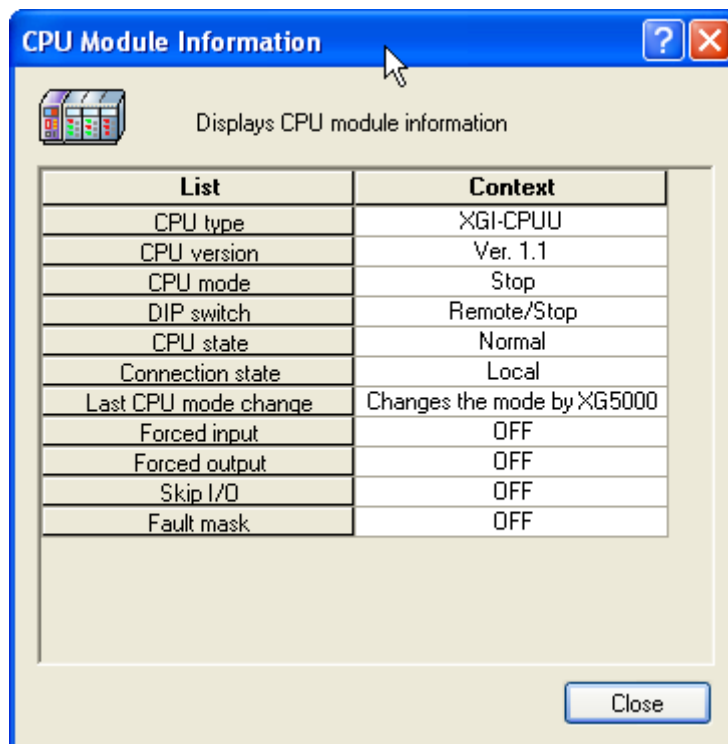

### 11.4.9 Information Display of Communication Module

Information of Communication Module displays module type, operation mode, H/W error & error version, O/S version and its installed date.

[Steps]

1. Confirm the connection status with PLC.
2. Select one method among those below to display the COM module information
  - a. With Communication Module selected, select [PLC]-[Module Info.] on the menu
  - b. With Communication Module selected, click the right button of the mouse to select [COM Module Info.] on the menu
  - c. With Communication Module selected on the Module Information window, click the right button of the mouse to select [Connection Module Info.] on the menu
  - d. If Communication Module is selected on the screen, press Enter.
  - e. Double-click the mouse positioned on Communication Module displayed on the screen.

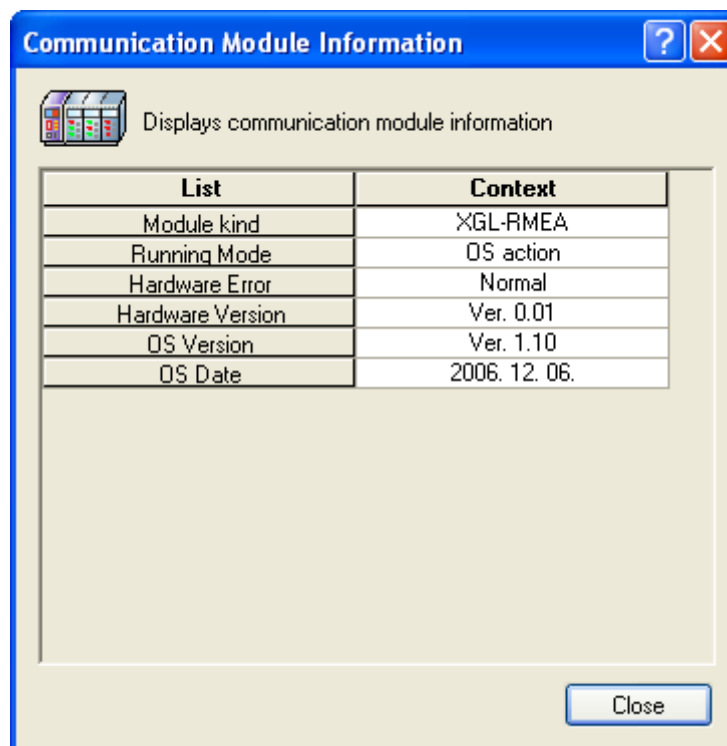

## Chapter 11 Monitoring

### 11.4.10 Information of Special Module

Information of Special Module displays module name, O/S version & date and module status.

[Steps]

1. Confirm the connection status with PLC.
2. Select one method among those below to display the special module information.
  - a. With Special Module selected, select [PLC]-[Module Information] on the menu.
  - b. With Special Module selected, click the right button of the mouse to select [Special Module Info.] on the menu.
  - c. With Special Module selected on the Module Information window, click the right button of the mouse to select [Special Module Info.] on the menu.
  - d. If Special Module is selected on the screen, press Enter.
  - e. Double-click the mouse positioned on Special Module displayed on the screen.

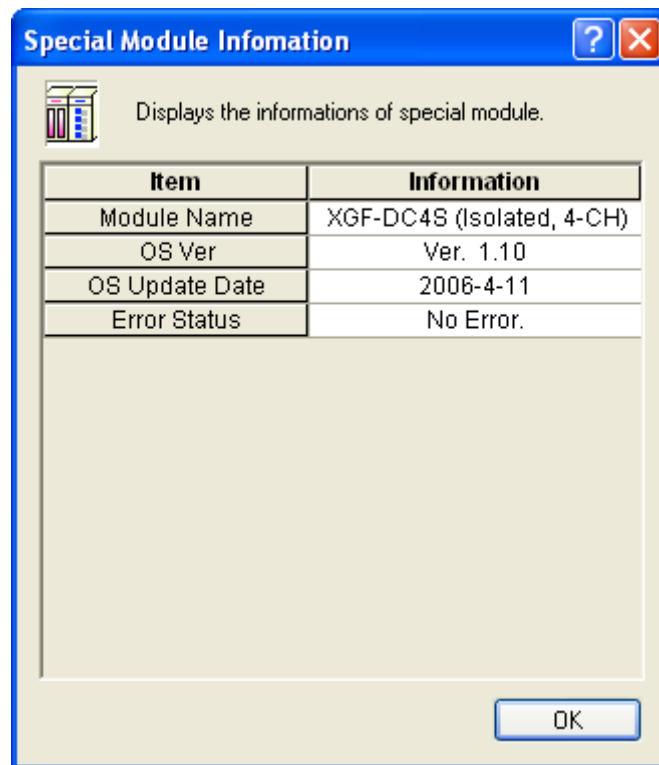

[Detailed Description]

Classification	Description
Module name	Provides special module's type and its detailed information.
O/S version	Provides special module's installed O/S version information, which will be helpfully used for upgrading module O/S later.
O/S date	Provides special module's latest O/S updated date information.
Module status	Provides special module's present status (error code) information.

### 11.4.11 Start/Stop Monitoring

It reads PLC's I/O data to display on the screen.

#### 1) Start Monitoring

[Steps]

1. Confirm the connection status with PLC.
2. Select [PLC]-[Start Monitoring] on the menu.

#### 2) Stop Monitoring

[Steps]

1. Confirm the connection status with PLC.
2. Select [PLC]-[Stop Monitoring] on the menu.

### 11.4.12 Special Module Monitoring

It executes monitoring the special module (A/D module, D/A module, HS counter module).

[Steps]

1. Confirm the connection status with PLC.
2. Select [PLC]-[Special Module Monitoring] on the menu.

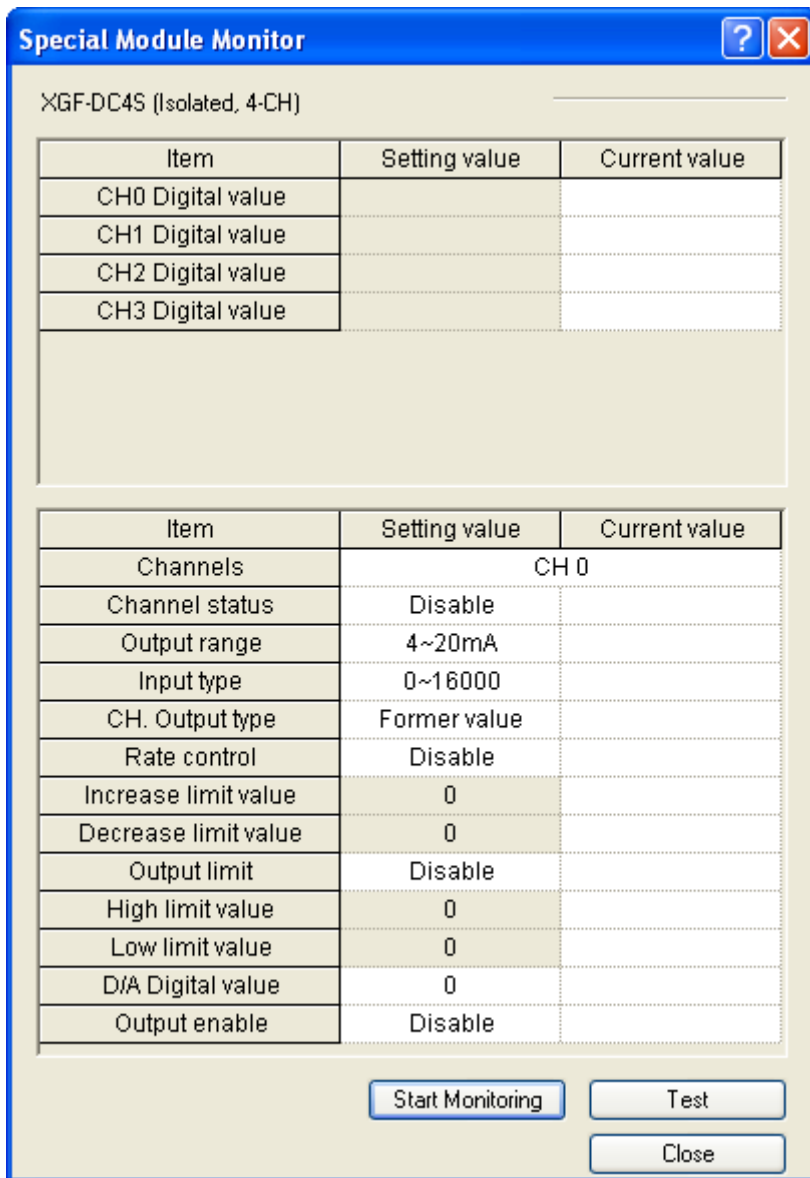

### Notes

Special Module Monitor can not be used in Positioning Module and the only module info can be used. Positioning module's monitoring function shall be applied along with its exclusive software package.

### 11.4.13 Save

It is used to save the system information and data presently displayed on the screen.

[Steps]

1. Select [File]-[Save] on the menu.
2. Select [File]-[Save As] on the menu to save the data as a different name.

#### Notes

- a. File extension will be set as (.smi).

### 11.4.14 Open

It is used to read the system information file previously saved.

[Steps]

1. Select [File]-[Open] on the menu.
  - a. Double-click an applicable file name.
  - b. Drag & drop the file onto the System Monitoring to open it.

### 11.4.15 Move Base

It selects a base to show its module information.

[Steps]

1. Move to the first base.
  - a. Select [Base]-[First Base] on the menu.
2. Move to the previous base.
  - b. Select [Base]-[Previous Base] on the menu.
3. Move to the next base.
  - c. Select [Base]-[Next Base] on the menu.
4. Move to the last base.
  - d. Select [Base]-[Last Base] on the menu.

## Chapter 11 Monitoring

### 11.4.16 Preview

This function is used to previously view the image to be printed.

On the Previous View window, the user can modify the area to be printed.

[Steps]

1. Click [Preview].
  - a. Select [File]-[Preview] on the menu.
2. Modify the area of the image displayed.
3. Move the mouse to the edge.
4. Mouse cursor will be changed.
5. Move the mouse while being clicked to modify the size.

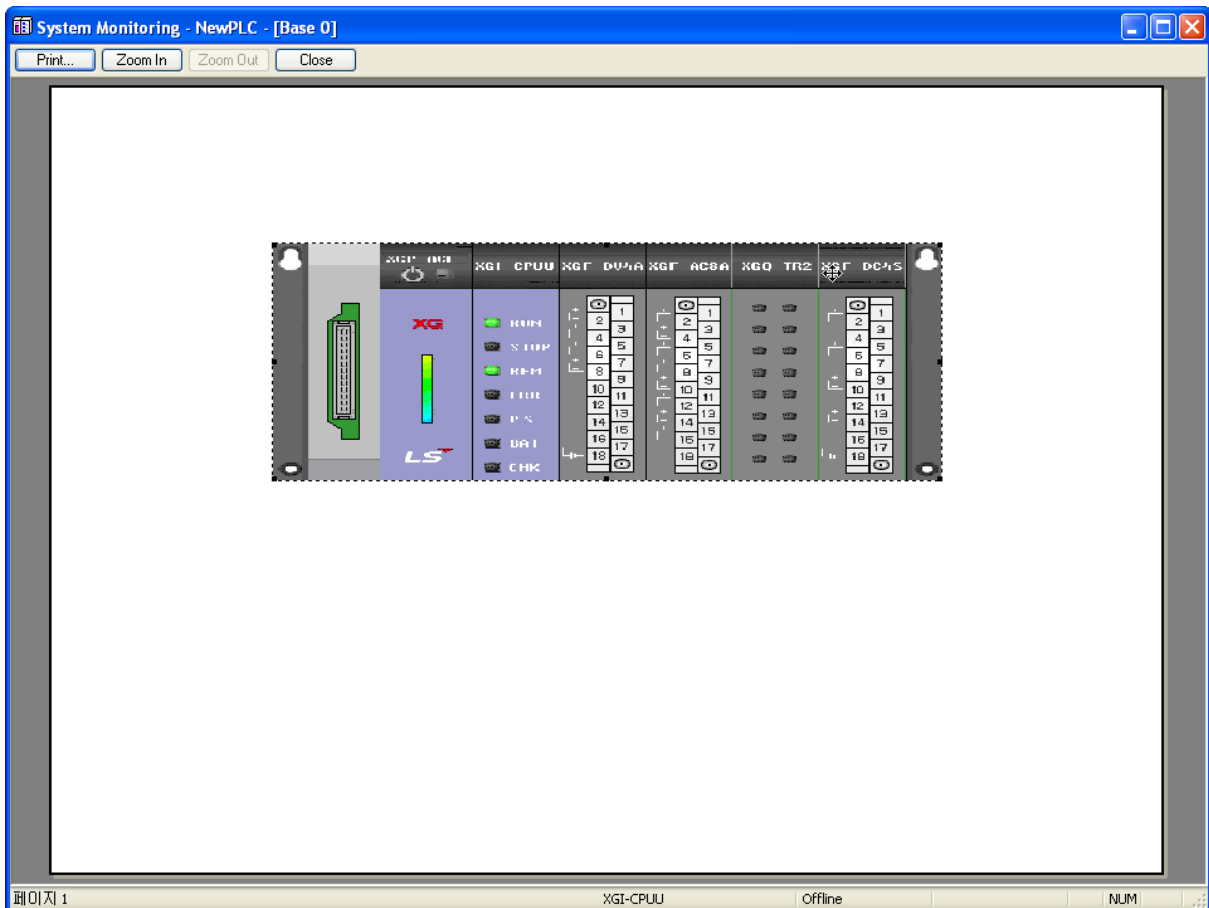

#### Notes

- a. The specified area of Preview will be saved.
- b. In monitoring mode, Preview is not available.

### 11.4.17 Hide/Show Frame

Hides or shows frame at screen

[Steps]

Select the module of system area and click the right button of mouse. Then select [Hide Frame]

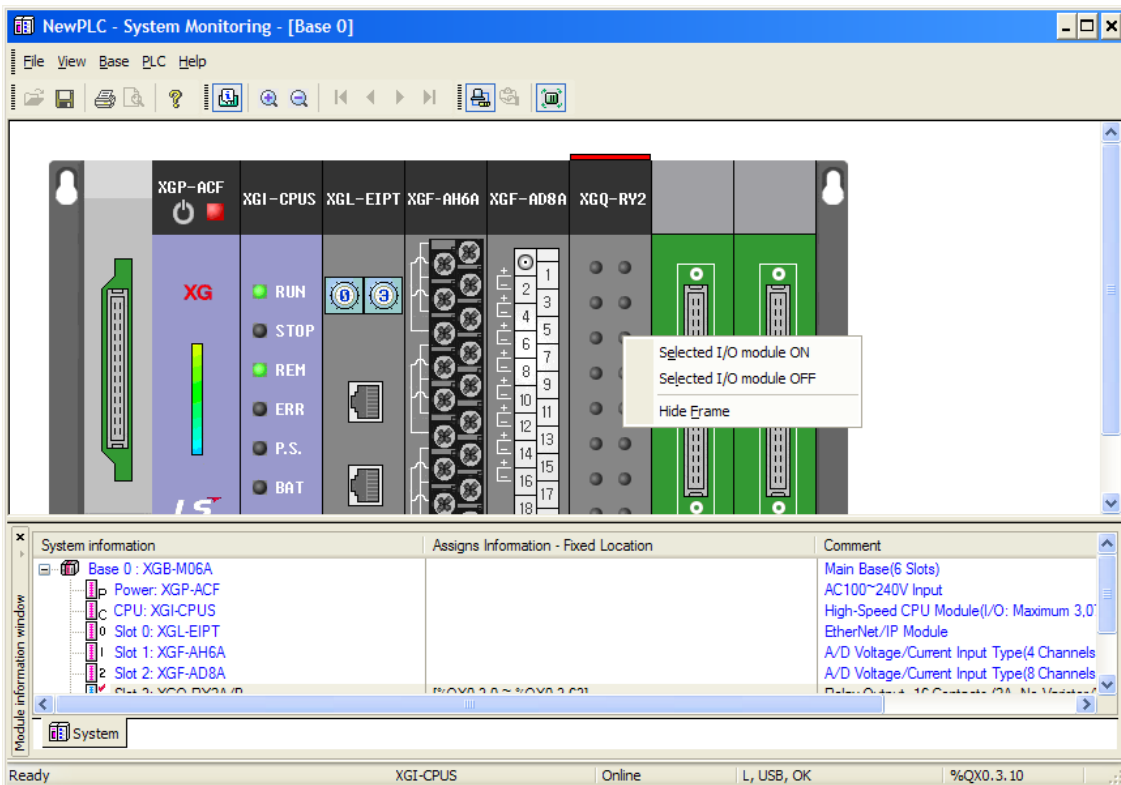

Select the module of system area and click the right button of mouse. Then select [Show Frame]

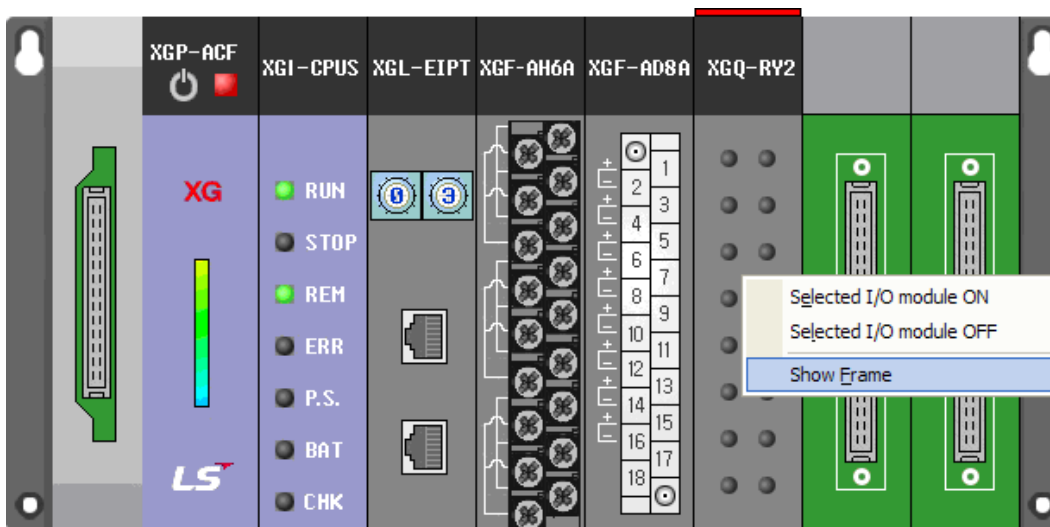



## 11.5 Device Monitoring

Device Monitoring can monitor all the device areas' data in PLC.

It can write or read data value on the PLC's specific device. In addition, Device Monitoring can display the data value variously when displayed or input on the screen according to bit format and display method.

### 11.5.1 Basic Application

[Steps]

There are 2 methods available to execute Device Monitoring function.

- a. Select [Monitor]-[Device Monitoring] on the XG5000 menu.
- b. Select [Program]-[XG5000]-[Device Monitoring] on the Start menu.

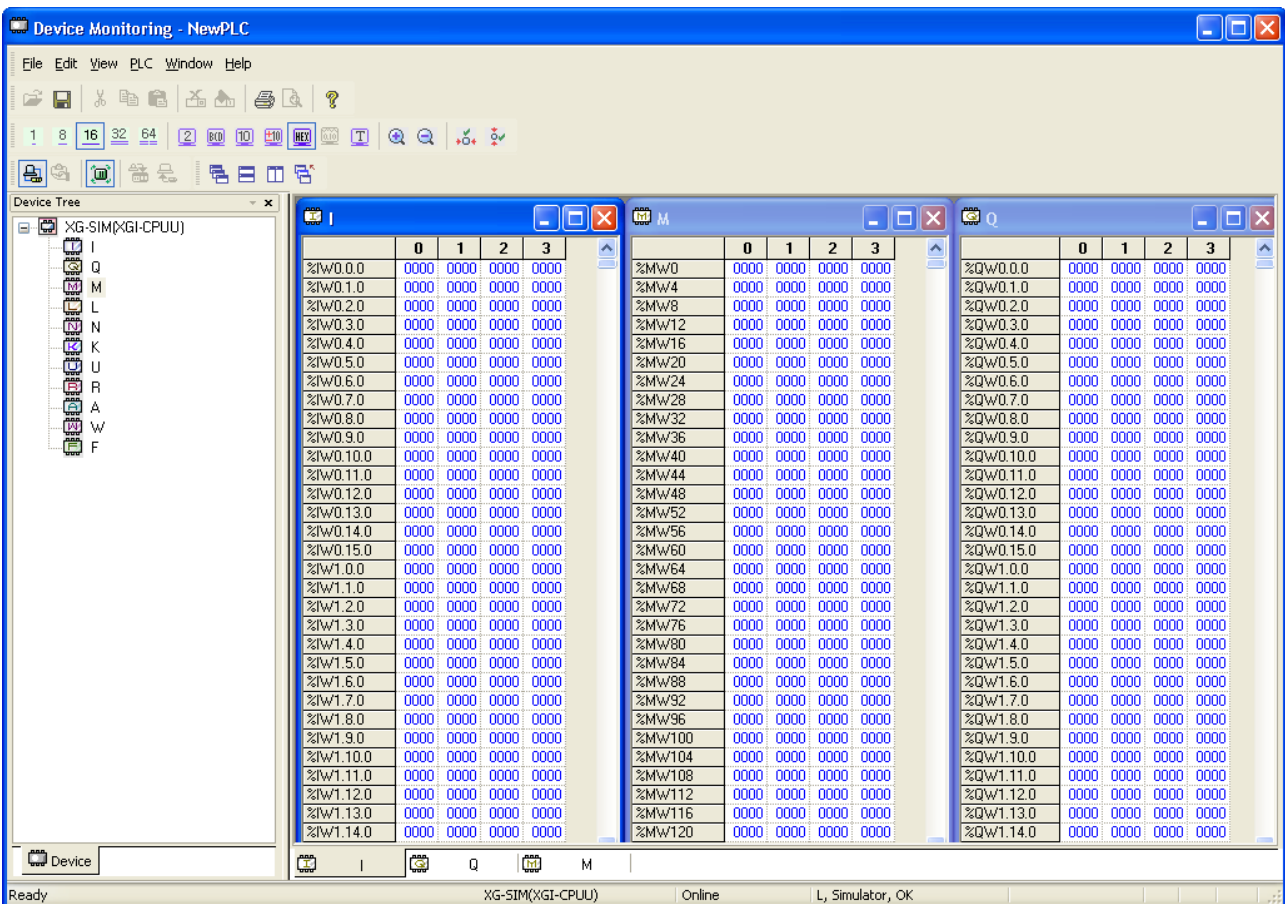

The device information window displays all the device areas in PLC, based on CPU type.

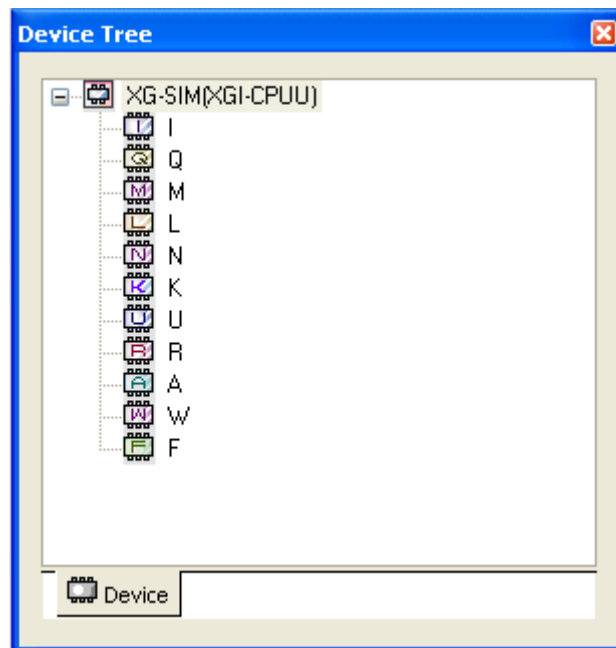

How to open the device is as follows. Double-click the device icon (Ex. I, Q, M, R, W) or click the right button of the mouse to select [Open Device] on the menu.

### Notes

- Device monitoring if executed on the XG5000 menu will be in Connect, Monitor status.
- If not in Monitoring mode, the device if open will display the previous data value.
- Basically the data value will be initialized to 0.

### 11.5.2 Device Areas

Device Areas are necessary for effective and correct control of various types of data. PLC provides various device areas of data to manage such data effectively. The user is requested to classify the data areas for applicable reference in the program.

Refer to XGI-CPUU manual for respective detailed device area.

## Chapter 11 Monitoring

### 11.5.3 Data Format and Display Items

There are mainly 4 methods to display data on the screen.

Display Setting	Description
Data Size	1 bit, 8 bits, 16 bits, 32 bits and 64 bits
Display Format	Binary, BCD, Unsigned decimal, Signed decimal, Hexadecimal, Real, String

#### 1) 1 bit

Data size of the device is displayed in 1 bit.

[Steps]

Select [View]-[View Options]-[1 bit] on the menu.

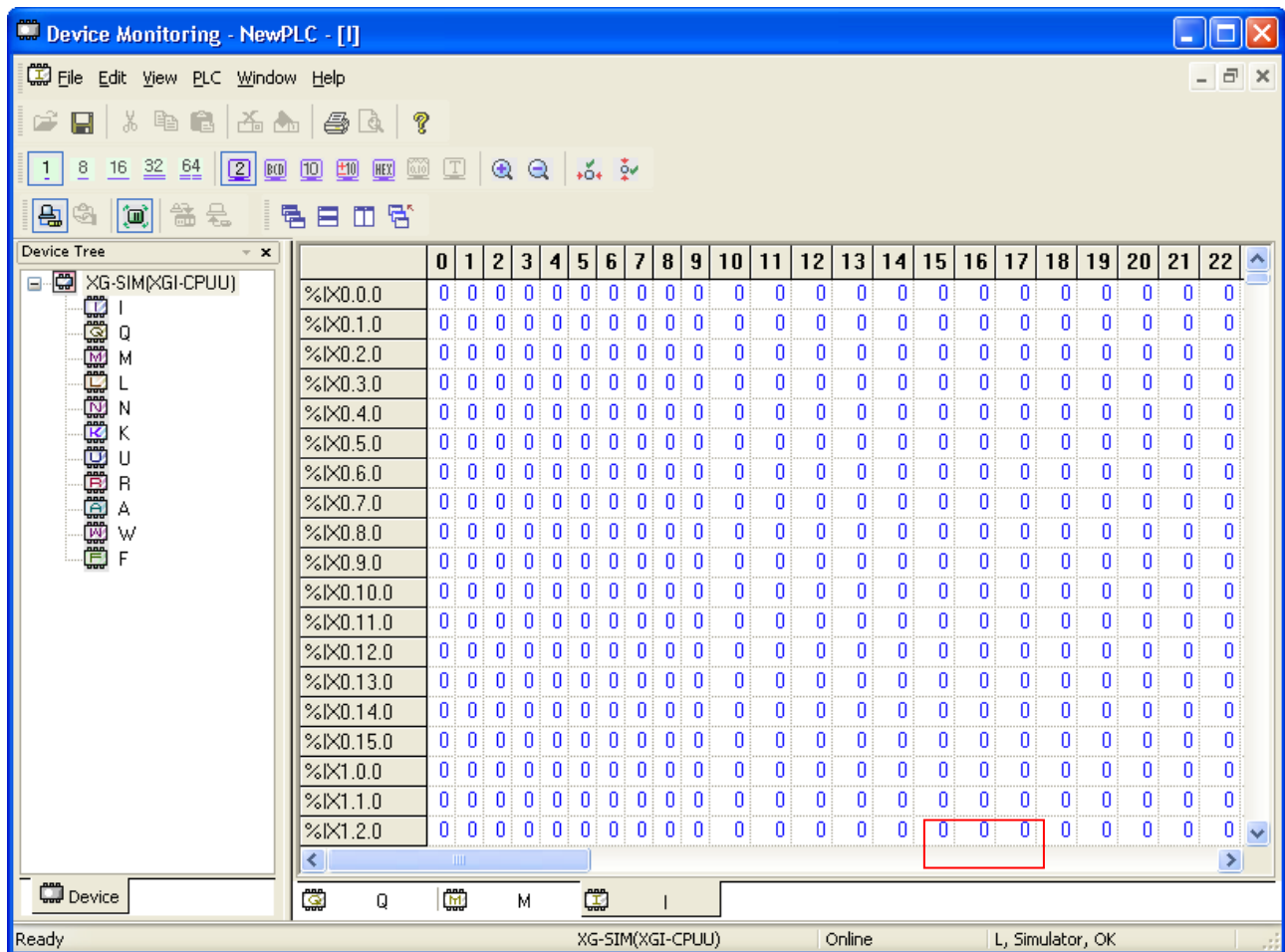

Notes

- a. The device of a selected cell is displayed in the progression bar.

2) 8 bits

Data size of the device is displayed in 8 bits.

[Steps]

1. Select [View]-[View Options]-[8 bits] on the menu.

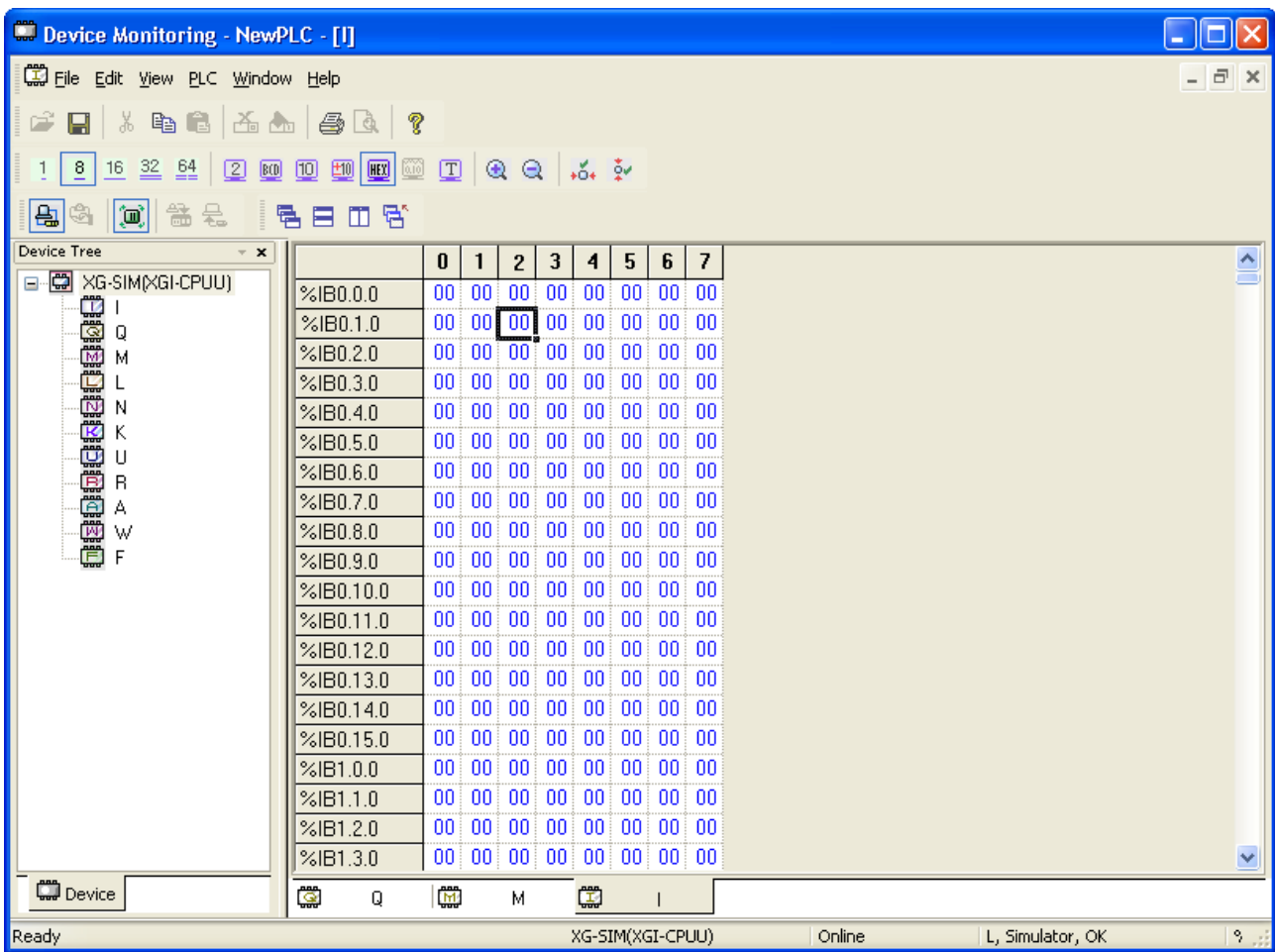

## Chapter 11 Monitoring

### 3) 16 bits

Data size of the device is displayed in 16 bits.

[Steps]

1. Select [View]-[View Options]-[16 bits] on the menu.

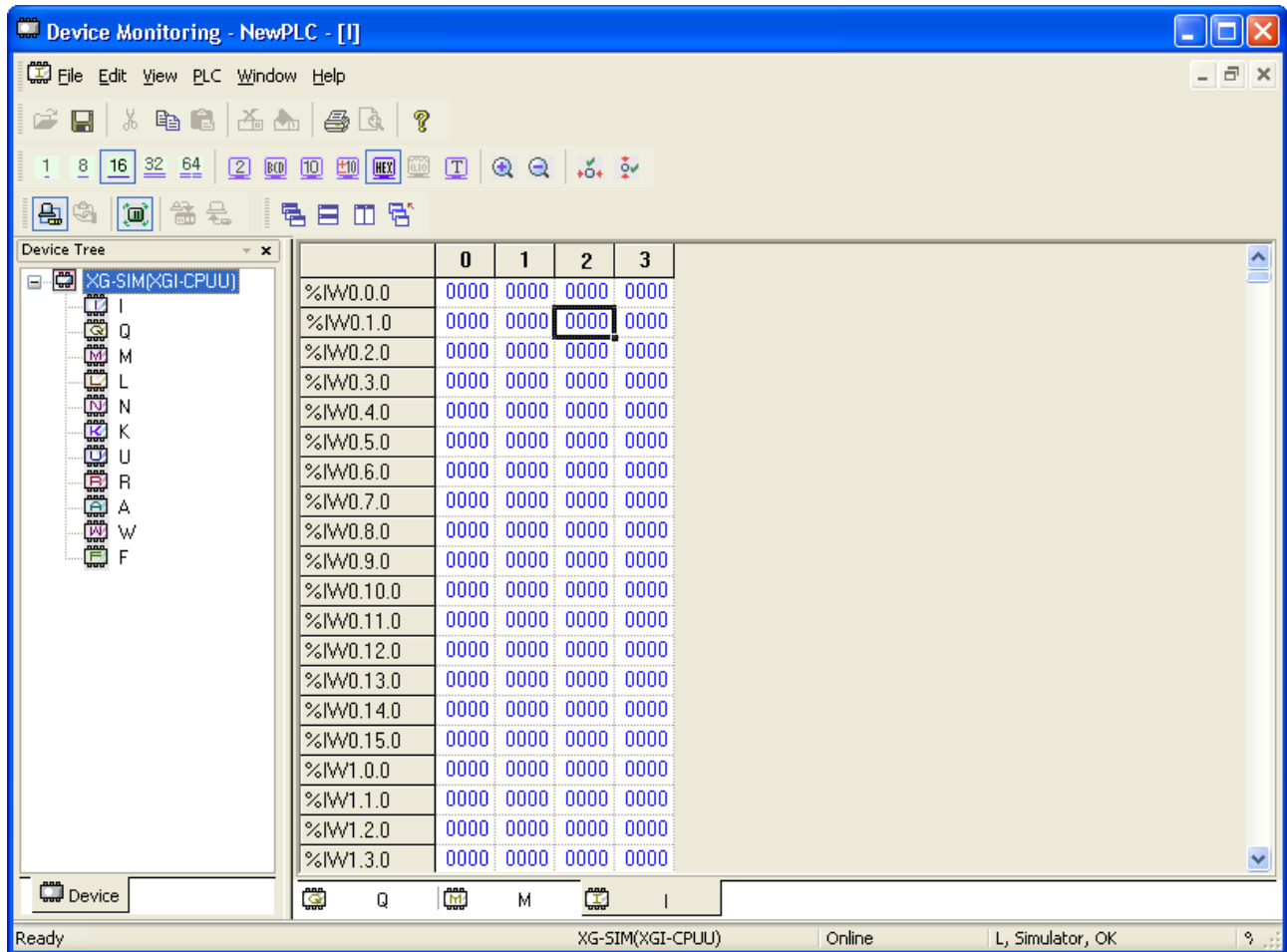

The screenshot shows the 'Device Monitoring - NewPLC - [I]' window. The interface includes a menu bar (File, Edit, View, PLC, Window, Help), a toolbar with various icons, and a 'Device Tree' on the left. The main area displays a table of data for the device 'XG-SIM(XGI-CPUU)'. The table has columns for bit addresses (0, 1, 2, 3) and rows for input/output addresses (%IW0.0.0 to %IW1.3.0). The data in the table is as follows:

	0	1	2	3
%IW0.0.0	0000	0000	0000	0000
%IW0.1.0	0000	0000	0000	0000
%IW0.2.0	0000	0000	0000	0000
%IW0.3.0	0000	0000	0000	0000
%IW0.4.0	0000	0000	0000	0000
%IW0.5.0	0000	0000	0000	0000
%IW0.6.0	0000	0000	0000	0000
%IW0.7.0	0000	0000	0000	0000
%IW0.8.0	0000	0000	0000	0000
%IW0.9.0	0000	0000	0000	0000
%IW0.10.0	0000	0000	0000	0000
%IW0.11.0	0000	0000	0000	0000
%IW0.12.0	0000	0000	0000	0000
%IW0.13.0	0000	0000	0000	0000
%IW0.14.0	0000	0000	0000	0000
%IW0.15.0	0000	0000	0000	0000
%IW1.0.0	0000	0000	0000	0000
%IW1.1.0	0000	0000	0000	0000
%IW1.2.0	0000	0000	0000	0000
%IW1.3.0	0000	0000	0000	0000

The status bar at the bottom shows 'Ready', 'XG-SIM(XGI-CPUU)', 'Online', and 'L, Simulator, OK'.

4) 32 bits

Data size of the device is displayed in 32 bits.

[Steps]

1. Select [View]-[View Options]-[32 bit] on the menu

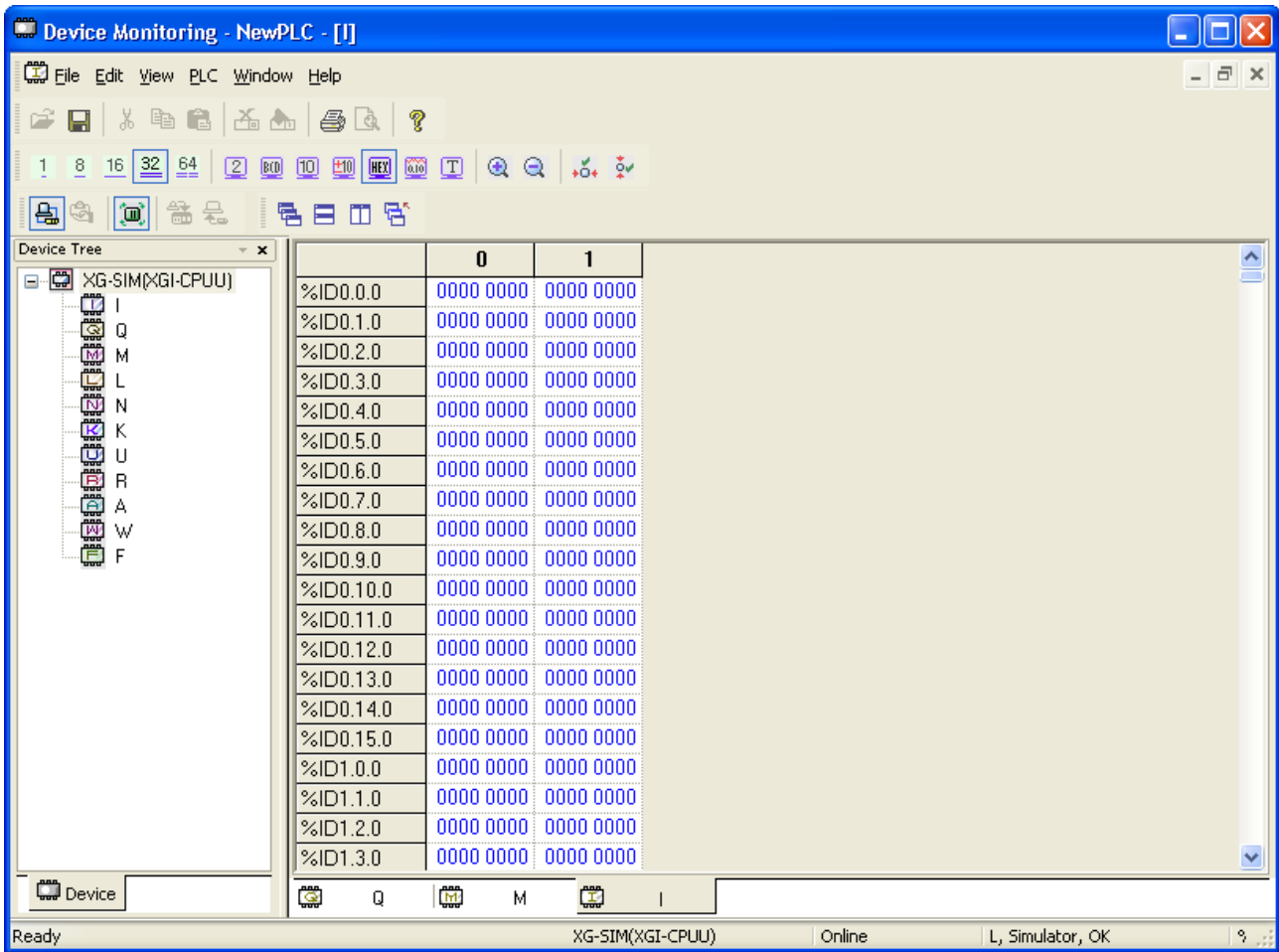

## Chapter 11 Monitoring

5) 64 bits

Data size of the device is displayed in 64 bits.

[Steps]

1. Select [View]-[View Options]-[64 bit] on the menu.

The screenshot shows the 'Device Monitoring' window for a new PLC. The 'Device Tree' on the left lists the following components: I, Q, M, L, N, K, U, R, A, W, and F. The main display area shows a table of input bits (IL) with their addresses and values. The values are all '0000 0000 0000 0000'. The status bar at the bottom shows 'Ready', 'XG-SIM(XGI-CPUU)', 'Online', and 'L, Simulator, OK'.

Address	Value
%IL0.0.0	0000 0000 0000 0000
%IL0.1.0	0000 0000 0000 0000
%IL0.2.0	0000 0000 0000 0000
%IL0.3.0	0000 0000 0000 0000
%IL0.4.0	0000 0000 0000 0000
%IL0.5.0	0000 0000 0000 0000
%IL0.6.0	0000 0000 0000 0000
%IL0.7.0	0000 0000 0000 0000
%IL0.8.0	0000 0000 0000 0000
%IL0.9.0	0000 0000 0000 0000
%IL0.10.0	0000 0000 0000 0000
%IL0.11.0	0000 0000 0000 0000
%IL0.12.0	0000 0000 0000 0000
%IL0.13.0	0000 0000 0000 0000
%IL0.14.0	0000 0000 0000 0000
%IL0.15.0	0000 0000 0000 0000
%IL1.0.0	0000 0000 0000 0000
%IL1.1.0	0000 0000 0000 0000
%IL1.2.0	0000 0000 0000 0000
%IL1.3.0	0000 0000 0000 0000

6) Binary

Data is displayed in binary.

[Steps]

1. Select [View]-[View Options]-[Binary] on the menu.

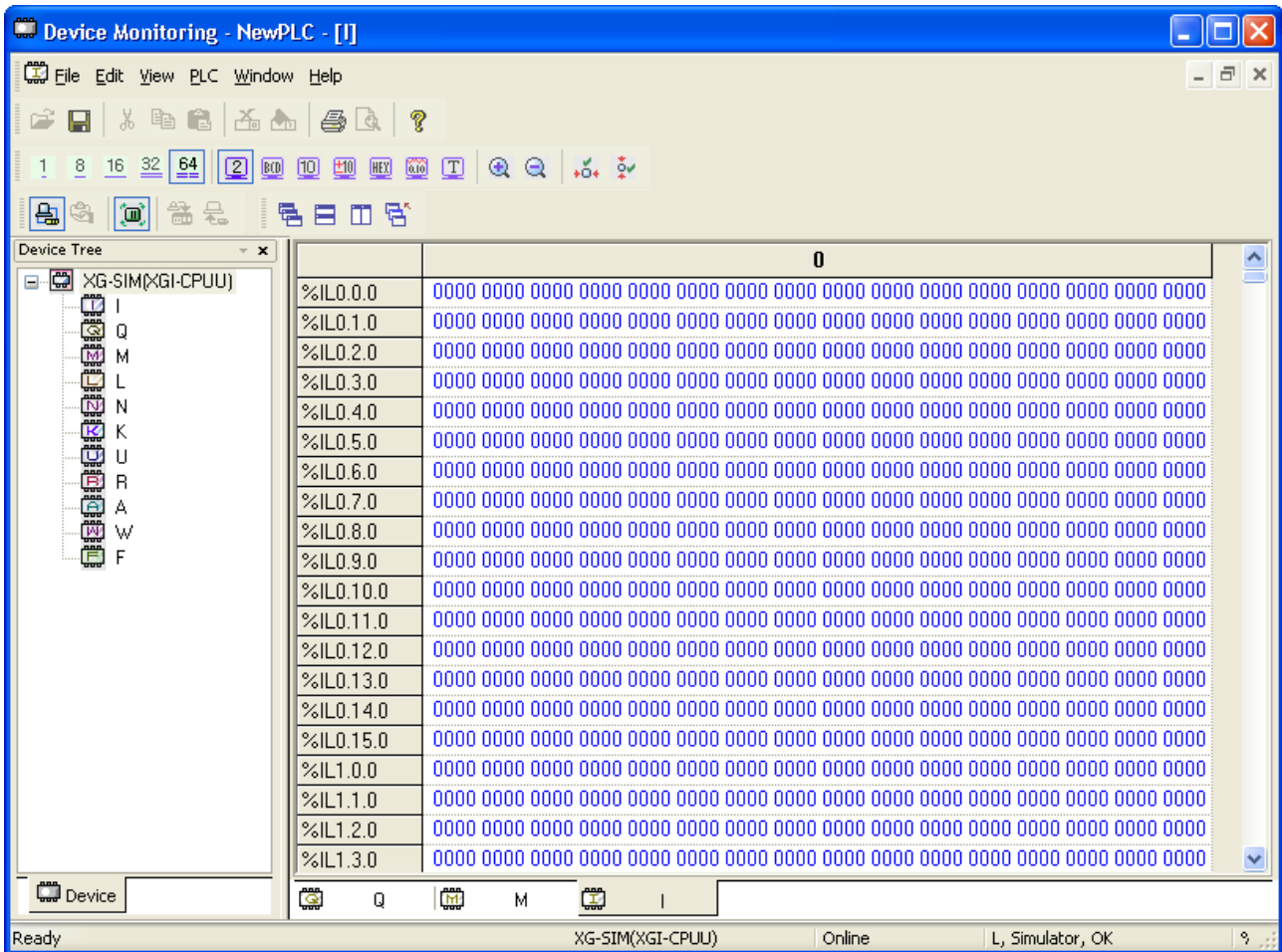

[Detailed Description]

- a. Data value is displayed by 1 and 0.

Application Example)

Hexadecimal	1234
Binary	0001 0010 0011 0100



## Chapter 11 Monitoring

### 7) BCD

Data is displayed in BCD.

[Steps]

1. Select [View]-[View Options]-[BCD] on the menu.

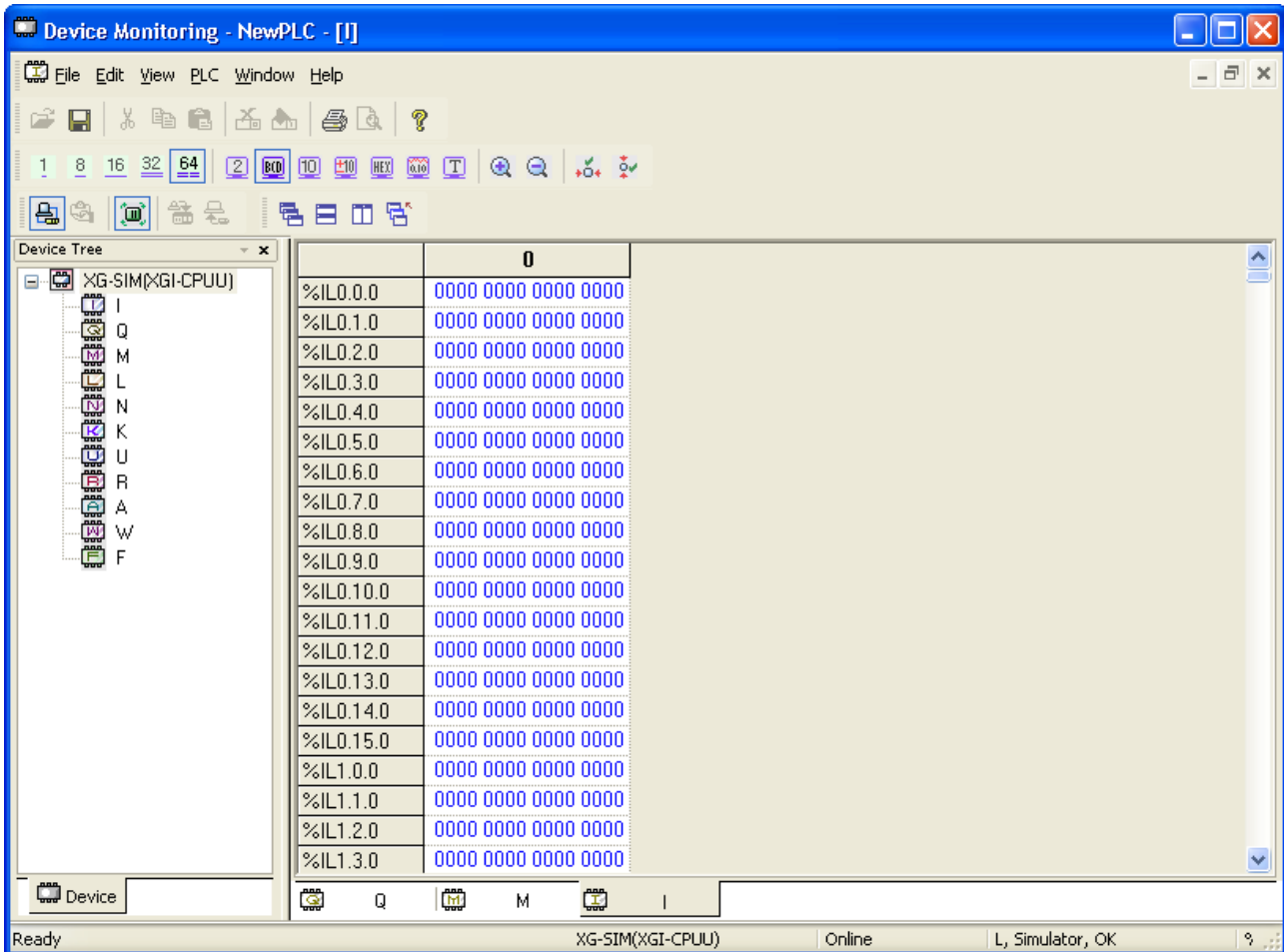

[Detailed Description]

- a. Data value is displayed by the figures of 0 ~ 9.

Application Example)

Hexadecimal	1234
BCD	1234

8) Unsigned decimal

Data is displayed in unsigned decimal.

[Steps]

1. Select [View]-[View Options]-[Unsigned Decimal] on the menu.

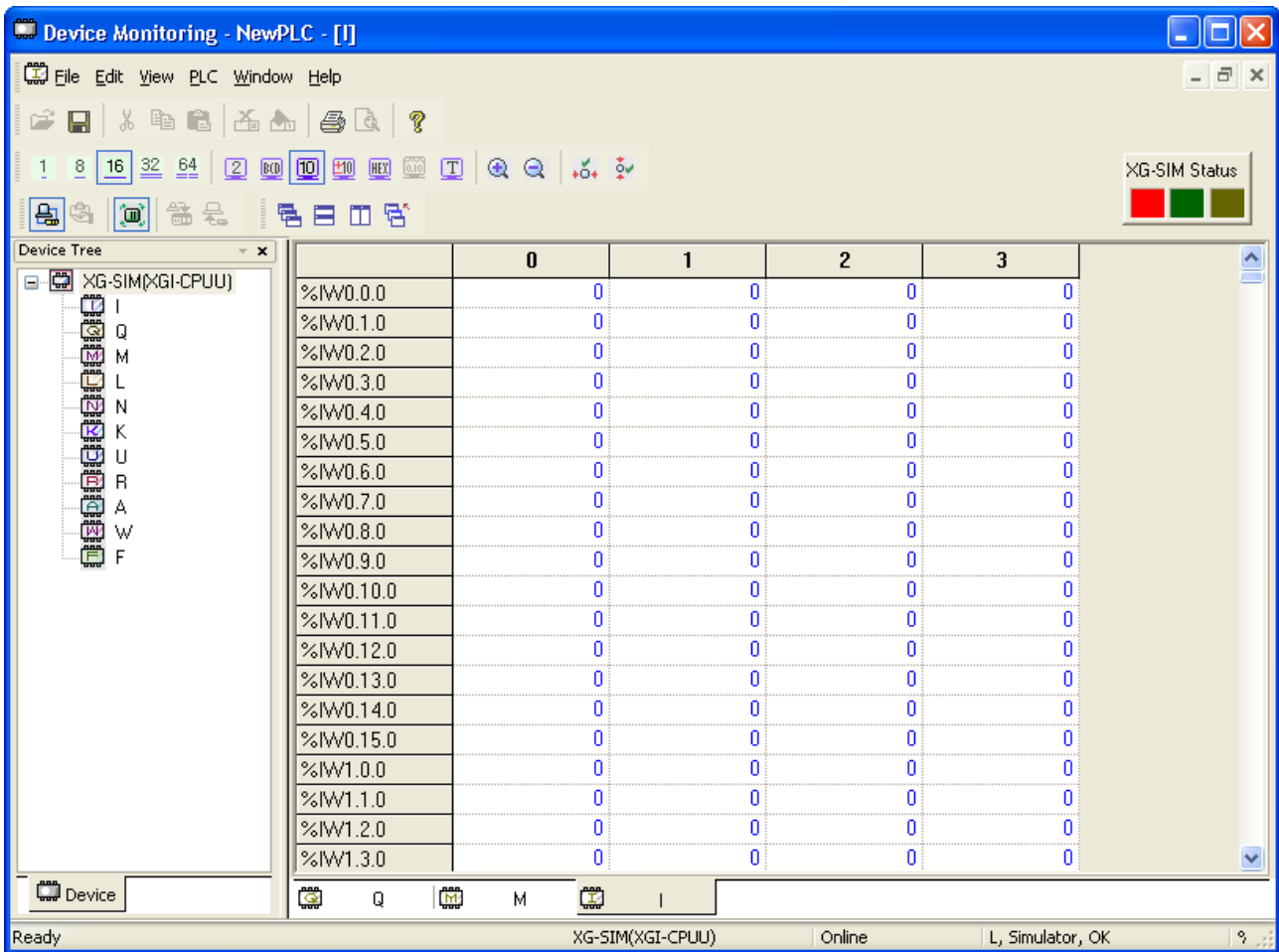

[Detailed Description]

- Data value is displayed by the figures of 0 ~ 9.

Application Example)

Hexadecimal	1234
Unsigned decimal	4660

## Chapter 11 Monitoring

### 9) Signed Decimal

Data is displayed in signed decimal.

[Steps]

1. Select [View]-[View Options]-[Signed Decimal] on the menu.

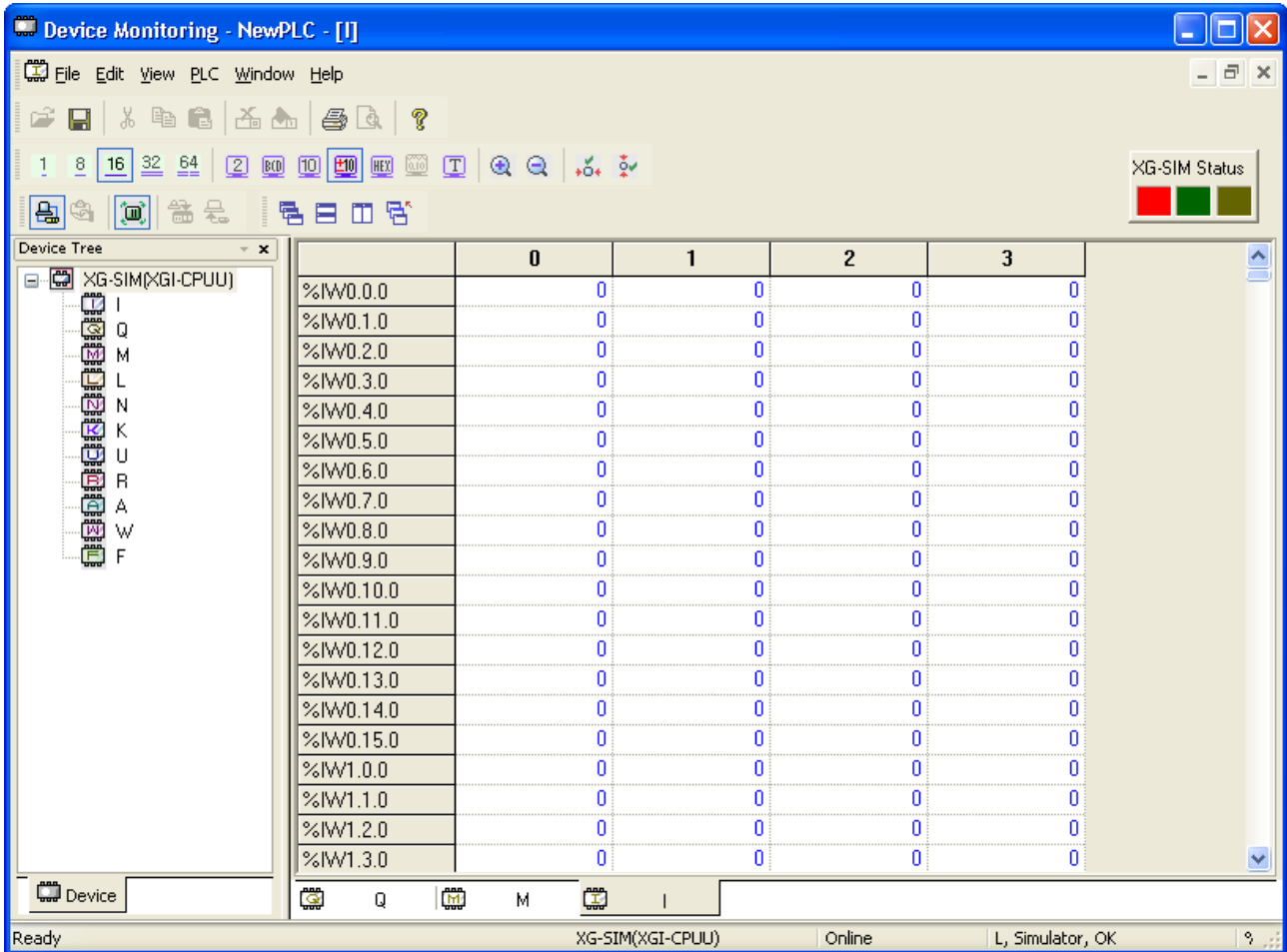

[Detailed Description]

- a. Data value is displayed by the figures of 0 ~ 9.

Application Example)

Hexadecimal	1234
Signed decimal	4660

### 10) Hexadecimal

Data is displayed in hexadecimal.

[Steps]

Select [View]-[View Options]-[Hexadecimal] on the menu.

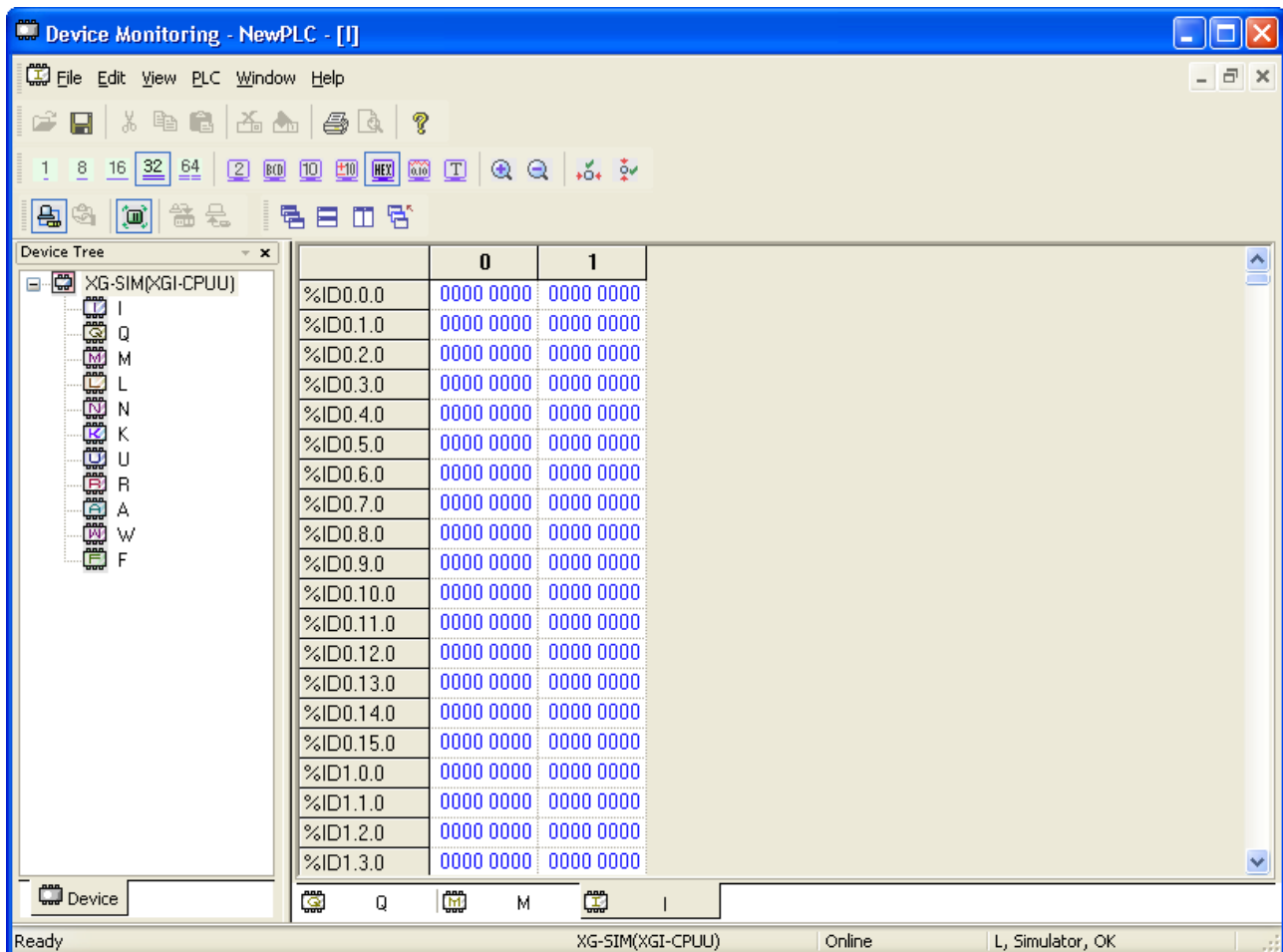

11) Real

Data is displayed in real.

[Steps]

Select [View]-[View Options]-[Real] on the menu.

## Chapter 11 Monitoring

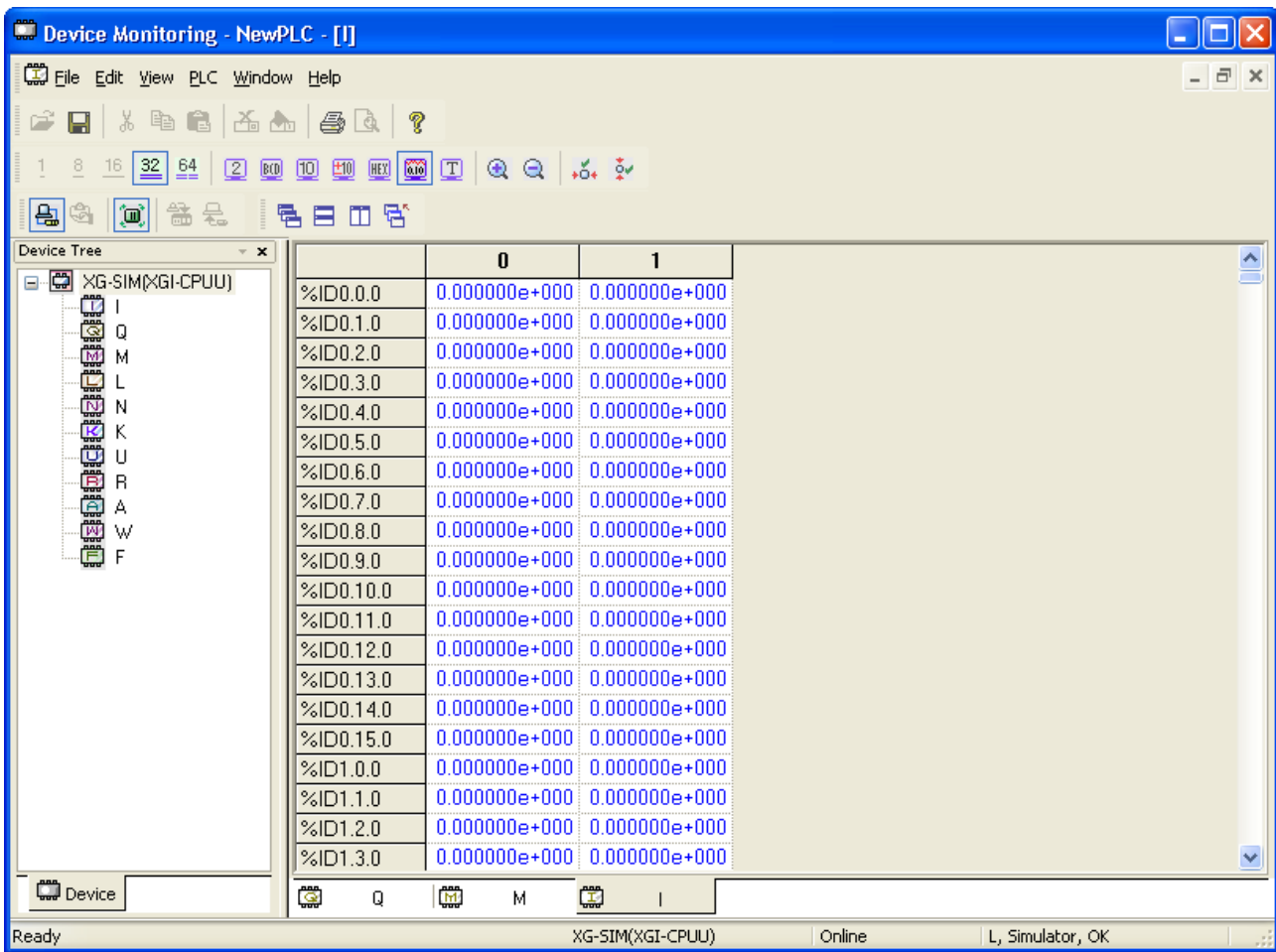

[Detailed Description]

- a. Data value is displayed in real.
- b. Real format is available in 32 bits and 64 bits.

Application Example)

Hexadecimal	5678 1234
Real	6.818927e+013

### 12) Text

Data is displayed in ASCII string.

[Steps]

1. Select [View]-[View Options]-[Text] on the menu.

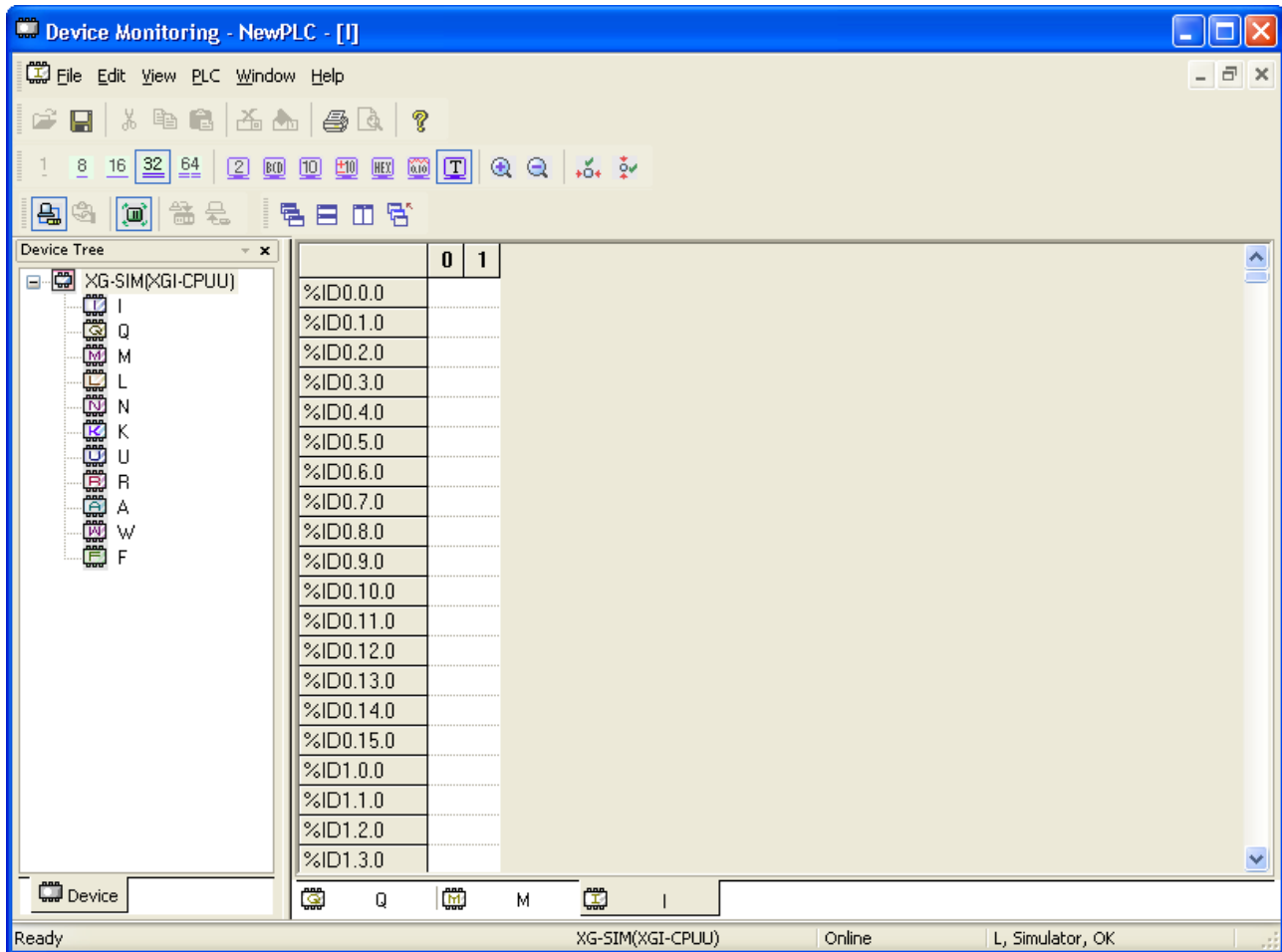

[Detailed Description]

a. Data value is displayed in ASCII string.

Application Example)

Hexadecimal	1234
Text	4↓

### 11.5.4 Edit Data

Data value shall be specified to write device data on PLC, or to write the selected area only on PLC.

#### 1) Edit Cell

It is used to edit data on the cell.

## Chapter 11 Monitoring

---

[Steps]

1. Use the mouse or keyboard to select an optional cell.
2. Input data into the selected cell.

### 2) Cut

It is used to delete the data of the selected area to save it in the clipboard.

[Steps]

1. Select the area to cut.
2. Select [Edit]-[Cut] on the menu.

### 3) Copy

It is used to copy the data of the selected area to save it in the clipboard.

[Steps]

- Select the area to copy.
- Select [Edit]-[Copy] on the menu.

### 4) Delete

It is used to delete the data of the selected area.

[Steps]

1. Select the area to delete.
2. Select [Edit]-[Delete] on the menu.

### 5) Paste

It is used to paste the data saved in the clipboard on a selected location.

[Steps]

1. Select the area to paste.
2. Select [Edit]-[Paste] on the menu.

### 6) Fill

It is used to fill the selected data.

[Steps]

1. Use the mouse to select the cell area to fill automatically.
2. Position the mouse at the end of the cell to make the mouse cursor shaped "+".
3. Move the mouse with its left button pressed up/down and right/left.
4. Release the left button of the mouse.

### 11.5.5 Save Device

There are 3 methods available to save the device.

#### 1) Save All Device Areas

[Steps]

1. Select [File]-[Save] on the menu.
2. Select [File]-[Save As] on the menu to save the data as a different name.
  - a. File extension will be set as (.mem).

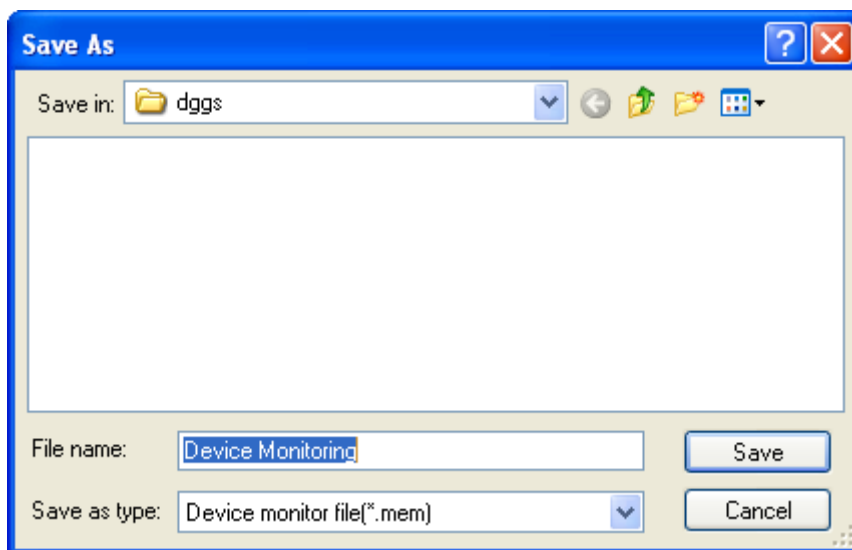

#### 2) Save Respective Device Area

[Steps]

1. Select [File]-[Export Device to File] on the menu.
  - a. File extension will be set as (device+m). (Ex. iim, iqm, imm,...)



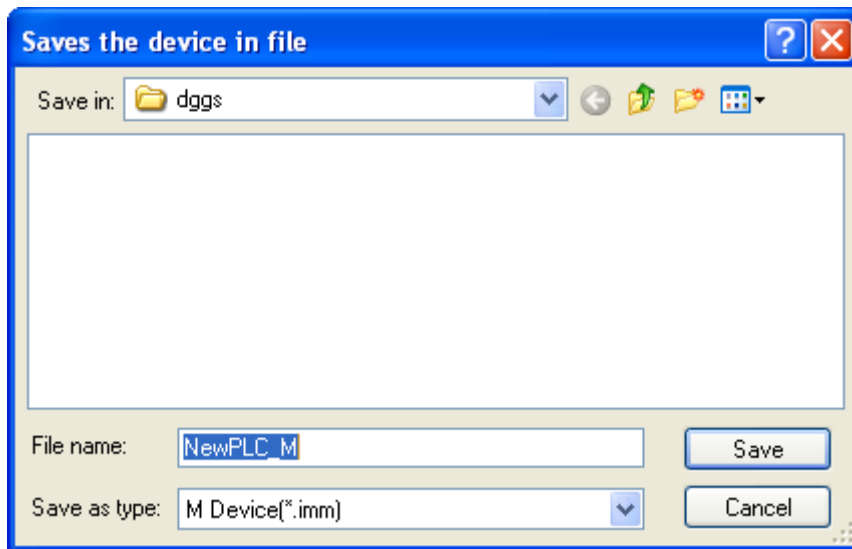

### 3) Save Respective Device Area if all windows closed

[Steps]

1. Select [File]-[ Export Device to File] on the menu.
2. Select the device to save from the combo box.
  - a. File extension will be set as (i+device+m). (Ex. iim, iqm, imm,...)

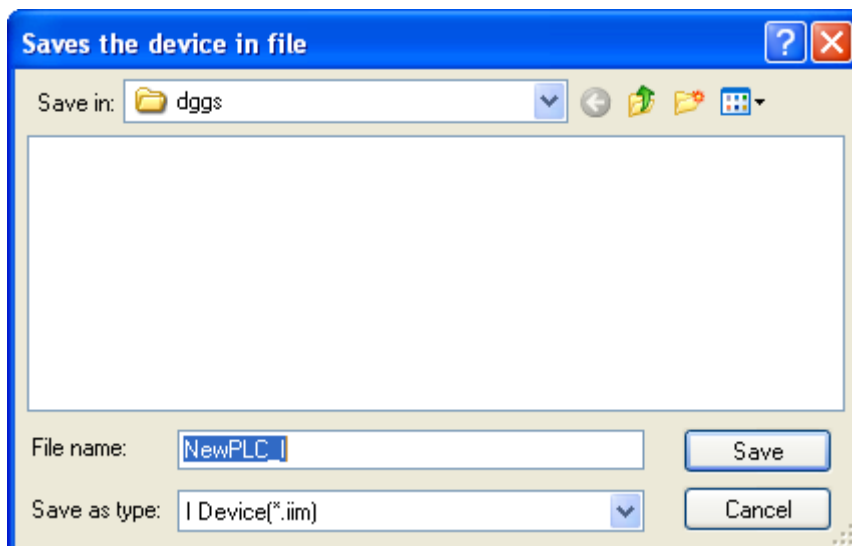

### 11.5.6 Open Device

There are 3 methods available to open the device.

#### 1) Open All Device Areas

[Steps]

1. Select [File]-[Open] on the menu.

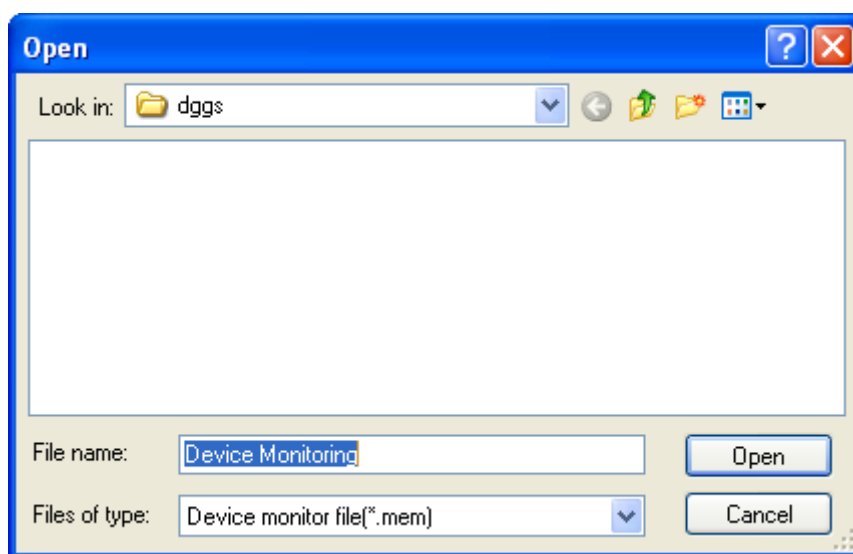

#### 2) Import Device from File

[Steps]

1. Select [File]-[Import Device from File] on the menu.

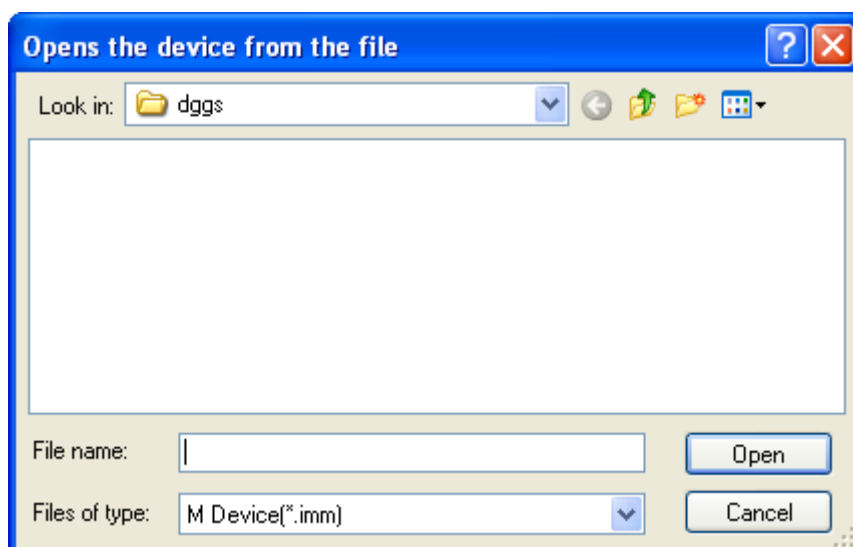

## Chapter 11 Monitoring

3) Open Respective Device Area if all windows closed

[Steps]

1. Select [File]-[Import Device from File] on the menu.
2. Select the device to open from the combo box.

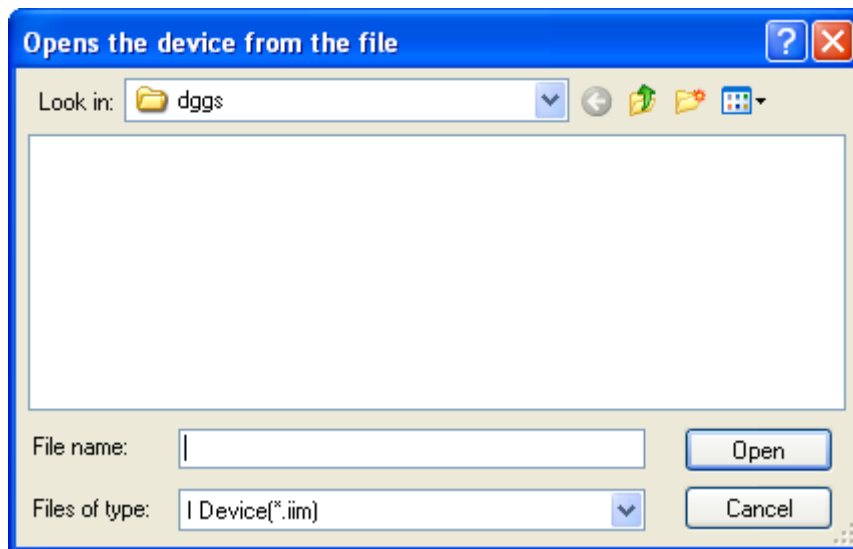

### Notes

- a. If in monitoring mode, Open and Open Device from File are inactive.

### 11.5.7 Data Value Setting

Data value of the device can be specified according to its display type and the number of bits. In addition, setting area of the data value can be selected.

[Steps]

1. Select [Edit]-[Fill Data Area] on the menu.

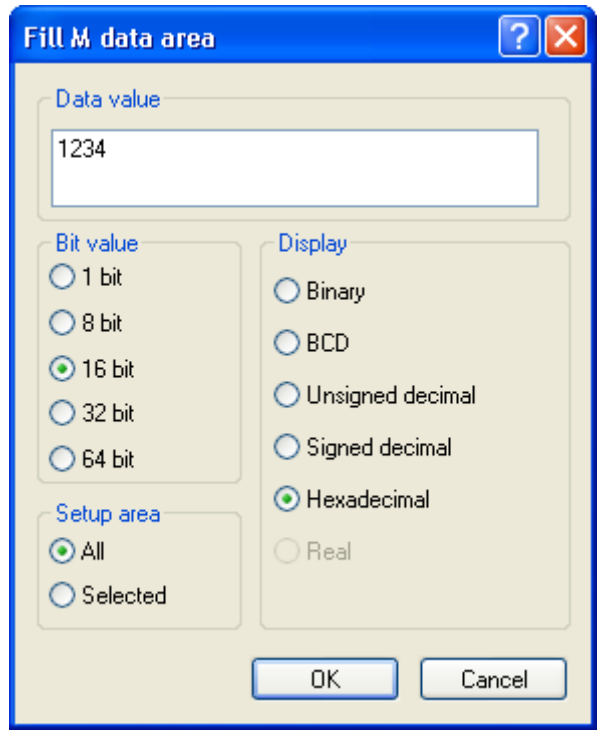
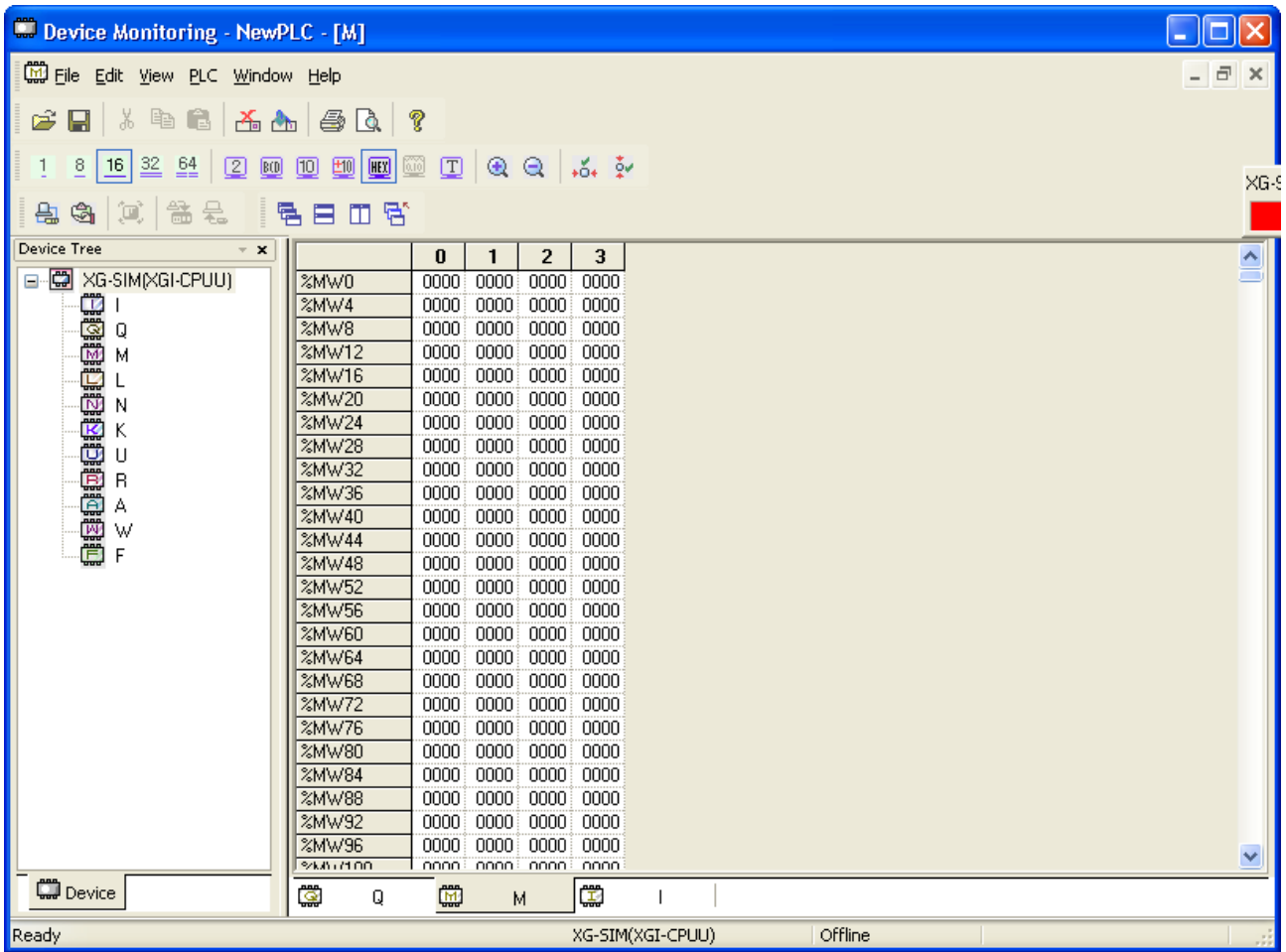

# Chapter 11 Monitoring

The screenshot shows the 'Device Monitoring' software interface. The main window title is 'Device Monitoring - NewPLC - [M]'. The menu bar includes 'File', 'Edit', 'View', 'PLC', 'Window', and 'Help'. The toolbar contains various icons for file operations and monitoring. Below the toolbar is a row of numeric and format buttons (1, 8, 16, 32, 64, 2, BCD, 10, HEX, 0.10, T). The 'Device Tree' on the left shows a hierarchy starting with 'XG-SIM(XGI-CPUU)', followed by components I, Q, M, L, N, K, U, R, A, W, and F. The main display area is a table showing memory addresses and their values:

	0	1	2	3
%MW0	1234	1234	1234	1234
%MW4	1234	1234	1234	1234
%MW8	1234	1234	1234	1234
%MW12	1234	1234	1234	1234
%MW16	1234	1234	1234	1234
%MW20	1234	1234	1234	1234
%MW24	1234	1234	1234	1234
%MW28	1234	1234	1234	1234
%MW32	1234	1234	1234	1234
%MW36	1234	1234	1234	1234
%MW40	1234	1234	1234	1234
%MW44	1234	1234	1234	1234
%MW48	1234	1234	1234	1234
%MW52	1234	1234	1234	1234
%MW56	1234	1234	1234	1234
%MW60	1234	1234	1234	1234
%MW64	1234	1234	1234	1234
%MW68	1234	1234	1234	1234
%MW72	1234	1234	1234	1234
%MW76	1234	1234	1234	1234
%MW80	1234	1234	1234	1234
%MW84	1234	1234	1234	1234
%MW88	1234	1234	1234	1234
%MW92	1234	1234	1234	1234
%MW96	1234	1234	1234	1234
%MW100	1234	1234	1234	1234

The status bar at the bottom shows 'Ready', 'XG-SIM(XGI-CPUU)', and 'Offline'. There are also buttons for 'Device', 'Q', 'M', and 'I'.

[Dialog Box]

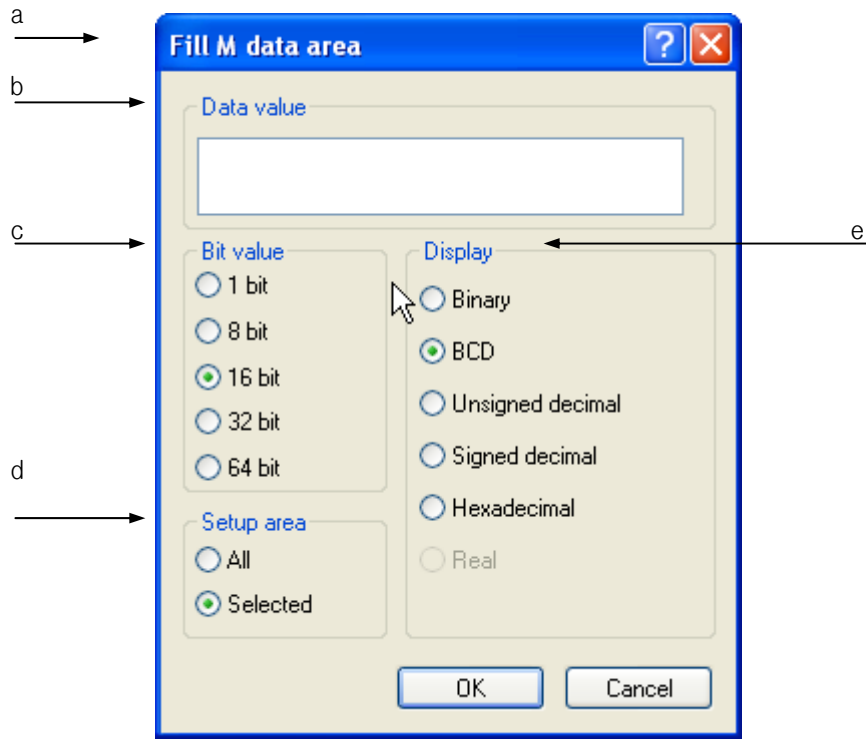

[Description of Dialog Box]

- a. Title bar: used to display the device to set its data value.
- b. Data value: used to input and display the data compatible with the number of bits and the display format.
- c. Bit value: used to decide the size of data.
- d. Setup area: used to decide the range the data value is applied to in the device.
- e. Display: used to decide the input format of data and change the format of the data value according to changed value display if any data value is available.

#### Notes

- a. Device name is displayed on the title to call dialog box of Setting Data Value.

## Chapter 11 Monitoring

### 11.5.8 Clear Data

It is used to delete all data value of the device.

[Steps]

1. Select [Edit]-[Clear Data] on the menu.
2. A message will be called to ask if you want to delete the whole device areas.

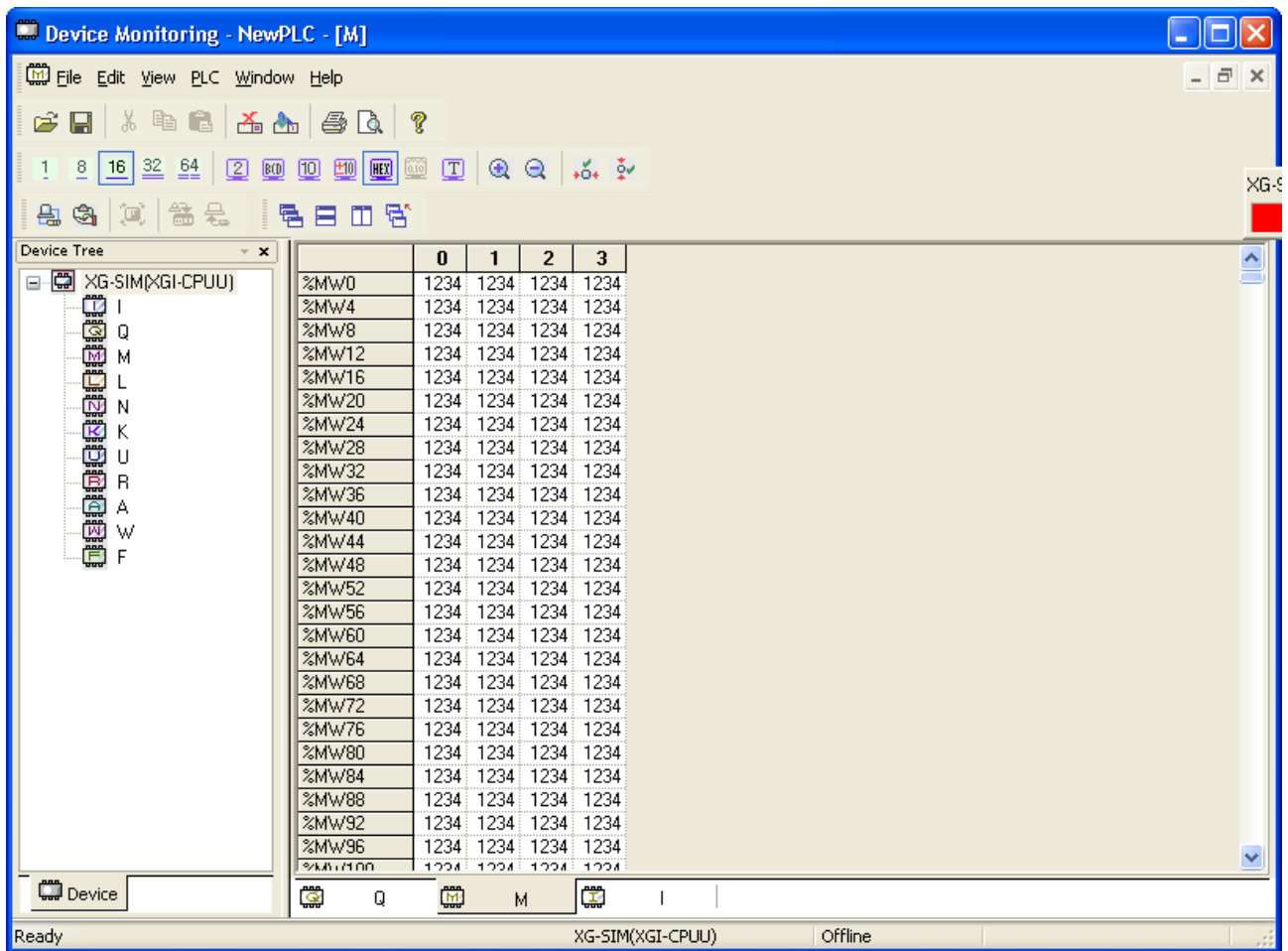

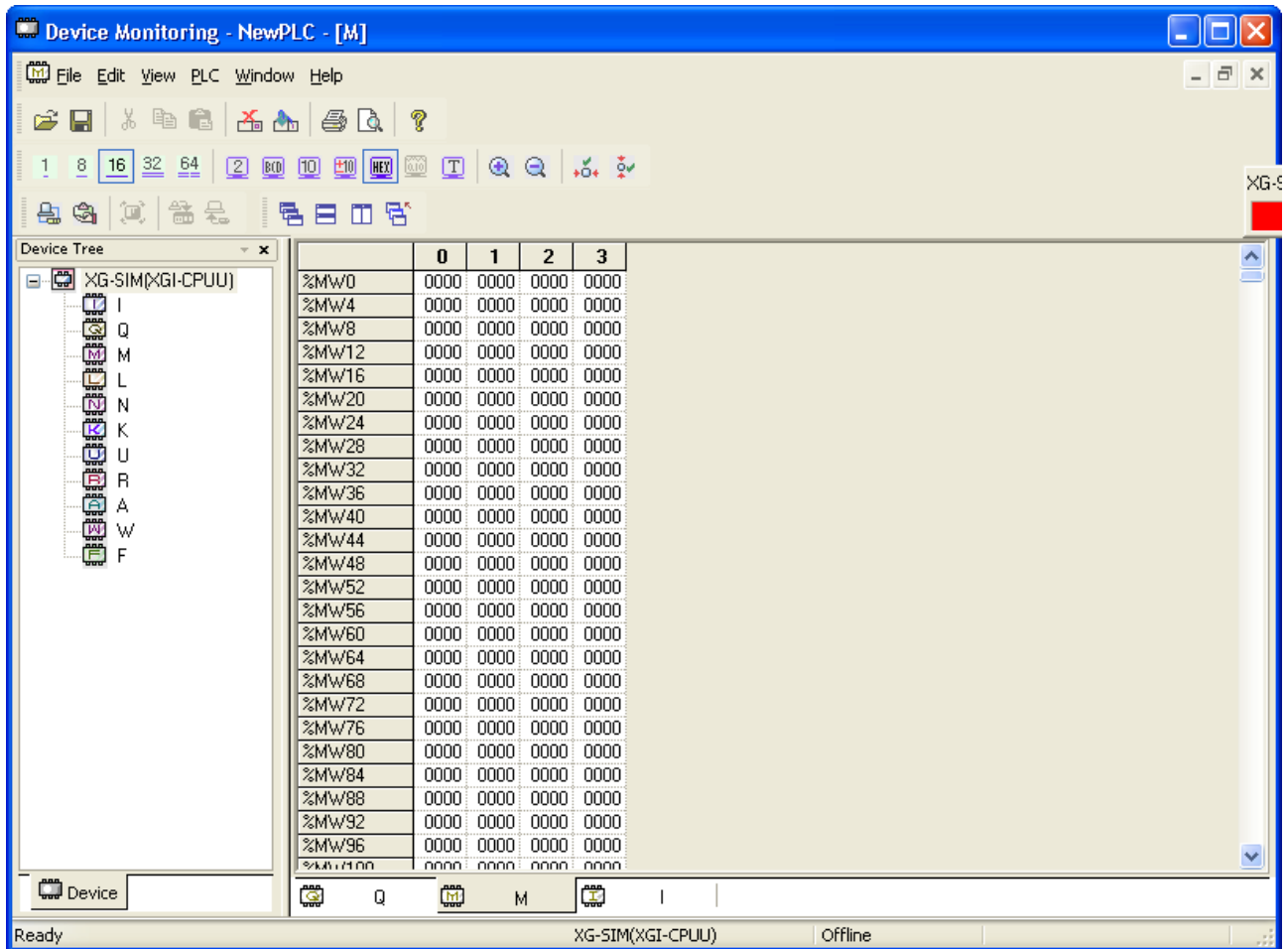

### 11.5.9 Write to PLC

It is used to transfer the device data saved in on-line computer to PLC.

[Steps]

1. Ensure PLC is connected and the monitoring mode is inactive.
2. Select [PLC]-[Write to PLC] on the menu.
3. Select the device to write on Write dialog box of PLC.
4. Click OK to write the selected device on PLC.



## Chapter 11 Monitoring

[Dialog Box]

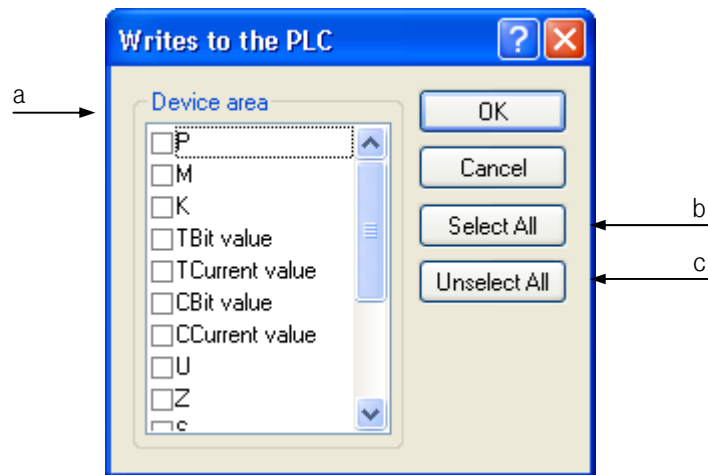

[Description of Dialog Box]

- a. Device Area: used to display the list of the devices to write on PLC.
- b. Select All: used to select all the devices in the device area.
- c. Unselect All: used to cancel all the devices selected in the device area.

### Notes

- a. F device's exclusive Read areas can not be written on PLC. Exclusive Read areas are based on the type of CPU.

### 11.5.10 Read from PLC

It is used to read the device data saved in PLC to on-line computer.

[Steps]

1. Ensure PLC is connected and the monitoring mode is inactive.
2. Select [PLC]-[Read from PLC] on the menu.
3. Select the device to read from Read dialog box of PLC.
4. Click OK to read the selected device from PLC.

[Dialog Box]

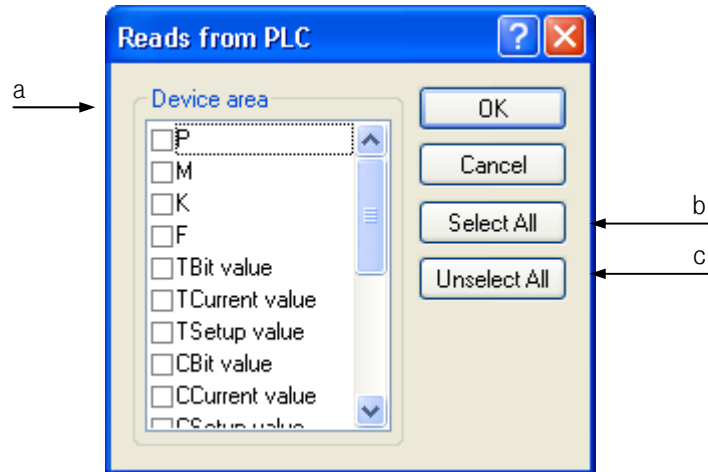

[Description of Dialog Box]

- a. Device Area: used to display the list of the devices to read from PLC.
- b. Select All: used to select all the devices in the device area.
- c. Unselect All: used to cancel all the devices selected in the device area.

### 11.5.11 Write Selected Area on PLC

It is used to write the device data in the selected area on PLC connected.

[Steps]

1. Select the area to write on PLC.
2. Select [PLC]-[Write Selected Area to PLC] on the menu.
3. A message will be called to ask if you want to write the selected area on PLC.

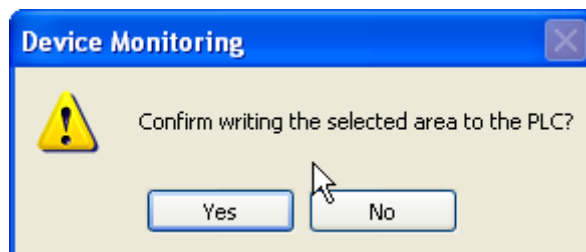

4. Write the selected area on PLC.

### 11.5.12 Start/Stop Monitoring

It reads the device data from PLC to display on the screen in the on-line status, or it stops reading the data.

#### 1) Start Monitoring

It reads the device data from PLC to display on the screen in the on-line status.

[Steps]

1. Confirm the connection status with PLC.
2. Select [PLC]-[Start Monitoring] on the menu.

#### 2) Stop Monitoring

It stops reading the device data from PLC in the on-line status.

[Steps]

1. Confirm the connection status with PLC.
2. Select [PLC]-[Stop Monitoring] on the menu.

#### Notes

- a. If in monitoring mode, the data can not be edited.
- b. If in monitoring mode, [Write to PLC], [Read from PLC], [Write Selected Area to PLC] are not available.

### 11.5.13 Change Current Value

It is used to change the data value of the cell in monitoring mode.

[Steps]

1. Ensure PLC is connected and the monitoring mode is active.
2. Select [PLC]-[Change Current Value] on the menu.
3. Dialog box of Change Current Value will be called.

[Dialog Box]

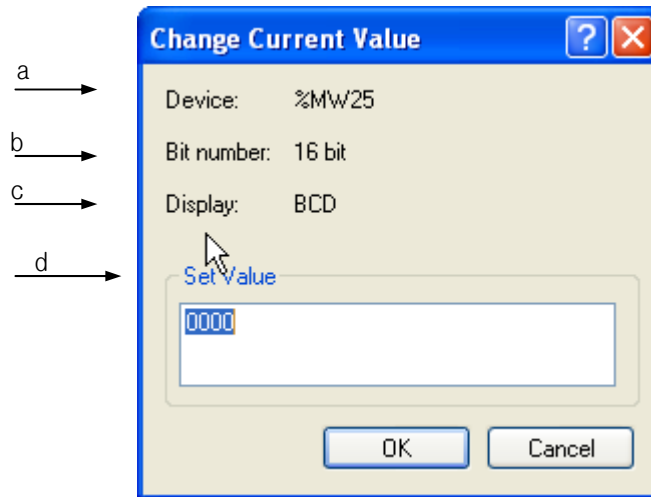

[Description of Dialog Box]

- a. Device: used to display the start device to change the current value.
- b. Bit number: used to display the number of bits to change the current value.
  - Usually it is identical to 1, 8, 16, 32 or 64 bits as displayed on the screen.
  - String format is displayed in 32\*8 bits.
- c. Display: used to display the data display format to change the current value.
- d. Set Value: used to display the data value to change the current value.

#### Notes

- a. If the current value is changed in string display format, the data value of 32-byte area is changed always from the start device.

### 11.5.14 PLC Type Settings

It is used to display the PLC type presently set or to set device data based on the PLC type.

[Steps]

1. Select [File]-[ PLC Type Settings] on the menu.

[Dialog Box]

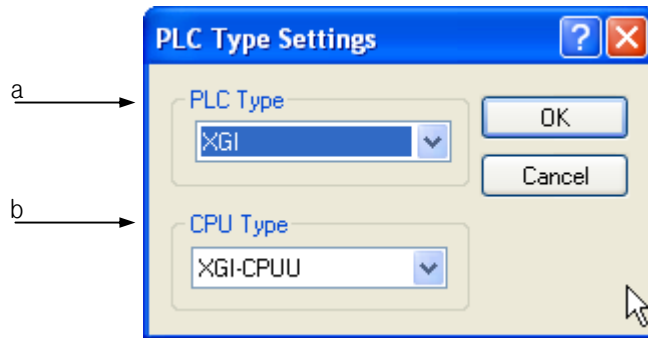

[Description of Dialog Box]

- a. PLC Type: used to display or change the PLC type presently set.
- b. CPU type: displays the presently set CPU type or changes the CPU type.

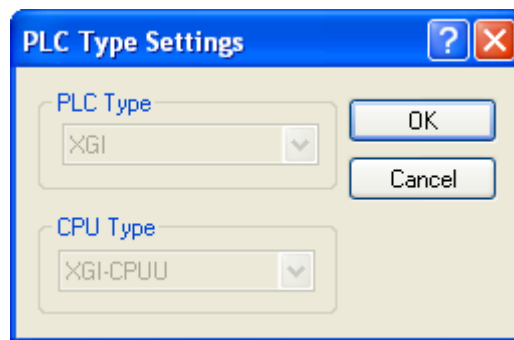

### Notes

- a. While connected with PLC, the present PLC type can be displayed only, not changeable.

### 11.5.15 Screen Zoom-In/Zoom-Out

It is used to zoom in or out the size of the screen displayed.

#### 1) Screen Zoom-In

It zooms in the screen.

[Steps]

1. Select [View]-[Zoom-In] on the menu.

### 2) Screen Zoom-Out

It zooms out the screen.

[Steps]

1. Select [View]-[Zoom-Out] on the menu.

### 11.5.16 Automatic Width/Height Adjustment

This function is used to adjust the size of the data values so to display on the screen.

#### 1) Width AutoFit

It adjusts the size to the string length of the cell.

[Steps]

1. Select [View]-[Width Auto-Fit] on the menu.

#### 2) Automatic Height Adjustment

It adjusts the row height to the string height of the cell.

[Steps]

1. Select [View]-[Height Auto-Fit] on the menu.

### 11.5.17 View Properties

It is used to change the font and font size of the data value displayed on the screen. In addition, the color of the data value can be changed if in monitoring mode.

[Steps]

1. Select [View]-[View Properties] on the menu.
2. Select [Font...] to change font.
3. Select [Color...] to change color.
4. Click OK to apply the newly specified value.

[Dialog Box]

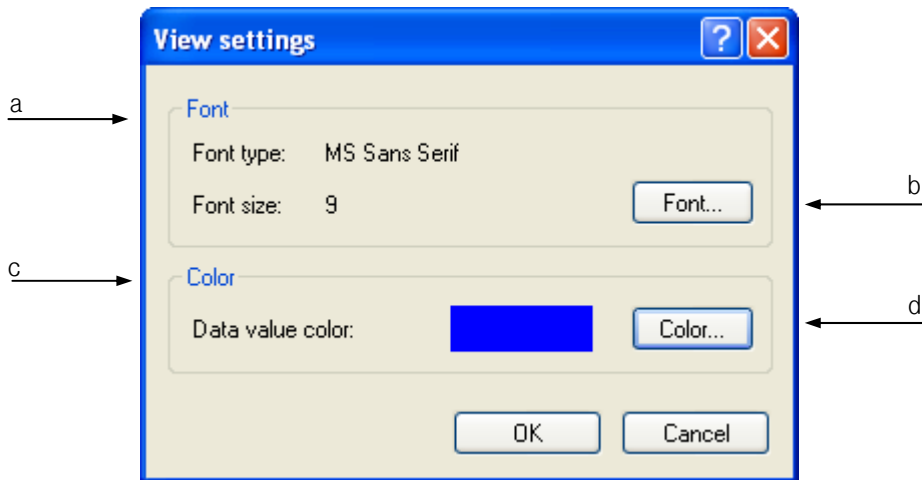

[Description of Dialog Box]

- a. Font Type, Font size: shows presently displayed font name and font size.
- b. Font: calls a dialog box to change font name and font size displayed on the screen.
- c. Data value color: displays color of data value presently specified in monitoring mode.
- d. Color: calls a dialog box to change color of data value in monitoring mode.

### 11.5.18 Page Setting

It is used to specify the device page printed.

Page margins, title and grid lines can be showed or hidden as necessary.

In addition, the sequence of pages to print can be specified with priority of row or column.

[Steps]

1. Select [File]-[Page Setup] on the menu.
2. Specify margins..
3. Show or hide title and grid lines as necessary.
4. Specify the sequence of pages to print with priority of row or column.
5. Specify the print type of the center of page, horizontal or vertical.

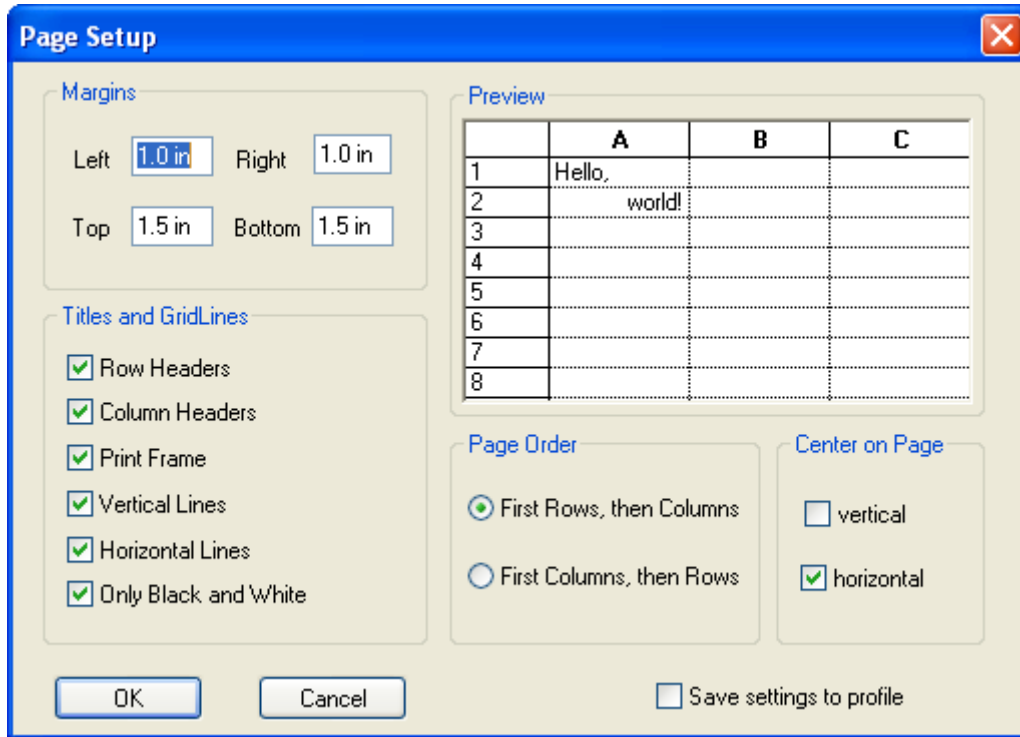



## 11.6 Special Module Monitoring

Select [Monitor]-[Special Module Monitoring] on the menu of XG5000 program to display “Special Module” list dialog box (as shown in Fig. 1). “Special Module List” dialog box displays the information list of the special module presently installed on the PLC system for the user to select a module on the list and then to click [Monitor] in order to show “Special Module Monitoring” dialog box (as shown in Fig. 2). Through the “Monitoring/Test” screen, the user can directly change the parameter value saved in the special module while checking the test operation and its status of the applicable module.

[Dialog Box]

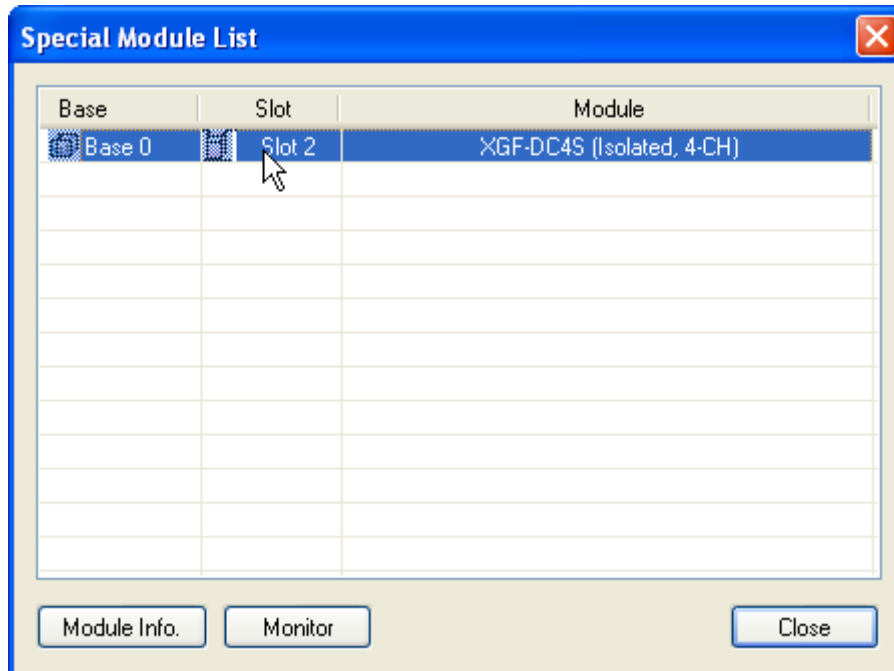

Fig. 1 Special Module Screen

**Special Module Monitor** XGF-H02A (Open-Collector, 2-CH)

**Monitoring Screen**

Item	Channel 0	Channel 1
Current Count Value		
Latch Count Value		
Range Count Value		
Input Frequency		
Revolution/Unit Time		
FLAG Monitor		<input type="button" value="FLAG Monitor"/>

**Parameter Setting Screen**

Item	Setting Value	Current Value
Channel	Channel 0	
Counter Mode	Linear	
Pulse Input Mode	2-Phs x1	
Preset	0	
Ring Counter Min.	0	
Ring Counter Max.	0	
Comp Output0 Mode	(Magnitude)<	
Comp Output0 Mode	(Magnitude)<	
Comp Output0 Min.	0	
Comp Output0 Max.	0	
Comp Output1 Min.	0	
Comp Output1 Max.	0	
Output Status Setting	Output Disable	
Auxiliary Mode	No Auxiliary	
Range Value [ms]	0	
Pulse/Rev Value	1	
Frequency Mode	1 Hz	

Buttons:

Fig. 2 Monitoring/Test Screen (High-speed Count Module)

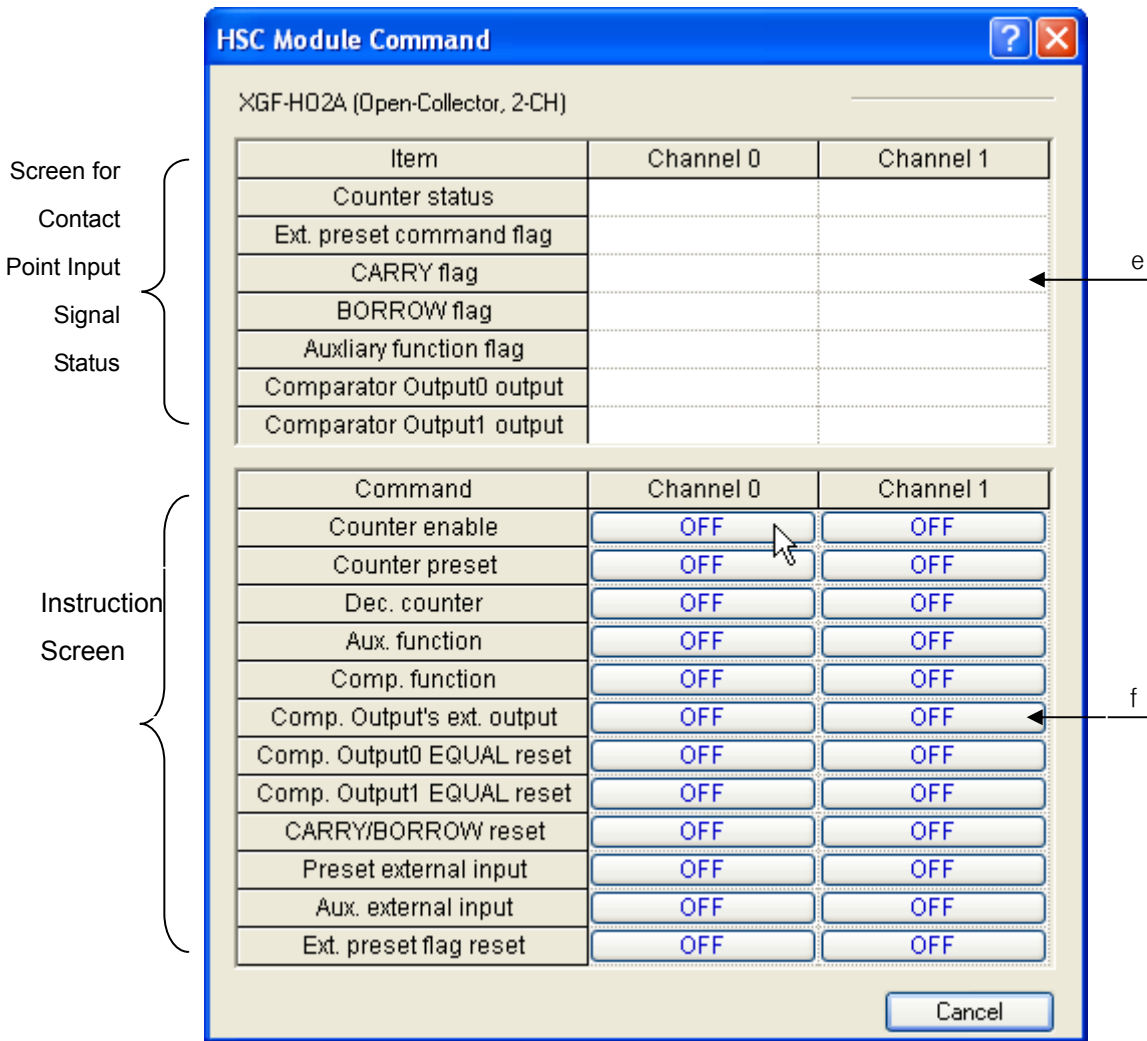

Fig. 3 Monitoring & Instruction Screen of HS Counter Module FLAG

[Description of Dialog Box]

- a. FLAG Monitor (applicable only to HS counter module): Flag monitoring function is used to execute instructions for HS counter module. The user can check the instruction and input signal status along with HS counter monitoring/test screen as well as Flag monitoring screen (refer to Fig. 2) displayed at the same time.
- b. Parameter Setting Screen: Parameter setting screen is divided into parameter changing area (setting value) and confirming area (current value) that the changed parameter is successfully transferred to the module during monitoring.
- c. Start Monitoring: Click [Start Monitoring] button to start monitoring being displayed on the screen. Click the button once more to stop monitoring.
- d. Test: After changing the parameter at the bottom of the Monitoring/Test screen, click [Test Start] button to start to test the operation of applicable special module, which will directly transfer the parameter information to the module so to display its result on the monitoring screen for the user to confirm.
- e. Contact Point Input Signal Status Screen: The user can confirm HS counter status of input contact point signal (ON/OFF) through the upper of the Flag monitoring screen.
- f. Instruction Screen: The user can execute the instruction for HS counter operation and additional functions at the bottom of the Flag monitoring screen. If the instruction is correctly executed, the status of the applicable instruction will be displayed in ON/OFF on the button.

### Notes

- a. HS counter Flag monitoring and instruction functions are available with HS counter module selected by the user on the special module screen.

## 11.7 Trend Monitoring

Trend monitoring is used to read the data periodically from PLC connected so to display in a graph. The trend monitoring window is composed of bit graph and trend graph. In the bit graph, bit device's On/Off status is displayed in stair-shaped graph. And in the trend graph, the variation trend of the data is displayed with the device value converted from word to data format specified.

### 11.7.1 Start Trend Monitoring

[Steps]

1. Connect to the PLC.
2. Select [Monitoring]-[Trend Monitoring] on the menu.

[Trend Monitoring Window]



[Description of Trend Monitoring Window]

- a. Bit graph: displays the data of bit device.
- b. Bit graph index: displays the bit graph and graph colors.
- c. Bit graph present value: displays the present value of the bit device.
- d. Trend graph: displays the data of word device.
- e. Trend graph index: displays the word device and graph colors.
- f. Trend graph present value: displays the present value of word device.

**Notes**

- a. The data displayed in the trend monitor may be different with the actual data. In order to monitor accurate timing, please use the data trace function.
- b. For the details of data trace function, refer to 11.8.

### 11.7.2 Setting Trend Monitoring

[Steps]

1. Select [Graph]-[Graph Settings] on the menu.

[Dialog Box]

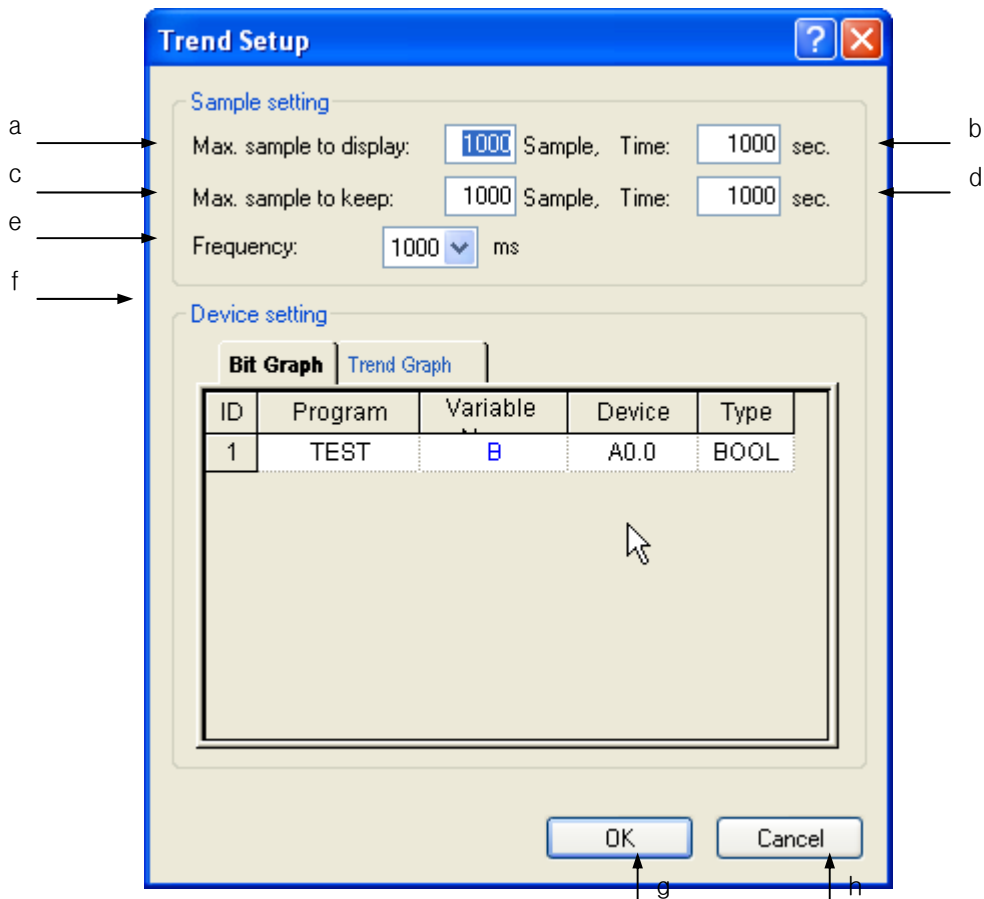

## Chapter 11 Monitoring

[Description of Dialog Box]

- Max. sample to display: displays the maximum number of samples available to scroll in the graph.
- Time: displays the maximum number of samples available for a second.
- Max. sample to keep: displays the maximum number of samples available to save on the file.
- Time: displays the maximum number of samples available to keep for a second.

### Notes

- The 'Max. samples to display' can not be greater than the 'Max. sample to keep'.
- The 'Max. time to display' can not be greater than the 'Max. time to keep'.
- The relationship between the Max. samples to keep and the Max. sample to displayed is as shown below. In the figure below, 'Graph' is of a graph area presently displayed on the screen, which is available to scroll horizontally as many as the max. samples displayed.

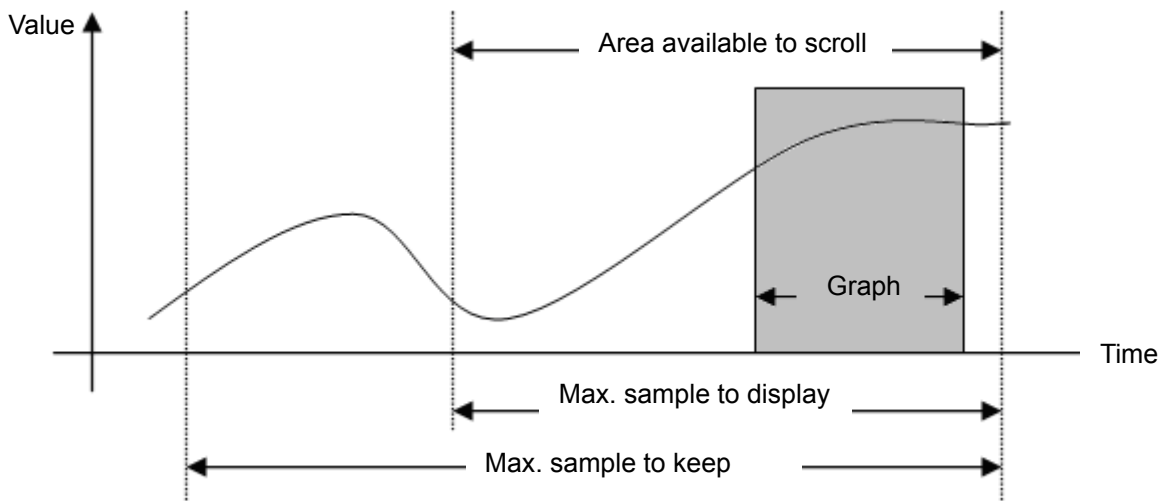

- The Max. samples to keep means the max. number of samples available to save on the file, refer to the section of 11.7.5 '8) Text'..

- Frequency: used to specify the cycle to read data from PLC. The shorter the cycle is, the more correct the data is, which may have an influence on PLC scan and PC performance, though.
- Device Setting: used to designate the device to monitor. The device can be displayed in bit or in real as specified.
- OK: applies the changed items and closes the dialog box.
- Cancel: closes the dialog box.

1) Setting Bit Device

It is used to input the bit device to monitor

[Steps]

1. Select the bit graph tap on the Setting Monitoring dialog box.
2. Input the device of bit type. Or double-click the variable column to select the declared device on the Variable/Comment dialog box.

Notes

- a. Up to 8 bit devices are available to register.

2) Setting Trend Device

It is used to input the trend device to monitor.

[Steps]

1. Select the trend graph tap on the Setting Monitoring dialog box.
2. Input the device of word type. Or double-click the variable column to select the declared device on the Variable/Comment dialog box.
3. Click the type column to select the data type.

Notes

- a. Up to 12 trend devices are available to register.
- b. Supported data types are as follows

Type	Size	Type	Size
BIT	1 bit	REAL	4 bytes
BYTE	1 byte	LREAL	8 bytes
WORD	2 bytes	INT	2 bytes
DWORD	4 bytes	DINT	4 bytes
LWORD	8 bytes	LINT	8 bytes



## 11.7.3 Setting graph

[Steps]

1. Select [Graph]-[Graph Settings] on the menu.

[Dialog Box]

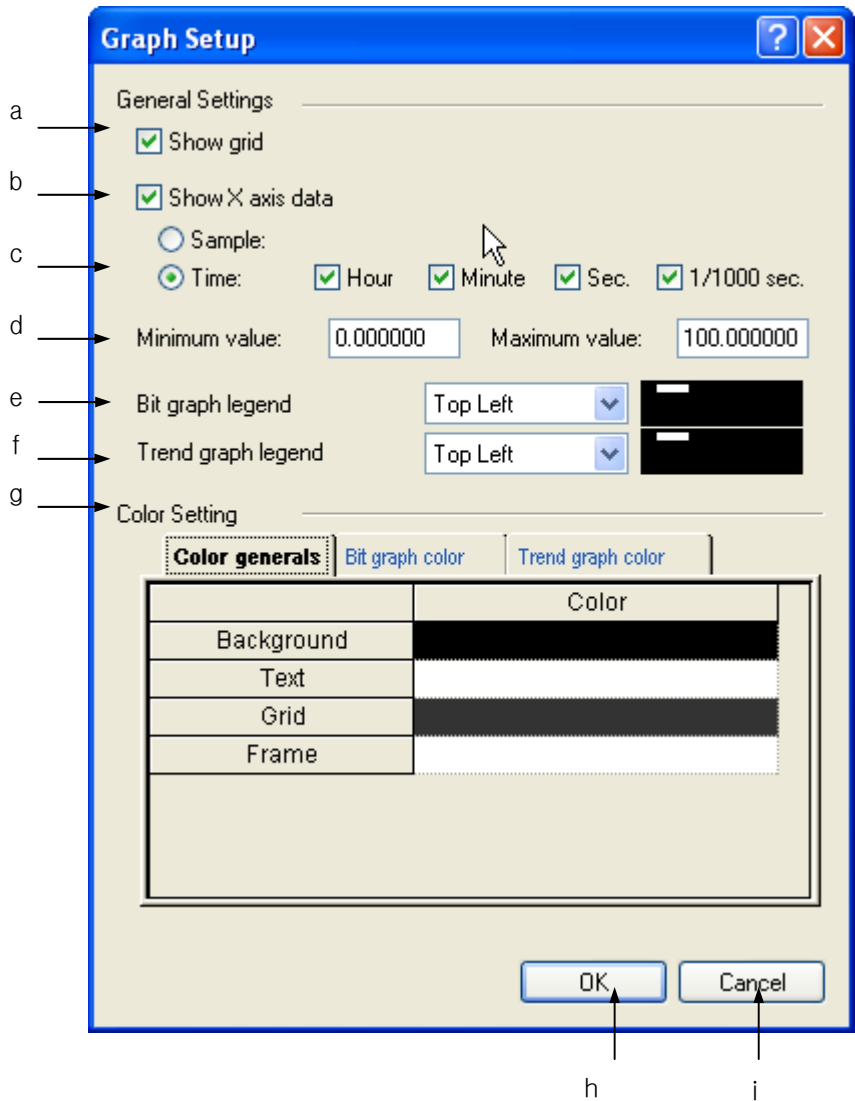

[Description of Dialog Box]

- a. Show grid: used to decide to show XY grid or not on the screen.
- b. Show X-axis data: used to decide to show X-axis data or not.
- c. X-axis data option: used to specify the display method of X-axis data.
- d. Minimum value/Maximum value: used to set the max./min. range of the graph.

Notes

- a. The max./min. value is applied only to Y-axis of the trend graph, and not applied if View Present Y-axis is automatically adjusted.
- b. The min. value input can not be greater than the max. value.
- c. The actual data's max./min. value range and specified graph's max./min. value range are as shown below. Only the range in gray will be displayed in the graph.

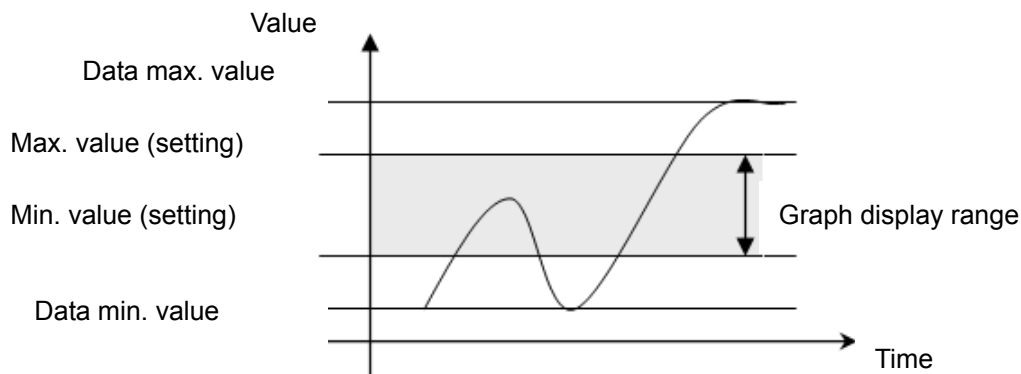

- e. Bit graph legend: used to specify the position of bit graph index. No Index, Left Upper, Right Upper, Left Bottom and Right Bottom are available for the Bit Index Position.
- f. Trend graph legend: used to specify the position of trend graph index. No Index, Left Upper, Right Upper, Left Bottom and Right Bottom are available for the Trend Index Position.
- g. Color: used to specify device color of each graph.

Notes

- a. If View Check Box is cancelled in Setting Color, its applicable device will not be displayed in the graph.

- h. OK: applies the changed items and closes the dialog box.
- i. Cancel: closes the dialog box.

## Chapter 11 Monitoring

### 1) Graph Color Settings

[Steps]

1. Select the device to change its graph color.

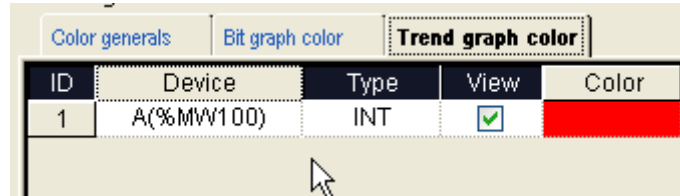

2. Click the color column to display applicable dialog box. On the dialog box, select desired color and then click [OK] button.

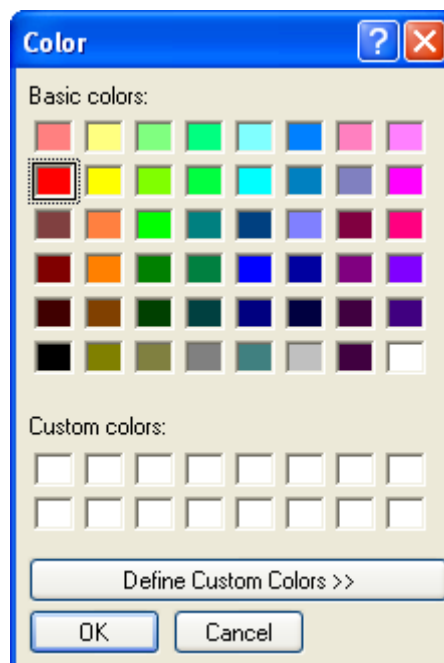

2) View Graph Option Settings

[Steps]

1. Select the device to change its Graph Option.

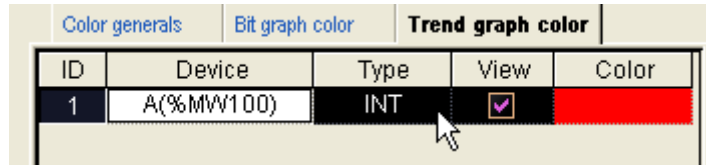

2. Select or cancel the Check Box of View Column.

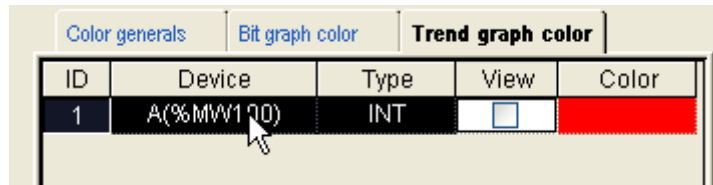

11.7.4 Setting Graph Window

It is used to decide to change View Graph Option and display the data value as necessary.

[Steps]

1. Select [Graph]-[Graph window Settings] on the menu.

[Dialog Box]

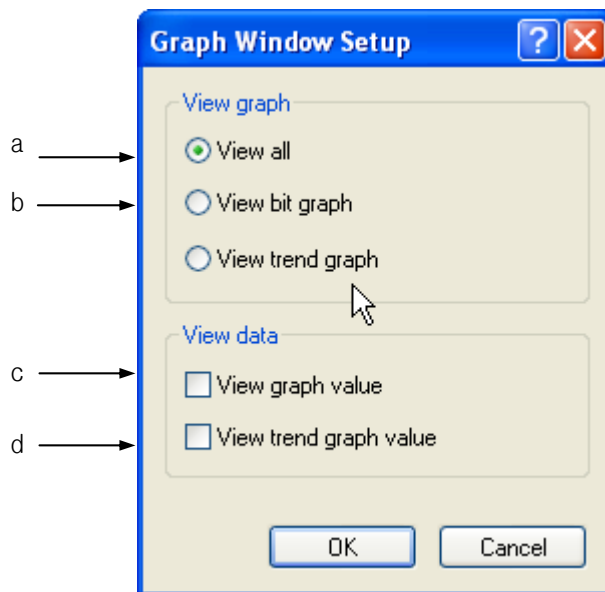

## Chapter 11 Monitoring

[Description of Dialog Box]

- a. View all: displays all the bit and trend graphs.
- b. View bit graph: displays only the bit graph.
- c. View graph value: displays only the bit graph value.
- d. View trend graph value: displays the trend graph value.

### 11.7.5 Graph function

#### 1) View Cursor

It is used to display the data value the mouse is positioned on.

[Steps]

1. Select [Graph]-[View Cursor] on the menu.
2. Click the left mouse button to select the graph. Whenever the mouse moves, the data value the cursor is positioned on will be displayed.

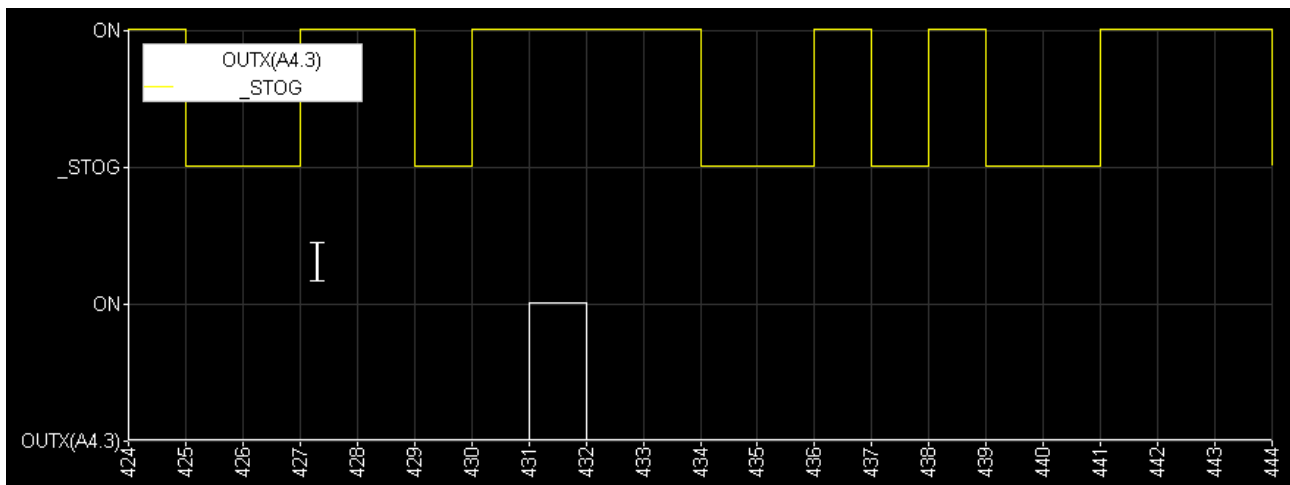

#### Notes

- a. View cursor function is only active in the state of Stop Monitoring/Pause Monitoring.

#### 2) Scroll Synchronization

It is used to decide to synchronize the bit graph with the trend graph in time axis. It is useful in monitoring the bit graph and the trend graph data with the identical time.

[Steps]

Select [Graph]-[Scroll Sync.] on the menu.

1. Move the horizontal scroll bar to scroll the bit graph and the trend graph at the same time based on Scroll Synchronization specified.

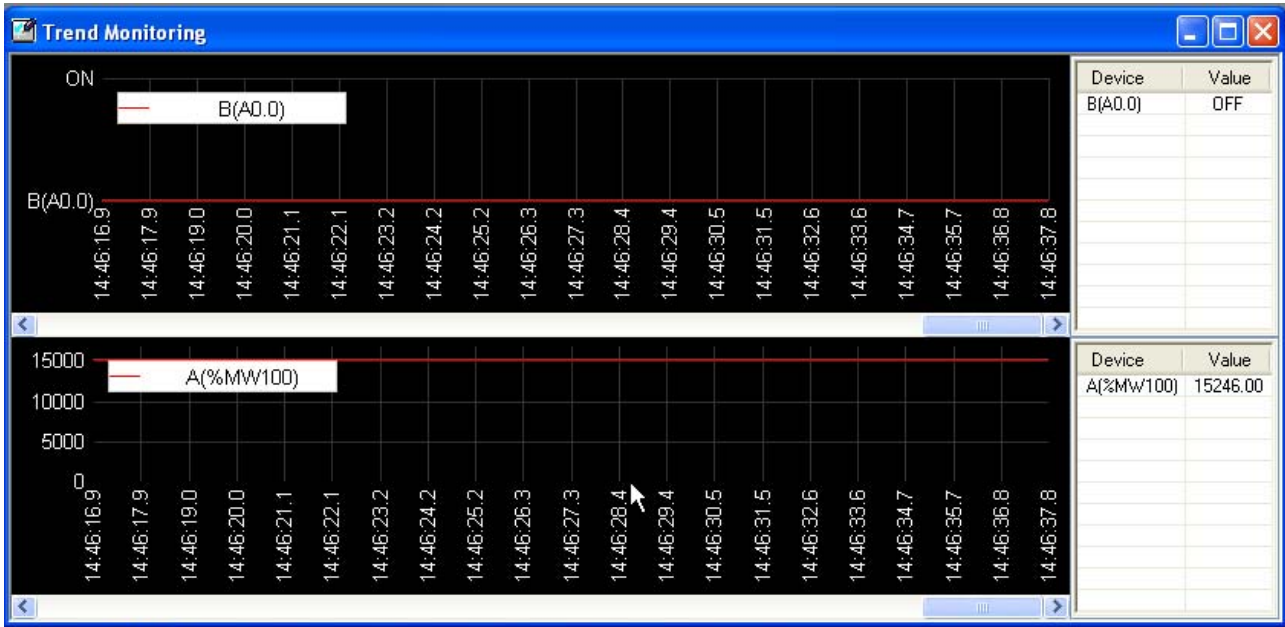

### 3) Adjust X-axis magnification

It is used to adjust X-axis magnification.

## Chapter 11 Monitoring

[Steps]

1. Select [Graph]-[Zoom In X axis], [Zoom Out X axis], [Reset X-axis] on the menu. Based on the selected item, X-axis's time interval will be increased, decreased or back to basic value.



#### 4) Adjust Y-axis magnification

It is used to adjust Y-axis magnification.

[Steps]

1. Select [Graph]-[Zoom In Y axis], [Zoom Out Y axis], [Reset Y axis] on the menu. Based on the selected item, Y-axis's height will be increased, decreased or back to basic value.

5) Adjust X-axis Automatically

It is used to decide to adjust X-axis automatically. If the automatic adjustment is set, the horizontal scroll bar will disappear and all the data can be seen at a glance.

[Steps]

1. Select [Graph]-[ Auto-Fit X axis] on the menu.

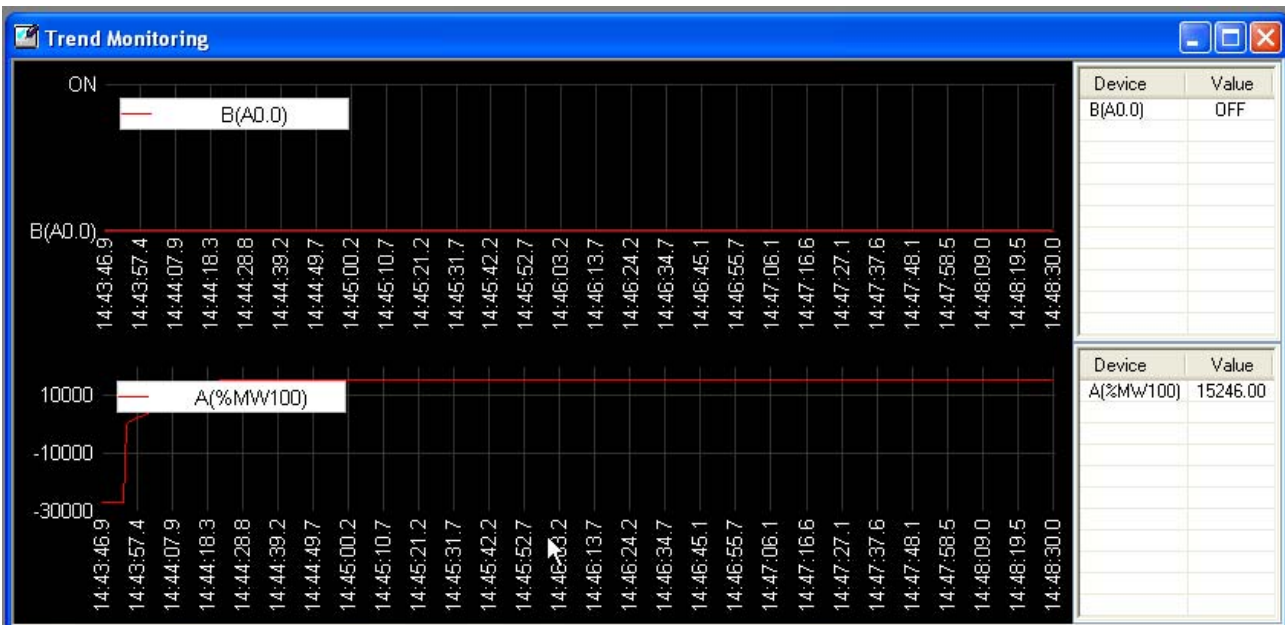

6) Auto-Fit Y-axis

It is used to decide to adjust Y-axis automatically. The automatic adjustment of Y-axis is applicable only to the trend graph.

[Steps]

1. Select [Graph]-[Auto-Fit Y-axis] on the menu.



## Chapter 11 Monitoring

### Notes

- a. If the function of Auto-fit Y axis is not selected, the display will be based on the max./min. value specified in Graph Settings.

### 7) Save as Bitmap

It is used to save the graph presently displayed on the screen on the file in window bit map.

#### [Steps]

1. Select [Graph]-[Save Trend data as Bitmap] on the menu.
2. Input a file name to save with and then click [OK].

### 8) Save as Text

It is used to save the graph data on the file in text. Samples as many as the max. samples kept specified in setting the max. graph will be saved.

#### [Steps]

1. Select [Graph]-[Save Trend data as Text] on the menu.
2. Input a file name to save with and then click [OK].

### Notes

- a. The String file will be saved in CSV format of Excel.

### 9) Copy to Clipboard

It is used to copy the graph presently displayed on the screen onto the window clipboard.

#### [Steps]

1. Select [Graph]-[Copy to Clipboard] on the menu.

## 11.8 Data Traces

Trace Data is used to specify trace condition and device to trace in PLC so to collect the data complying with the specified condition from PLC. In XG5000, applicable data read from PLC will be displayed in a graph. While being similar to the trend monitoring described in 11.7, it can collect more correct data as read from PLC.

Trace Data operates as follows.

Steps	Details
<div style="border: 1px solid black; padding: 5px; text-align: center;">Ready</div>	Confirm the connection with PLC and the Run status of PLC.
<div style="border: 1px solid black; padding: 5px; text-align: center;">Trace Setting</div>	Decide to allow trace or not, And specify trigger condition, sample properties and trace device. Refer to 11.8.2 for more details.
<div style="border: 1px solid black; padding: 5px; text-align: center;">Writing to PLC</div>	Write trace setting items on PLC. Refer to 1) Write Trace Setting Items in 11.8.4 for more details.
<div style="border: 1px solid black; padding: 5px; text-align: center;">Trace starts</div>	Start trace with specified trigger conditions automatically or with manual trace selected. Refer to 11.8.2 Setting Trace for detailed trigger setting, and 4) Start Manual Trace in 11.8.4 for detailed manual trace.
<div style="border: 1px solid black; padding: 5px; text-align: center;">Read Data</div>	Read trace data from PLC. Refer to 3) Read Trace in 11.8.4 for more details
<div style="border: 1px solid black; padding: 5px; text-align: center;">Creating a graph</div>	Refer to 11.8.2 for more details.

[Steps]

1. Select [Monitor]-[Data Traces] on the menu.

## Chapter 11 Monitoring

[Trace Data Window]

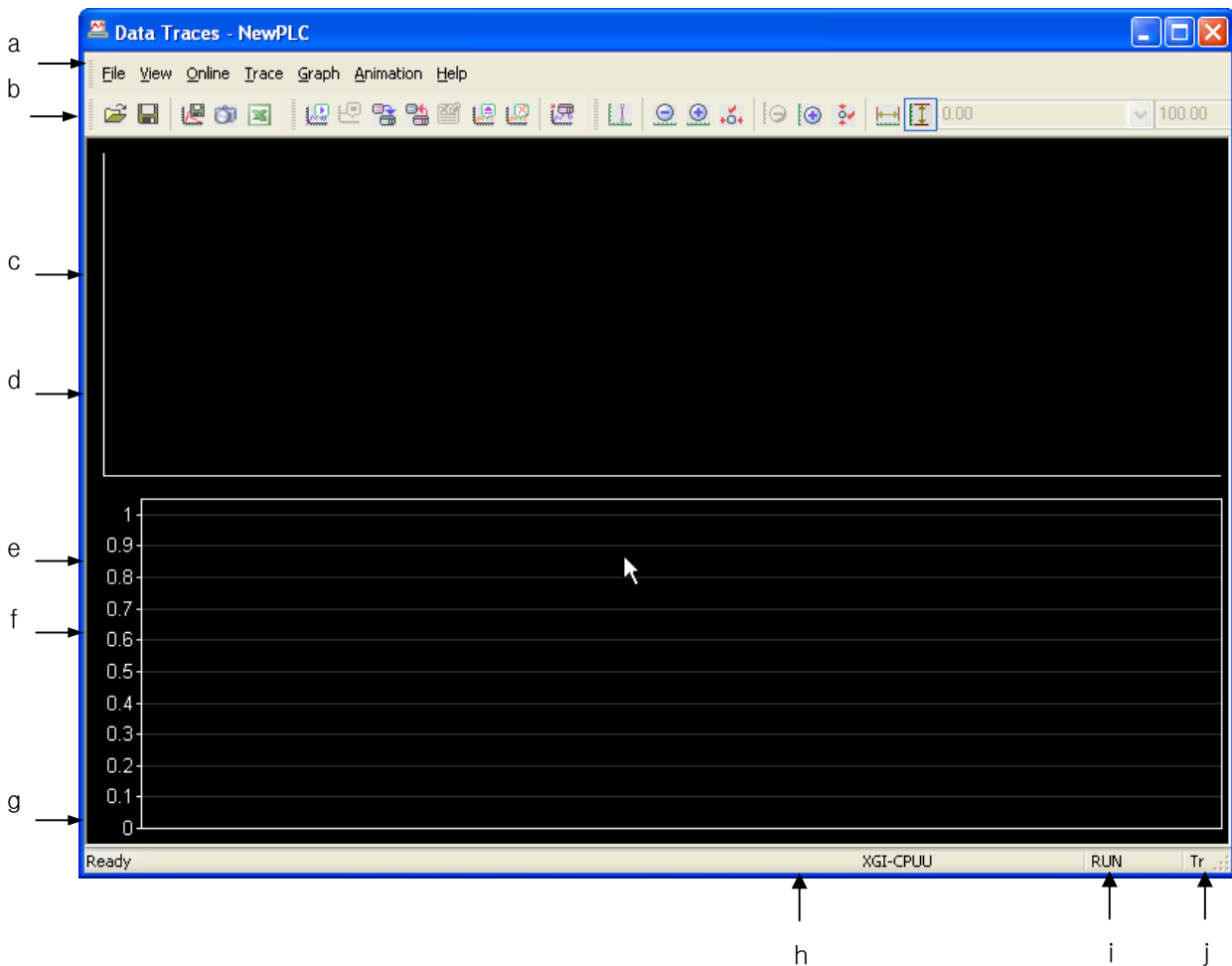

[Description of Window]

- a. Menu: displays the data trace menu.
- b. Tool Box: displays the tool box of the data trace.
- c. Bit graph Index: displays bit device and graph color.
- d. Bit graph: displays the data of bit device.
- e. Word graph Index: displays word device and graph color.
- f. Word graph: displays the data of word device.
- g. Status bar: displays the status of data trace.
- h. Progress bar: displays the progress status if data is read from PLC.
- i. PLC status: displays off-line status and the operation status of PLC.
- j. Trace status: displays the trace status of PLC.

### 11.8.1 Connect

[Steps]

1. Select [Online]-[Connect] on the menu.

**Notes**

- a. Refer to 10.1 Connect Options in XG5000 manual for details on Connect Options.

### 11.8.2 Trace Setting

It is used to specify trace conditions and trace device..

[Steps]

1. Select on the menu [Trace]-[Trace settings].

[Dialog Box]

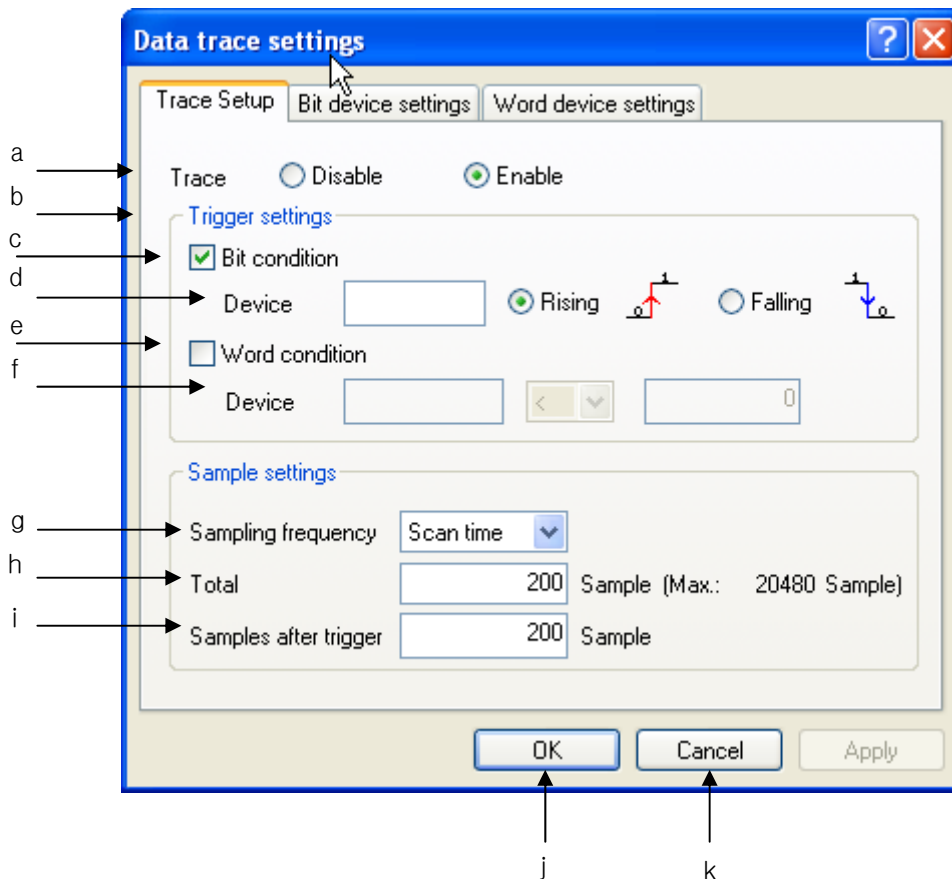

## Chapter 11 Monitoring

[Description of Dialog Box]

- a. Trace: decides to allow the trace or not.
- b. Trigger settings: specifies the condition for trace start. As a trigger condition bit condition or word condition can be selected.
- c. Bit condition: decides to use bit trigger condition or not. As for bit trigger setting, refer to 1) Setting Bit Trigger item.
- d. Device: specifies the device to monitor the bit trigger condition.
- e. Word condition: decides to use word trigger condition or not. As for word trigger setting, refer to 2) Setting Word Trigger item.
- f. Device: specifies the device to monitor the word trigger condition.
- g. Sampling frequency: specifies the cycle to collect data.
- h. Total sample: specifies the number of samples in total to collect. The number of samples in total will be decided based on the input sample device.
- i. Samples after trigger: specifies the number of samples to collect after triggered.
- j. OK: saves the changed items and closes the dialog box.
- k. Cancel: closes the dialog box.

### Notes

- a. Use the number of samples in total and the number of samples after triggered to apply various collection methods.
  - Number of Samples in Total = Number of Samples after triggered: a method to collect data after triggered, which will be used when the data before triggered is not necessary.
  - Number of Samples in Total > Number of Samples after triggered ( $\neq 0$ ): a method to collect data even before triggered, which will be used when the data before and after triggered is necessary.
  - Number of Samples after triggered = 0: a method not to collect data after triggered, which will be used when the data after triggered is not necessary

### 1) Setting Bit Trigger

It uses the variation of the bit device value as a trigger condition.

[Steps]

1. Select the check box of bit condition.
2. Input the device to use as a bit condition. Bit device format only is available.
3. Specify trigger condition, where rising or falling is available. Rising means that the device value changes from 0 to 1, and falling means that the device value changes from 1 to 0.

### 2) Setting Word Trigger

It uses the variation of the word device value as a trigger condition.

[Steps]

1. Select the check box of word condition.
2. Input the device to use as a word condition. Word device format only is available.
3. Input constant value to compare with word device value.
4. Select a condition to use to compare with the constant value input. Available conditions are as follows.  
< (less than), <= (less than or equal to), == (equal to), >= (greater than or equal to), > (greater than),

### 3) Bit device settings

It is used to select the bit device to collect data. The selected device will be displayed in a bit graph.

[Steps]

1. Select the Bit device settings tap on dialog box of Data Trace Settings.

[Dialog Box]

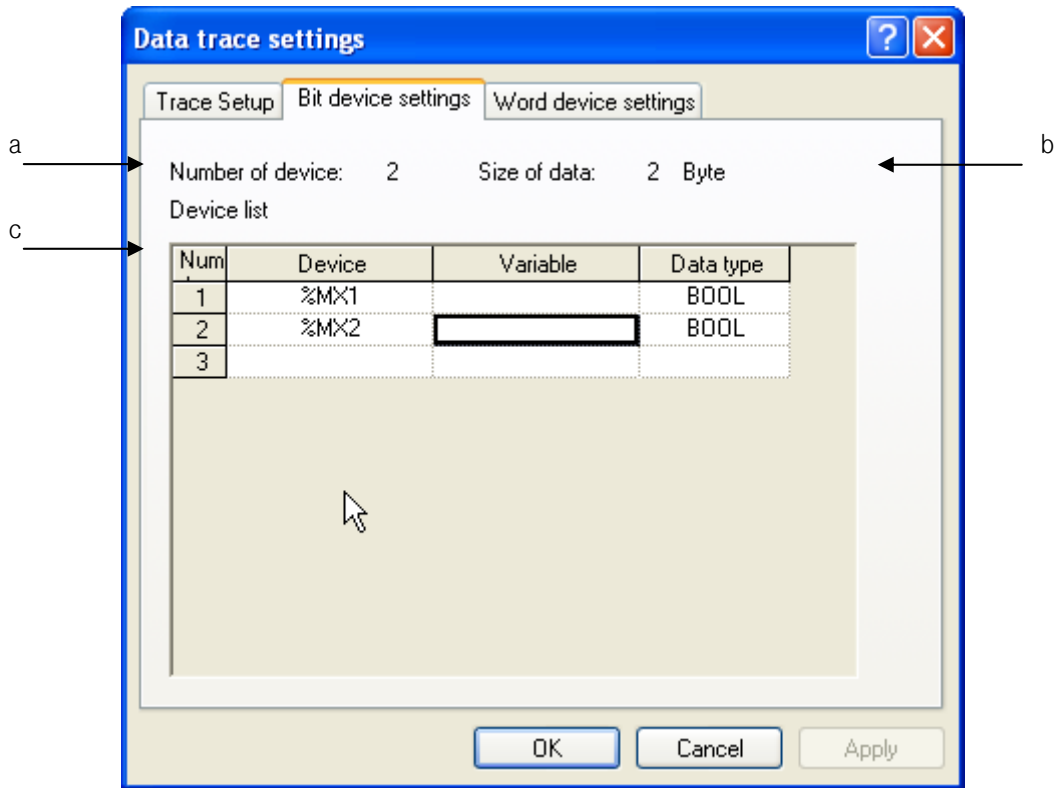

[Description of Dialog Box]

- a. Number of devices: displays the number of bit devices specified.
- b. Size of data: displays the size of the data specified. More than 1 bit device will be displayed in 2 bytes.
- c. Device list: displays the list of the bit devices specified.
- d. Input the device of bit type. Click the right mouse button and select [Add Line] to add a line. Click the right mouse button and select [Delete Line] to delete the device input.

**Notes**

- a. Devices of bit type can be input up to 16.

#### 4) Word Device Settings

It is used to select the word device to collect data. The selected device will be displayed in a word graph.

[Steps]

1. Select the word device setting tap on dialog box of Data Trace Settings.

[Dialog Box]

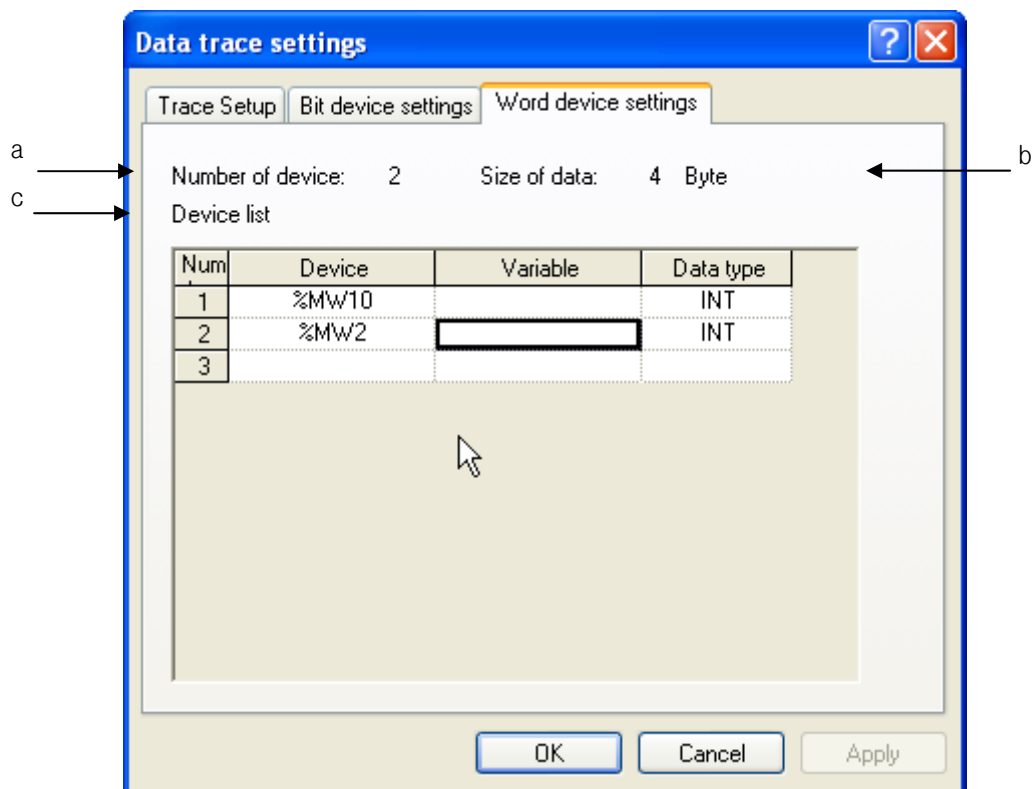

[Description of Dialog Box]

- a. Number of device: displays the number of word devices specified.
- b. Size of data: displays the size of the data specified. The size will be decided based on the specified data type.
- c. Device list: displays the list of the word devices specified.
- d. Input the device of word type.
- e. Select the data type of device.



## Chapter 11 Monitoring

### Notes

- a. Devices of word type can be input up to 8.
- b. Supported data types are as follows.

Type	Size	Type	Size
SINT	1 byte	REAL	4 bytes
INT	2 bytes	LREAL	8 bytes
DINT	4 bytes	INT	2 bytes
LINT	8 bytes	DINT	4 bytes
USINT	1 byte	LINT	8 bytes

### 11.8.3 Setting Graph

[Steps]

Select [Graph]-[Graph Settings] on the menu.

[Dialog Box]

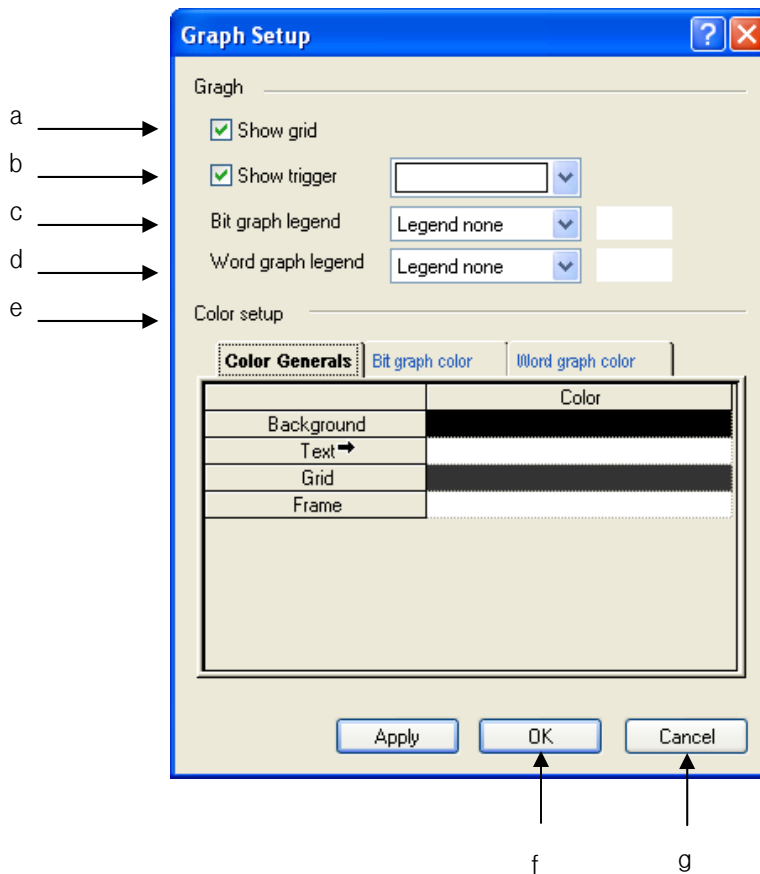

[Description of Dialog Box]

- a. Show grid: used to decide to show XY grid or not on the screen.
- b. Show trigger: used to decide to display the trigger position on the graph, and to specify color.
- c. Bit graph legend: used to specify the position of bit graph index. No Index, Left Upper, Right Upper, Left Bottom and Right Bottom are available for the Bit Index Position.
- d. Word graph legend: used to specify the position of word graph index. No Index, Left Upper, Right Upper, Left Bottom and Right Bottom are available for the Word Index Position.
- e. Color setup: used to specify device color of each graph.
- f. OK: applies the changed items and closes the dialog box.
- g. Cancel: closes the dialog box.

### 1) Graph Color Setting

[Steps]

1. Select the device to change its graph color.

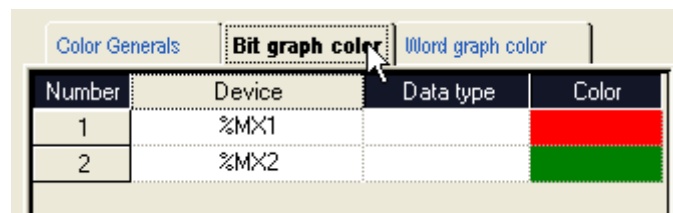

2. Click the color column to display applicable dialog box. On the dialog box, select desired color and then click [OK] button.

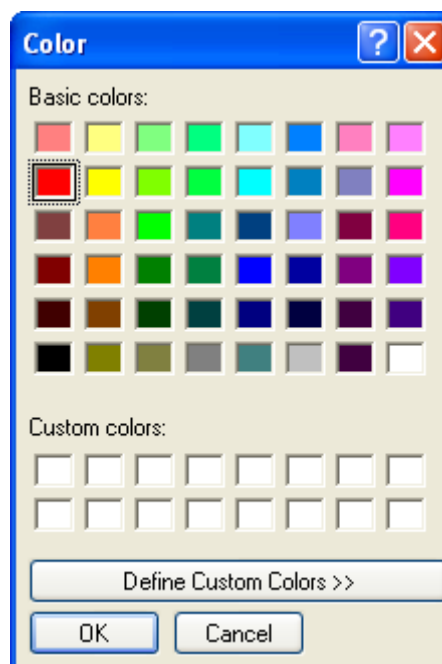

### 11.8.4 Trace

It is used to read the data traced from PLC or the data specified.

#### 1) Write Trace Setting

It applies the trace setting to PLC.

[Steps]

1. Select [Trace]-[Write Trace Settings] on the menu.

#### 2) Read Trace Settings

It is used to read trace setting from PLC.

[Steps]

1. Select [Trace]-[Read Trace Settings] on the menu.

#### 3) Read Data Traces

It reads trace data from PLC.

[Steps]

1. Select [Trace]-[Read Trace] on the menu.

#### 4) Start Manual Trace

It is used to start to trace data under the trace condition presently specified.

[Steps]

1. Select [Trace]-[Start Manual Trace] on the menu. If data is presently traced, the applicable menu will be inactive.

### 11.8.5 Animation

Using the trace data read from PLC, it displays the data in the sequence of time.

#### 1) Animation Settings

[Steps]

1. Select [Animation]-[Animation Setting] on the menu.

[Dialog Box]

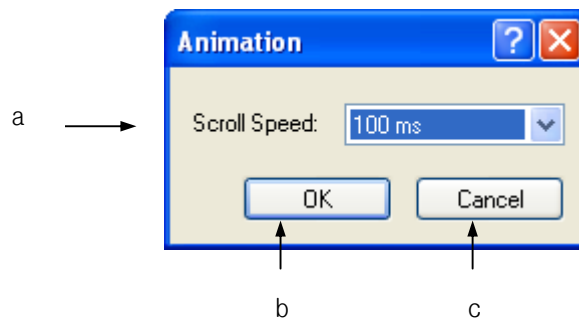

[Description of Dialog Box]

- a. Frequency: used to specify the cycle to update the data sample on the screen. Available data update cycles are 20, 50, 100, 200, 500, 1000 and 2000ms value.
- b. OK: applies the changed items and closes the dialog box.
- c. Cancel: closes the dialog box.

#### 2) Start

It is used to start Simulation. Simulation will be active only with trace data available.

[Steps]

1. Select [Animation]-[Start Animation] on the menu.

#### 3) Pause

It is used to stop Simulation in progress momentarily.

[Steps]

1. Select [Animation]-[Animation Pause/Resume] on the menu.

#### 4) Resume

It is used to continue Simulation which was momentarily stopped.

[Steps]

1. Select [Animation]-[Animation Pause/Resume] on the menu.

### 5) Stop

It is used to stop Animation.

[Steps]

1. Select [Animation]-[Stop Animation] on the menu.

### 11.8.6 Graph Function

Refer to 11.7.5 Graph Function in this manual for its basic functions.

#### 1) Move Trigger

It moves the trigger to its generated point of time.

[Steps]

1. Select [Graph]-[Go to Trigger Position] on the menu.

### 11.8.7 File function

It is used to save or read trace setting from the file.

#### 1) Open

[Steps]

1. Select [File]-[Open] on the menu.
2. Select a file name to open on File dialog box and then click [OK].

#### 2) Save

[Steps]

1. Select [File]-[Save] on the menu.
2. Input a file name to save with on File Save Box and then click [OK].

#### 3) Save as

[Steps]

1. Select [File]-[Save As] on the menu.
2. Input a different file name to save with on File Save Box and then click [OK].

### 4) Save as Bit Map

It is used to save the graph presently displayed on the screen on the file in window bit map.

[Steps]

1. Select [File]-[Send]-[Save as Bitmap] on the menu.
2. Input a file name to save with and then click [OK].

### 5) Save Text

It is used to save the graph data on the file in text. Samples as many as the max. samples kept specified in setting the max. graph will be saved.

[Steps]

1. Select [File]-[Send]-[Save Trace data as Text] on the menu.
2. Input a file name to save with and then click [OK].

### 6) Copy Clipboard

It is used to copy the graph presently displayed on the screen onto the window clipboard.

[Steps]

1. Select [File]-[Send]-[Copy to Clipboard] on the menu.

## 11.8.8 View Function

This function is used to display or hide the tool bar and the status display line on the screen.

### 1) View Tool Bar

[Steps]

1. Select/Cancel [View]-['Tool Name'] on the menu.

### 2) View Status Display Line

[Steps]

1. Select/Cancel [View]-[Status bar] on the menu.

## Chapter 11 Monitoring

---

### 3) Data

It displays trace data in value. View Data will be active only with trace data available.

[Steps]

1. Select [View]-[Trace Data] on the menu.

[Dialog Box]

**Trace Data**

**Trace Info.**

Sampling frequency: Scan      Trigger time: 2007-07-04 17:26:17:925  
 Total samples: 200      Number of samples after triggering: 200

[View Settings](#)

	%MX1	%MX2	%Mw10	%Mw2
0	OFF	OFF	0.00	0.00
1	OFF	OFF	0.00	0.00
2	OFF	OFF	0.00	0.00
3	OFF	OFF	0.00	0.00
4	OFF	OFF	0.00	0.00
5	OFF	OFF	0.00	0.00
6	OFF	OFF	0.00	0.00
7	OFF	OFF	0.00	0.00
8	OFF	OFF	0.00	0.00
9	OFF	OFF	0.00	0.00
10	OFF	OFF	0.00	0.00
11	OFF	OFF	0.00	0.00
12	OFF	OFF	0.00	0.00
13	OFF	OFF	0.00	0.00
14	OFF	OFF	0.00	0.00
15	OFF	OFF	0.00	0.00
16	OFF	OFF	0.00	0.00
17	OFF	OFF	0.00	0.00
18	OFF	OFF	0.00	0.00
19	OFF	OFF	0.00	0.00
20	OFF	OFF	0.00	0.00
21	OFF	OFF	0.00	0.00
22	OFF	OFF	0.00	0.00
23	OFF	OFF	0.00	0.00
24	OFF	OFF	0.00	0.00
25	OFF	OFF	0.00	0.00
26	OFF	OFF	0.00	0.00
27	OFF	OFF	0.00	0.00

[Close](#)



## Chapter 11 Monitoring

---

[Description of Dialog Box]

- a. Trace info: displays the trace sampling cycle.
- b. View Settings: displays the trace details.
- c. Data Grid: displays the current value specified in the sequence of the samples. The sample data will be displayed in negative before triggered, and in positive after triggered.
- d. Minimum, Maximum, Average: displays the Min., Max., and Average value per device.
- e. Close: closes the dialog box.

## 11.9 PID Monitor

At PID monitor, you can set data value by loop unit and monitor it for PID control. XGI/XGR supports 8 blocks (256 loops). Representative function of PID monitor is as follows.

- 1) Read/Write PID data from PLC
- 2) Read/Save PID data from file
- 3) PID monitor/setting
- 4) PID trend view

### 11.9.1 Basic instructions

[Sequence]

Select [Monitor]-[PID monitor].

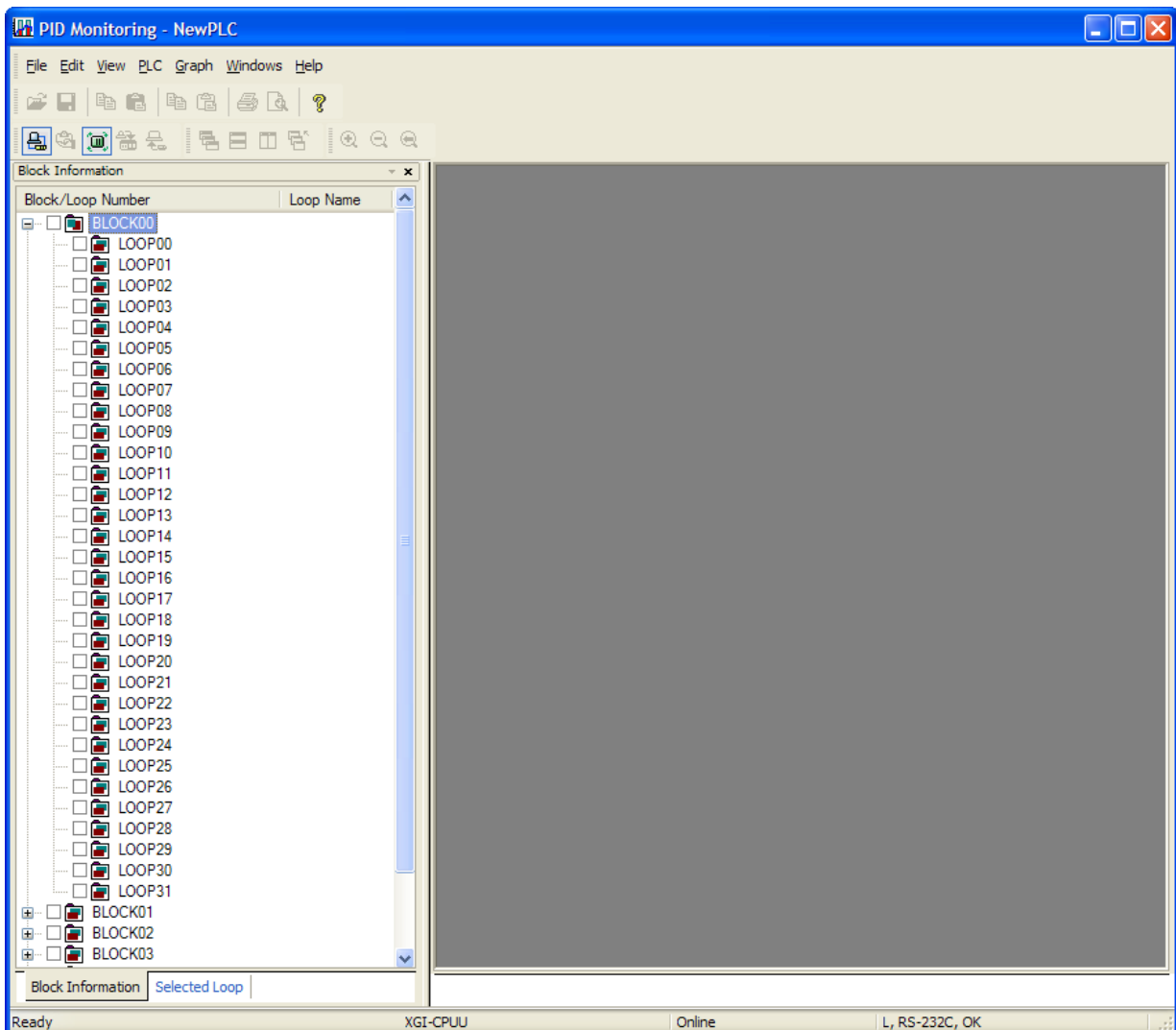

## Chapter 11 Monitoring

At block information window, select block, loop you want.

If you double-click loop or press enter, loop monitor window shows up.

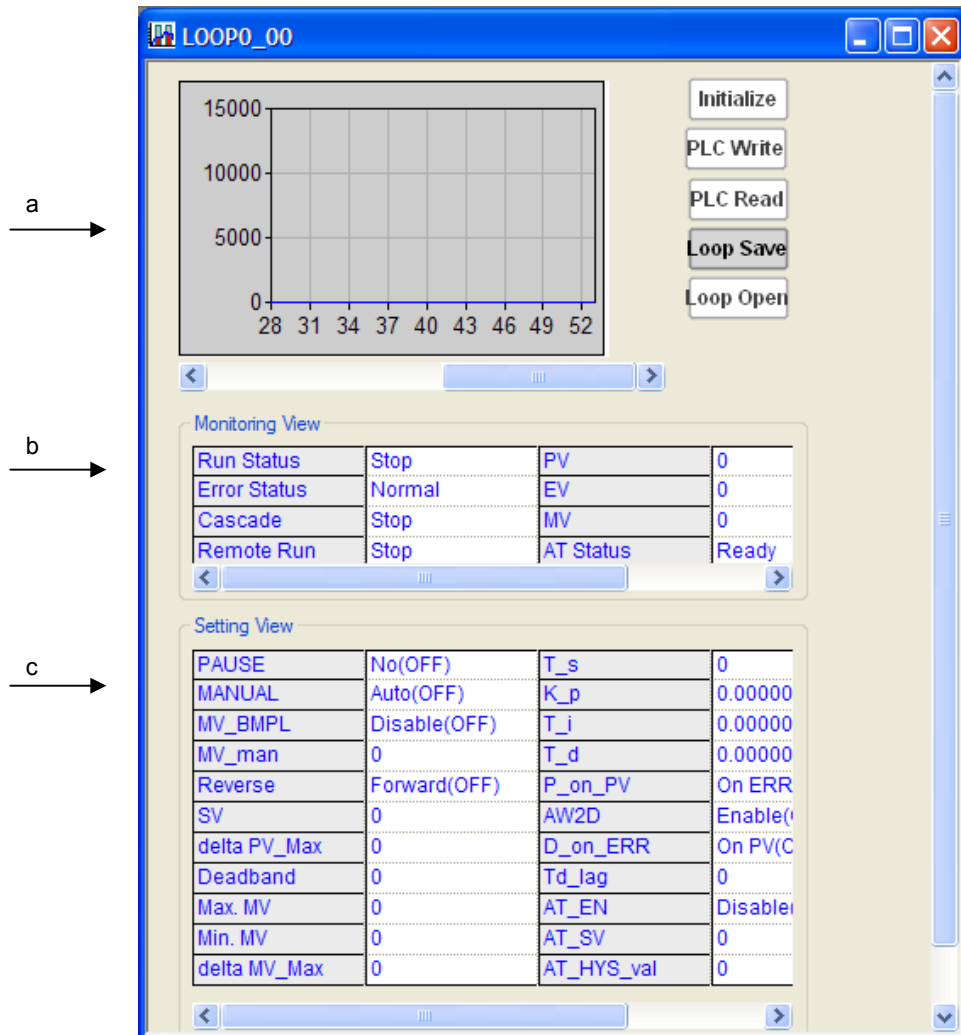

[Detail description]

- Graph: indicates PV (Present Value), MV (Manipulated Value), SV (Setting value) among PID monitor value as trend graph
- Monitor window: monitors real data value of PID variable, you can't edit value in the monitor window
- Detail setting window: indicates value of setting item adjusting monitor value. The user can edit at online/off line.

### Note

PID monitor can set up to 256 loops but the number of loop can be monitored simultaneously is limited to 32. So in case of using loop exceeding 32, warning window shows up.

### 11.9.2 Save file

It saves PID data value into file.

#### 1) Save All Loops

[Sequence]

Select menu [File]-[Save All Loops]

After inputting file name, press 'Save' button

#### 2) Save Block

#### How to save at menu

[Sequence]

Select [File]-[Save Block]

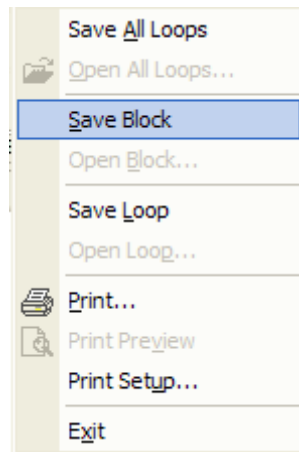

Select block number to save and press OK

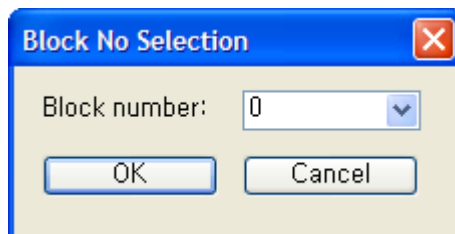

After inputting file name, press 'Save' button

## Chapter 11 Monitoring

### How to save at block information window

[Sequence]

Select block to save at block information window

Push the right button of mouse and select [Save Block]

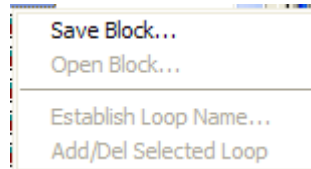

After inputting file name, press 'Save' button

### 3) Save Loop

### How to save at block information window

[Sequence]

Select loop to save at block information window

Push the right button of mouse and select [Save Loop]

After inputting file name, press 'Save' button

### How to save at loop monitor window

[Sequence]

Push 'Loop Save' button at loop monitor window

After inputting file name, press 'Save' button

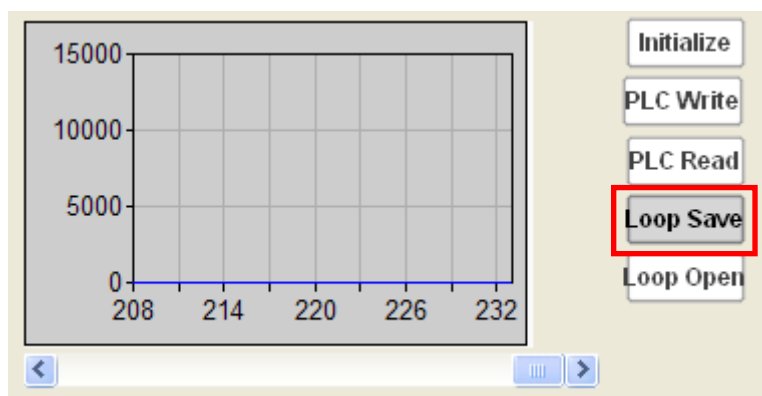

#### Note

Extension per file type is as follows

- Save All Loops: ppc
- Save Block: ppb
- Save Loop: ppl

### 11.9.3 Open file

Reads PID data setting value from file

#### 1) Open All Loops

[Sequence]

Select [File]-[Open All Loops]

After inputting file name, push 'Open' button

#### 2) Open Block

#### How to open at menu

[Sequence]

Select [File]-[Open Block] at menu

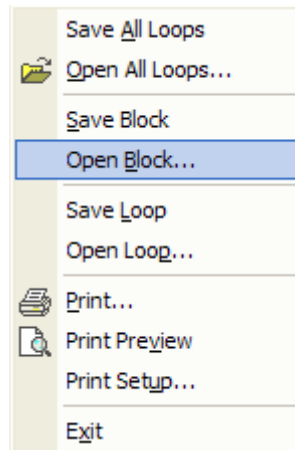

Select Block number to open and press OK

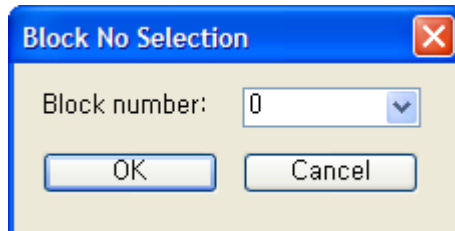

After inputting file name, push 'Open' button

## Chapter 11 Monitoring

### How to open at block information window

[Sequence]

Select block to open at block information window

Press the right button of mouse and select [Open Block]

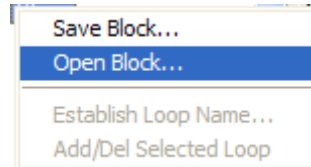

After inputting file name, push 'Open' button

### 3) Open Loop

#### How to open at block information window

[Sequence]

Select loop to open at block information window

Press the right button of mouse and select [Open Loop]

After inputting file name, push 'Open' button

#### How to open at loop monitor window

[Sequence]

Press Open Loop button at loop monitor window

After inputting file name, push 'Open' button

### 11.9.4 Setting/adjustment of loop name

It is used to name PID loop

[Sequence]

Press the right button at block information window and select [Establish Loop Name]

Input name you want and press OK

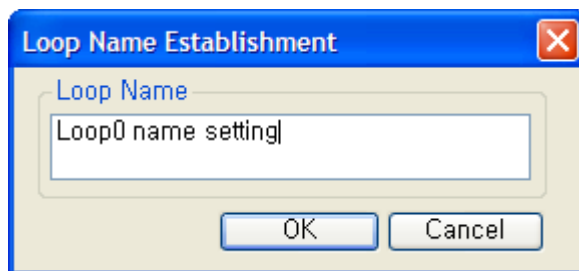

Check name of loop

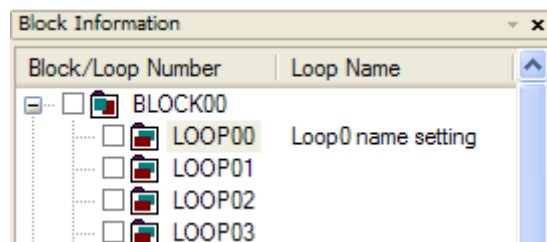

#### Note

You can set/adjust loop name at Selected Loop tap of block information window



### 11.9.5 Add/Delete selected loop

It is function to monitor easily selected loop the user uses frequently among maximum 256 loops.

#### Add selected loop

[Sequence]

Push the right button at block information window and select [Add/Del Selected Loop]

Check if check box in front of loop number is set or not at block information window

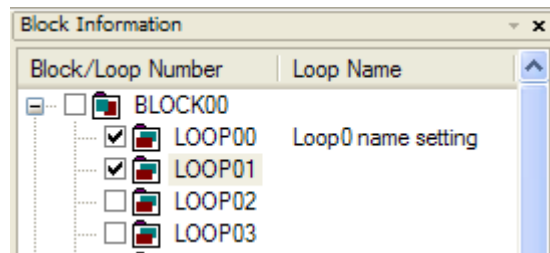

Check if selected loop is added or not at Select Loop tap of block information window

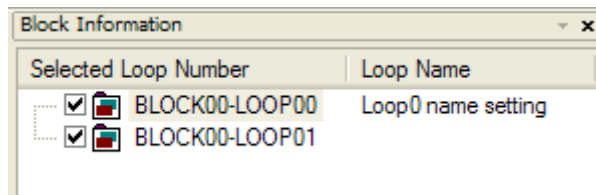

#### Delete selected loop

[Sequence]

Push the right button and select [Add/Del Selected Loop] at block information window

Check if check box in front of loop number is canceled or not at block information window.

You can cancel at Selected Loop tap.

Check if selected loop is not deleted or not at selected loop tap of block information window.

#### Note

You can add/delete loop or block by clicking check box of block information window.

### 11.9.6 Print/Print Preview

It is function to print/print preview the activated loop monitor window and detail setting window

#### Print Preview

[Sequence]

Select [File]-[Print Preview]

#### Print function

[Sequence]

Select [File]-[Print] or [Print] at preview window

#### Note

Print/Print Preview supports only one loop at one time

### 11.9.7 Connection to PLC

Connects PID monitor to PLC

After connecting PLC at XG5000, if you execute PID monitor at XG5000, PID monitor connect to PLC and it converts monitor mode

[Sequence]

Sets connection method through [PLC]-[Connection Settings]

Select [PLC]-[Connection]

### 11.9.8 Write loop data to PLC

It writes data value to PLC by loop unit. You can check progress through progress bar at bottom of PID monitor

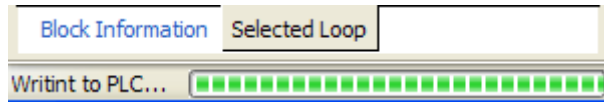

[Sequence]

- Select loop at block information window
- Open loop monitor window by double-clicking
- Input the value at detail setting window of loop monitor window
- Push the PLC Write button or select [PLC]-[Write Loop]

### 11.9.9 Write all data to PLC

It writes all loop data to PLC. You can check progress through progress bar at bottom of PID monitor

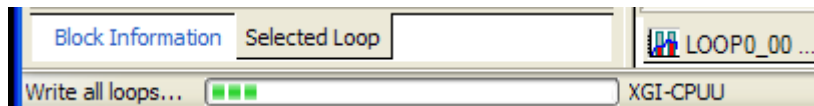

[Sequence]

- Select [PLC]-[Write All]

### 11.9.10 Read loop data from PLC

It reads data value from PLC by loop unit. You can check progress through progress bar at bottom of PID monitor

[Sequence]

- Select loop at block information window
- Open loop monitor window by double-clicking
- Push the PLC Read button at loop monitor window or select [PLC]-[Read Loop]

### 11.9.11 Read all data from PLC

It reads all loop data from PLC. You can check progress through progress bar at bottom of PID monitor

[Sequence]

Select [PLC]-[Read All]

### 11.9.12 Monitor start/end

#### 1) Start Monitoring

It reads PID data value in PLC connected and indicates at screen

[Sequence]

Check if PLC is connected

Select [PLC]-[Start Monitoring]

#### 2) End Monitoring

It stops monitoring PID data value of PLC

[Sequence]

Select [PLC]-[End Monitoring]

#### Note

In case of monitor mode, you can't edit detail setting. You can change setting value only by [Edit]-[Change Current Value]

In case of monitor mode, you can't execute [PLC Write], [PLC Read], [Loop Open] and [Loop Save] is only available.

## Chapter 11 Monitoring

### 11.9.13 Change current value during monitoring

It sets data necessary to PID control

If you want to use all data relevant to loop to PLC, refer to 11.9.8.

[Sequence]

If it is not monitor mode, select [PLC]-[Start Monitoring]

Select block and loop you want at block information window

Open relevant loop by double-clicking relevant loop or using ENTER key

Move the mouse to cell you want to set at loop monitor window

Push the right button and select [Change Current Value] or push the ENTER key

Change value and press OK

[Dialog box]

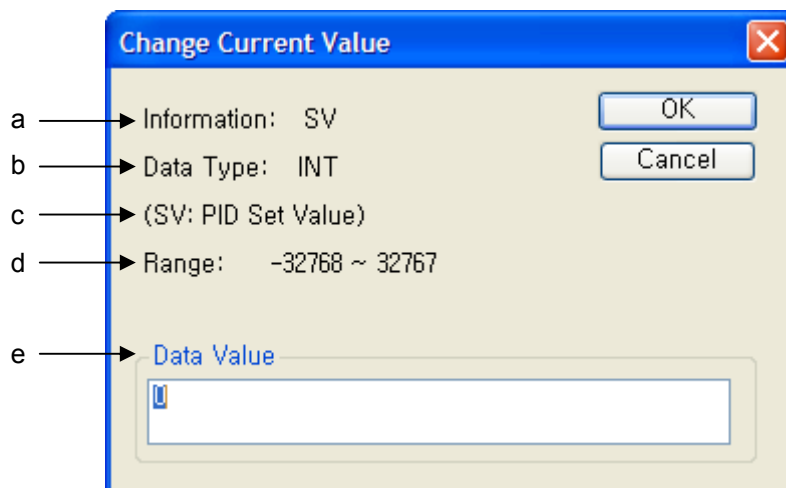

[Dialog box description]

- a. Information: indicates PID information to set
- b. Data Type: indicates data type of PID information to set
- c. Parenthesis information: indicates detail meaning of setting information
- d. Tolerance range: indicates data value range of PID information to set
- e. Data Value: indicates data value to set

#### Note

[Current Value Change] function is activated in case of monitor status

Data relevant to detail setting at loop monitor is available to write, and monitor window part can't be changed.

### 11.9.14 Graph

It indicates PV (Present Value), MV (Manipulated Value), (Setting Value) among PID monitoring value as graph

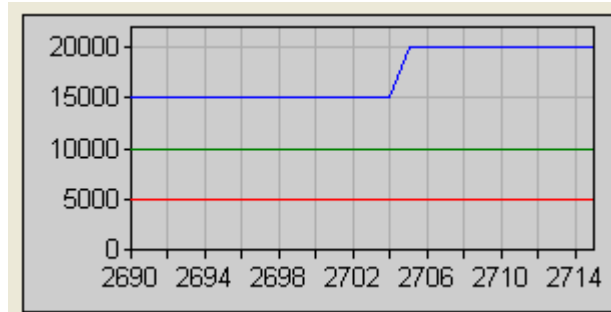

In case of changing PID flag value of XG5000 or changing detail setting value at PID monitor during monitoring, it is reflected in real time. In case of stopping monitoring, graph also stops. And in case of restarting monitoring, it draws again from last run time. The horizontal axis is renewed every 1 second

### 11.9.15 Graph related function

#### 1) Horizontal scroll bar

If 25 second passes after starting monitoring, horizontal scroll is created automatically

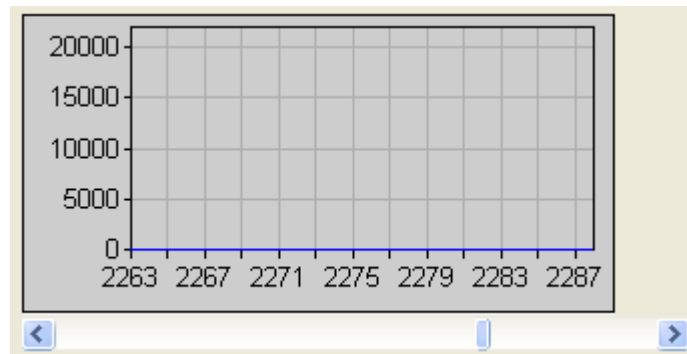

If you press both end arrow of scroll, time line increases/decreases by 1. And if you press both blank. Time line increases/decreases by 10.

#### 2) Vertical scroll bar

It is used to adjust vertical interval and see value more detail or inclusively

[Sequence]

Push [Graph]-[Zoom In Y-axis] or [Graph]-[Zoom Out Y-axis]

#### Note

Enlargement of Y axis is supported up to 4 steps

- In order to restore previous status, select [Graph]-[Return Zoom]

## Chapter 11 Monitoring

### 3) Graph color setting

It is used to change color of PV (Present Value), MV (Manipulated Value), SV (Setting Value) graph

[Sequence]

Select [Graph]-[Graph Color Setting]

Select graph color part you want to change

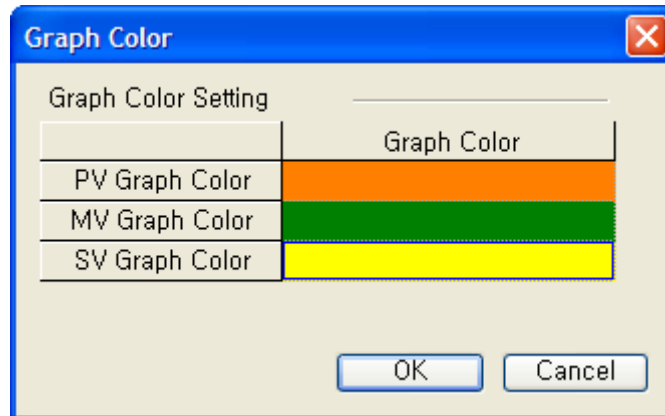

Select color at color table and press OK

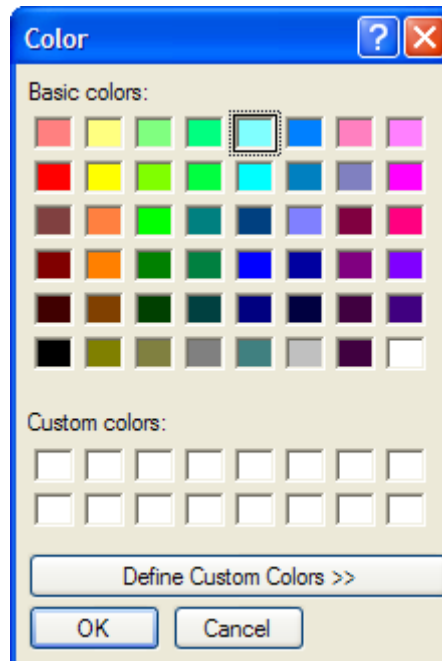

Check the change of graph color

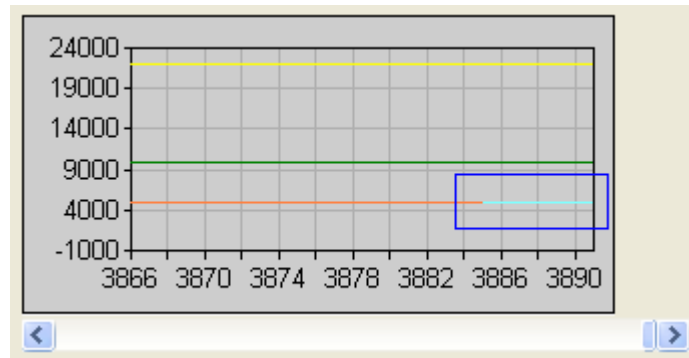

#### 4) Graph initialization

Delete accumulated graph and draw again

[Sequence]

Select [Graph]-[Graph Initialization]

Check graph is renewed from time line 0

### 11.9.16 Edit function

#### 1) Cell copy

It is used to execute copy of cell unit among detail setting value of PID monitor

[Sequence]

Select cell to copy and after pressing the right button of mouse, select [Cell Copy]

#### Note

Since copy of bit data is not possible, [Cell Copy] menu is not activated.

#### 2) Cell Paste

It is used to paste value with cell unit among detail setting value of PID monitor

[Sequence]

Select cell to copy and after pressing the right button of mouse, select [Cell Copy]

Select [Cell Paste] after pressing the right button of mouse at cell you want to paste



### Note

When Cell Copy is not executed, [Cell Paste] is not activated  
Cell Paste function is supported at same data type  
When pasting different data type, warning window occurs  
When selecting more than one cell, Cell Copy/Paste is not possible

### 3) Setting Copy

It is used to copy entire detail setting of PID monitor

#### [Sequence]

Select detail setting window grid to copy and select [Setting Copy] by right button of mouse.  
If you execute Setting Copy, all setting area is selected.

### 4) Setting Paste

It is used to paste all detail setting of PID monitor

#### [Sequence]

Select detail setting window grid to copy and select [Setting Copy] by pushing right button of mouse.  
Select detail setting window grid to copy and select [Setting Paste] by pushing right button of mouse.

### Note

When you select cell more than one, you can't execute Setting Copy/Paste

### 5) Initialize setting

It is used to initialize entire detail setting value of activated PID monitor. You can't use this during monitoring

#### [Sequence]

Push [Initialize] at activated loop or select [Initialize setting] on detail setting grid by pushing right button of mouse

### Note

You can't execute [Cell Paste], [Setting Paste], [Initialize Setting] during monitoring

# Chapter 12 Debugging

## 12.1 Start/Stop Debugging

### 12.1.1 Start Debugging

[Sequence]

1. Select [Online]-[Connect] on the menu to connect with PLC.
2. Select [Online]-[Write] on the menu to download the program onto PLC.
3. Select [Online]-[Change Mode]-[Debug] or [Debug]-[Start/Stop Debugging] on the menu.

#### Notes

- This function is available only with PLC connected in online
- Debug is unavailable if PLC operation is in Run mode.
- Debug function is available with XG5000 program and PLC program identical to each other. If they are not identical, download the applicable program.
- Monitoring function is also available in Debug mode.
- If any error occurs on PLC, Debug instruction will not work normally. Clear the error to execute the Debug instruction.

### 12.1.2 Stop Debugging

[Sequence]

1. Select [Online]-[Change Mode]-[Stop] or [Debug]-[Start/Stop Debugging] on the menu.
2. PLC will end Debug and come to the Stop mode.

#### Notes

- Even if Debug stops, Monitor does not end.

### 12.2 LD Program Debugging

It is used to specify functions to debug the prepared LD program.

#### 12.2.1 Set/Remove Breakpoints

It is used to set or remove the Breakpoint per step.

##### 1) Set Breakpoint

[Step]

1. Move the Breakpoint to the step to specify.

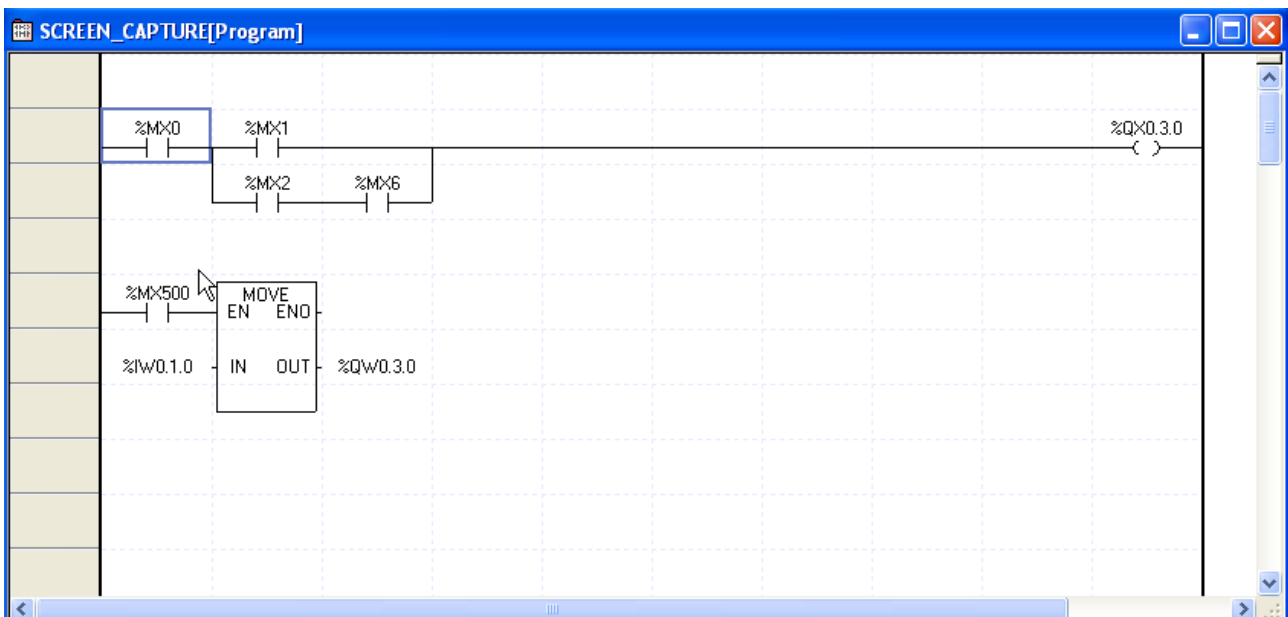

## Chapter 12 Debugging

2. Select [Debug]-[Set/Remove Breakpoints] on the menu.

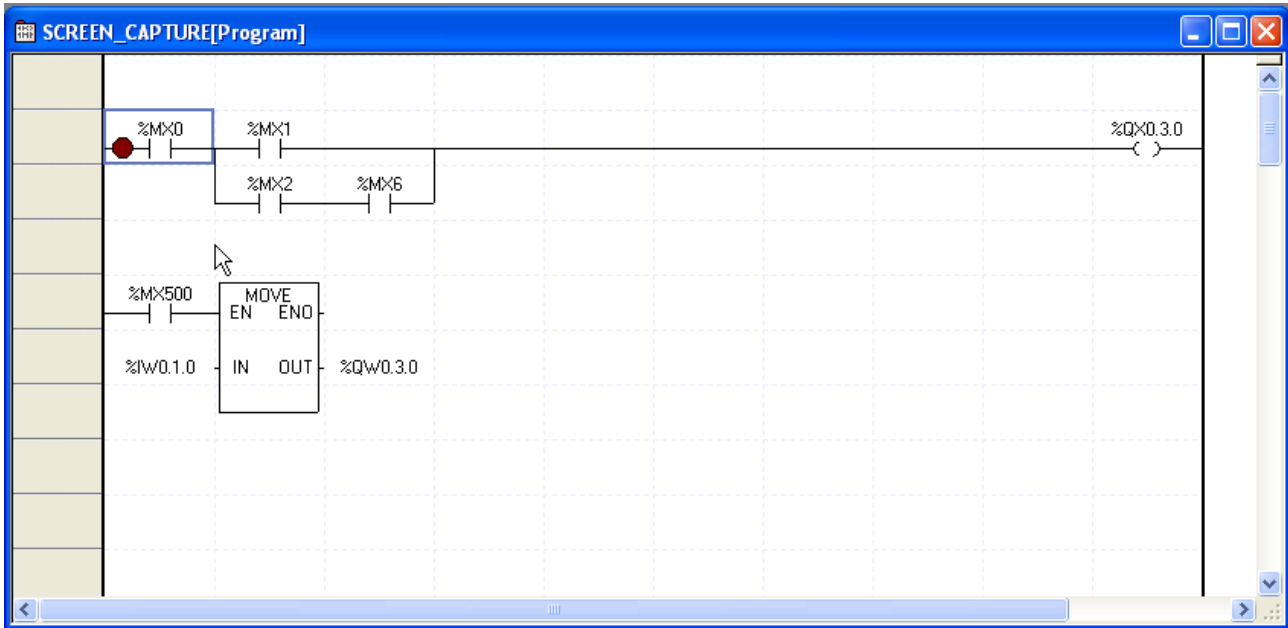

### Notes

- The break can not be set on the area specified by a Block Mask instruction.
- Application instruction will set the breakpoint on the instruction String area.

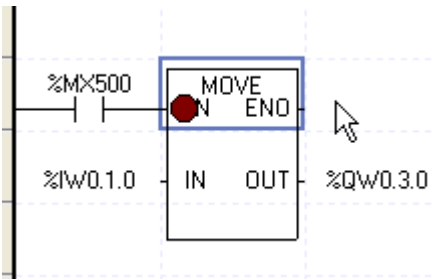

## Chapter 12 Debugging

### 2) Remove Breakpoint

[Steps]

1. Move the Breakpoint to the step to remove.

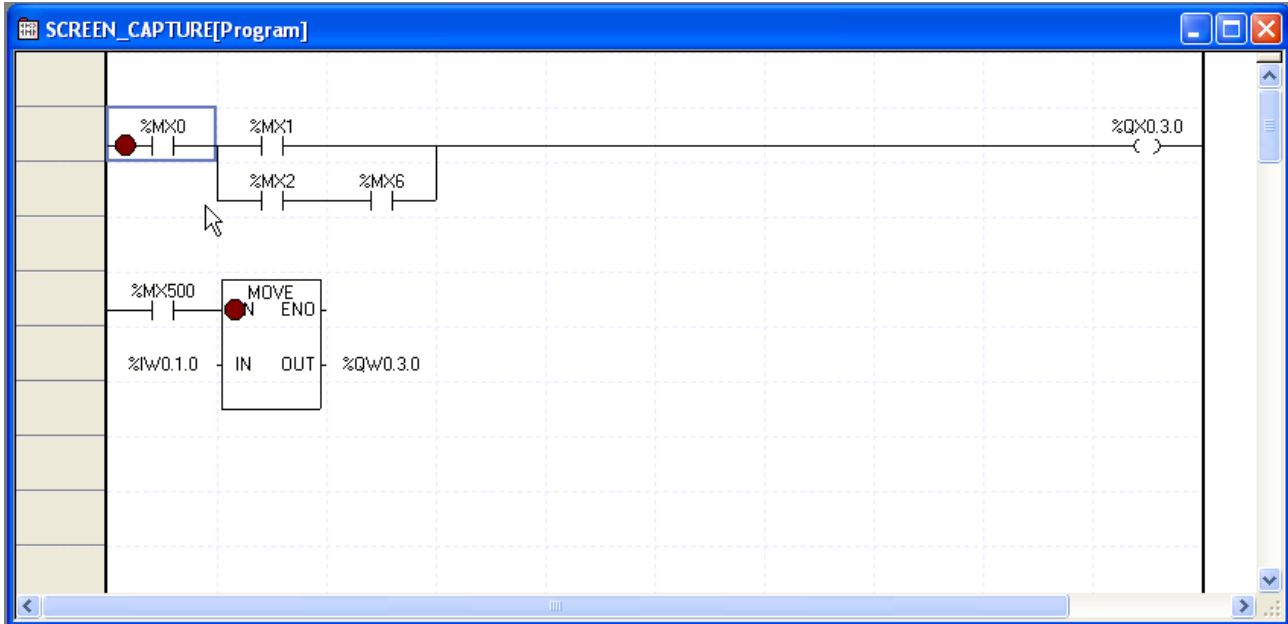

2. Select [Debug]-[Set/Remove Breakpoints] on the menu.

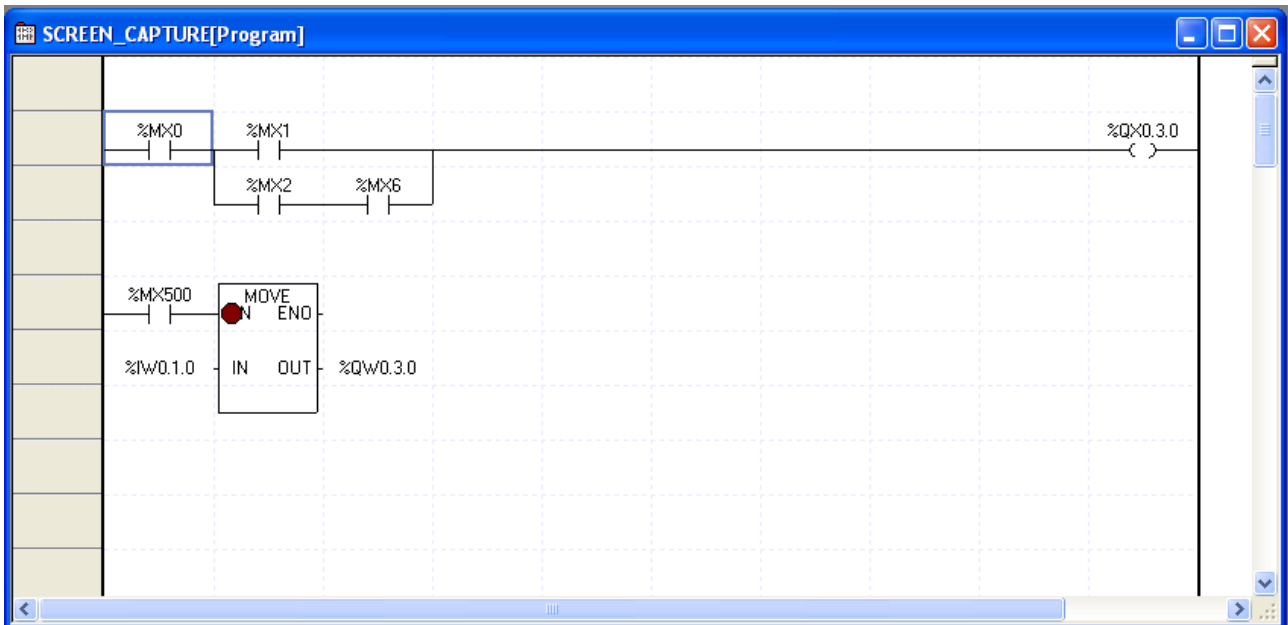

## Chapter 12 Debugging

### 12.2.2 Go

It starts program debugging using the specified Breakpoint. With the Go function, the program can be run up to the Breakpoint specified.

[Sequence]

1. Select [Debug]-[Go] on the menu. The program will be run till the breakpoint complying with the condition is reached.

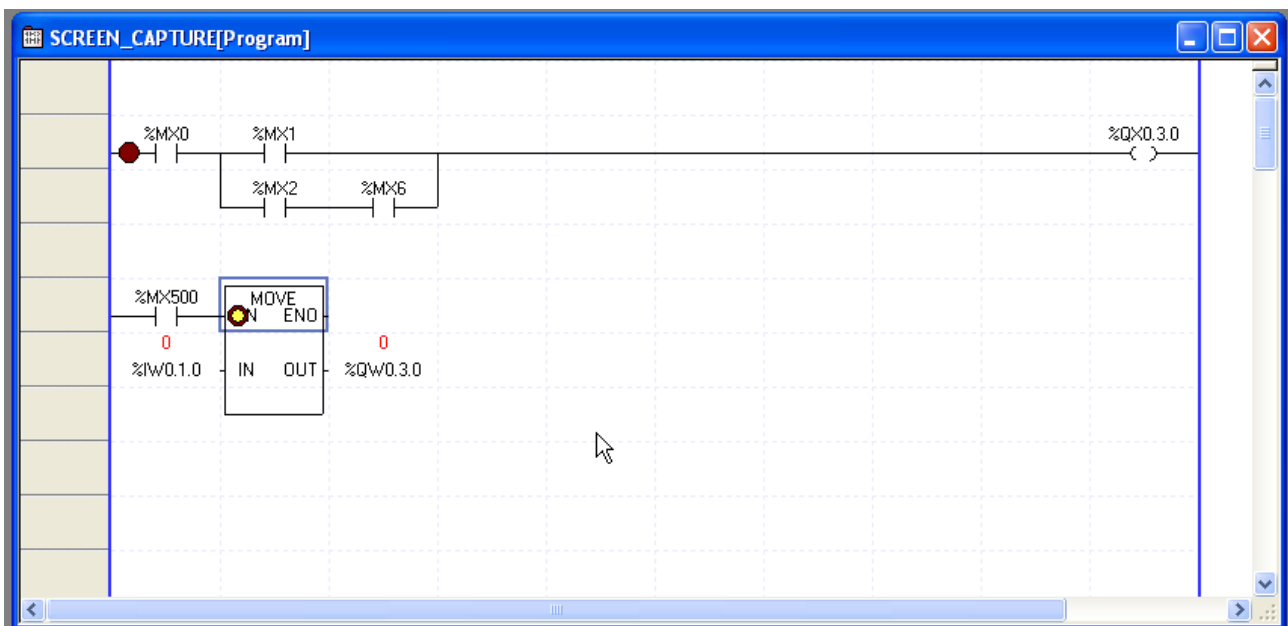
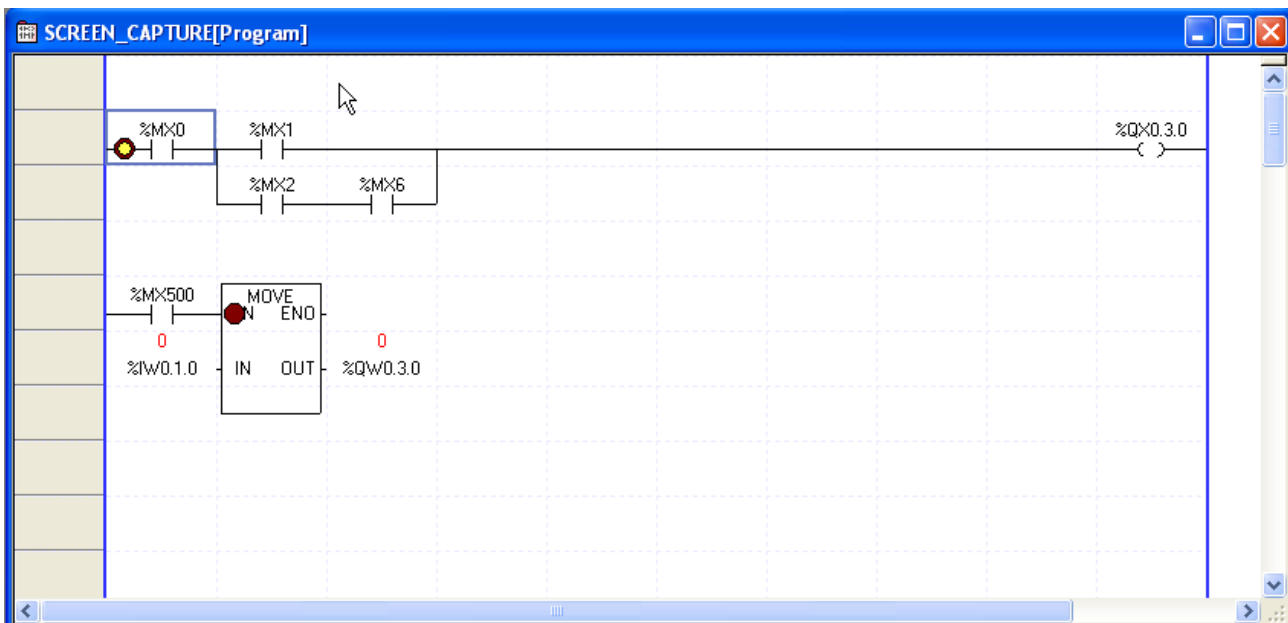

## Chapter 12 Debugging

2. Select [Debug]-[Go] on the menu again to go to the next Breakpoint.

### 12.2.3 Go to Cursor

It is used to make the program run up to the cursor position.

[Sequence]

1. Move the cursor to the position desired to run.

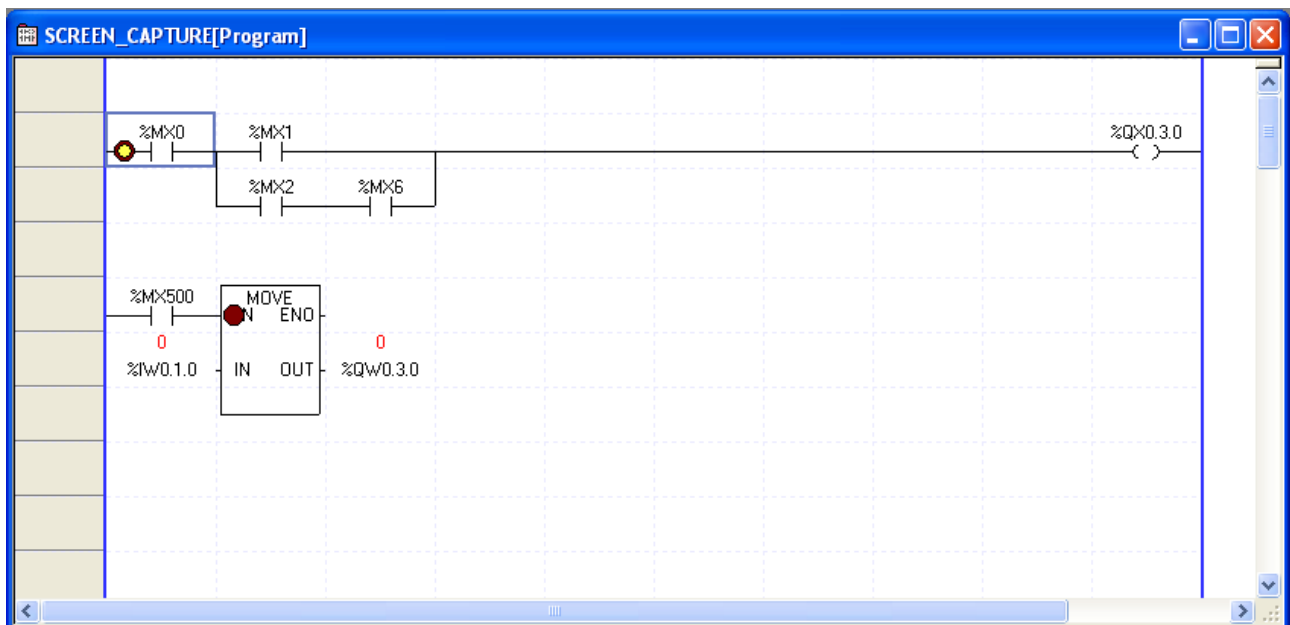

## Chapter 12 Debugging

2. Select [Debug]-[Go to the Cursor] on the menu.

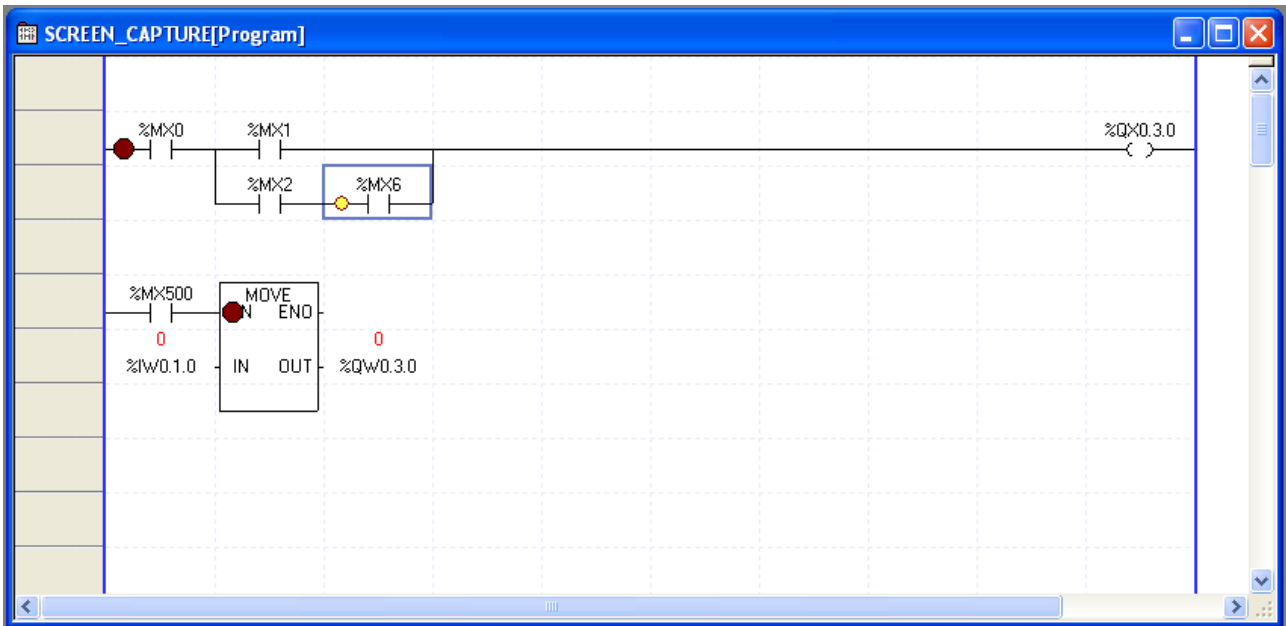

### 12.2.4 Step Into

If the Breakpoint is engaged during debugging, its progress will be made step by step. When debugging program, Step Into, Step Out and Step Out functions will be provided.

#### 1) Step Into

It runs the program to the next step. If the present step is a application instruction CALL with the running condition satisfied, it will enter the subroutine block.

[Sequence]



## Chapter 12 Debugging

1. Select [Debug]-[Step Into] on the menu.

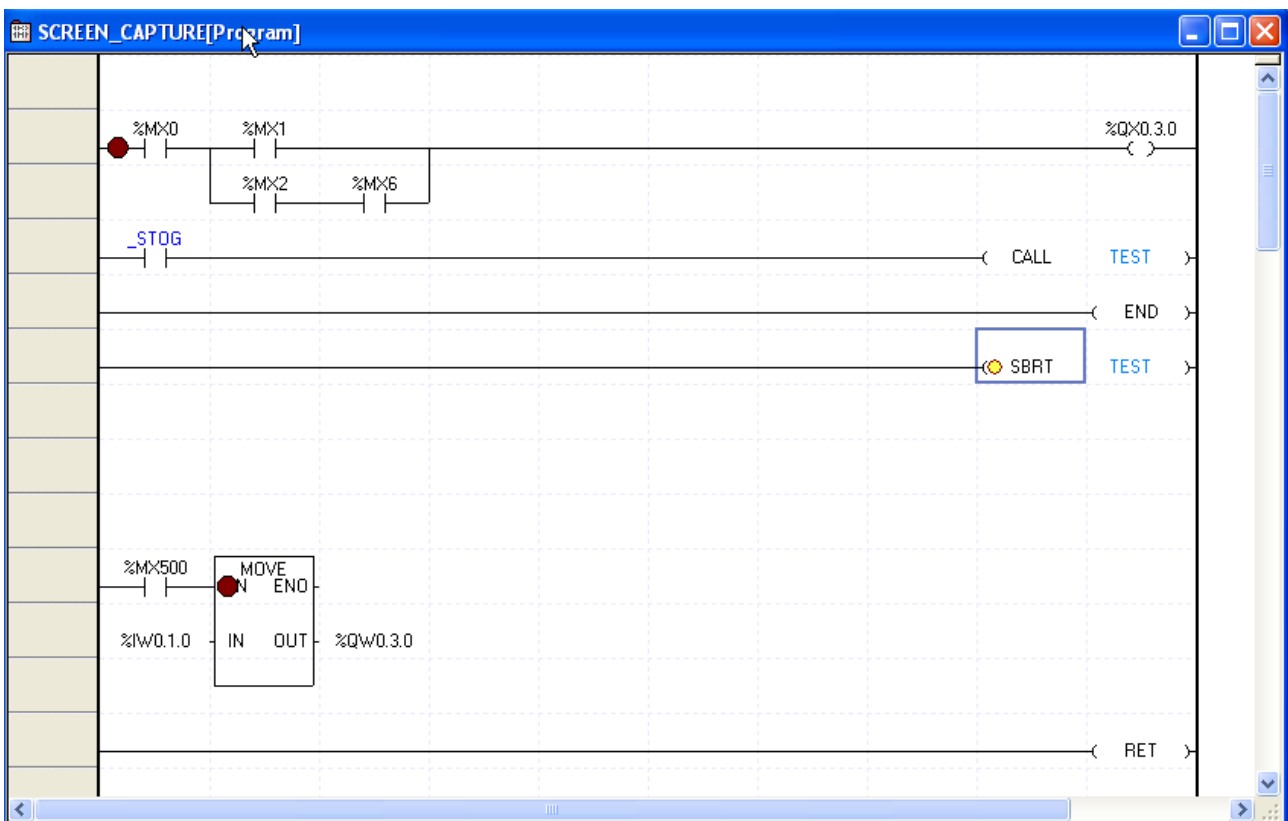
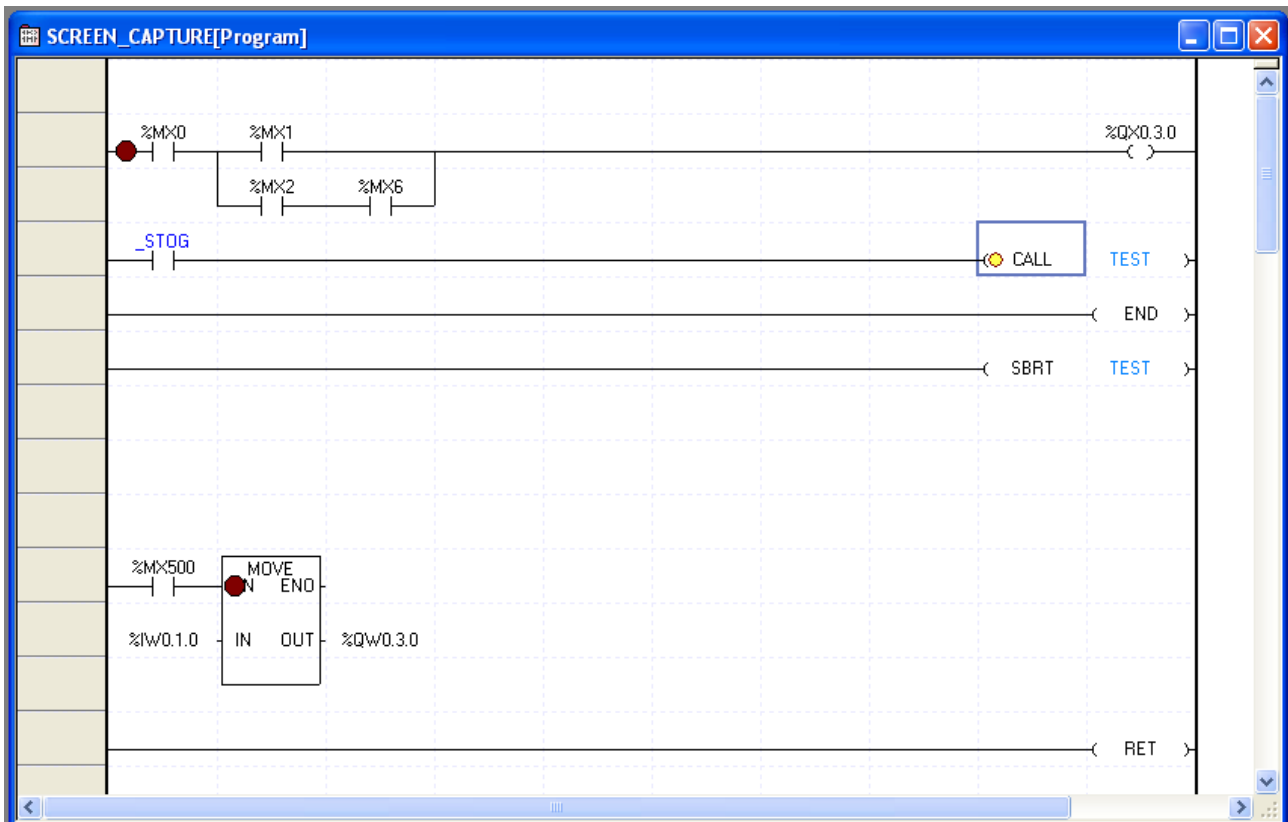

## Chapter 12 Debugging

### Notes

- If not with CALL instruction or if the CALL running condition unsatisfied, the program will be run to the next step.

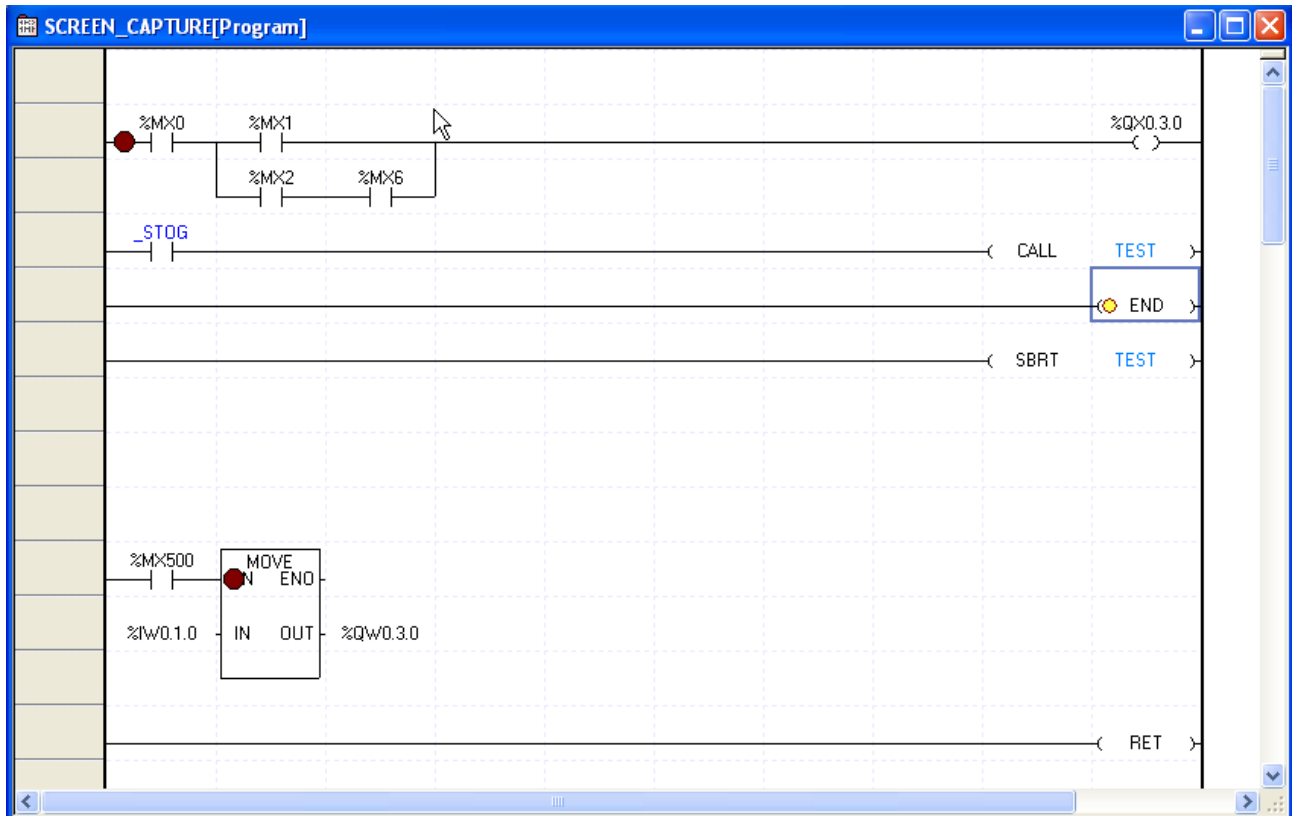

### 2) Step Out

It is used to step out of the subroutine block once entered with Step Into function executed.

## Chapter 12 Debugging

[Sequence]

1. Select [Debug]-[Step Out] on the menu.

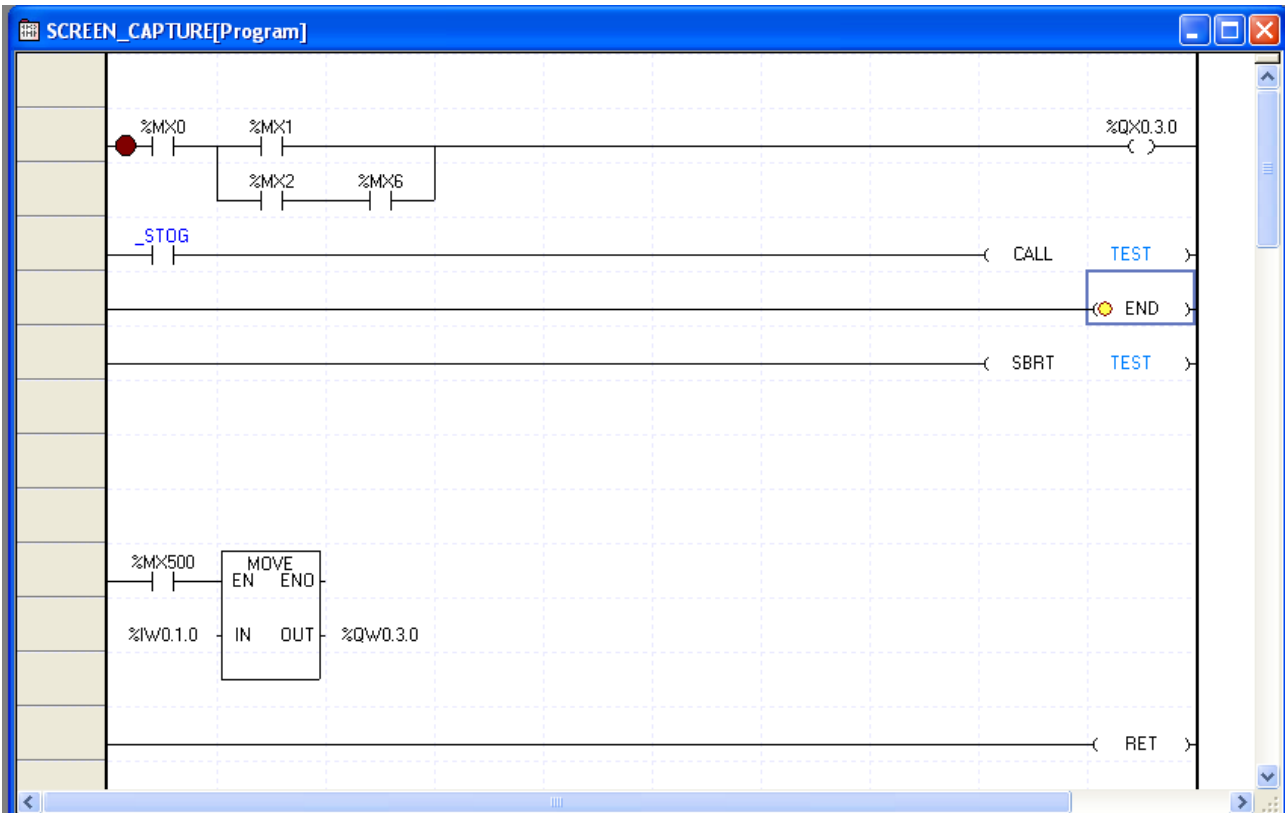
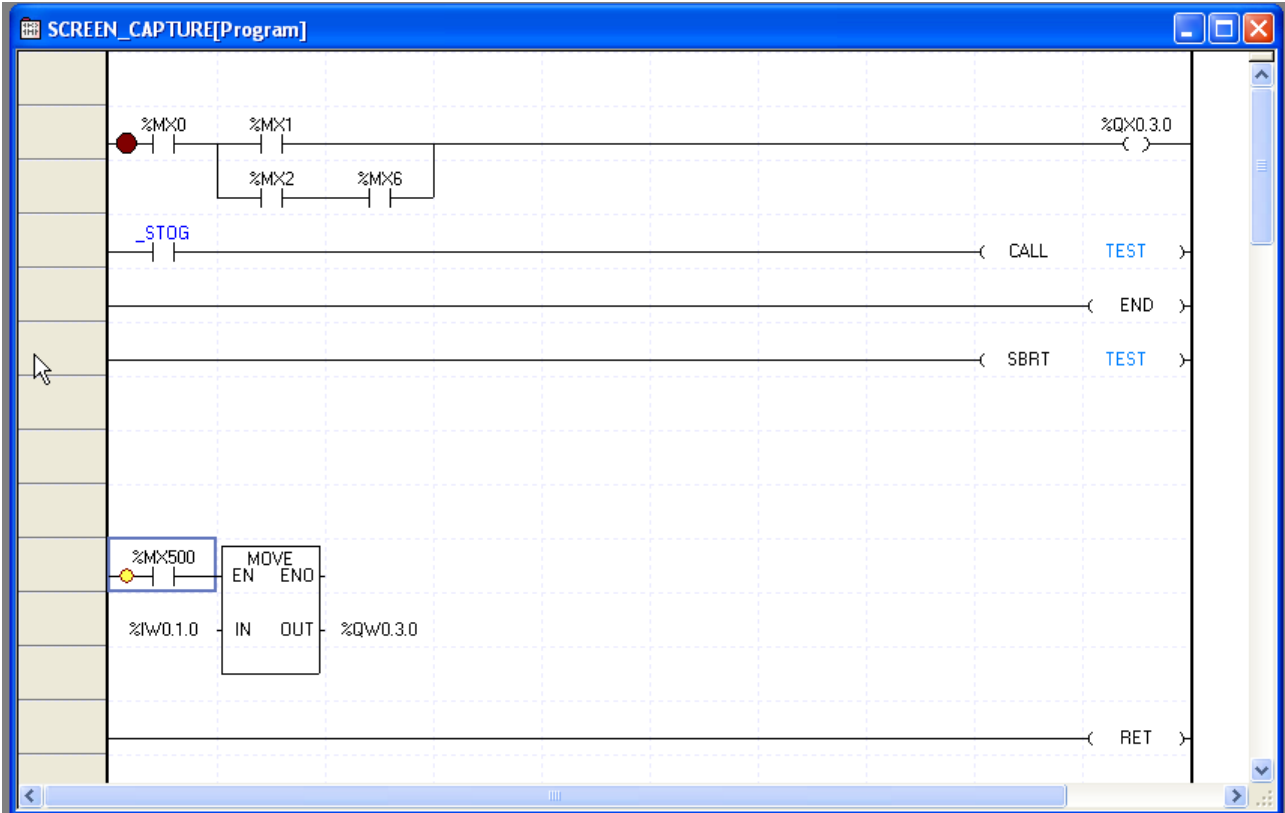

## Chapter 12 Debugging

### Notes

-If the presently debugged step is not inside the subroutine block, the program will be run to the next step.

### 3) Step Over

It is used to run the program to the next step. Differently from Step Into, even if the present step is a application instruction CALL, it will not enter the subroutine block but run the program to the next step.

[Sequence]

1. Select [Debug]-[Step Over] on the menu.

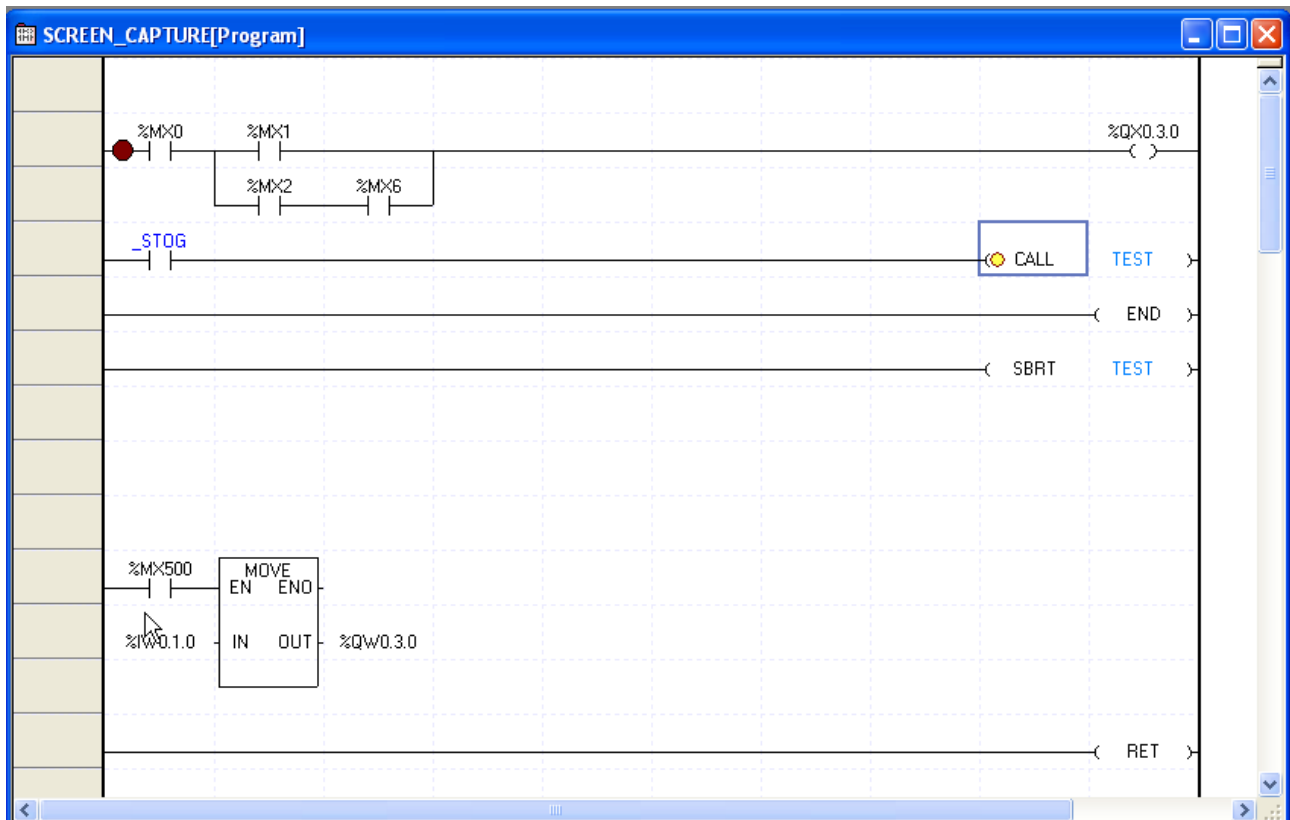

## Chapter 12 Debugging

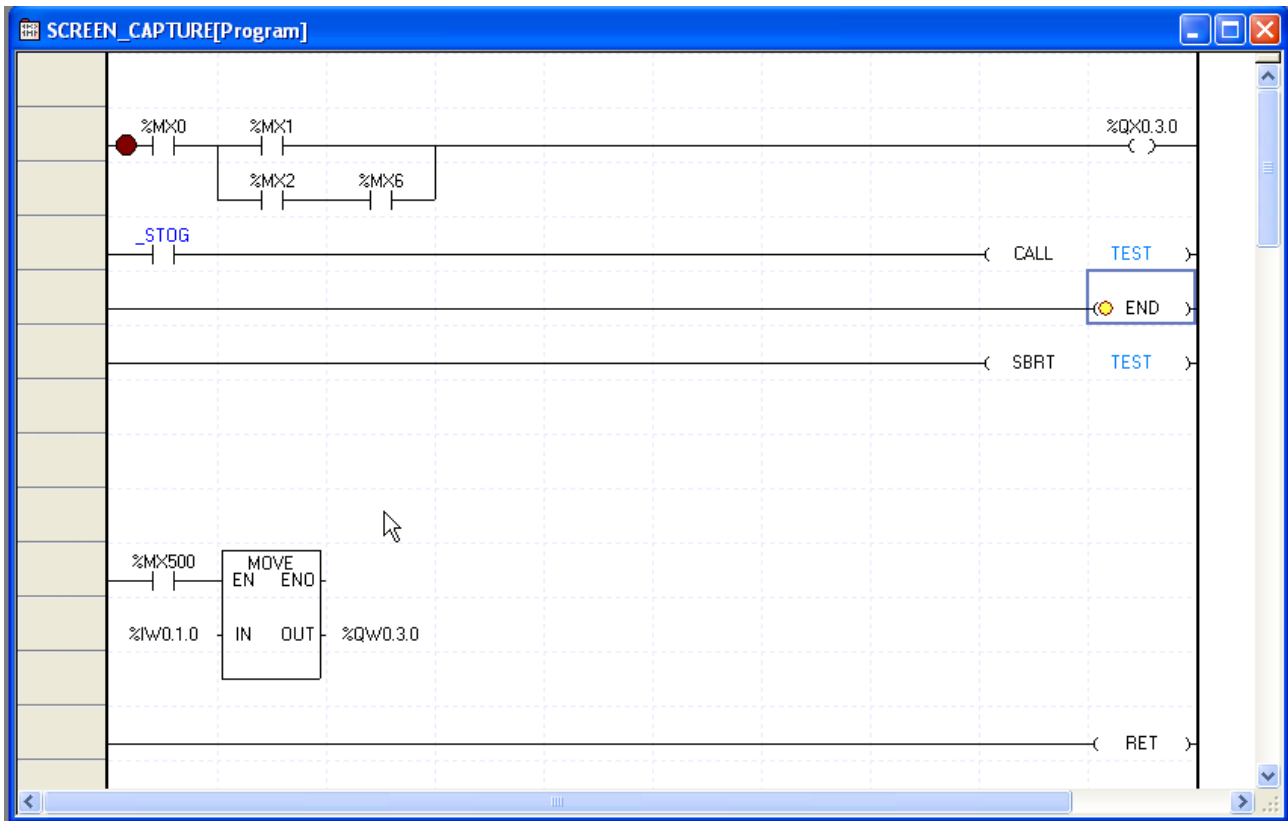

### 12.3 List of Break Points

The list shows all the Break Points being used in the program, where the user can decide to use or delete the Break Point.

[Sequence]

1. Select [Debug] - [Breakpoints List] on the menu.

[Dialog Box]

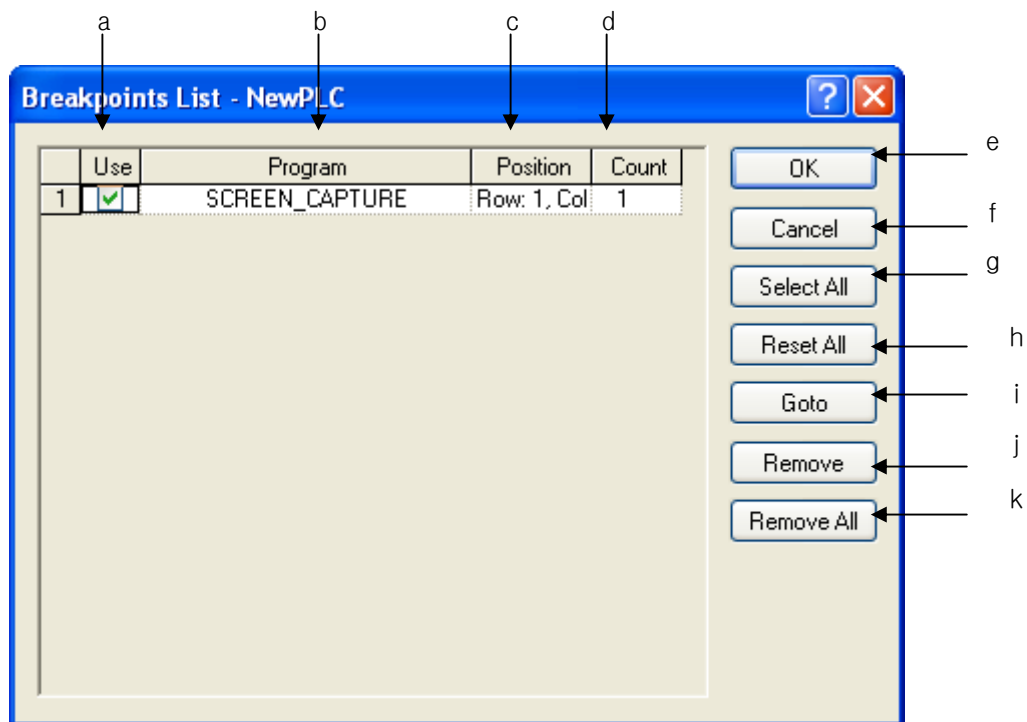

[Description of Dialog Box]

- a. Use: If the checked item once allowed is cancelled in the check box, the break only will not be engaged although the breakpoint being used is not deleted.
- b. Program: displays the name of the program where the breakpoint is used.
- c. Step: displays the Step number where the breakpoint is caught.
- d. Count: After executed the number of times as many as the specified steps where the breakpoint is caught, PLC will be then broken. (*Example*; If the breakpoint is set inside FOR 20 ~ NEXT with the number of times 10, FOR 20 ~NEXT will be executed 10 times and then will be broken.)
- e. OK: saves the changed details and closes the dialog box.
- f. Cancel: just closes the dialog box without saving the changed details.

## Chapter 12 Debugging

---

- g. Select All: checks all the listed items to allow.
- h. Reset: cancels all the checked items previously allowed.
- i. Go to: used to move to the position where the selected breakpoint is used.
- j. Remove: deletes the selected breakpoints from the list.
- k. Remove All: deletes all the breakpoints from the list.

### Notes

- Up to 62 Breakpoints are available to be registered in PLC.

## 12.4 Variable Break

Applicable debugging is available based on the data value and the application of the variable.

### 1) Setting Variable Break

[Sequence]

1. Select [Debug] - [Breakpoint Conditions] - [Variable Break point] on the menu.

[Dialog Box]

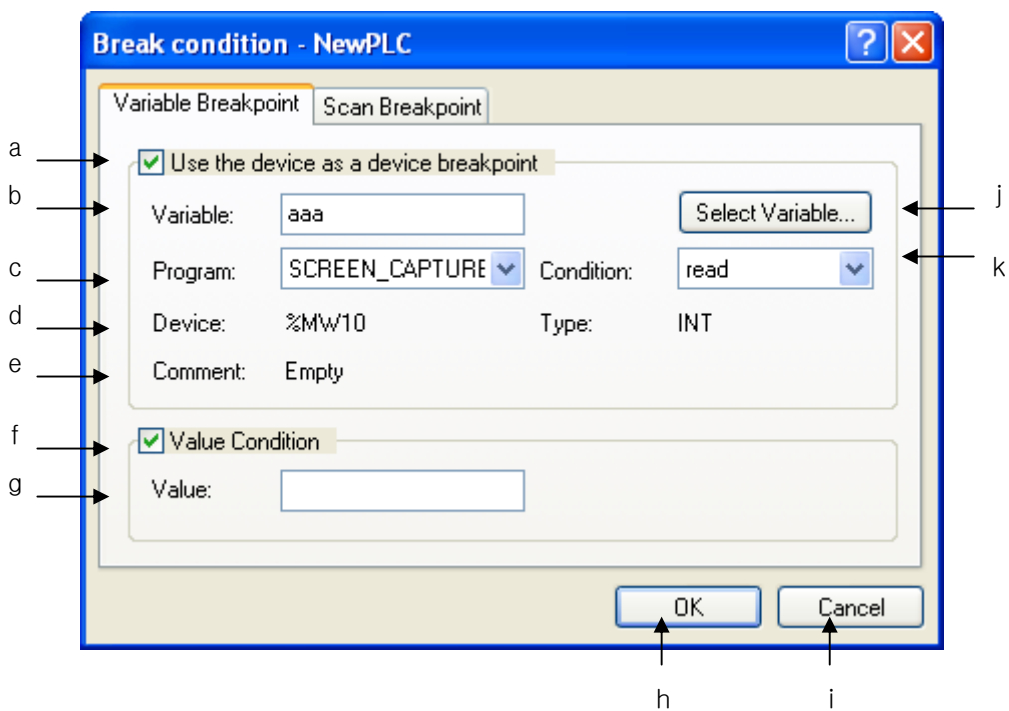



## Chapter 12 Debugging

[Description of Dialog Box]

- a. Use the device as a variable break point: If the check in the box is cancelled, the variable break even if saved, will not be used.
- b. Variable: shows the variable name used for variable break.
- c. Program: shows the program name of the variable used for variable break.
- d. Device: displays the device name if the variable's memory is allocated in the local variable.
- e. Comment: displays the comment if the variable's comment is declared in the local variable.
- f. Value Condition: If the check in the box is cancelled, the value even if saved, will not make the value break engaged.
- g. Value: if the specified device value is reached, the break will be engaged. The maximum/minimum value is based on the variable type.
- h. OK: saves the changed details and closes the dialog box.
- i. Cancel: just closes the dialog box without saving the changed details.
- j. Select Variable: finds a desired variable on the Variable list.
- k. Condition: makes the break engaged when writing the value on or reading the value from device.

### 2) Variable Break Run

[Sequence]

1. Specify the variable break.
2. Select [Debug]-[Go] on the menu. PLC runs debugging.
3. If specified variable break conditions are met, a message will be displayed to inform that the variable break is engaged, when PLC stops running.

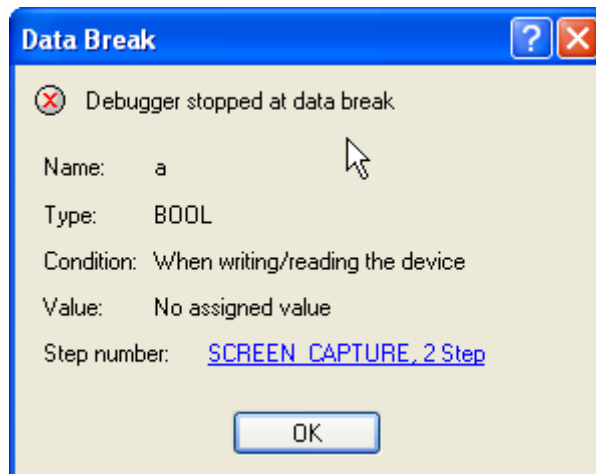

### Notes

- a. Among variable types, BYTE, NIBBLE and STRING do not support the variable break instruction.
- b. While PLC runs debugging, just one condition if only satisfied among breakpoint, variable break, scan break, etc., will apply the break.
- c. Click the left mouse button on the program name to move to the program position where the variable break is applied.
- d. If the value is changed in other application programs (such as device monitor) than the specified program, movement to the program position where the variable break is applied may not be possible.

### 12.5 Scan Break

This function is used to run PLC as many as the scan times specified, and apply the break.

[Sequence]

1. Select [Debug] - [Break Conditions] on the menu.
2. Select [Scan Break point] tap.

[Dialog Box]

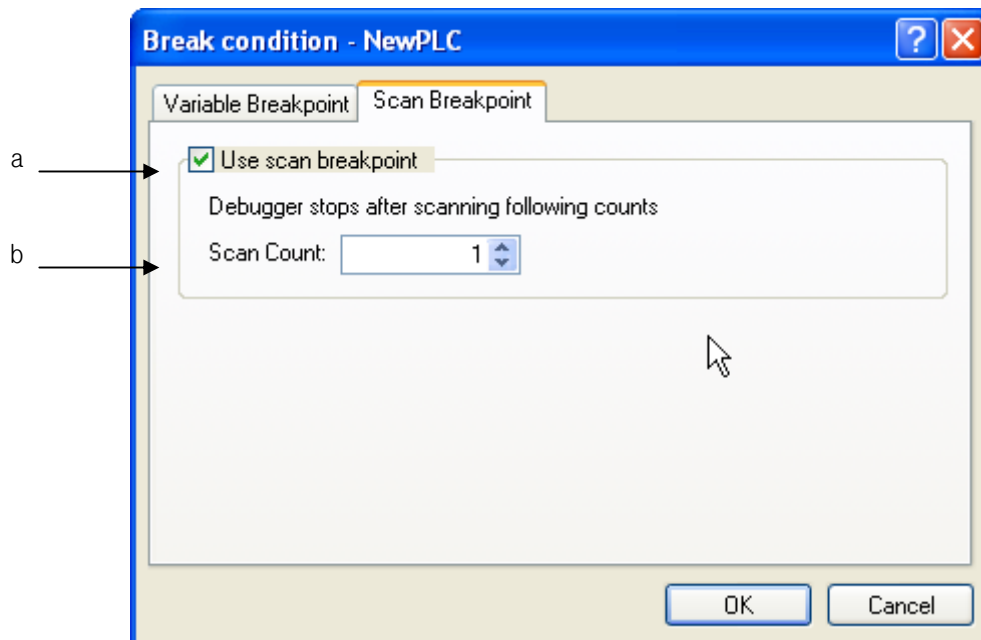

[Description of Dialog Box]

- a. Use Scan Break point: If the check in the box is cancelled, the specified scan break times even if saved, will not be executed while PLC runs debugging.
- b. Scan Count: used to input scan times to apply the break. 1 ~ 2147483647 is available for the setting value.

[Scan Break Run]

1. Check Use Scan Break and specify the scan times to apply the break.
2. If [Debug]-[Go] is selected on the menu, PLC runs debugging.
3. PLC will inform that the scan break is engaged after executed as many as specified scan times.

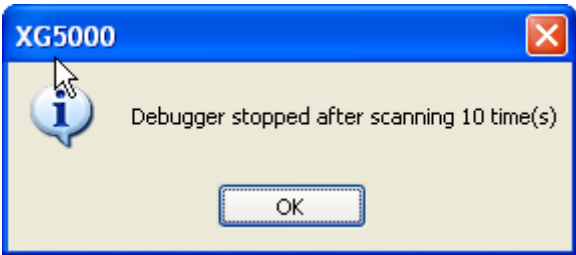

## Chapter 13 Online Editing

This function is used to edit the PLC program with PLC operation status in Run mode.

### 13.1 Sequence of Online Editing

#### 13.1.1 Sequence of Online Editing

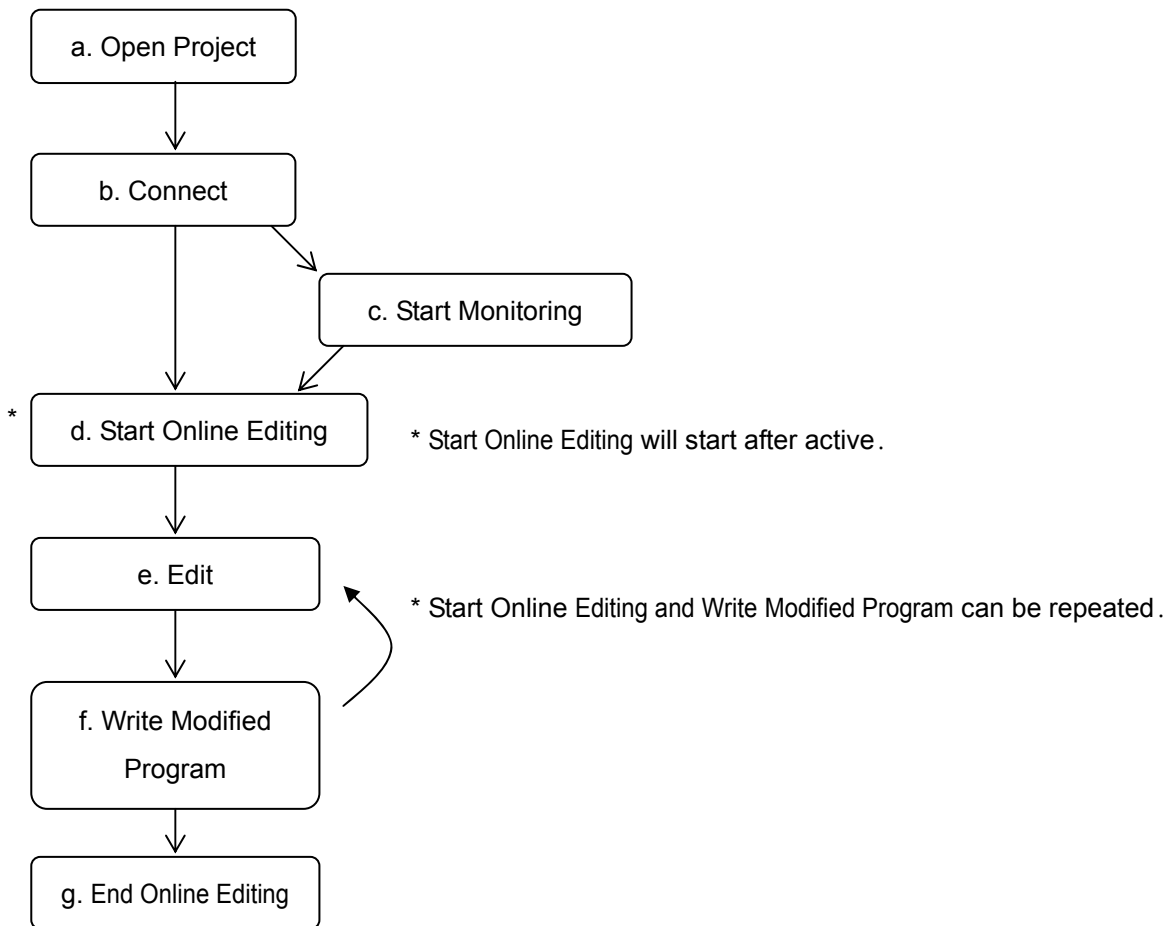

[Description of Sequence]

**a.** Open Project

- Select [Project]-[Open Project] on the menu. Open the project identical to the PLC project to perform Online Editing. Select [Project]-[Open from PLC] on the menu.

## Chapter 13 Online Editing

### b. Connect

- Select [Online]-[Connect] on the menu to connect with PLC.

### c. Start Monitoring

- Select [Monitor]-[Start Monitoring] on the menu.
- Online Editing is available while monitoring.
- Start/Stop Monitoring is available during Online Editing.

### d. Start Online Editing

- Select [Online]-[Start Online Editing] on the menu.
- Online Editing will be available after its program window is active and the program is selected.
- After Program or Variable is edited during Run, the program window will be changed to edit mode during Run

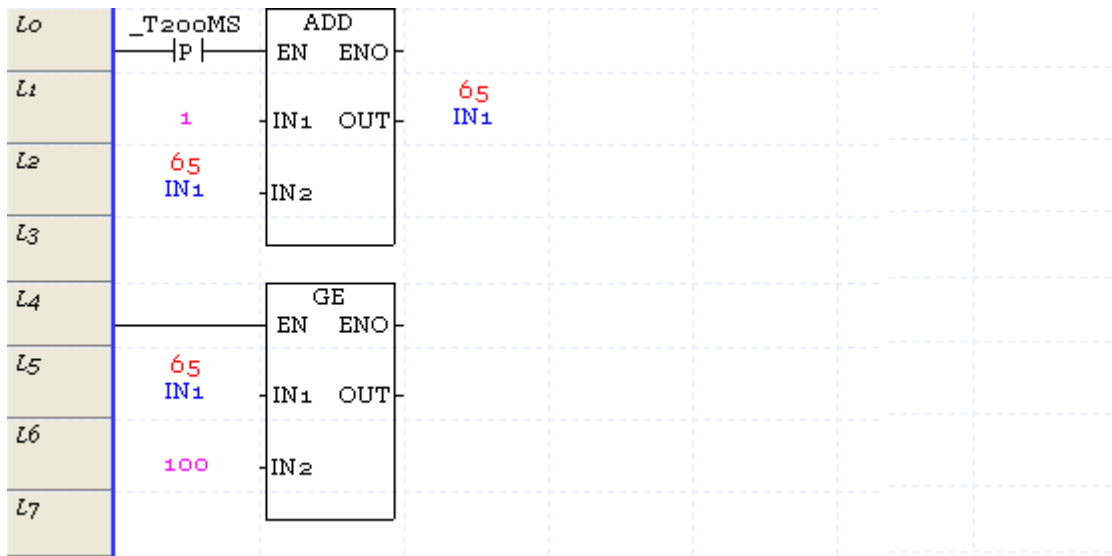

## Chapter 13 Online Editing

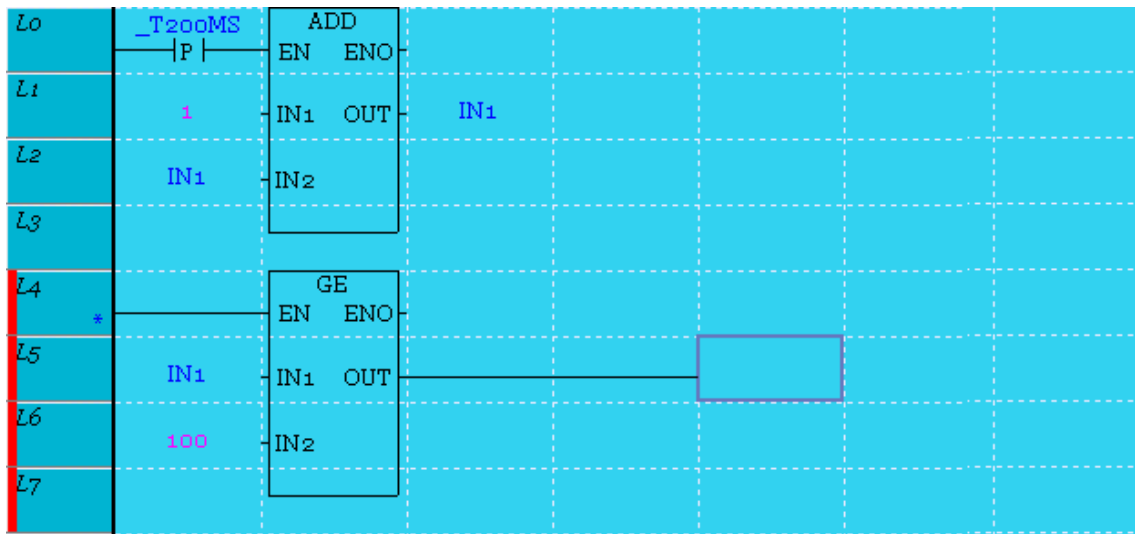

- If Online Editing starts, the background color of the program can be changed through its applicable option.

### e. Edit

- Edit Online Editing is the same as specified in the off-line Edit.
- In case of the LD, the edited rung is indicated with (\*).

### f. Write Modified Program

- Select [Online]-[Write Modified Program] on the menu.
- The applicable program only will be transferred to PLC.
- In case of the LD, the edited rung is indicated with (\*).

### g. End Online Editing

- Select [Online]-[End Online Editing] on the menu.

### Notes

- Project can not be closed during Run Modify
- One or more programs can be modified during Run.
- While editing during Run, the monitoring value is not correct. The correct value can be monitored as long as modifying during Run.
- For the items to edit during Run, refer to the followings

(Edit Item means that add, delete and change are available)

Item	Description	Edit	Item	Description	Edit
Project properties	Add	X	User defined function/function block	Add	○
	Delete	X		Delete	X
	Change	X		Change	X
Program	Add	X	LD	Edit	○
	Delete	X	IL	Edit	X
	Change	○	SFC	Edit	X
Global variable	Add	○	SFC action (LD)	Add	X
	Delete	X		Delete	X
	Change	X		Change	○
Local variable	Add	○	SFC Transition (LD)	Add	X
	Delete	○		Delete	X
	Change	○		Change	○
User-defined type	Add	○	Parameter change	Edit	X
	Delete	X	Local variable retain setting	Edit	○
	Change	X	Global variable retain setting	Edit	X



## Chapter 14 Print

### 14.1 Print Project

This instruction is used to print all the contents in the project in regular sequence.

It is also used to select items to be printed, specify necessary setting options for printing per item, and execute Preview and Print instruction.

[Steps]

1. Select [Project]-[Print Project] on the menu.
2. Print Project dialog box will appear.
3. Specify each item.

[Dialog Box]

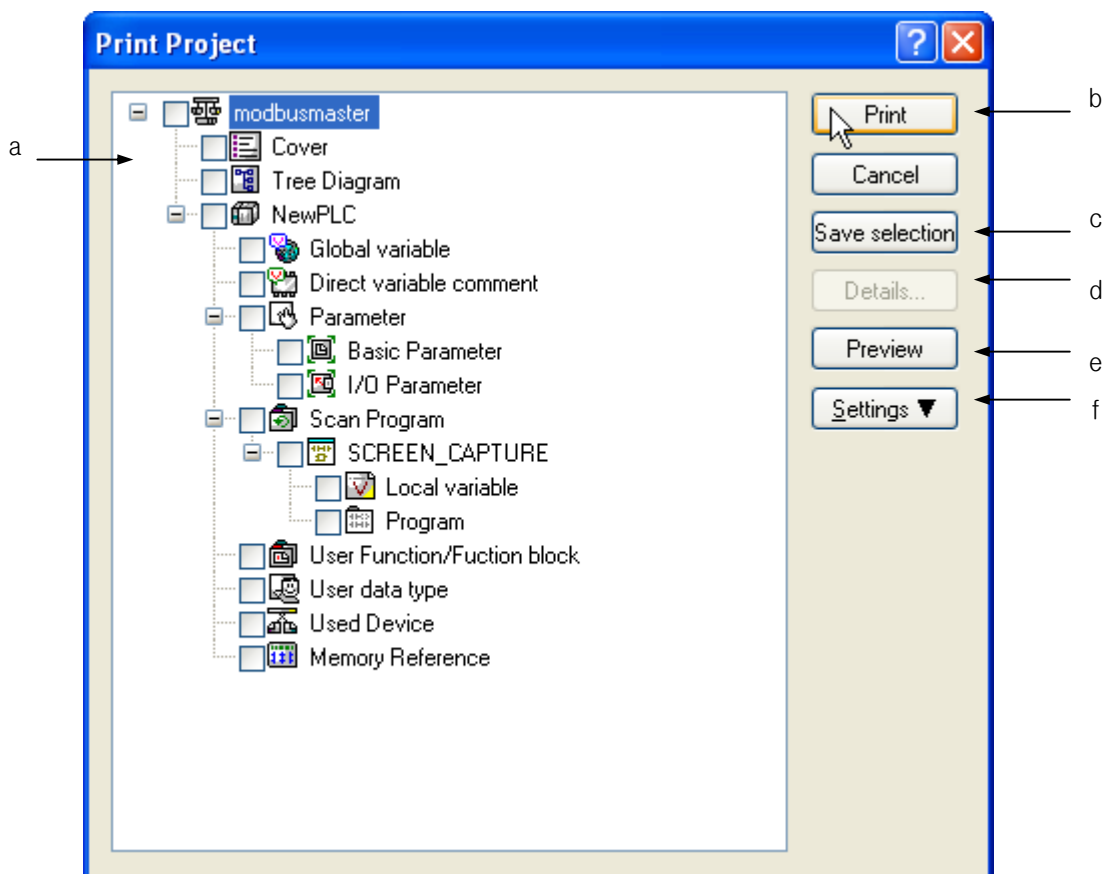

## Chapter 14 Print

[Description of Dialog Box]

- a. Project Level Diagram: displays level structure of the item printable in the Project. Detailed setting functions are available in the tree structure of the Level Diagram. Print and Previous View functions are available for the selected item.
- b. Print: prints the selected item in the Project Level Diagram.
- c. Save Selection Item: saves the selected item in the Project Level Diagram.
- d. Details: used to specify details of the selected item in the Project Level Diagram.
- e. Preview: used to view the selected item previously to print in the Project Level Diagram.
- f. Settings: sets the general print options such as Printer Setting, Print Page Setting, Margin Setting, etc.

### Notes

- Details button in the Project Level Diagram will be active only with the right mouse button positioned on [Cover], [Program], [I/O parameter] as selected presently.
- Refer to each print option for setting each detailed item. (Program Print Setting → Refer to Program Print)
- Device and Memory Reference used in the Project Level Diagram are identical to those on the window displayed when [View]-[Used Device] and [View]-[Cross Reference] are executed on the menu.

### 14.1.1 Print Setting

It is used to specify paper to print on and the printer.

[Steps]

Click 'f. Setting' on the main Print Dialog Box or click the right mouse button in the 'a. Project Level Diagram'.

[Dialog Box]

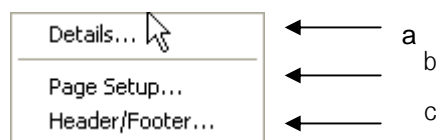

[Description of Dialog Box]

- a. Details: Refer to Print Setting for each item.
- b. Page Setting: used to specify paper to print on.
- c. Header/Footer: used to input String displayed on the Header and Footer

### 14.1.2 Page Setup

It is used to specify margins of paper to print on.

[Steps]

1. Click 'f. Setting' on the main Print Dialog Box or click the right mouse button in the 'a. Project Level Diagram'.
2. Select [Page Setup] on the menu.

[Dialog Box]

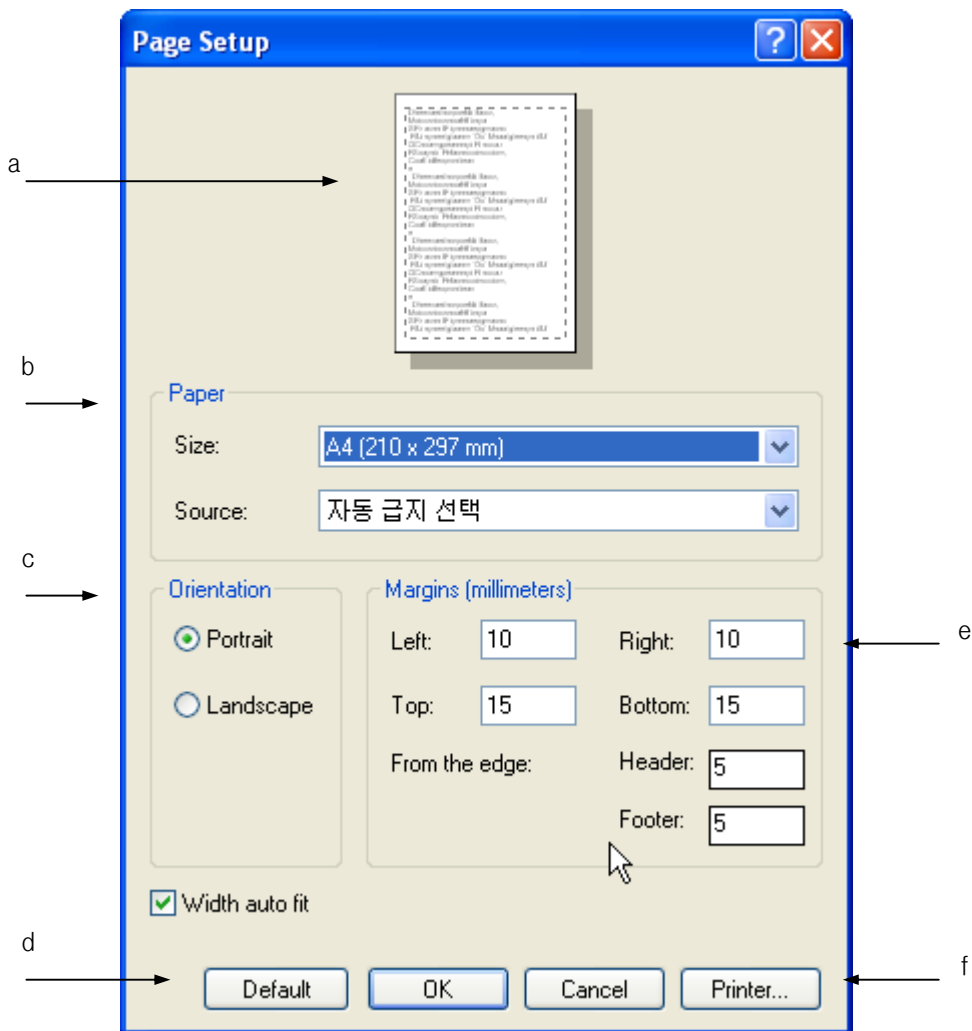

## Chapter 14 Print

[Description of Dialog Box]

- Where the selected paper and layout of margins can be viewed previously.
- Used to select paper to print on.
- Used to select a printing direction.
- Back to Default: details of Margins, Header and Footer are changed back to default, the basic value specified when the program installed
- Margin Setting: specifies margins of paper printed.
- Printer: used to change the setting options of the printer.

### Notes

- Be careful not to let the print contents overwritten with header or footer when printed, with due regard to margins.
- If there are no content in header/footer, no header/footer will be printed.

### 14.1.3 Header/Footer Setting

It is used to specify the content of Header/Footer.

[Dialog Box]

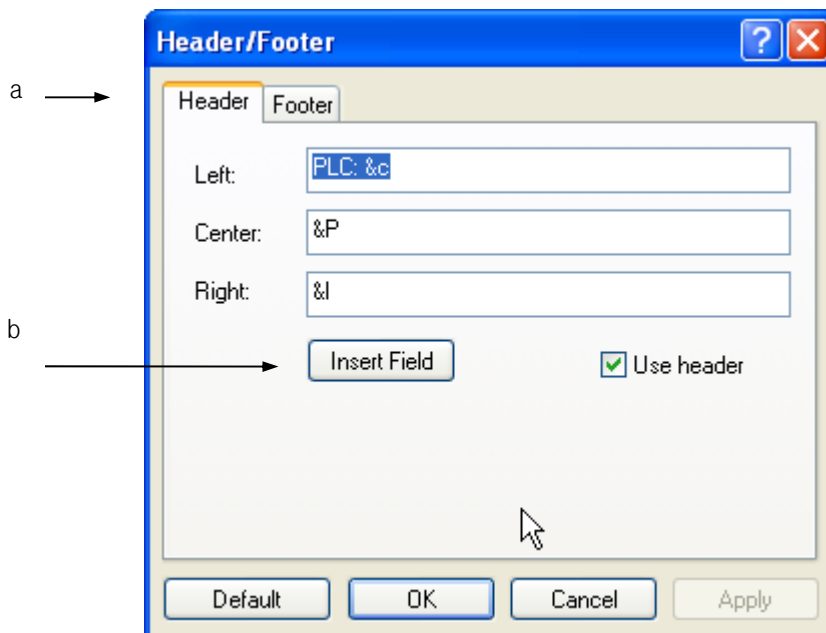

[Description of Dialog Box]

- a. Content Setting: used to input the content in the left/center/right of the Header/Footer.
- b. Insert Field: used to insert the field into the position of the cursor presently placed on the Edit Box (left, center, right)

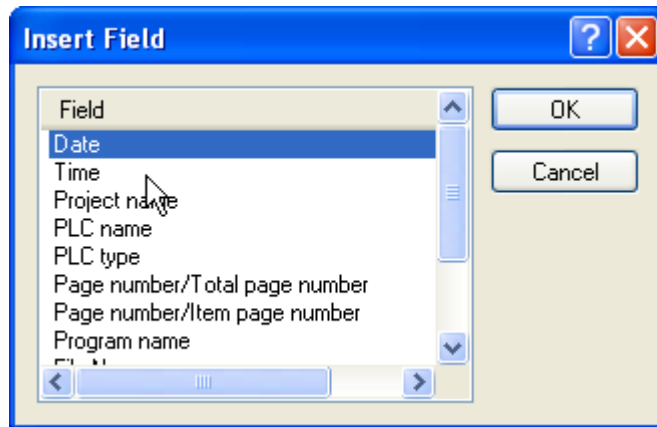

#### Notes

- If the content of the header/footer is long, the header/footer in the left, center or right may be printed as overwritten with each other.
- The user can specify the content of the header/footer using Input and Field at the same time.  
*Example)* If the content of "The date today is &d" is input on the header/footer  
→ "The date today is 2004-06-01" will be printed.
- Field Content
- Date: &d → yyyy-mm-dd
- Time: &t → hh:mm:ss
- Project name: &p
- PLC name: &c
- PLC type: &T
- Page number/Total Page number: &n → Page number/Total Page number of the selected items
- Page number/Item page number: &N → Page number/Item page number of one item
- Program name: &P → displayed only in program print mode.
- File Name: &f → file name of the present project
- Path and file name: &F → file name displayed with its directory route.
- Project comment: &C → Project comment will be printed if any. The comment if too long may not be correctly printed.

### 14.1.4 Cover Setup

It is used to specify the print cover.

[Steps]

1. Select [Cover] in the Project Level Diagram on Print Dialog Box.
2. Click Details button, or press Enter key.

[Dialog Box]

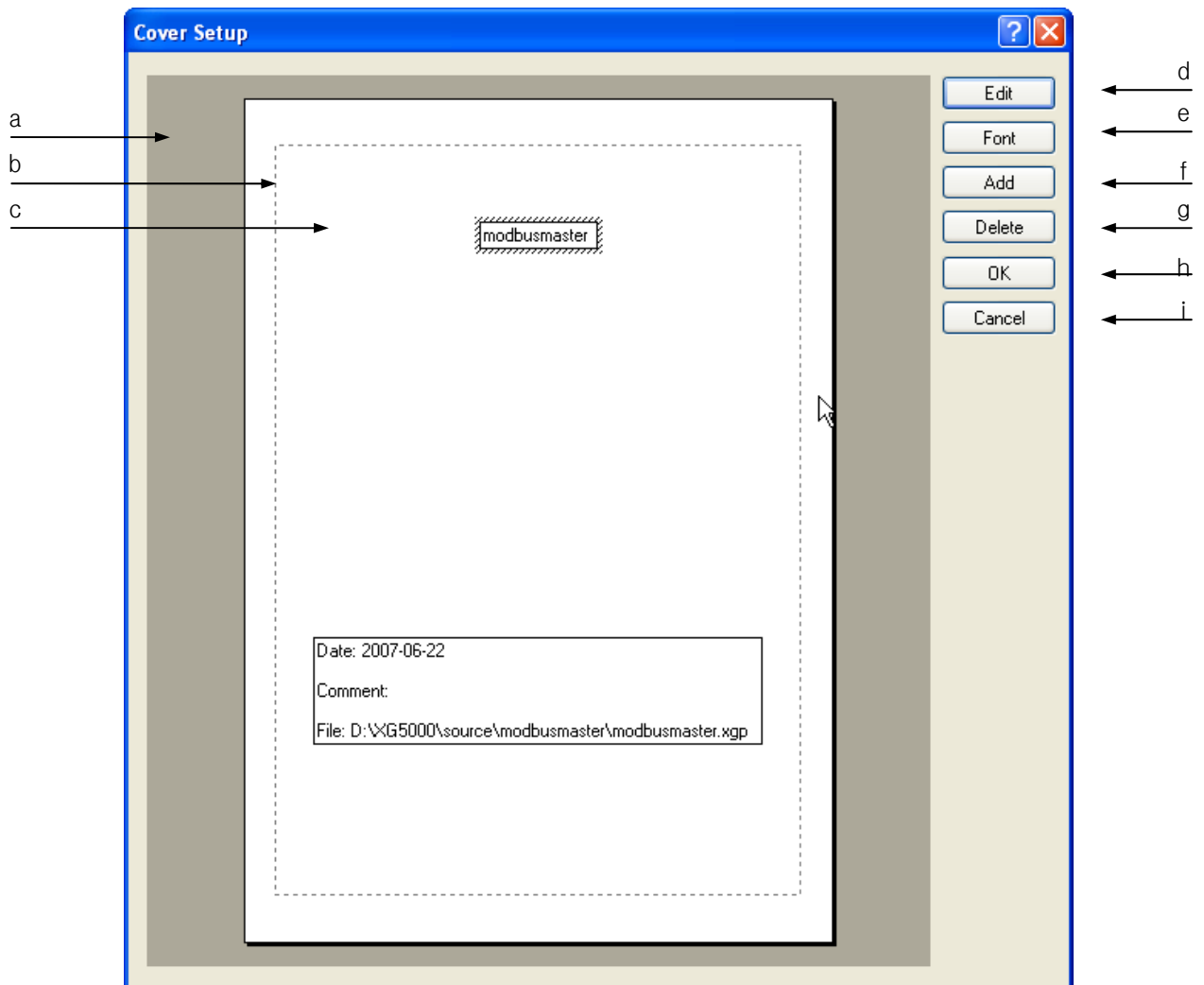

[Description of Dialog Box]

- a. Cover Paper: Default is A4 vertical. Printed differently based on the paper setup. If the Edit Box exceeds the paper, the exceeded area will not be printed.
- b. Margin Display: displays the specified margins with a dotted line.
- c. Edit Box: displays the content printed on the cover, where the content, font and position can be changed.
- d. Edit: used to edit the content of the presently selected Edit Box. Double-click the mouse on “c. Edit Box” or press Enter key when the Edit Box is selected to execute Edit. If the Field is inserted, Edit is also available.
- e. Font: changes font of the presently selected Edit Box.
- f. Add: adds a new Edit Box to the print cover.
- g. Delete: deletes the presently selected Edit Box.
- h. OK: applies the changed items and closes the dialog box.
- i. Cancel: closes the dialog box.

## Chapter 14 Print

[Content Add Steps]

1. Press [Add] button.
2. Move the mouse on the paper.
3. The mouse cursor will change as shown.
4. Click the left mouse button on the paper.
5. Edit Dialog Box will appear.

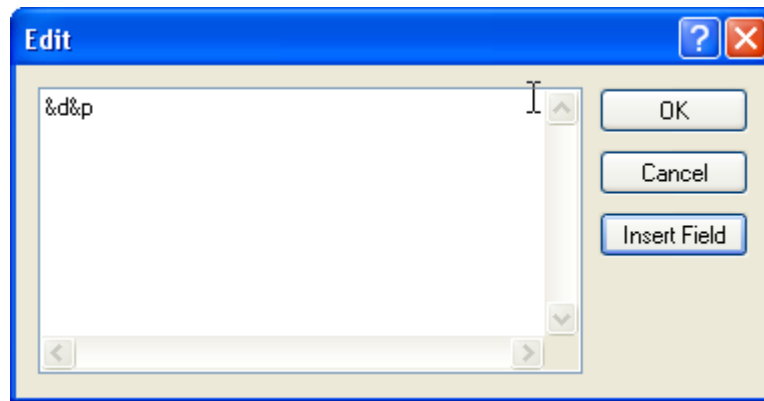

6. Pressing ESC will change the mouse cursor to the arrow shape again.



## Notes

- Edit Box can be aligned in the paper and the Edit Box.
  - It will be available through the menu displayed by the right mouse button pressed on the paper.

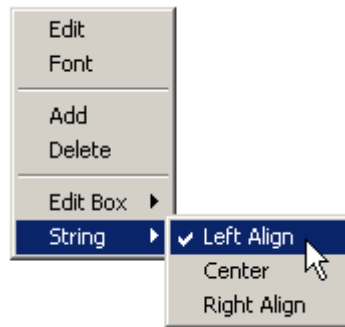

- [Edit Box]-[Center]: aligns the selected Edit Box on the center of paper.
- [String]-[Left Align]: aligns the content of the selected Edit Box on the left in the Edit Box.
- The edge of the Edit Box will not be printed.
- Edit Box can be moved by Drag and Drop instruction of the mouse or with the arrow keys.
- Undo and Redo are not available.
- If string including field is previously viewed, the field will be displayed as analyzed. If edited, the field will be displayed back.

## 14.2 LD Program Print

It is used to print the selected LD program.

### 14.2.1 Print Setting

[Steps]

1. Select the program item to print.
2. Select [Project]-[Print] on the menu .

[Dialog Box]

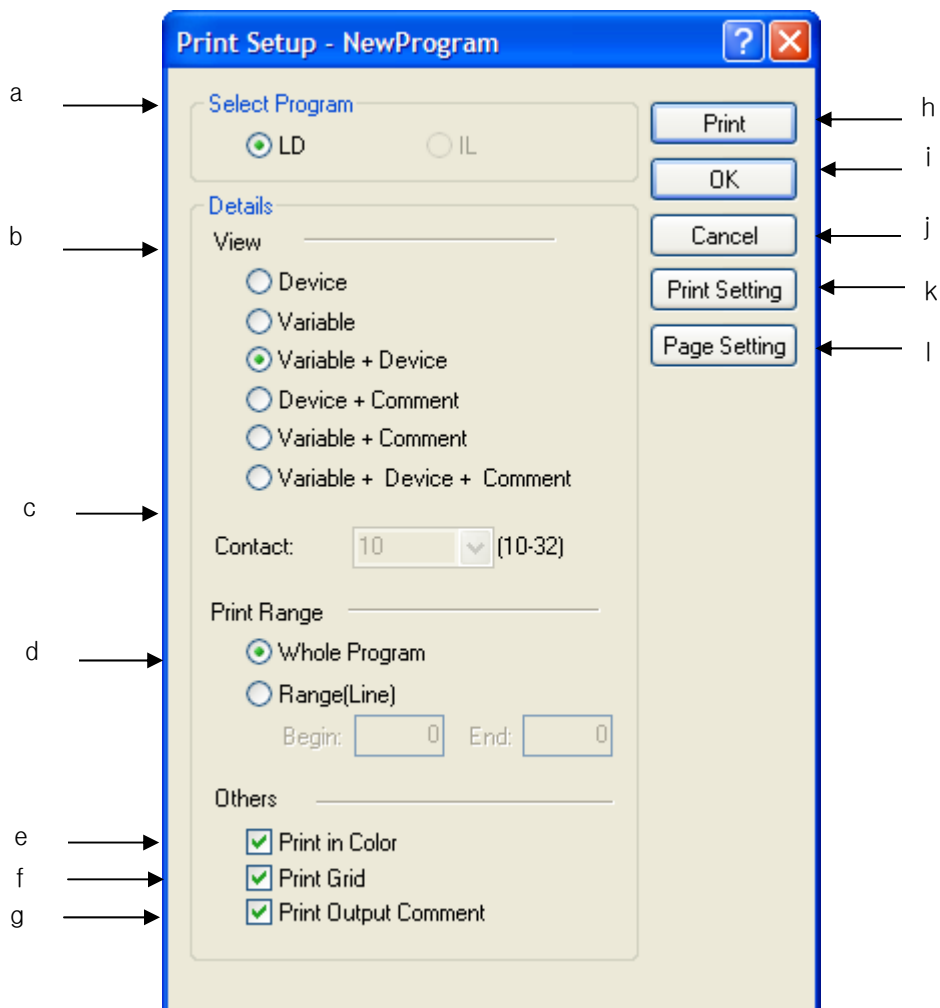

[Description of Dialog Box]

- a. Select Program: selects a program to print. In LD program, IL program print can not be selected.

### Notes

- When printing the project, click Details button after selecting the program name to set print setup.

- b. View Options: used to specify View Options for printing. Refer to 5.3 Program View Options in this manual for each View Option.
- c. Contact: used to specify the number of contacts in a line. The number of contact is fixed to the number currently displayed if printing is executed in the LD program.
- d. Print Range: specifies print range
- e. Print Color: used to decide to apply Color print or not. If the check box is selected, the print will be in color, and if not, it will be in black-and-white.
- f. Print Grid: used to decide to apply Grid Print or not.
- g. Print Output Comment: prints print comment
- h. Print: starts to print with the presently specified options applied.
- i. OK: applies the presently specified options and closes the Dialog Box.
- j. Cancel: closes the Dialog Box.
- k. Printer Setting : used to specify the printer setup options.
- l. Page Setting: used to call 'Page setup' dialog box. The size of paper and space of print page can be setup in the 'Page Setup' dialog box.

### 14.2.2 Preview

It is used to previously view the content of the print specified.

[Steps]

- 1.1. Select [Project]-[Preview] on the menu.

## Chapter 15 User Function/Function Block

A user can personally create and use a function/function block, which is not provided by XG5000. The User Function/Function Block can be created as follows.

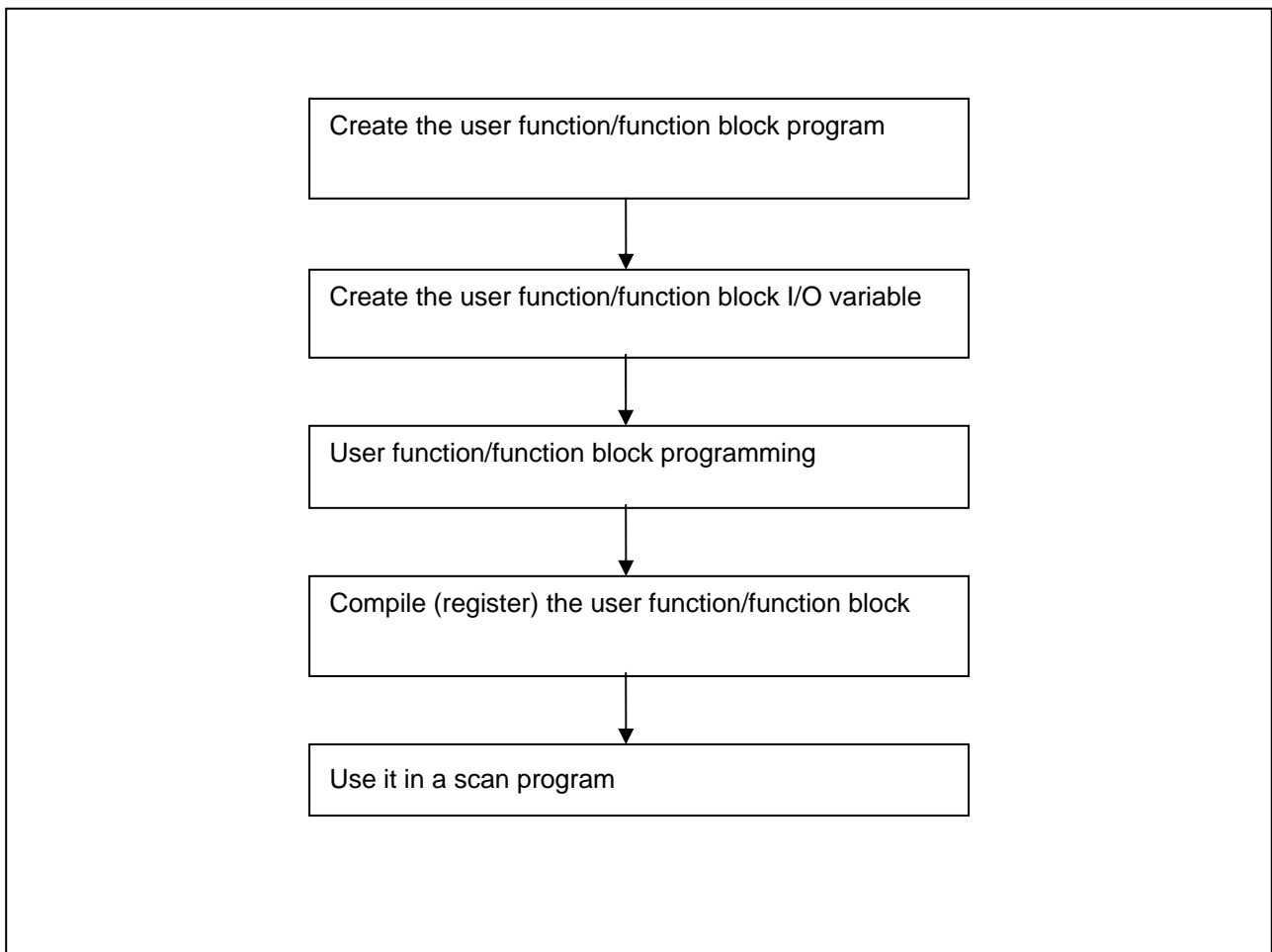

## 15.1 Create User Function/Function Block

### 15.1.1 Create User Function/Function Block Program

In order to create a User Function/Function Block, select [Project]-[Add Item]-[Function] or [Project]-[Add Item]-[Function Block].

[Dialog Box]

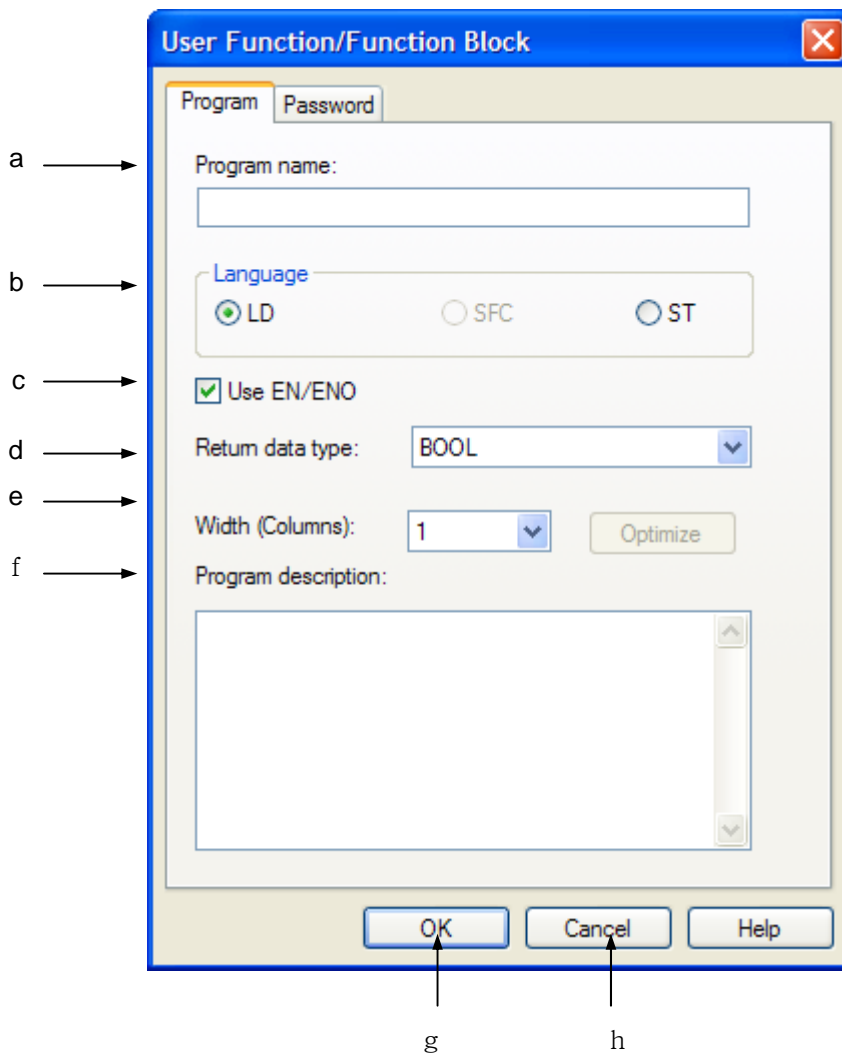

[Description of Dialog Box]

- a. Program Name: used to input a User Function/Function Block. When the user-defined function/function is registered, the input name is registered.
- b. Language: used to select a programming language for the User Function/Function Block. A user-defined function is created only by the LD language while a user-defined function block can be created by either the LD or SFC language.
- c. Use EN/ENO: used to select whether to use or not EN/ENO, which is used under the operation condition of function/function block. If not selecting EN/ENO, a user should declare BOOL type variable in the first input and first output parameters of the function/function block.
- d. Return Data Type: designates a type of the results after a user-defined function is executed. It is activated only when a user-defined function is created.
- e. Width (Columns): adjusts the width columns number of user function/function block
- f. Program description: used to input the comment of a User Function/Function Block. If unnecessary, the comment does not have to be input.
- g. OK: saves the input in the dialog box and closes the dialog box.
- h. Cancel: cancels the input in the dialog box and closes the dialog box.

### Notes

- If clicking OK button, a new item with the name input in the item of User Function/Function Block is created.

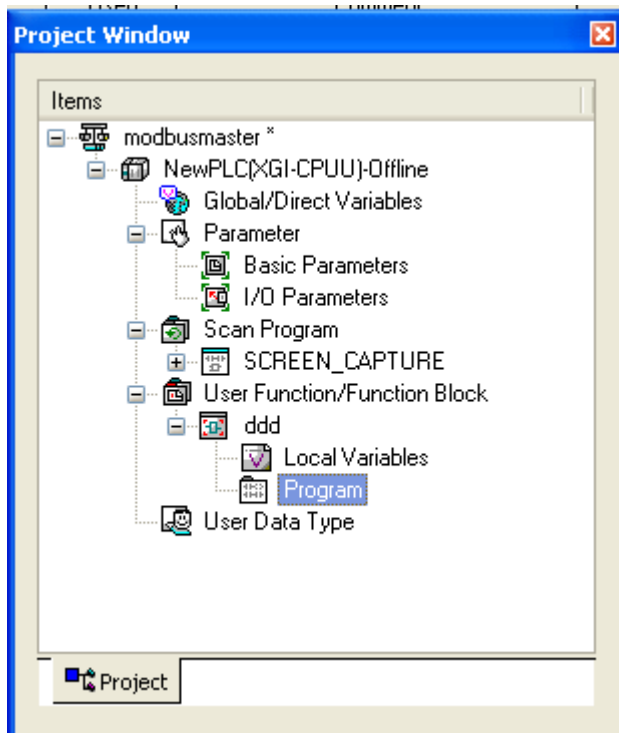

### 15.1.2 Create User Function/Function Block I/O Variable

[Steps]

1. If double-clicking a local variable among the items created with the name of User Function/Function Block, the following local variable screen is created.

[Local Variable screen]

	Variable Kind	Variable Name	Type	Used	Comment
1				<input type="checkbox"/>	
2				<input type="checkbox"/>	
3	VAR_RETURN	ddd	INT	<input type="checkbox"/>	
4				<input type="checkbox"/>	
5				<input type="checkbox"/>	
6				<input type="checkbox"/>	
7				<input type="checkbox"/>	

The diagram shows a function block with two input terminals on the left labeled 'EN' and 'ENO', both with 'BOOL' next to them. On the right, there are two output terminals: 'ENO' with 'BOOL' next to it, and 'ddd' with 'INT' next to it. An arrow labeled 'b' points to the 'EN' input terminal.

[Description of Local Variable]

- a. VAR\_RETURN: A type of variable representing the value of user-defined function. It is automatically created as a variable with the same name of the user-defined function with return type designated when creating a user-defined function.
- b. Function type: used to automatically display input variable, I/O variable, function/function block type by output variable in the local variable screen. The type is as same as when using the User Function/Function Block in the scan program.

2. Add input variable, I/O variable and output value in the local variable screen. Depending on the added I/O variables, the function/function block type is automatically changed on the bottom of the local variable screen.

	Variable Kind	Variable Name	Type	Used	Comment
1	VAR_INPUT	A	INT	<input type="checkbox"/>	
2	VAR_INPUT	C	INT	<input type="checkbox"/>	
3	VAR_RETURN	ddd	INT	<input type="checkbox"/>	
4	▼			<input type="checkbox"/>	

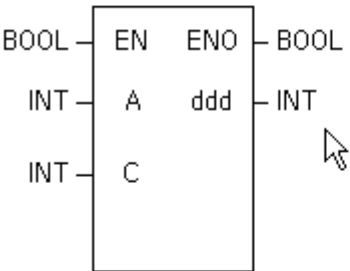
The diagram shows a rectangular function block with the following connections:

- Left side: Three input lines labeled "BOOL", "INT", and "INT".
- Right side: Three output lines labeled "BOOL", "INT", and "INT".
- Top: Two terminals labeled "EN" and "ENO".
- Bottom: Two terminals labeled "A" and "ddd".
- Internal: A terminal labeled "C" is located between the bottom "A" and "ddd" terminals.

A mouse cursor is pointing at the "INT" output terminal on the right side.

### Notes

- Input variable and output variable should be, at least, one or more, respectively but the number is limited to 64.

### 15.1.3 User Function/Function Block Programming

[Steps]

1. If double-clicking a program among the items created with the newly input name in the User Function/Function Block, a program screen with the previously designated language appears. The following screen shows the screen created when selecting the LD.



# Chapter 15 User Function/Function Block

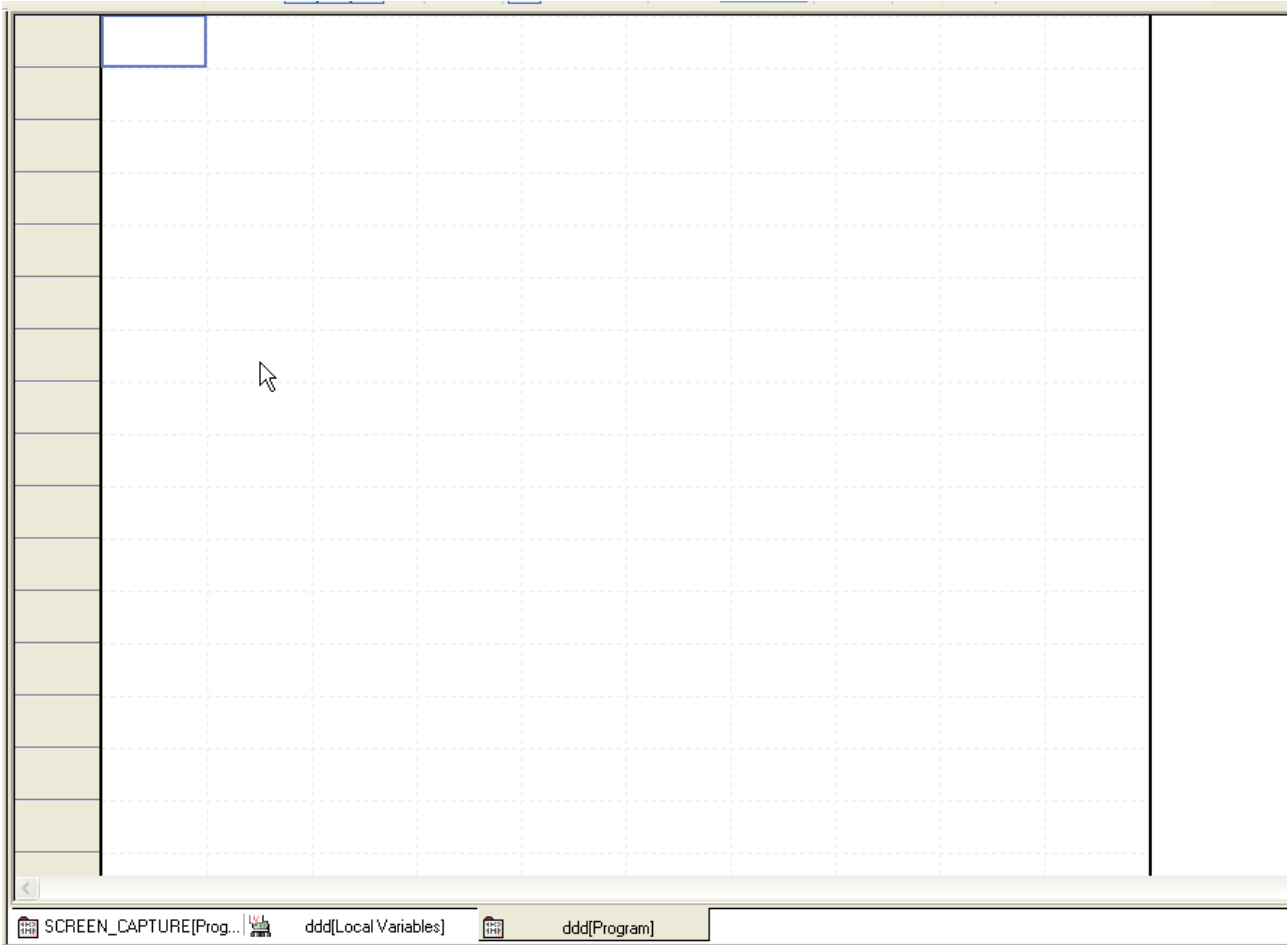

2. Create a program, based on the variable input in the local variable screen.

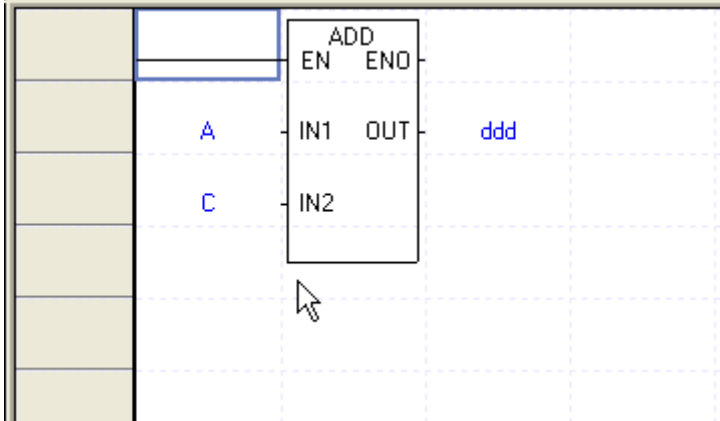

Notes

- If local variable edit and program edit are finished, select function/function block toolbar instruction to check whether the edited User Function/Function Block is registered.

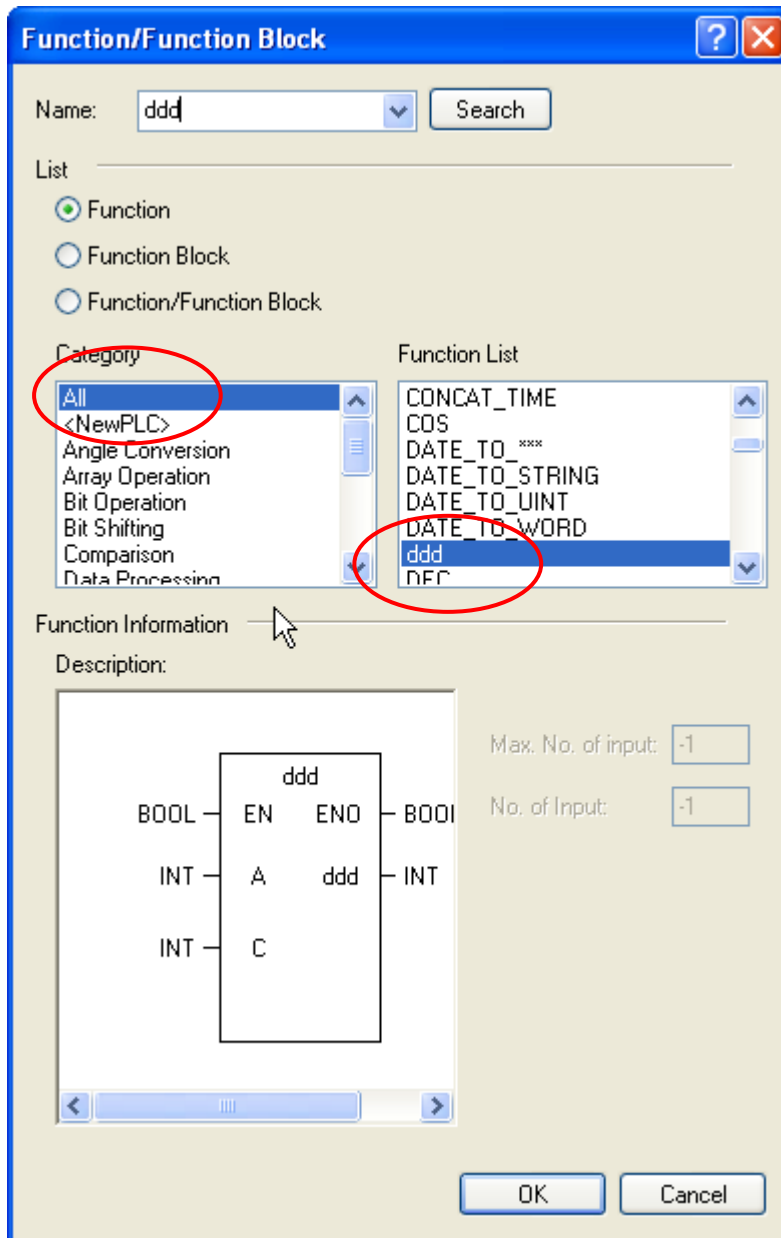

### 15.2 Use User Function/Function Block

[Steps]

1. Open the program to use a User Function/Function Block and move the cursor to the position to input.

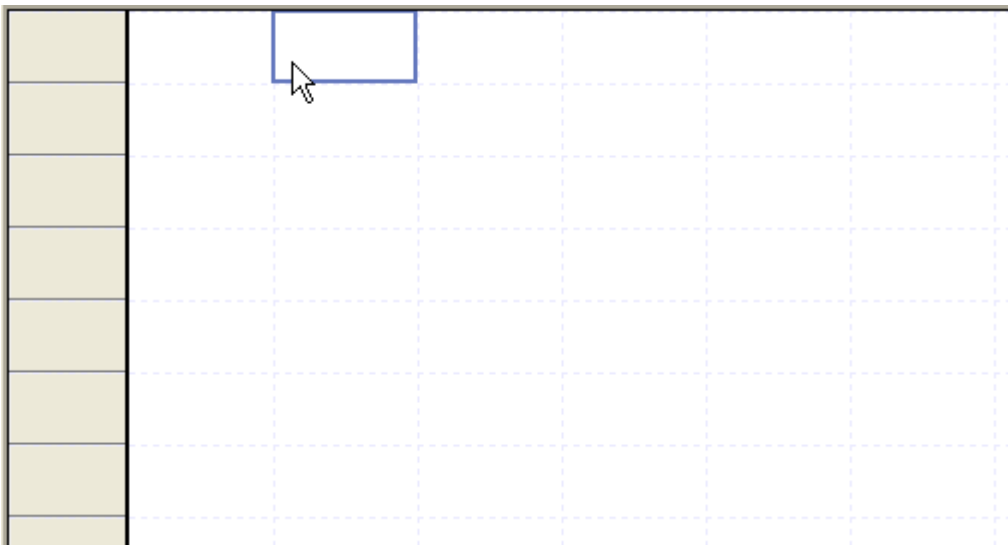

2. Click Function/Function Block Toolbar.

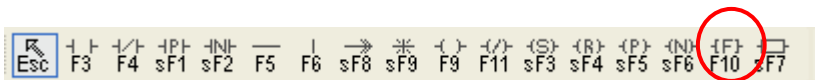

3. Select a User Function/Function Block in the function/function block dialog box.

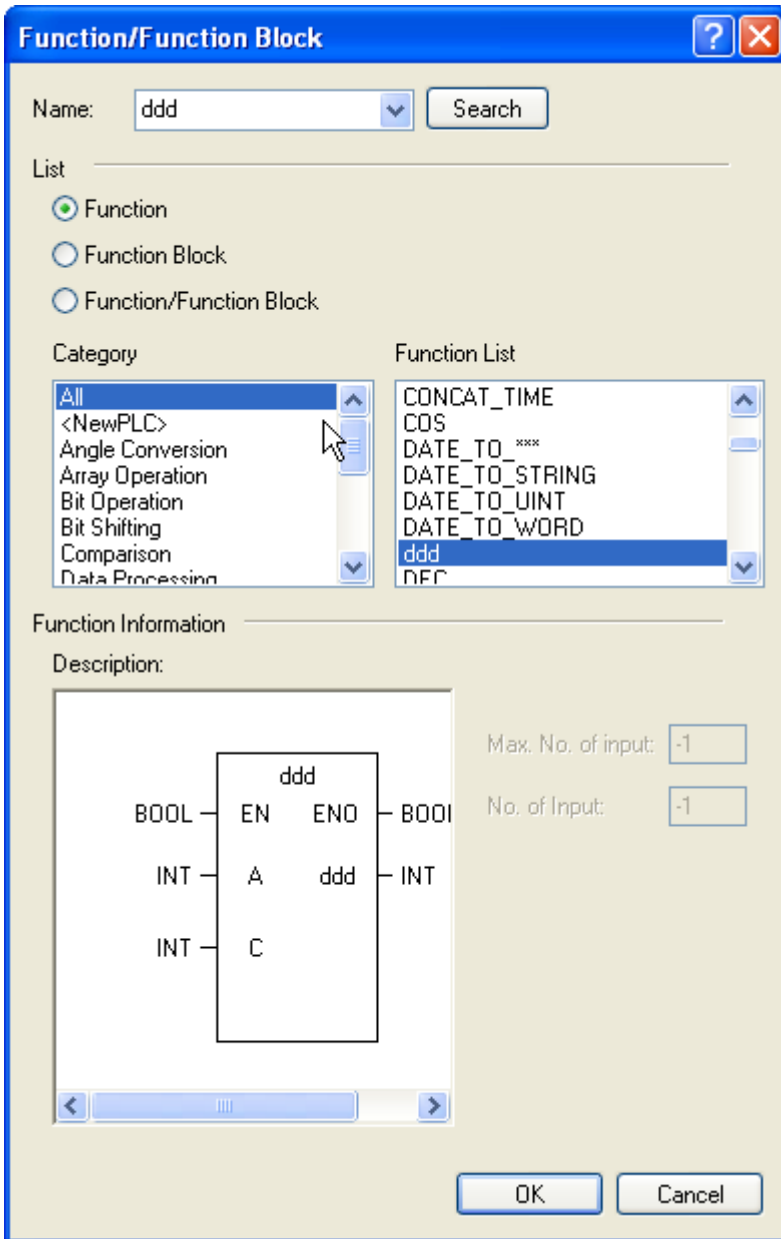

4. Input the variable to be used in the input/output of function/function block.

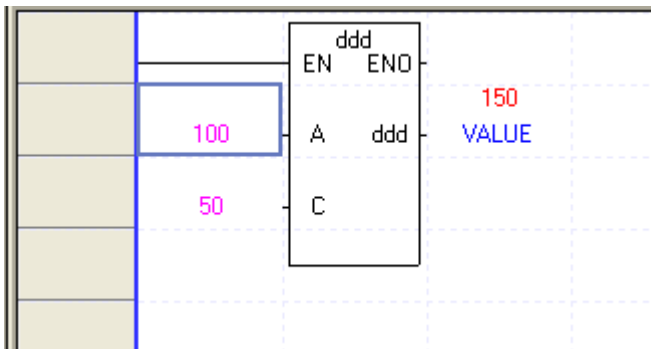

## Chapter 16 XG-SIM

### 16.1 Getting Started

#### 16.1.1 Features of XG-SIM

XG-SIM is a Windows-based virtual PLC for XGT PLC series. If using XG-SIM, an operator may execute a created program without PLC and debug a PLC program by using the functions of input setup and module simulation.

XG-SIM supports the following functions.

##### 1) Program simulation

An operator can simulate a program created by LD/SFC/ST languages. In addition, it supports modification function during run, with which an operator may apply modification during run of a program that is operated in XG-SIM, and it supports debugging function that trace a user-created program by unit of step.

##### 2) PLC Online function

Besides program monitoring function provided by XG5000, an operator may use online diagnosis functions such as system monitor, device monitor, trend monitor, data trace and user event.

##### 3) Module simulation

It also supports simple simulation function for modules mountable on XGK rack type PLC, such as digital I/O module, A/D conversion module, D/A conversion module, high speed counter, temperature control module and positioning module. If using the module simulation function, a program may be simulated by using input values from module.

##### 4) I/O input condition setup

The value of device may be set with value of specific device or channel value in a module set as input conditions. Using I/O input condition setup function may realize the program simulation as created with no PLC program separately created to test a created PLC program.

## 16.1.2 System Requirements for the Execution of XG-SIM

Minimum requirements: Pentium3 900MHz, 256MB RAM  
 Recommended requirements: Pentium4 1.5GHz, 512MB and higher RAM

XG-SIM requires higher system specifications than XG5000. If the minimum requirements are adopted, scan cycle may be extended longer than the set fixed cycle and constant scan may not work properly, probably resulting interruption of access. In addition, even the recommended requirements may suffer from the same symptoms. Then, irrespective of system requirements, access may be interrupted according to user's setting such as SLEEP mode.

**Notes**

- If using fixed cycle, fixed cycle error/warning dialog box is not displayed.

## 16.1.3 XG-SIM Execution

1. By executing XG5000, create a program to run on XG-SIM.

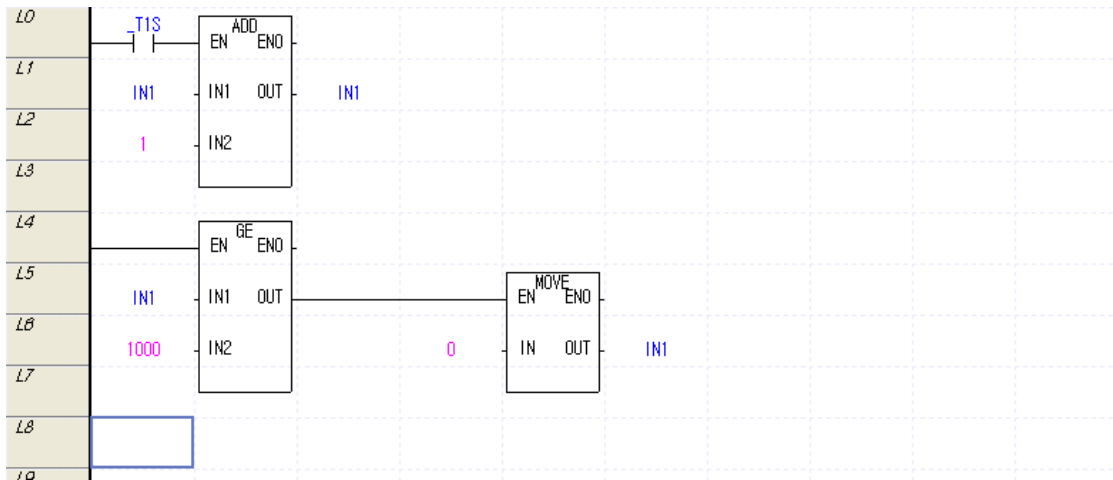

2. Select [Tools] – [Start Simulator] in XG5000 Menu. If XG-SIM is started, a created program is automatically downloaded onto XG-SIM. After XG-SIM is executed, it goes to Online, Access and Stop.

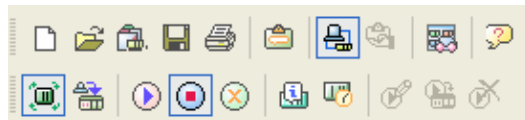

3. By selecting [Online] – [Change Mode] – [Run] in XG5000 Menu, execute the downloaded program. For available online menus of XG5000 when XG-SIM is executed, refer to the following table.

Menu	Support	Menu	Support
Open from PLC	○	Fault mask setup	×
Convert mode (run)	○	Module change wizard	×
Convert mode (stop)	○	Start modification during run	○
Convert mode (debug)	○	Write modification during run	○
Disconnect	×	End modification during run	○
Read	×	Start/end monitor	○
Write	○	Pause monitor	○
Compare to PLC	×	Resume monitor	○
Flash memory setup (set)	×	Monitor pause setup	○
Flash memory setup (cancel)	×	Change current value	○
PLC Reset	×	System monitor	○
PLC Removal	○	Device monitor	○
PLC info (CPU)	○	Special module monitor	○
PLC info (Performance)	○	User event	○
PLC info (password)	○	Data trace	○
PLC info (PLC clock)	○	Start/end debug	○
PLC history (error log)	○	Debug (run)	○
PLC history (mode conversion log)	○	Debug (step over)	○
PLC history (power off log)	○	Debug (step in)	○
PLC history (system log)	○	Debug (step out)	○
PLC error warning	○	Debug (move to cursor)	○
I/O info	○	Set/cancel break point	○
Forced I/O setup	○	Break point list	○
I/O skip setup	○	Break condition	○

16.2 XG-SIM

16.2.1 Program Window Configuration

XG-SIM program is configured as follows.

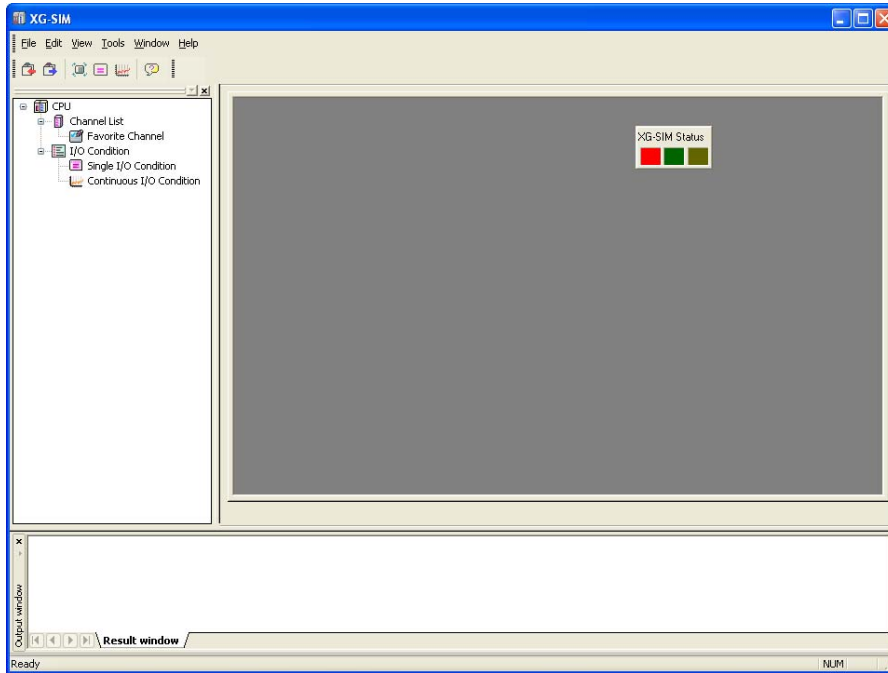

1) Channel list

It displays channels by modules and user's favorable channels. In case of module, it displays the only modules set in I/O parameter. Module is displayed in a format of 'B0 (base number) S00 (slot number): module name.'

2) I/O condition



It displays single/continuous I/O conditions.

3) Status display

It displays the status of simulator.

Status	Description	Display
Initial	Shows initial status. Not accessible by simulator	

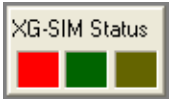
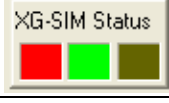

Status	Description	Display
Accessible	Shows the status of access ready. Red LED lights up.	
Single I/O condition executed	Shows single I/O condition is executed, during which green LED blinks.	
Continuous I/O condition executed	Shows continuous I/O condition is executed, during which yellow LED blinks	

## 16.2.2 Channel List

### 1) Module Channel

Double-click an item to view its channel in the tree view.

To register a channel as a favorable channel, check the 'checkbox' of favorable channel.

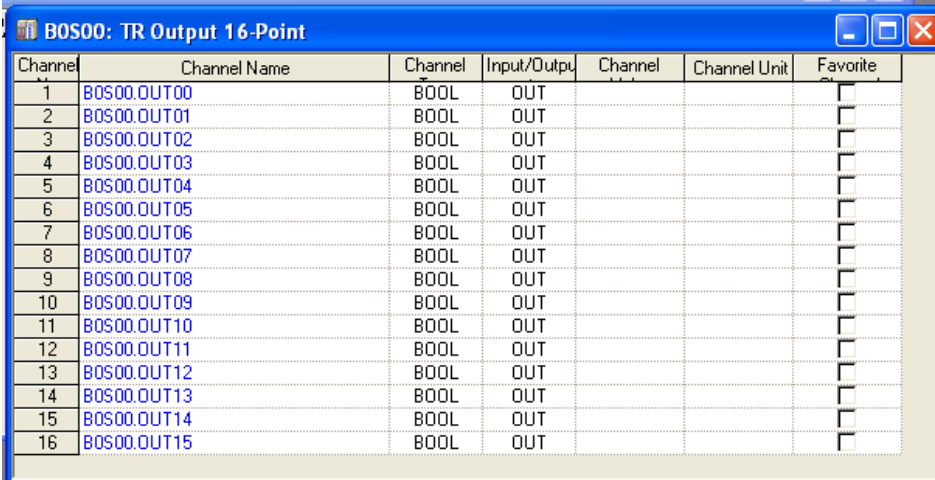

Channel	Channel Name	Channel	Input/Output	Channel	Channel Unit	Favorite
1	BOS00.OUT00	BOOL	OUT			<input type="checkbox"/>
2	BOS00.OUT01	BOOL	OUT			<input type="checkbox"/>
3	BOS00.OUT02	BOOL	OUT			<input type="checkbox"/>
4	BOS00.OUT03	BOOL	OUT			<input type="checkbox"/>
5	BOS00.OUT04	BOOL	OUT			<input type="checkbox"/>
6	BOS00.OUT05	BOOL	OUT			<input type="checkbox"/>
7	BOS00.OUT06	BOOL	OUT			<input type="checkbox"/>
8	BOS00.OUT07	BOOL	OUT			<input type="checkbox"/>
9	BOS00.OUT08	BOOL	OUT			<input type="checkbox"/>
10	BOS00.OUT09	BOOL	OUT			<input type="checkbox"/>
11	BOS00.OUT10	BOOL	OUT			<input type="checkbox"/>
12	BOS00.OUT11	BOOL	OUT			<input type="checkbox"/>
13	BOS00.OUT12	BOOL	OUT			<input type="checkbox"/>
14	BOS00.OUT13	BOOL	OUT			<input type="checkbox"/>
15	BOS00.OUT14	BOOL	OUT			<input type="checkbox"/>
16	BOS00.OUT15	BOOL	OUT			<input type="checkbox"/>

### 2) Channel monitor

#### 1. Start monitor

[Steps]

a. Select [Tools] – [Start channel monitoring] in Menu.

#### 2. Change current value of channel

[Steps]

## Chapter 16 XG-SIM

- Select a channel of which current value is to be changed.
- Move from a selected channel to a column of current value.
- By double-clicking or pressing Enter key, display the dialog box of change channel value.

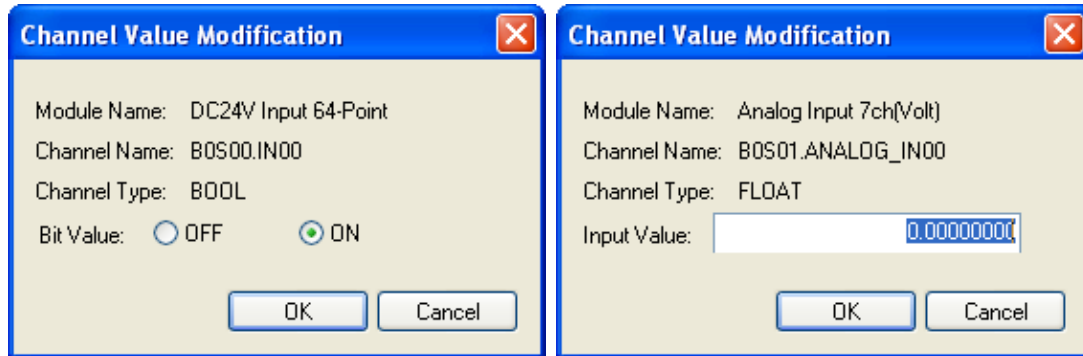

[Description of Dialogue Box]

- Module name: displays a selected module's name.
- Channel name: displays a selected channel's name.
- Channel type: displays the data type of a selected channel
- Bit value: selects ON/OFF in case of bit type
- Input value: directly enters a value in case of other types

### Notes

- If I/O direction is OUT, the current value of a channel may not be changed.

### 3. End monitor

[Steps]

Select [Tools] – [End channel monitor] in Menu.

### 16.2.3 I/O Condition

I/O condition means the function to forcibly record a user-present value into a specific device when meeting conditions that are entered by a user. For instance, in a statement, 'if Device%IX0.0.0 is 1, set all the values of device %MX0 ~ %MX100 as 1', 'if Device%IX0.0.0 is 1' constitutes the condition and 'set all the values of device %MX0 ~ %MX100 as 1' is 'recording the user-preset value forcibly.'

XG-SIM provides I/O condition function to eliminate discomfort that to test a user-created PLC program, a user should periodically change device value by changing the monitor current value of XG5000 or should create another PLC program to test PLC program. In addition, with I/O condition, it may advantageously reflect the data sending to a module or receiving from a module to a program.

#### 1) Conditional statement

It describes conditional statement used in single input condition or continuous input condition. A conditional statement consists of one or

more conditions while a conditional statement may be used as one or more statements through the combination of conditions

Type	Operator	Priority	Description
Single comparison	==	4	Equal to
	!=	5	Not equal to
	>	6	Larger than
	>=	7	Equal to or larger than
	<=	8	Equal to or smaller than
	<	9	Smaller than
Four operations	+	2	Add
	-	3	Subtract
	*	0	Multiply
	/	1	Divide
Bit operation	&	12	Bit multiply
		13	Bit sum
	^	14	Beta bit sum
Logic operation	&&	10	Logical multiply
		11	Logical sum
Others	(	-	
	)	-	

Where, device or channel is to be compared. For instance, if expressing '%MW0 is larger than 100 and device %MX10 is On' as a conditional statement, it may be expressed as follows.

```
(%MW0 > 100) && (%MX10 == TRUE)
```

It supports five types of devices such as %I, %Q, %M, %R and %W.

## Chapter 16 XG-SIM

### 2) Basic functions

Both single I/O condition and continuous I/O condition keep the following interface.

Condition	Condition	Condition Name	Condition Status	Condition Comment
1	<input type="checkbox"/>			
2	<input type="checkbox"/>			
3	<input type="checkbox"/>			
4	<input type="checkbox"/>			
5	<input type="checkbox"/>			
6	<input type="checkbox"/>			
7	<input type="checkbox"/>			
8	<input type="checkbox"/>			
9	<input type="checkbox"/>			
10	<input type="checkbox"/>			

Cut	Ctrl+X
Copy	Ctrl+C
Paste	Ctrl+P
Delete	Delete
Insert Line	Ctrl+L
Delete Line	Ctrl+D
Condition Up	Ctrl+U
Condition Down	Ctrl+J
Properties	Ctrl+Enter

#### 1. Input I/O condition

[Steps]

- Move to a position to enter new I/O condition.
- Select [Edit] – [Properties] in Menu.
- Edit I/O condition dialog box and click OK.

Condition	Condition	Condition Name	Condition Status	Condition Comment
1	<input checked="" type="checkbox"/>	Before Editing		
2	<input type="checkbox"/>			
3	<input type="checkbox"/>			
4	<input type="checkbox"/>			

#### 2. Edit I/O condition

[Steps]

- Select I/O condition to edit.
- Select [Edit] – [Properties] in Menu.
- Change an item in the I/O condition dialog box and click OK.

Condition	Condition	Condition Name	Condition Status	Condition Comment
1	<input checked="" type="checkbox"/>	After Editing		
2	<input type="checkbox"/>			
3	<input type="checkbox"/>			
4	<input type="checkbox"/>			

### 3. Cut/Paste I/O Condition

[Steps]

- a. Select the I/O condition to cut.
- b. Select [Edit] – [Cut] in Menu.
- c. Move to a position to paste and select [Edit] – [Paste] in Menu.

Conditio	Condition	Condition Name	Condition Status	Condition Comment
1	<input checked="" type="checkbox"/>	Cut		
2	<input type="checkbox"/>			
3	<input type="checkbox"/>			
4	<input type="checkbox"/>			
5	<input type="checkbox"/>			

Conditio	Condition	Condition Name	Condition Status	Condition Comment
1	<input type="checkbox"/>			
2	<input checked="" type="checkbox"/>	Cut		
3	<input type="checkbox"/>			
4	<input type="checkbox"/>			
5	<input type="checkbox"/>			

### 4. Copy/Past I/O Condition

[Steps]

- a. Select I/O condition to copy.
- b. Select [Edit] – [Copy] in Menu.
- c. Move to a position to paste and select [Edit] – [Paste] in Menu.

Conditio	Condition	Condition Name	Condition Status	Condition Comment
1	<input type="checkbox"/>			
2	<input checked="" type="checkbox"/>	Cut		
3	<input type="checkbox"/>			
4	<input type="checkbox"/>			
5	<input type="checkbox"/>			

Conditio	Condition	Condition Name	Condition Status	Condition Comment
1	<input type="checkbox"/>			
2	<input checked="" type="checkbox"/>	Cut		
3	<input checked="" type="checkbox"/>	Cut		
4	<input type="checkbox"/>			
5	<input type="checkbox"/>			
6	<input type="checkbox"/>			
7	<input type="checkbox"/>			

## Chapter 16 XG-SIM

### 5. Delete I/O Condition

[Steps]

- a. Select I/O condition to delete.
- b. Select [Edit] – [Delete].

Condition	Condition	Condition Name	Condition Status	Condition Comment
1	<input type="checkbox"/>			
2	<input checked="" type="checkbox"/>	Cut		
3	<input checked="" type="checkbox"/>	Cut		
4	<input type="checkbox"/>			
5	<input type="checkbox"/>			
6	<input type="checkbox"/>			
7	<input type="checkbox"/>			

Condition	Condition	Condition Name	Condition Status	Condition Comment
1	<input type="checkbox"/>			
2	<input type="checkbox"/>			
3	<input checked="" type="checkbox"/>	Cut		
4	<input type="checkbox"/>			
5	<input type="checkbox"/>			

### 6. Insert line

[Steps]

- a. Select a position to insert a line
- b. Select [Edit] – [Insert Line] in Menu.

Condition	Condition	Condition Name	Condition Status	Condition Comment
1	<input type="checkbox"/>			
2	<input type="checkbox"/>			
3	<input checked="" type="checkbox"/>	Cut		
4	<input type="checkbox"/>			
5	<input type="checkbox"/>			
6	<input type="checkbox"/>			
7	<input type="checkbox"/>			
8	<input type="checkbox"/>			

Condition	Condition	Condition Name	Condition Status	Condition Comment
1	<input type="checkbox"/>			
2	<input type="checkbox"/>			
3	<input type="checkbox"/>			
4	<input checked="" type="checkbox"/>	Cut		
5	<input type="checkbox"/>			

7. Delete line

[Steps]

- a. Select a position to delete a line.
- b. Select [Edit] – [Delete Line] in Menu.

Condition	Condition	Condition Name	Condition Status	Condition Comment
1	<input type="checkbox"/>			
2	<input type="checkbox"/>			
3	<input type="checkbox"/>			
4	<input checked="" type="checkbox"/>	Cut		
5	<input type="checkbox"/>			
6	<input type="checkbox"/>			
7	<input type="checkbox"/>			
8	<input type="checkbox"/>			
9	<input type="checkbox"/>			

Condition	Condition	Condition Name	Condition Status	Condition Comment
1	<input type="checkbox"/>			
2	<input type="checkbox"/>			
3	<input checked="" type="checkbox"/>	Cut		
4	<input type="checkbox"/>			
5	<input type="checkbox"/>			

3) Single I/O Condition

Single I/O condition copies the value entered into a selected device/channel if meeting the operation option.

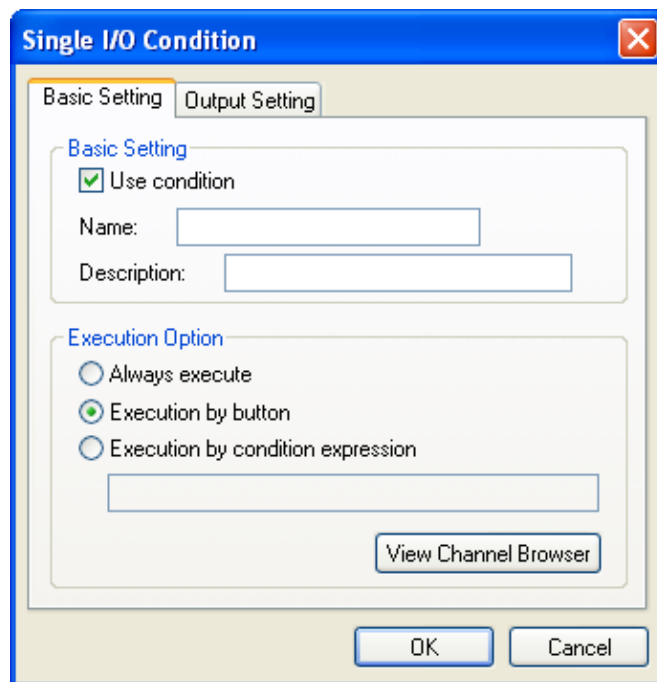

## Chapter 16 XG-SIM

### [Description of Dialog Box – Basic Setting]

- a. Use condition: sets whether to apply single I/O condition. If not allowing the use, XG-SIM does not use the condition set by a user.
- b. Name: enter the name of I/O condition.
- c. Description: enter a simple comment for I/O condition.
- d. Always execute: sets it to start operation as soon as it is executed, irrespective of user-designated condition.
- e. Execution by Button: sets it to execute a preset condition only when a user presses buttons.
- f. Execution by condition expression: sets it to execute a condition only when meeting a user-present conditional statement.
- g. View Channel Browser: displays a channel finder. The related buttons are activated only when selecting the operation by its conditional statement.

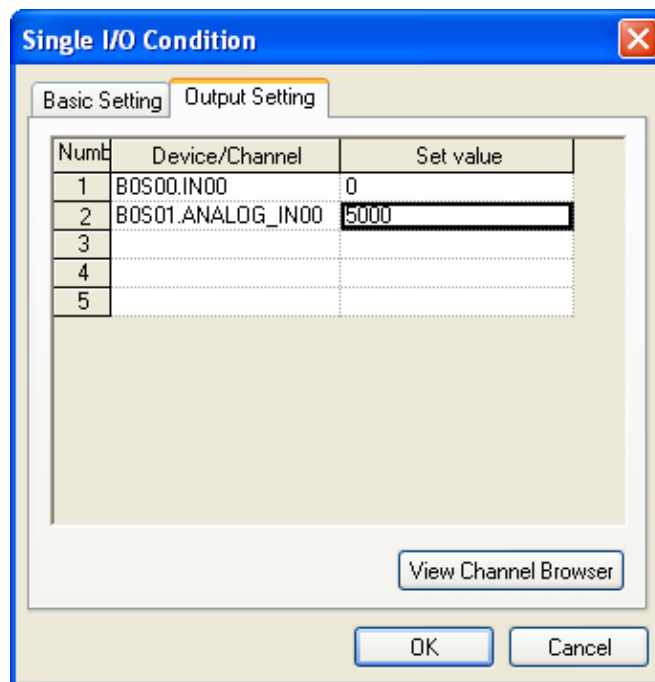

### [Description of Dialog Box – Output Setting]

- a. Device/Channel: enter the name of channel/device to record output value.
- b. Set value: enter a value to set. Device, channel or constant may be entered.



## 4) Continuous I/O condition

Continuous I/O condition enters a value entered into the selected device/channel when meeting the operation option.

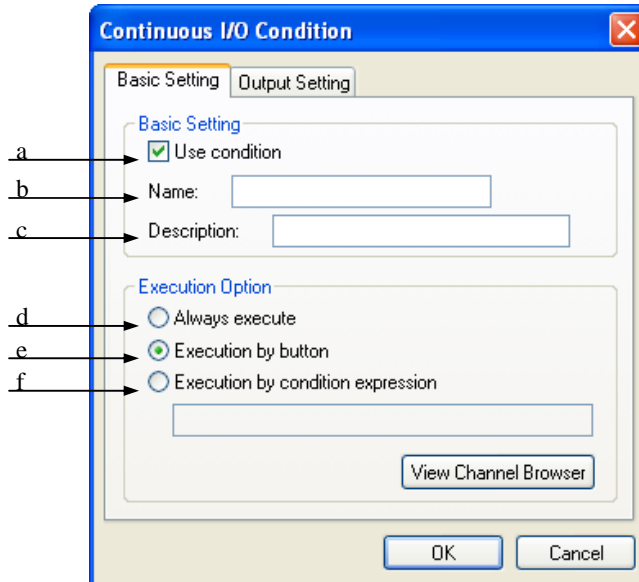

[Description of Dialog Box – Basic Setting]

- a. Use condition: sets whether to apply continuous I/O condition. If not allowing the use, XG-SIM does not use the condition set by a user.
- b. Name: enter the name of I/O condition.
- c. Description: enter a simple comment for I/O condition.
- d. Always execute: sets it to start operation as soon as it is executed, irrespective of user-designated condition.
- e. Execution by Button: sets it to execute a preset condition only when a user presses buttons.
- f. Execution by conditional expression: sets it to execute a condition only when meeting a user-present conditional statement.
- g. View Channel Browser: display a channel finder. The related buttons are activated only when selecting the operation by its conditional statement.

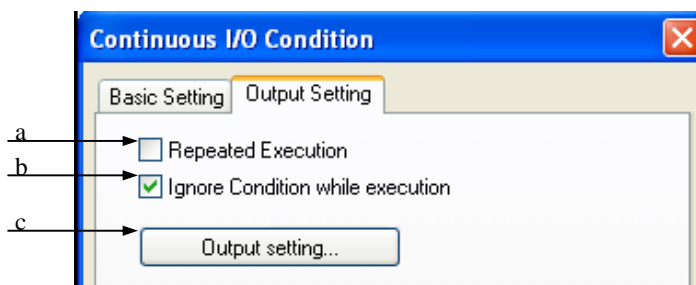

[Description of Dialog Box – Output Setting]

- a. Repeated Execution: selects whether to enter output repetitively.
- b. Ignore Condition while execution: selects whether to inspect operation condition while entering continuous value.
- c. Output setting: displays the dialog box to set continuous value

## Notes

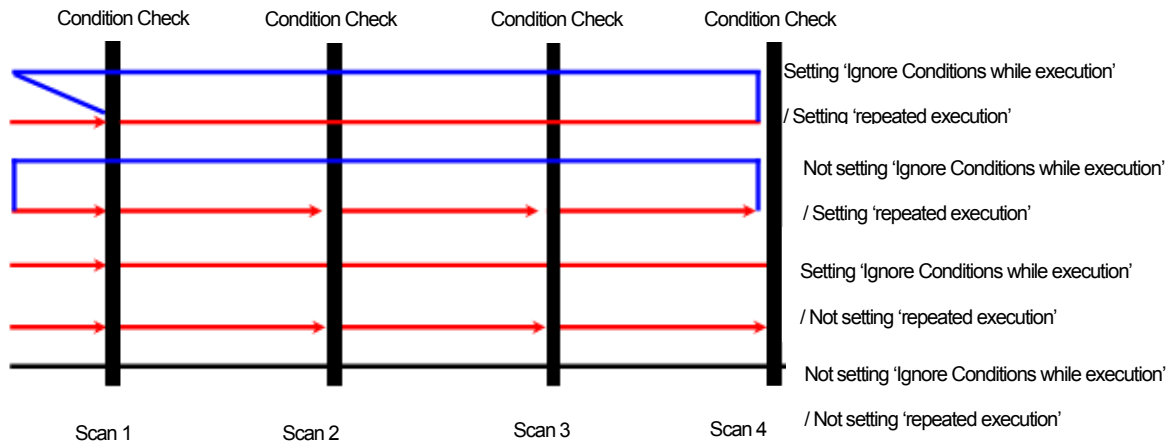

In the continuous I/O setup, XG-SIM writes every value inserted in continuous value setup into the related device/channel **every time scan is executed**. At the moment, it does not designate 'Always execute' or it continues to write the only first value set in the continuous value of a scan **unless selecting** 'Ignore conditions while execution' or using a true conditional statement. In addition, if **setting** Repeat Operation, it repetitively operates from the first scan after completing all scans.

Continuous value no.	1	2	3	4	5	6	7
Value to designate	7	6	5	4	3	2	1

For instance, in the above continuous value,

① Not setting 'Ignore Condition while Execution' / not setting 'Repeated Execution' (if button operation/conditional statement is false)

7 → 7 → 7 → 7 → 7 → 7 → 7 → 7

② Not setting 'Ignore Condition while Execution' / not setting 'Repeated Execution' (if Always execute/conditional statement is true)

7 → 6 → 5 → 4 → 3 → 2 → 1

③ Setting 'Ignore Condition while Execution' / not setting 'Repeated Execution'

7 → 6 → 5 → 4 → 3 → 2 → 1

④ Not setting 'Ignore Condition while Execution' / setting 'Repeated Execution' (if button operation/conditional statement is false)

7 → 7 → 7 → 7 → 7 → 7 → 7 → 7 → 7 → 7 → 7 → 7 → 7 → 7 → ...

⑤ Not setting 'Ignore Condition while Execution' / setting 'Repeat Execution' (if Always execute/Conditional statement is true)

7 → 6 → 5 → 4 → 3 → 2 → 1 → 7 → 6 → 5 → 4 → 3 → 2 → 1 → ...

⑥ Setting 'Ignore Condition while Execution' / setting 'Repeated Execution'

7 → 6 → 5 → 4 → 3 → 2 → 1 → 7 → 6 → 5 → 4 → 3 → 2 → 1 → ...

## 5) Dialog Box to input continuous value

## 1. Input value

Input a value to set as output in Continuous I/O condition

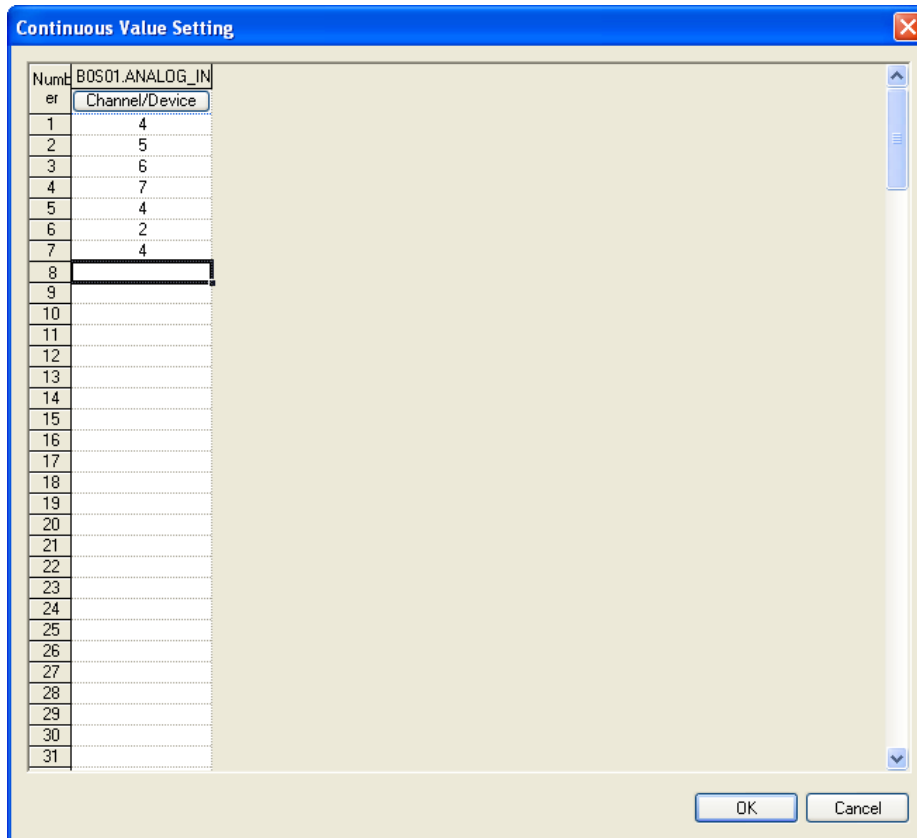

## [Description of Dialog Box]

- Device/Channel: enter a device/channel to set its value.
- Value: the only constant such as integer, real number, hexadecimal or True/False may be entered.
- OK: saves edited items and exits the dialog box.
- Cancel: cancels values entered.

## 2. Select Device/Channel

Select a device/channel to enter its continuous value.

## [Steps]

- Double-click a column to enter device/channel
- Then, dialog box to enter device/channel is displayed.
- Enter a device/channel and click OK.

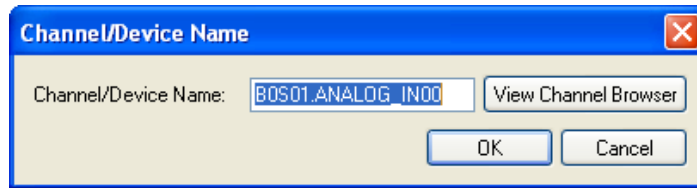

[Description of Dialog Box]

- a. Channel/Device Name: enter the name of a channel/device.
- b. View Channel Browser: displays a channel finder.
- c. OK: saves edited items and exits the dialog box.
- d. Cancel: cancels edited items and exists the dialog box.

### 3. Input value

[Steps]

- a. Move a cursor to enter a value
- b. Enter a value.

### 4. Auto Filling

[Steps]

- a. Select an area.

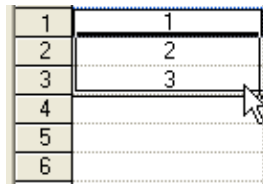

- b. Cursor is changed if placing it on the right corner of a selected area.

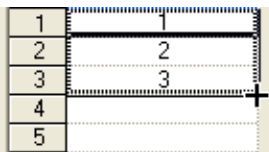

- c. With the left button pressed, drag it up or down.

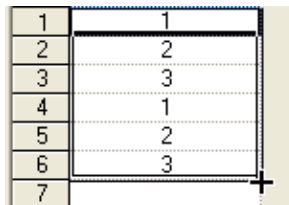

#### Notes

- If using Ctrl key for Auto Filling, it is possible to enter continuous value of monotonic increase/monotonic decrease, depending on dragging direction.

## 6) Monitor I/O Condition

## 1. Start Monitor

[Steps]

- a. Select [Tools] – [Use Single I/O Condition] or [Tools] – [Use Continuous I/O Condition] in Menu.

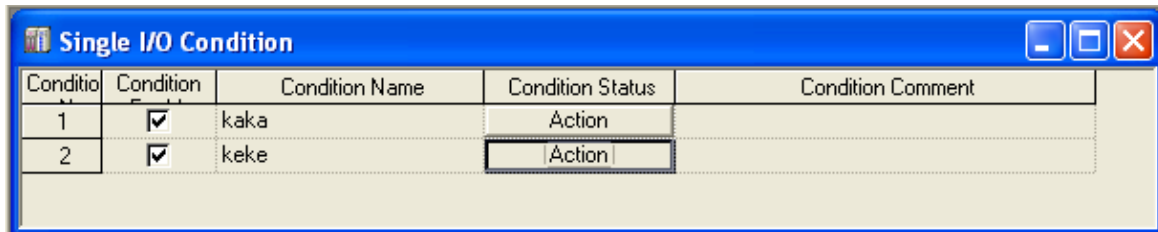

## 2. End Monitor

[Steps]

- a. Deselect [Tools] – [Use Single I/O Condition] or [Tools] – [Use Continuous I/O Condition] in Menu.

**Notes**

- Program scan is the procedure that operations are repetitively executed from the first to the last step of a program created by the basic program execution scheme of PLC. XG-SIM also executes operations through scan and keeps the following procedure.

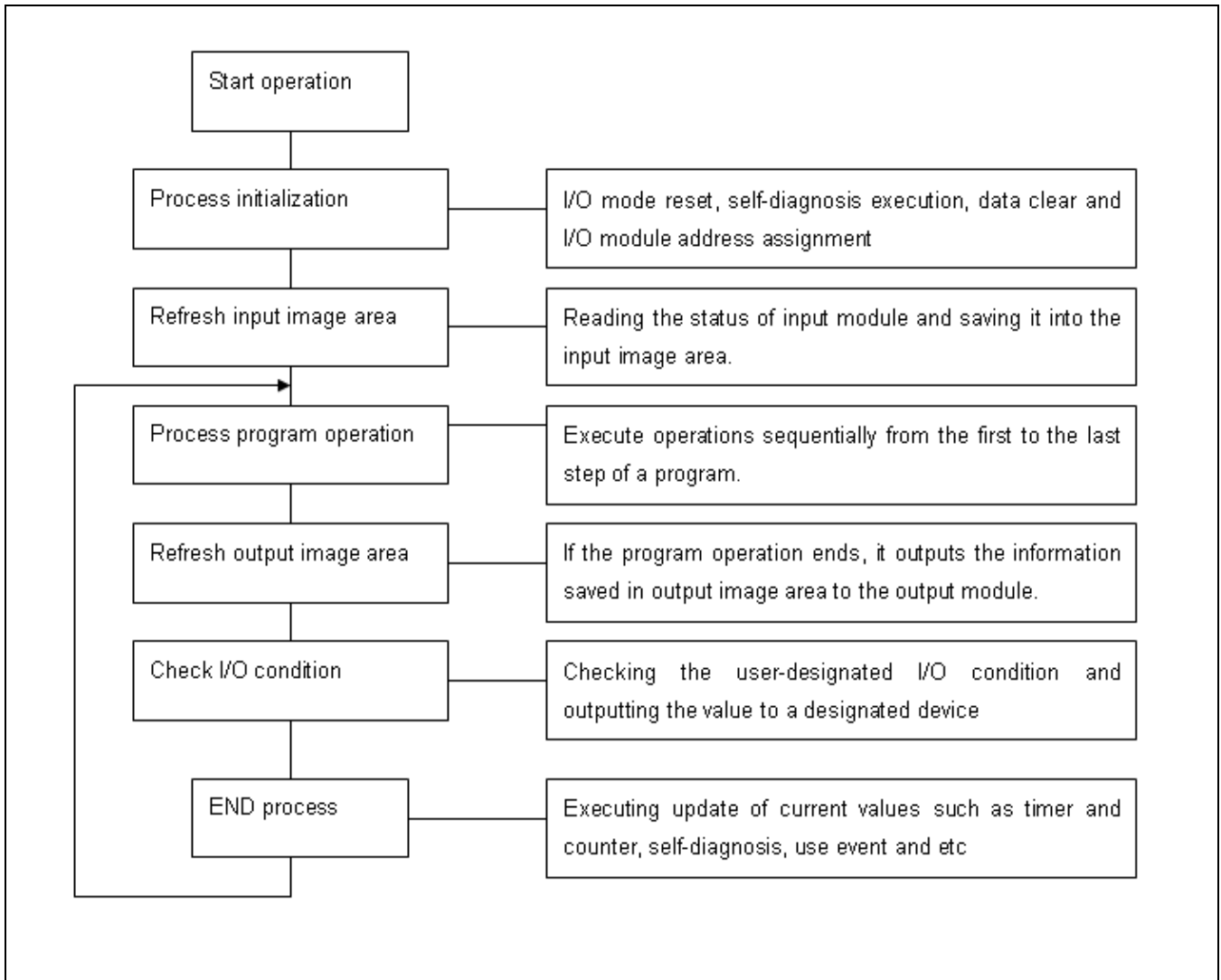

### 16.2.4 Module Simulation

XG-SIM provides a simple simulation function for I/O module and special module. In case of digital I/O module, it supports I/O function for I or Q area; in case of special module, it supports the monitoring function for analogue value receiving from or sending to outside.

#### 1) Module setting

The module simulation function provided by XG-SIM uses the information set in the I/O parameter of XG5000. Therefore, it is necessary to set a module in the I/O parameter to simulate the module and reflect to a program.

For instance, to simulate the PLC system with the following configuration, it is necessary to set I/O parameter as presented in the figure.

Base	Slot	Module	Module type
Basic base	0	XGI-D21A	DC 24V 8 point input module
Basic base	1	XGF-AV8A	Voltage type A/D conversion module(8 ch)
Basic base	2	XGF-HO2A	Open collector type high speed counter module(2 ch)

Slot	Module	Comment	Input Filter
0	DC 24V INPUT, 8points		3 Standard [ms]
1	XGF-AV8A (Voltage, 8-CH)		-
2	XGF-HO2A (Open-Collector)		-
3			

After XG-SIM is executed, system monitor shows the module set in I/O parameter as presented in the figure.

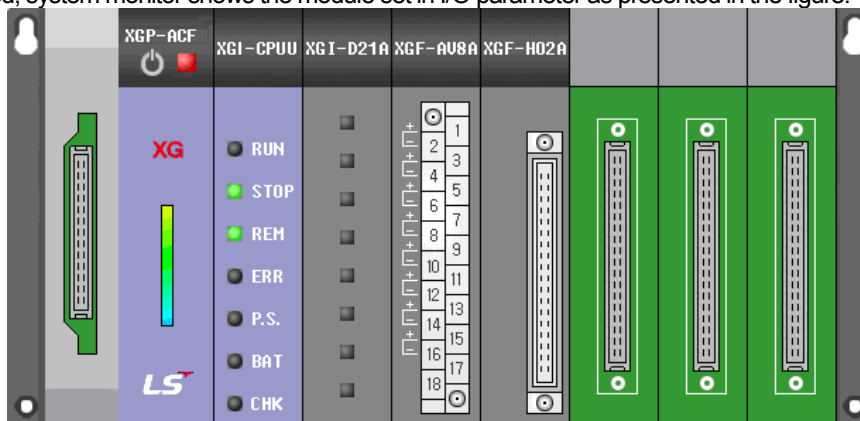

**Notes**

- For details of I/O parameter editing and the parameter setting by modules, refer to XG5000 Manual.
- To apply the details of I/O parameter set in XG5000, it is necessary to download I/O parameter to XG-SIM again. If the type of a selected module is changed, XG-SIM should be executed again.

2) Digital I/O Module

Digital I/O module simulation may change the current value of contact or simulate whether the output used as the output in the program is normally outputted. It may be different as follows, depending on the I/O module setting in I/O parameter.

	Not setting I/O module	Setting I/O module
Change Input	Use the monitor's current value change	Use the XG-SIM channel value change
Change output	Unable to change	Unable to change
Forcible I/O input	Not applicable	Input forcibly set input
Forcible I/O output	Not applicable	Output forcibly set output

## Chapter 16 XG-SIM

### 3) Analog Input Module (A/D conversion module)

For the analog input module supported by XG-SIM, refer to the following table.

Module name	Support
XGF-AV8A (Voltage type 8ch)	○
XGF-AC8A (Current type 8ch)	○
XGF-AD4S (Insulation type 4ch)	X

XG-SIM supports 4 types of input voltage ranges and digital data formats and 2 kinds of input current ranges as follows.

Input voltage range	Input current range	Digital output format
1 ~ 5V	4 ~ 20mA	0 ~ 16000
0 ~ 5V	0 ~ 20mA	-8000 ~ 8000
0 ~ 10V	-	1000 ~ 5000
-10 ~ 10V	-	0 ~ 10000 (%)

XG-SIM supports the following analog input parameters.

Parameter	Support	Parameter	Support
Operation channel	○	Filter constant	○
Input voltage(current) range	○	Averaging	○
Output data type	○	Averaging method	○
Filter process	X	Average	○

Analog input may be directly set in XG-SIM window and the input range is valid only within the input voltage(current) range set in the parameter.

#### Notes

- For the details on the parameters of analog input module and the programming, refer to the manual of a module.



Analog input may be set in 'Channel' item of XG-SIM window.

Channel	Channel Name	Channel	Input/Output	Channel	Channel Unit	Favorite
1	BOS01.ANALOG_IN00	FLOAT	IN		volt	<input type="checkbox"/>
2	BOS01.ANALOG_IN01	FLOAT	IN		volt	<input type="checkbox"/>
3	BOS01.ANALOG_IN02	FLOAT	IN		volt	<input type="checkbox"/>
4	BOS01.ANALOG_IN03	FLOAT	IN		volt	<input type="checkbox"/>
5	BOS01.ANALOG_IN04	FLOAT	IN		volt	<input type="checkbox"/>
6	BOS01.ANALOG_IN05	FLOAT	IN		volt	<input type="checkbox"/>
7	BOS01.ANALOG_IN06	FLOAT	IN		volt	<input type="checkbox"/>
8	BOS01.ANALOG_IN07	FLOAT	IN		volt	<input type="checkbox"/>

#### 4) Analog output module (D/A conversion module)

For the analog output module supported by XG-SIM, refer to the following table.

Module name	Support
XGF-DV4A (voltage type 4ch)	○
XGF-DV8A (current type 8ch)	○
XGF-DC4A (current type 4ch)	○
XGF-DC8A (current type 8ch)	○
XGF-DV4S(insulated voltage output 4ch)	X
XGF-DC4S(insulated current output 4ch)	X

XG-SIM supports the following voltage(current) range and input data type.

Input data type	Output voltage range	Output current range
0 ~ 16000	1 ~ 5V	4 ~ 20mA
-8000 ~ 8000	0 ~ 5V	0 ~ 20mA
1000 ~ 5000	0 ~ 10V	-
0 ~ 10000 (%)	-10 ~ 10V	-

XG-SIM supports the following analog output parameter.

Parameter	Support
Operation channel	○
Output voltage(current) range	○
Input data type	○
Channel output status	X

Digital input may be entered through special module parameter in a program and it is valid only within the range set in the parameter.

#### Notes

- For the details on the parameters of analog output module and the programming, refer to the manual of a module.

## Chapter 16 XG-SIM

An operator may check the analog output that is converted in 'Channel' item of XG-SIM.

Channel	Channel Name	Channel	Input/Output	Channel	Channel Unit	Favorite
1	BOS03.ANALOG_OUT00	FLOAT	OUT		Volt	<input type="checkbox"/>
2	BOS03.ANALOG_OUT01	FLOAT	OUT		Volt	<input type="checkbox"/>
3	BOS03.ANALOG_OUT02	FLOAT	OUT		Volt	<input type="checkbox"/>
4	BOS03.ANALOG_OUT03	FLOAT	OUT		Volt	<input type="checkbox"/>
5	BOS03.ANALOG_OUT04	FLOAT	OUT		Volt	<input type="checkbox"/>
6	BOS03.ANALOG_OUT05	FLOAT	OUT		Volt	<input type="checkbox"/>
7	BOS03.ANALOG_OUT06	FLOAT	OUT		Volt	<input type="checkbox"/>
8	BOS03.ANALOG_OUT07	FLOAT	OUT		Volt	<input type="checkbox"/>

### 5) High speed counter module (HSC module)

For the high speed module supported by XG-SIM, refer to the following table.

Module name	Support
XGF-HO2A (open collector 2ch)	○
XGF-HD2A (open driver 2ch)	○

XG-SIM supports the following counter parameter as follows.

Parameter	Support	Parameter	Support
Counter mode	X	Comparison output 0 max. value	○
Pulse input mode	X	Comparison output 1 min. value	○
Preset	○	Comparison output 1 max. value	○
Ring counter min. value	X	Output status setting	○
Ring counter max. value	X	Additional function mode	X
Comparison output 0 mode	○	Section value (ms)	X
Comparison output 1 mode	○	No. of pulse per rotation	X
Comparison output 0 min. value	○	Frequency display mode	X

#### Notes

- For the details on the parameters of high speed counter module and the programming, refer to the manual of a module.

The current count value may be changed in 'Channel' of XG-SIM window. High speed counter simulator compares the input count value to a value set in parameter and uses it as the comparison output signal.

Channel	Channel Name	Channel	Input/Output	Channel	Channel Unit	Favorite
1	BOS02.CH0_COMPARE_OUPUT0	BOOL	OUT			<input type="checkbox"/>
2	BOS02.CH0_COMPARE_OUPUT1	BOOL	OUT			<input type="checkbox"/>
3	BOS02.CH0_CURRENT_COUNT	DINT	IN		count	<input type="checkbox"/>
4	BOS02.CH1_COMPARE_OUPUT0	BOOL	OUT			<input type="checkbox"/>
5	BOS02.CH1_COMPARE_OUPUT1	BOOL	OUT			<input type="checkbox"/>
6	BOS02.CH1_CURRENT_COUNT	DINT	IN		count	<input type="checkbox"/>

6) Temperature input module (RTD module)

For the temperature input module supported by XG-SIM, refer to the following table.

Module name	Support
XGF-RD4A (4ch)	○
XGF-RD4S (Insulation type 4ch)	X
XGF-TC4S (Insulation type 4ch)	X

XG-SIM supports the following temperature input parameter.

Parameter	Support	Parameter	Support
Operation channel	○	Process warning very upper limit	X
Sensor type	○	Process warning upper limit	X
Temperature unit	○	Process warning lower limit	X
Filter constant	X	Process warning very lower limit	X
Averaging process	X	Process warning hysteresis	X
Average	X	Variance warning setup type	X
Scaling data type	X	Variance warning upper limit	X
Scaling min. value	X	Variance warning lower limit	X
Scaling max. value	X	Variance warning detection cycle	X

Notes

- For the details on the parameters of temperature input module and the programming, refer to the manual of a module.

Temperature input may be changed in 'Channel' of XG-SIM window.

Channel	Channel Name	Channel	Input/Output	Channel	Channel Unit	Favorite
1	BOS03.TEMPERATURE_IN0	FLOAT	IN		°C	<input type="checkbox"/>
2	BOS03.TEMPERATURE_IN1	FLOAT	IN		°C	<input type="checkbox"/>
3	BOS03.TEMPERATURE_IN2	FLOAT	IN		°C	<input type="checkbox"/>
4	BOS03.TEMPERATURE_IN3	FLOAT	IN		°C	<input type="checkbox"/>

## Chapter 16 XG-SIM

### 7) Positioning module (APM module)

#### Notes

XG-SIM supports limited functions among the APM functions that PLC actually supports. APM module in XG-SIM is the module created to help users understand the operation of APM-related functions, so error and program operations may be different with XG-SIM when actually operating PLC. Furthermore, it supports a part of APM related errors, so actual PLC operation may generate different errors, which do not appear in XG-SIM. For the APM function block list supported by XG-SIM, refer to the followings.

For the positioning module supported by XG-SIM, refer to the following table.

Module name	Support
XGF-PO1A (open collector axis 1)	○
XGF-PO2A (open collector axis 2)	○
XGF-PO3A (open collector axis 3)	○
XGF-PD1A (line driver axis 1)	○
XGF-PD2A (line driver axis 2)	○
XGF-PD3A (line driver axis 3)	○

XG-SIM supports the following step data parameter(X/Y/Z axes).

Parameter	Support	Parameter	Support
Coordinate	X	Circular interpolation aux.point [pulse]	X
Control method	○	M code	X
Operation pattern	○	Acc./dec. number	X
Operation method	X	Operation speed	○
Target position [pulse]	○	Dwell time	X
Circular interpolation direction	X	-	-

XG-SIM supports the following operation parameters(X/Y/Z axes).

Parameter type	Item	Support
Basic parameter	Bias speed	○
Extended parameter	External command selection	○
	External command	○
	External stop	○
	External simultaneous start	○
	External speed/position	○

Parameter type	Item	Support
	conversion	
Origin/manual parameter	Origin address	X
	High speed origin return	X
	Low speed origin return	X
Origin/manual parameter	High speed JOG	○
	Low speed JOG	○
	Inching speed	○

The list of exclusive APM function blocks supported by XG-SIM is as follows.

Function block	Command	Support
APM_ORG	Origin return start	X
APM_FLT	Floating origin setting	○
APM_DST	Direct start	○
APM_IST	Indirect start	○
APM_LIN	Linear interpolation start	X
APM_CIN	Circular interpolation start	X
APM_SST	Synchronous start	○
APM_VTP	Speed/position conversion	X
APM_PTV	Position/speed conversion	X
APM_STP	Stop	○
APM_SKP	Skip operation	○
APM_SSP	Position synchronization	X
APM_SSS	Speed synchronization	○
APM_POR	Position override	○
APM_SOR	Speed override	○
APM_PSO	Positioning speed override	X
APM_NMV	Continuous operation	○
APM_INCH	Inching start	○
APM_RTP	Manual operation returning to previous position	○
APM_SNS	Start step no. change	○
APM_SRS	Repeat step no. change	○
APM_MOF	Cancel M code	○
APM_PRS	Current position preset	○
APM_ZONE	ZONE output allowed	○
APM_EPRS	Encoder preset	○

Function block	Command	Support
Teaching function block	-	X
APM_EMG	Emergency stop	○
APM_CLR	Error reset	○
APM_PST	Point operation	X
APM_PWR	Point operation step data setting	X
APM_SRD	Read current status	○
APM_CRD	Read operation status code info	○
APM_ENCRD	Read encoder value	X
APM_JOG	Jog start	X
APM_MPG	Manual pulse operation	X

The APM command error codes generated in XG-SIM are as follows.

Error code	Meaning
151	Operation speed of operation data may not be 0.
221	Direct start command may not be executed during operation.
224	Direct start command may not be executed in an absolute coordinate of which origin is not determined.
231	Indirect start command may not be executed during operation
234	Indirect start command may not be executed in an absolute coordinate of which origin is not determined.
291	Synchronous start command may not be executed during operation.
294	Synchronous start command may not be executed in an absolute coordinate of which origin is not determined.
321	Dec. stop command may not be executed if not operating.
331	Skip command may not be executed if not operating.
355	Main/Aux axis setting of speed synchronous command had an error
356	Main/Aux axis ratio setting of speed synchronous command had an error
361	Position override command may not be executed if not operating
371	Speed override command may not be executed if not operating
391	Continuous operation command may not be executed if not operating
401	Inching command may not be executed during operation
431	Auto operation point return command may not be executed during operation
441	Start step no. change command may not be executed during operation
461	Position teaching command may not be executed during operation
481	Internal emergency stop

**Notes**

- Detail parameter of positioning module is set in a separate APM package, not in XG5000. To set the parameters used in the positioning module, it is necessary to set APM package operation data and save the project file as follows. In addition, APM project file should be located in a same folder in which XG5000 project file is saved.

BxSyZ.apm (x base number, yz slot number, not case-sensitive)

Base	Slot	Project name saved
0	0	B0S0.apm
0	10	B0S10.apm
1	0	B1S0.apm
1	11	B1S11.apm
2	0	B2S0.apm
2	12	B2S12.apm

- For detail settings of APM module parameter, refer to APM package user's manual.

It is possible to check the status of APM module such as the current position in 'Channel' of XG-SIM window.

Channel	Channel Name	Channel	Input/Output	Channel Unit	Channel Unit	Favorite
1	B0S00.XCurrentPosH	UINT	OUT			<input type="checkbox"/>
2	B0S00.XCurrentPosL	UINT	OUT			<input type="checkbox"/>
3	B0S00.XCurrentVelH	UINT	OUT			<input type="checkbox"/>
4	B0S00.XCurrentVelL	UINT	OUT			<input type="checkbox"/>
5	B0S00.YCurrentPosH	UINT	OUT			<input type="checkbox"/>
6	B0S00.YCurrentPosL	UINT	OUT			<input type="checkbox"/>
7	B0S00.YCurrentVelH	UINT	OUT			<input type="checkbox"/>
8	B0S00.YCurrentVelL	UINT	OUT			<input type="checkbox"/>
9	B0S00.ZCurrentPosH	UINT	OUT			<input type="checkbox"/>
10	B0S00.ZCurrentPosL	UINT	OUT			<input type="checkbox"/>
11	B0S00.ZCurrentVelH	UINT	OUT			<input type="checkbox"/>
12	B0S00.ZCurrentVelL	UINT	OUT			<input type="checkbox"/>

**Notes**

- The channels of positioning module have the following meaning. (i.e.: based on X-axis)

Channel name	Meaning
XCurrentPosH	High 16 bits in the current position value of X-axis
XCurrentPosL	Low 16 bits in the current position value of X-axis
XCurrentVelH	High 16 bits of the current speed value of X-axis
XCurrentVelL	Low 16 bits of the current speed value of X-axis

### 16.3 Restrictions

Comparing to actual PLC, XG-SIM have the following restrictions.

#### 16.3.1 Watchdog Timer

Watchdog timer is installed in XGI PLC to prevent a created PLC program from working abnormally. On the other hand, XG-SIM executes scan at lower speed than actual XGI series PLC, so the watchdog timer set in the basic parameter does not work properly.

#### 16.3.2 Communication module

XG-SIM does not provide any COM functions. Therefore, the following function blocks created by a program are saved as the internal data of XG-SIM and they are not actually used for communication.

Class	Name	Function
Station No. setting	P2PSN	Designate the station no. of communication counterpart
Reading area designation(BOOL)	P2PRD_BOOL	Designate the bit data reading area
Reading area designation(BYTE)	P2PRD_BYTE	Designate the byte data reading area
Reading area designation (WORD)	P2PRD_WORD	Designate the word data reading area
Reading area designation (DWORD)	P2PRD_DWORD	Designate the double word reading area
Reading area designation (LWORD)	P2PRD_LWORD	Designate the long word data reading area
Writing area designation (BOOL)	P2PWR_BOOL	Designate the bit data writing area
Writing area designation (BYTE)	P2PWR_BYTE	Designate the byte data writing area
Writing area designation (WORD)	P2PWR_WORD	Designate the word data writing area
Writing area designation (DWORD)	P2PWR_DWORD	Designate the double word data writing area
Writing area designation (LWORD)	P2PWR_LWORD	Designate the long word data writing area



## Chapter 17 ST Edition

ST based on character is program language and conforms to IEC 61131-3.

### 17.1 Writing ST program

Scan program, user function/FB, SFC can be written by ST language.

#### 17.1.1 Adding Scan Program

[Step]

1. Select Scan Program in the project window.

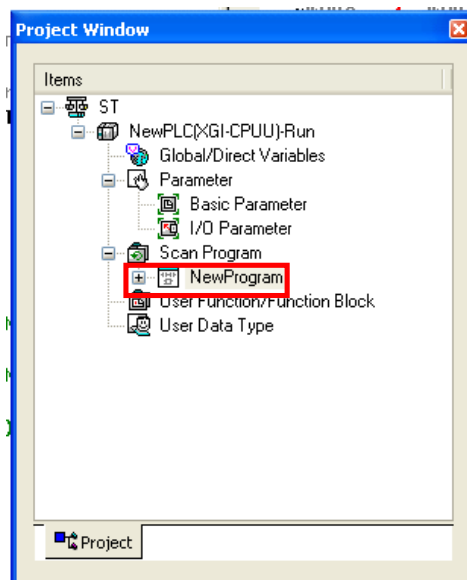

2. Select [Project] - [Add item] - [Program].

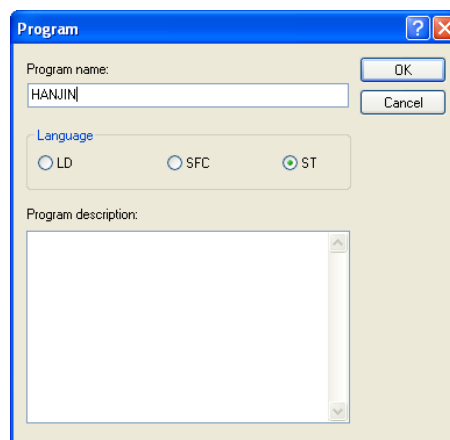

3. Input program name and description. Select ST in Language.

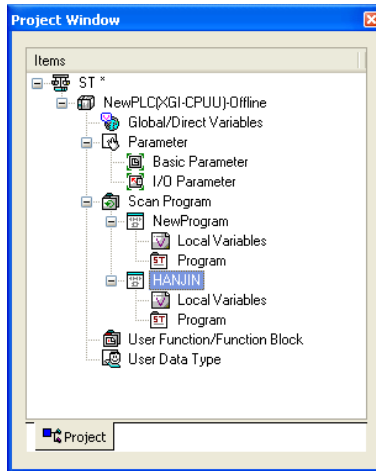

### 17.1.2 Adding User Function/Function Block

[Step]

1. Select User Function/Function Block in the project window.

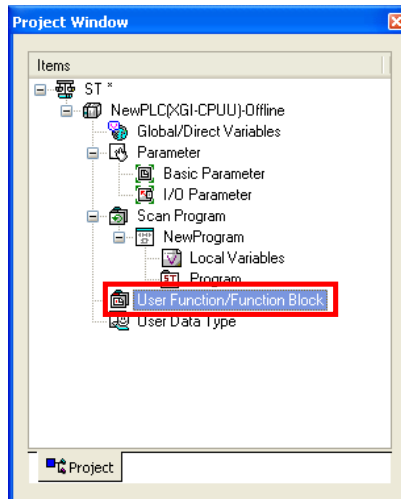

2. Select [Project] - [Add Item] – [Function] or [Function Block].

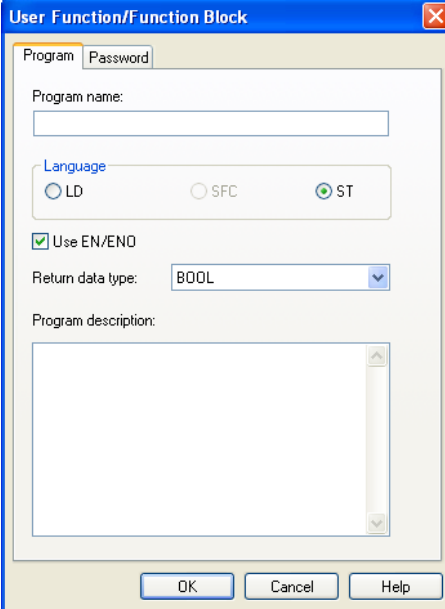

The screenshot shows the 'User Function/Function Block' dialog box with the 'Program' tab selected. The 'Program name' field is empty. The 'Language' section has three radio buttons: LD, SFC, and ST. The ST radio button is selected. The 'Use EN/END' checkbox is checked. The 'Return data type' dropdown menu is set to 'BOOL'. The 'Program description' field is empty. At the bottom, there are three buttons: 'OK', 'Cancel', and 'Help'.

3. Input name and description. Select ST in Language. In case of Function, select Return data type.

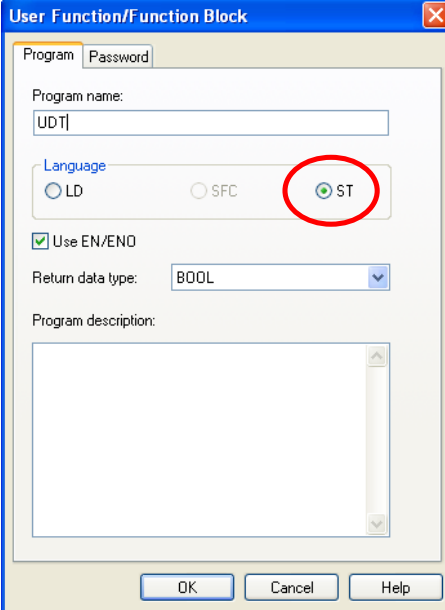

The screenshot shows the 'User Function/Function Block' dialog box with the 'Program' tab selected. The 'Program name' field contains the text 'UDT'. The 'Language' section has three radio buttons: LD, SFC, and ST. The ST radio button is selected and is circled in red. The 'Use EN/END' checkbox is checked. The 'Return data type' dropdown menu is set to 'BOOL'. The 'Program description' field is empty. At the bottom, there are three buttons: 'OK', 'Cancel', and 'Help'.

### 17.1.3 Adding SFC transition, action

[Step for adding transition]

1. Select transition in which the user wants to input program in SFC program.

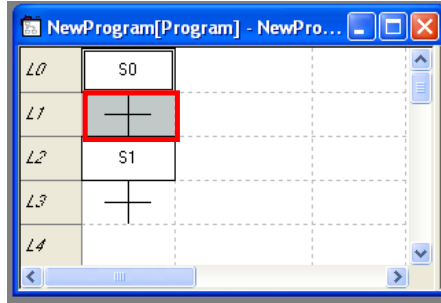

2. After selecting transition, double-click it or press 'Enter' .
3. Input name and comment. Select Program in Type.

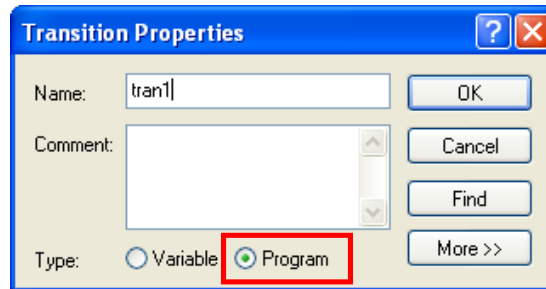

4. Select ST as Language in Add Program window.

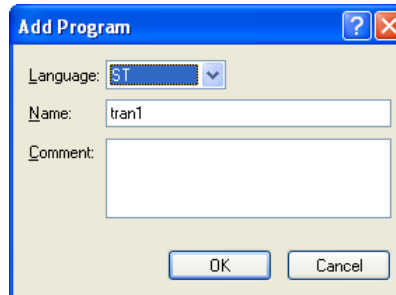

[Step for adding action]

1. Input Name and Comment and select Program in Type in the Action Properties window.

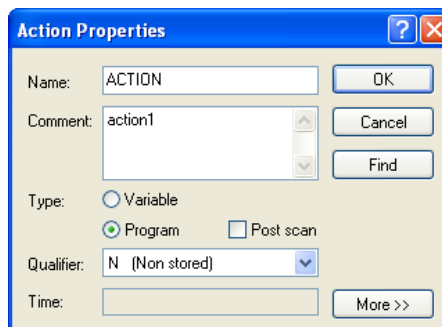

2. Select ST as Language in the Add Program window.

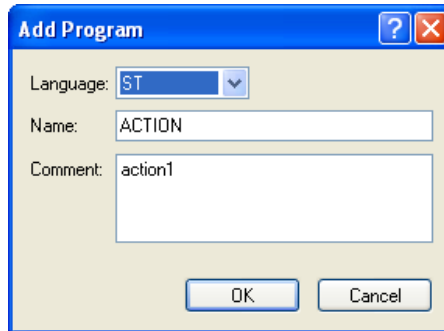

### 17.2 Limit

When editing ST language, there is the limit as described below.

Item	Content	Limit
Max. no. of character in one line	Max. no. of character in one line is 2,048 for English and 1,024 for Korean.	2,048

#### Note

1. Only one scan program is available in one scan program.
2. Language of User Function/Function Block, SFC transition and action can be different with language of scan program.
3. Program can't be converted into program written other languages.

### 17.3 Editing Program

#### 17.3.1 Shortcut key

The followings are shortcut key.

The user can change shortcut key in [Tools] - [Shortcut key Settings].

Action	Shortcut key	Description
Copy	Ctrl + C	Copies selected character string.
Paste	Ctrl + V	Pastes copied character string.
Delete	Del	Deletes selected character string.
Cut	Ctrl + X	Copies selected character string and deletes it.
Undo	Ctrl + Z	Cancels edition.
Redo	Ctrl + Y	Cancels Redo action.
Select All	Ctrl + A	Selects all character strings.

The followings are shortcut key about movement. The user can't change the following shortcut keys.

Shortcut key	Description
Home	Goes to start of line.
Ctrl + Home	Goes to start of program.
→	Moves cursor to right one space.
←	Moves cursor to left one space.
↑	Moves cursor to upper line.

Shortcut key	Description
↓	Moves cursor to lower line.
End	Goes to end of line.
Page up	Goes to upper one page.
Page down	Goes to lower one page.
Ctrl + End	Goes to end of edited line.
Ctrl + →	Goes to start of next word.
Ctrl + ←	Goes to start of previous word.
Ctrl + Del	Deletes by start of next word.
Ctrl + BS	Deletes by start of current word.
Shift + Move	Selects from current cursor location to location to move.

**Note**

1. The described shortcut key is based on default of XG5000
2. For user defined- shortcut key, refer to chapter 2.4

**17.3.2 Copy/Paste**

Copies selected character string into clipboard and pastes it.

[Step]

1. Select the character string to copy.

```

22: // SETTING ERROR FLAG!
23: IF LWORD_TMP <> LINT_VAL THEN ERROR := TRUE;
24: ELSE ERROR := FALSE;
25: END_IF;
26:
27: DWORD_LOWER := LWORD_TO_DWORD(LWORD_TMP AND 16#00000000FFFFFFFF);
28: DWORD_HIGHER := LWORD_TO_DWORD(SHR(LWORD_TMP AND 16#FFFFFFFF00000000, 32));
29:

```

2. Select [Edit] - [Copy].
3. Move to location to paste.

```

22: // SETTING ERROR FLAG!
23: IF LWORD_TMP <> LINT_VAL THEN ERROR := TRUE;
24: ELSE ERROR := FALSE;
25: END_IF;
26:
27: DWORD_LOWER := LWORD_TO_DWORD(LWORD_TMP AND 16#00000000FFFFFFFF);
28: DWORD_HIGHER := LWORD_TO_DWORD(SHR(LWORD_TMP AND 16#FFFFFFFF00000000, 32));
29: |
30: END_IF;

```

4. Select [Edit] – [Paste].

```
22 // SETTING ERROR FLAG!  
23 IF LWORD_TMP <> LINT_VAL THEN ERROR := TRUE;  
24 ELSE ERROR := FALSE;  
25 END_IF;  
26  
27 DWORD_LOWER := LWORD_TO_DWORD(LWORD_TMP AND 16#00000000FFFFFFFF);  
28 DWORD_HIGHER := LWORD_TO_DWORD(SHR(LWORD_TMP AND 16#FFFFFFFF00000000, 32));  
29 LWORD_TO_DWORD  
30 END_IF;
```

### Note

1. Clipboard: memory area of PC to save temporary information.
2. When parting, if the user selects the area, the character string is overwritten and if the user doesn't select the area, it is inserted.
3. Only text is pasted.

### 17.3.3 Undo/Redo

Undo cancels edition and Redo cancels Undo action.

[Step]

1. After executing Paste, selects [Edit] – [Undo].

=> Pasted contents are deleted.

```
22 // SETTING ERROR FLAG!  
23 IF LWORD_TMP <> LINT_VAL THEN ERROR := TRUE;  
24 ELSE ERROR := FALSE;  
25 END_IF;  
26  
27 DWORD_LOWER := LWORD_TO_DWORD(LWORD_TMP AND 16#00000000FFFFFFFF);  
28 DWORD_HIGHER := LWORD_TO_DWORD(SHR(LWORD_TMP AND 16#FFFFFFFF00000000, 32));  
29 |  
30 END_IF;
```

2. Select [Edit] – [Redo].

=> Paste action is executed again.

```
22 // SETTING ERROR FLAG!  
23 IF LWORD_TMP <> LINT_VAL THEN ERROR := TRUE;  
24 ELSE ERROR := FALSE;  
25 END_IF;  
26  
27 DWORD_LOWER := LWORD_TO_DWORD(LWORD_TMP AND 16#00000000FFFFFFFF);  
28 DWORD_HIGHER := LWORD_TO_DWORD(SHR(LWORD_TMP AND 16#FFFFFFFF00000000, 32));  
29 LWORD_TO_DWORD  
30 END_IF;
```

### 17.3.4 Adding/Selecting variable

Inputs variable at the selected location.

[Step]

1. After moving the cursor, select [Edit] – [Select/Add Variable].



[Dialog box]

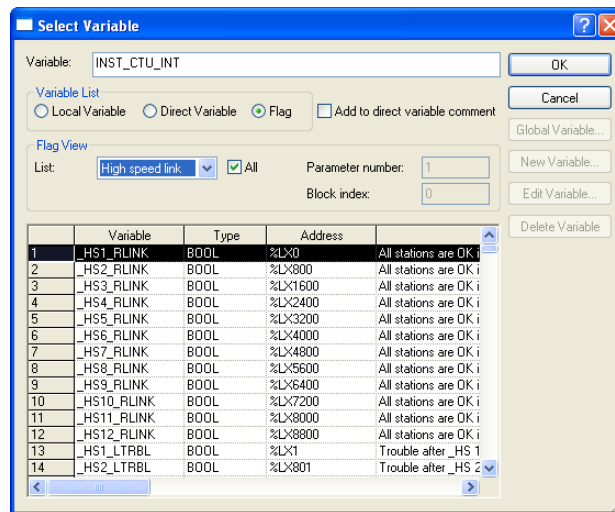

[Description of dialog box]

- a. Variable: inputs name of direct variable or declared variable. If the inputted character string is variable type and isn't registered as variable, Variable Addition/Edit dialog box shows.
- b. Local variable: displays the declared local variable list.
- c. Direct variable: displays direct variable comment.
- d. Flag: displays flag in the list. Type of flag list can be selected in List.
- e. List: displays type of flag list. There is system/High speed link/P2P/PID.
- f. All: selects whether only flags related with Parameter number, Block index are displayed or not.
- g. Parameter number: inputs number to sort flags. 0~12 for high speed link, 0~12 for P2P, 0~63 for PID.
- h. Block index: inputs number to sort flags. 0~127 for high speed link, 0~63 for P2P.
- i. Global Variable: displays global variable list. It is available to register as EXTERNAL variable.
- j. New Variable: recalls dialog box to add variable to local variable list.
- k. Edit Variable: recalls dialog box to edit the selected variable.
- l. Delete Variable: deletes the selected local variable from local variable list.
- m. OK: saves inputted or selected items and closes dialog box.
- n. Cancel: closes the dialog box.

[Dialog box]

The dialog box is titled "Variable Addition/Edit". It features a blue title bar with a help icon and a close button. The main area is light beige and contains the following elements:

- Variable:** A text input field containing "kaka" and an "OK" button.
- Data Type:** A dropdown menu showing "BOOL" and a "Cancel" button.
- Variable Kind:** A dropdown menu showing "VAR".
- Address:** A text input field and a "Settings..." button.
- Initial Value:** A text input field and an "Initialization..." button.
- Trigger:** A dropdown menu and a "Retain" checkbox.
- Description:** A large, empty text area.

[Description of dialog box]

- a. Variable: inputs variable name..
- b. Data Type: selects data type of variable.
- c. Variable Kind: selects Variable Kind of variable.
- d. Address: assigns direct address about variable.
- e. Initial Value: inputs initial value of variable.
- f. Trigger: inputs trigger status about variable.
- g. Retain: inputs Retain status about variable.
- h. Description: inputs Description about variable.

2. Inserts variable at the cursor location

### Note

1. If the user selects [Select/Add Variable] with cursor placed in the empty area, the user can add new variable.
2. If the user selects [Select/Add Variable] after selecting character string, that character string is replaced into variable.

### 17.3.5 Inserting Function/Function Block

Inserts Function/Function Block at the cursor location.

[Step]

1. Move the cursor to insert.

```

22 // SETTING ERROR FLAG!
23 IF LWORD_TMP <> LINT_VAL THEN ERROR := TRUE;
24 ELSE ERROR := FALSE;
25 END_IF;
26
27 DWORD_LOWER := LWORD_TO_DWORD(LWORD_TMP AND 16#00000000FFFFFFFF);
28 DWORD_HIGHER := LWORD_TO_DWORD(SHR(LWORD_TMP AND 16#FFFFFFFF00000000, 32));
29 |
30 END_IF;

```

2. Select [Edit] – [Function/Function Block].

[Dialog box]

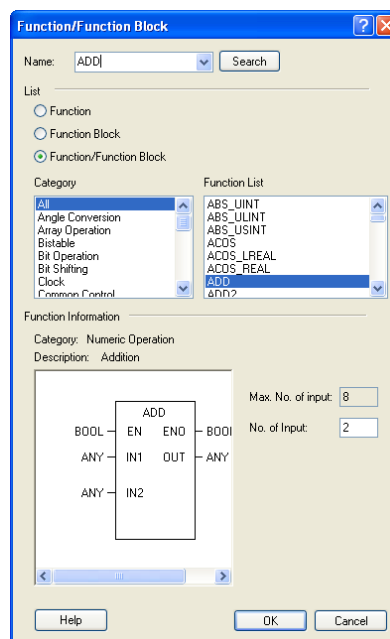

[Description of dialog box]

- a. Name: inputs name of Function (Block) to use.
- b. Search: searches Function (Block) about the inputted name.
- c. List: it is used to sort Function, Function Block .
- d. Category: indicates category of Function (Block).
- e. Function List: displays list of Function (Block) in the selected category.
- f. Function Information: displays information of Function (Block). In case of Function, it is available to set properties about input parameter. In case of Function Block, it is available to set instance name and instance class.
- g. OK: applies them and closes window.
- h. Cancel: closes window without application.

3. Function/Function Block is inserted.

```
22: // SETTING ERROR FLAG!
23: IF LWORD_TMP <> LINT_VAL THEN ERROR := TRUE;
24: ELSE ERROR := FALSE;
25: END_IF;
26:
27: DWORD_LOWER := LWORD_TO_DWORD(LWORD_TMP AND 16#00000000FFFFFFFF);
28: DWORD_HIGHER := LWORD_TO_DWORD(SHR(LWORD_TMP AND 16#FFFFFFFF00000000, 32));
29: ADD( ANY_IN1, ANY_IN2, ANY_IN3, ANY_IN4, ANY_IN5, ANY_IN6, ANY_IN7, ANY_IN8 )
30: END_IF;
```

### Note

-I/O parameters of function/function block are not inserted automatically. The user should edit them additionally.

## 17.4 Viewing Program

Describes about display properties in the ST program.

### 17.4.1 ST option

Description about dialog box of option in the ST program.

[Step]

1. Select [Tools]-[Options].
2. Select ST.

[Dialog box]

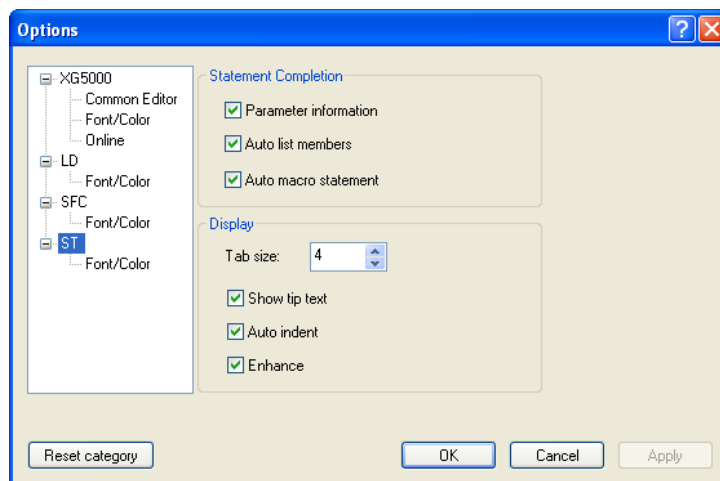

[Description of dialog box]

- a. Parameter information: when inserting Function//FB, example text of IO parameter is added.
- b. Auto list members: when inserting character string by keyboard, variable or Function/FB starting with same character are displayed.
- c. Auto macro statement: when inserting the control text of ST (IF, WHILE, SWITCH), control text is completed according to ST grammar
- d. Tap size: inputs tap size.
- e. Show tip text: when cursor is on the character string in ST program, description of character string is displayed.
- f. Auto indent: when changing line with ENTER, indent is applied automatically with same tap size of previous line
- g. Enhance: character string used in ST program is displayed with various colors according to variable, comment, Function (Block)

### 17.4.2 Font/Color

Available to designate font or color in the ST program.

#### 1) Font

[Step]

1. Select [Tools]-[Options].
2. Select ST Font/Color.
3. Change Font.

#### Note

1. The user can't change the character size
2. Default font is "Fixedsys".
3. For more details, refer to chapter 2.6

#### 2) Color

[Step]

1. Select [Tools] - [Options].
2. Select ST font/color.
3. Change color.

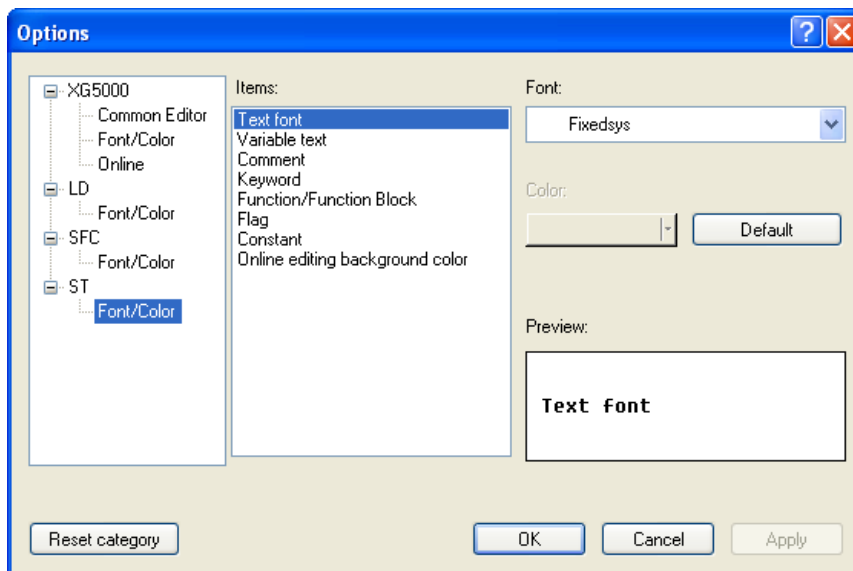

#### Note

1. For more details, refer to chapter 2.6.

### 17.4.3 Zoom

ST program doesn't support Zoom function.

### 17.4.4 Tap

When using Tap, Tap size is designated.

[Step]

1. Select [Tools] – [Options].
2. Select ST.
3. Change Tap size.

```

1
2 CLOCK_SOURCE := _T1S;
3
4 // LEFT rotate, FIND transition
5 IF (* _T1S XOR *) 0 = PREV_STATUS THEN
6 //IF (* _T1S XOR *) 0 = PREV_STATUS AND (PREV_STATUS XOR CLOCK_SOURCE) THEN
7   LINT_VAL := LINT_VAL + 1;
8   %ML0 := %ML0 + 1;
9
10  FOR IDX := 0 TO MAX_VALUE - 1 DO
11    mask := SHL(LWORD#1, IDX);
12    LONG_ARRAY[IDX, IDX] := mask = (LINT_VAL AND mask);
13  END_FOR;
14
-----

```

[Tap size 4 screen]

```

1
2 CLOCK_SOURCE := _T1S;
3
4 // LEFT rotate, FIND transition
5 IF (* _T1S XOR *) 0 = PREV_STATUS THEN
6 //IF (* _T1S XOR *) 0 = PREV_STATUS AND (PREV_STATUS XOR CLOCK_SOURCE) THEN
7   LINT_VAL := LINT_VAL + 1;
8   %ML0 := %ML0 + 1;
9
10  FOR IDX := 0 TO MAX_VALUE - 1 DO
11    mask := SHL(LWORD#1, IDX);
12    LONG_ARRAY[IDX, IDX] := mask = (LINT_VAL AND mask);
13  END_FOR;
14
-----

```

[Tap size 8 screen]

#### Note

1. Default tap size is 4.
2. Range of tap size is 1~100.

### 17.4.5 Showing line numbers

Shows/hides line numbers in the ST program

[Step]

1. Select [Tools] – [Options].
2. Select XG5000 Common Editor.
3. Check 'Show line numbers' .



## 17.5 Additional Edition Function

Describes additional edition function for convenient.

### 17.5.1 Book mark

The user can set bookmark and go there easily.

#### 1) Setting book mark

[Step]

1. Move the cursor to set bookmark.

```

1
2 CLOCK_SOURCE := _T1S;
3
4 // LEFT rotate, FIND transition
5 IF (* _T1S XOR *) 0 = PREV_STATUS THEN
6 //IF (* _T1S XOR *) 0 = PREV_STATUS AND (PREV_STATUS XOR CLOCK_SOURCE) THEN
7     LINT_VAL := LINT_VAL + 1;
8     %ML0 := %ML0 + 1;
9
10  FOR IDX := 0 TO MAX_VALUE - 1 DO
11     mask := SHL(1, IDX);
12     LONG_ARRAY[IDX] := mask = (LINT_VAL AND mask);
13  END_FOR;
14

```

2. Select [Edit] – [Bookmark] – [Set/Remove].

```

1
2 CLOCK_SOURCE := _T1S;
3
4 // LEFT rotate, FIND transition
5 IF (* _T1S XOR *) 0 = PREV_STATUS THEN
6 //IF (* _T1S XOR *) 0 = PREV_STATUS AND (PREV_STATUS XOR CLOCK_SOURCE) THEN
7     LINT_VAL := LINT_VAL + 1;
8     %ML0 := %ML0 + 1;
9
10  FOR IDX := 0 TO MAX_VALUE - 1 DO
11     mask := SHL(1, IDX);
12     LONG_ARRAY[IDX] := mask = (LINT_VAL AND mask);
13  END_FOR;
14

```

### 2) Removing bookmark

[Step]

1. Move the cursor to remove bookmark.

```

1
2 CLOCK_SOURCE := _T1S;
3
4 // LEFT rotate, FIND transition
5 IF (* _T1S XOR *) 0 = PREV_STATUS THEN
6 //IF (* _T1S XOR *) 0 = PREV_STATUS AND (PREV_STATUS XOR CLOCK_SOURCE) THEN
7     LINT_VAL := LINT_VAL + 1;
8     %ML0 := %ML0 + 1;
9
10  FOR IDX := 0 TO MAX_VALUE - 1 DO
11     mask := SHL(1, IDX);
12     LONG_ARRAY[IDX] := mask = (LINT_VAL AND mask);
13  END_FOR;
14

```

2. Select [Edit] – [Bookmark] – [Set/Remove]

```

1
2 CLOCK_SOURCE := _T1S;
3
4 // LEFT rotate, FIND transition
5 IF (* _T1S XOR *) 0 = PREV_STATUS THEN
6 //IF (* _T1S XOR *) 0 = PREV_STATUS AND (PREV_STATUS XOR CLOCK_SOURCE) THEN
7     LINT_VAL := LINT_VAL + 1;
8     %ML0 := %ML0 + 1;
9
10  FOR IDX := 0 TO MAX_VALUE - 1 DO
11     mask := SHL(1, IDX);
12     LONG_ARRAY[IDX] := mask = (LINT_VAL AND mask);
13  END_FOR;
14

```

### 3) Removing all bookmark

[Step]

1. Select [Edit] – [Bookmark] – [Remove All].

```

1
2 CLOCK_SOURCE := _T1S;
3
4 // LEFT rotate, FIND transition
5 IF (* _T1S XOR *) 0 = PREV_STATUS THEN
6 //IF (* _T1S XOR *) 0 = PREV_STATUS AND (PREV_STATUS XOR CLOCK_SOURCE) THEN
7     LINT_VAL := LINT_VAL + 1;
8     %ML0 := %ML0 + 1;
9
10  FOR IDX := 0 TO MAX_VALUE - 1 DO
11     mask := SHL(1, IDX);
12     LONG_ARRAY[IDX] := mask = (LINT_VAL AND mask);
13  END_FOR;
14
15  LWORD_TMP := 0;
16  FOR IDX := 0 TO MAX_VALUE - 1 DO
17     //MASK := MASK OR SHL(BOOL_TO_LWORD(LONG_ARRAY[IDX]), IDX);
18     mask := SHL(BOOL_TO_LWORD(LONG_ARRAY[IDX]), IDX);
19     LWORD_TMP := mask OR LWORD_TMP;
20  END_FOR;

```

## 4) Going to previous bookmark

[Step]

1. Select [Edit] – [Bookmark] – [Previous Bookmark].

## 5) Going to next bookmark

[Step]

1. Select [Edit] – [Bookmark] – [Next Bookmark].

**Note**

1. Bookmark is set by line unit
2. Undo/Redo can't cancel action about bookmark.

**17.5.2 Selection from character string list**

When inputting character string, character string starting with same character string is displayed and the user selects it conveniently.

[Step]

1. Input character string by keyboard.

```

17 INST_CTU_INT(CU:=_T10S(*BOOL*), R:=temp(*BOOL*), PU:=10(*INT*), Q=>temp(*BOOL*), CU=>re1
18 IF relay=0 THEN
19     relay:=1;
20 END_IF;
21

```

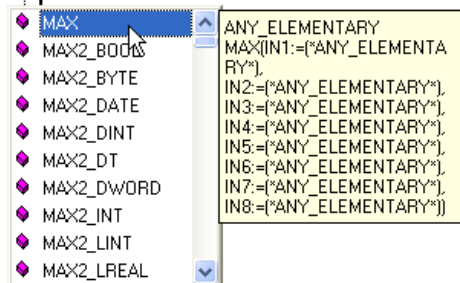

2. Select character string from list.

```

17 INST_CTU_INT(CU:=_T10S(*BOOL*), R:=temp(*BOOL*), PU:=10(*INT*), Q=>temp(*BOOL*), CU=>re1
18 IF relay=0 THEN
19     relay:=1;
20 END_IF;
21

```

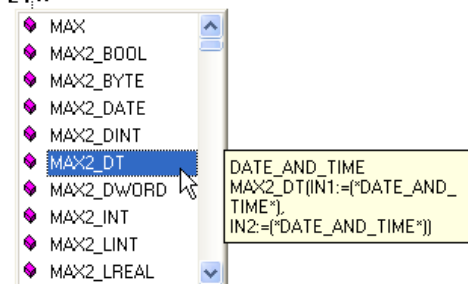







3. Press 'Enter' or double-click.

```

17 INST_CTU_INT(CU:=_T10S(*BOOL*), R:=temp(*BOOL*), PV:=10(*INT*), Q=>temp(*BOOL*), CU=>relay(
18 IF relay=0 THEN
19     relay:=1;
20 END_IF;
21 MAX2_DT
    
```

### Note

Description of character string list bit map

1.  : ST language key word (IF, CASE WHILE etc.)
2.  : Variable name
3.  : Flag variable name
4.  : Function name
5.  : Function block instance name
6.  : User defined-function name
7.  : User defined-function block instance name





### 17.5.3 Selecting member variable from character string list

It is used to select member variable from character string list by name of FB or user data type instance.

1. Input '.' after name of FB or user data type instance.

Ex.) In case that instance name of TON is TON\_Inst

```

5 TON_Inst(IN:=%MX34(*BOOL*), PT:=T#5S(*TIME*), Q=>%MX7(*BOOL*), ET=>%MD124(*TIME*));
6 TON_Inst.]
7 IF %MX  TON_Inst.ET
8     %M:  TON_Inst.IN
9 ELSE  TON_Inst.PT
10     %M:  TON_Inst.Q
11 END_IF;
12
13 IF _T1S = 1 THEN
14     (*ARRAY[0..-1]_OF_ANY_ELEMENTARY*)%QW0.1.0:=MOVE(IN:=WORD#16#FFFF(*ARRAY[0..-1]
    
```

- Select member variable to input.

```

5 TON_Inst(IN:=%MX34(*BOOL*), PT:=T#5S(*TIME*), Q=>%MX7(*BOOL*), ET=>%MD124(*TIME*)
6 TON_Inst.
7 IF %MX
8   %M:
9 ELSE
10  %M:
11 END_IF
12
13 IF _T1S =1 THEN
14   (*ARRAY[0..-1]_OF_ANY_ELEMENTARY*)%QW0.1.0:=MOVE(IN:=WORD#16#FFF(*ARRAY[0.

```

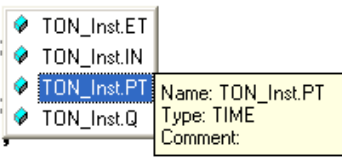

- Press 'Enter' or double-click.

```

5 TON_Inst(IN:=%MX34(*BOOL*), PT:=T#5S(*TIME*), Q=>%MX7(*BOOL*), ET=>%MD124(*TIME*)
6 TON_Inst.PT]
7 IF %MX0=1 THEN
8   %MX8:=0;
9 ELSE
10  %MX8:=1;
11 END_IF;
12
13 IF _T1S =1 THEN

```

### 17.5.4 Setting/Removing Block Mask

Sets or removes the Block Mask area. The Block Mask area is not executed. Block Mask area is indicated by symbol “(“ and “)“.

- Setting Block Mask

- Select area to set Block Mask.

```

1
2 CLOCK_SOURCE := _T1S;
3
4 // LEFT rotate, FIND transition
5 IF (* _T1S XOR *) 0 = PREV_STATUS THEN
6 //IF (* _T1S XOR *) 0 = PREV_STATUS AND (PREV_STATUS XOR CLOCK_SOURCE) THEN
7   LINT_VAL := LINT_VAL + 1;
8   %ML0 := %ML0 + 1;
9
10  FOR IDX := 0 TO MAX_VALUE - 1 DO
11   mask := SHL(1, IDX);
12   LONG_ARRAY[IDX] := mask = (LINT_VAL AND mask);
13  END_FOR;
14
15  LWORD_TMP := 0;
16  FOR IDX := 0 TO MAX_VALUE - 1 DO
17   //MASK := MASK OR SHL(BOOL_TO_LWORD(LONG_ARRAY[IDX]), IDX);
18   mask := SHL(BOOL_TO_LWORD(LONG_ARRAY[IDX]), IDX);
19   LWORD_TMP := mask OR LWORD_TMP;
20  END_FOR;

```

### 2. Select [Edit] – [Set/Remove Block Mask].

```

1
2 CLOCK_SOURCE := _T1S;
3
4 // LEFT rotate, FIND transition
5 IF (* _T1S XOR *) 0 = PREV_STATUS THEN
6 //IF (* _T1S XOR *) 0 = PREV_STATUS AND (PREV_STATUS XOR CLOCK_SOURCE) THEN
7     LINT_VAL := LINT_VAL + 1;
8     %ML0 := %ML0 + 1;
9
10 (* FOR IDX := 0 TO MAX_VALUE - 1 DO
11     mask := SHL(1, IDX);
12     LONG_ARRAY[IDX] := mask = (LINT_VAL AND mask);
13 END_FOR;
14 *)
15 LWORD_TMP := 0;
16 FOR IDX := 0 TO MAX_VALUE - 1 DO
17     //MASK := MASK OR SHL(BOOL_TO_LWORD(LONG_ARRAY[IDX]), IDX);
18     mask := SHL(BOOL_TO_LWORD(LONG_ARRAY[IDX]), IDX);
19     LWORD_TMP := mask OR LWORD_TMP;
20 END_FOR;

```

### 2) Removing Block Mask

#### 1. Select area in which Block Mask is already set.

```

1
2 CLOCK_SOURCE := _T1S;
3
4 // LEFT rotate, FIND transition
5 IF (* _T1S XOR *) 0 = PREV_STATUS THEN
6 //IF (* _T1S XOR *) 0 = PREV_STATUS AND (PREV_STATUS XOR CLOCK_SOURCE) THEN
7     LINT_VAL := LINT_VAL + 1;
8     %ML0 := %ML0 + 1;
9
10 (* FOR IDX := 0 TO MAX_VALUE - 1 DO
11     mask := SHL(1, IDX);
12     LONG_ARRAY[IDX] := mask = (LINT_VAL AND mask);
13 END_FOR;
14 *)
15 LWORD_TMP := 0;
16 FOR IDX := 0 TO MAX_VALUE - 1 DO
17     //MASK := MASK OR SHL(BOOL_TO_LWORD(LONG_ARRAY[IDX]), IDX);
18     mask := SHL(BOOL_TO_LWORD(LONG_ARRAY[IDX]), IDX);
19     LWORD_TMP := mask OR LWORD_TMP;
20 END_FOR;

```

2. Select [Edit] – [Set/Remove Block Mask].

```

1
2 CLOCK_SOURCE := _T1S;
3
4 // LEFT rotate, FIND transition
5 IF (* _T1S XOR *) 0 = PREV_STATUS THEN
6 //IF (* _T1S XOR *) 0 = PREV_STATUS AND (PREV_STATUS XOR CLOCK_SOURCE) THEN
7     LINT_VAL := LINT_VAL + 1;
8     %ML0 := %ML0 + 1;
9
10 (* FOR IDX := 0 TO MAX_VALUE - 1 DO
11     mask := SHL(1, IDX);
12     LONG_ARRAY[IDX] := mask = (LINT_VAL AND mask);
13 END_FOR;
14 *)
15 LWORD_TMP := 0;
16 FOR IDX := 0 TO MAX_VALUE - 1 DO
17     //MASK := MASK OR SHL(BOOL_TO_LWORD(LONG_ARRAY[IDX]), IDX);
18     mask := SHL(BOOL_TO_LWORD(LONG_ARRAY[IDX]), IDX);
19     LWORD_TMP := mask OR LWORD_TMP;
20 END_FOR;

```

### 17.5.5 Setting/Removing Line Block Mask

Selected line is not executed.

Symbol"/" is used to set Line Block Mask.

1) Setting line block mask

1. Select area to set line block mask.

```

1
2 CLOCK_SOURCE := _T1S;
3
4 // LEFT rotate, FIND transition
5 IF (* _T1S XOR *) 0 = PREV_STATUS THEN
6 //IF (* _T1S XOR *) 0 = PREV_STATUS AND (PREV_STATUS XOR CLOCK_SOURCE) THEN
7     LINT_VAL := LINT_VAL + 1;
8     %ML0 := %ML0 + 1;
9
10 FOR IDX := 0 TO MAX_VALUE - 1 DO
11     mask := SHL(1, IDX);
12     LONG_ARRAY[IDX] := mask = (LINT_VAL AND mask);
13 END_FOR;
14
15 LWORD_TMP := 0;
16 FOR IDX := 0 TO MAX_VALUE - 1 DO
17     //MASK := MASK OR SHL(BOOL_TO_LWORD(LONG_ARRAY[IDX]), IDX);
18     mask := SHL(BOOL_TO_LWORD(LONG_ARRAY[IDX]), IDX);
19     LWORD_TMP := mask OR LWORD_TMP;
20 END_FOR;

```

### 2. Select [Edit] – [Set/Remove Line Block Mask].

```
1
2 CLOCK_SOURCE := _T1S;
3
4 // LEFT rotate, FIND transition
5 IF (*_T1S XOR *) 0 = PREV_STATUS THEN
6 //IF (*_T1S XOR *) 0 = PREV_STATUS AND (PREV_STATUS XOR CLOCK_SOURCE) THEN
7     LINT_VAL := LINT_VAL + 1;
8     %ML0 := %ML0 + 1;
9
10 // FOR IDX := 0 TO MAX_VALUE - 1 DO
11 //     mask := SHL(1, IDX);
12 //     LONG_ARRAY[IDX] := mask = (LINT_VAL AND mask);
13 // END_FOR;
14
15 LWORD_TMP := 0;
16 FOR IDX := 0 TO MAX_VALUE - 1 DO
17     //MASK := MASK OR SHL(BOOL_TO_LWORD(LONG_ARRAY[IDX]), IDX);
18     mask := SHL(BOOL_TO_LWORD(LONG_ARRAY[IDX]), IDX);
19     LWORD_TMP := mask OR LWORD_TMP;
20 END_FOR;
```

### 2) Removing line block mask

#### 1. Select area to remove line block mask.

```
1
2 CLOCK_SOURCE := _T1S;
3
4 // LEFT rotate, FIND transition
5 IF (*_T1S XOR *) 0 = PREV_STATUS THEN
6 //IF (*_T1S XOR *) 0 = PREV_STATUS AND (PREV_STATUS XOR CLOCK_SOURCE) THEN
7     LINT_VAL := LINT_VAL + 1;
8     %ML0 := %ML0 + 1;
9
10 // FOR IDX := 0 TO MAX_VALUE - 1 DO
11 //     mask := SHL(1, IDX);
12 //     LONG_ARRAY[IDX] := mask = (LINT_VAL AND mask);
13 // END_FOR;
14
15 LWORD_TMP := 0;
16 FOR IDX := 0 TO MAX_VALUE - 1 DO
17     //MASK := MASK OR SHL(BOOL_TO_LWORD(LONG_ARRAY[IDX]), IDX);
18     mask := SHL(BOOL_TO_LWORD(LONG_ARRAY[IDX]), IDX);
19     LWORD_TMP := mask OR LWORD_TMP;
20 END_FOR;
```



2. Select [Edit] – [Set/Remove Line Block Mask].

```

1
2 CLOCK_SOURCE := _T1S;
3
4 // LEFT rotate, FIND transition
5 IF (*_T1S XOR *) 0 = PREV_STATUS THEN
6 //IF (*_T1S XOR *) 0 = PREV_STATUS AND (PREV_STATUS XOR CLOCK_SOURCE) THEN
7   LINT_VAL := LINT_VAL + 1;
8   %ML0 := %ML0 + 1;
9
10  FOR IDX := 0 TO MAX_VALUE - 1 DO
11    mask := SHL(1, IDX);
12    // LONG_ARRAY[IDX] := mask = (LINT_VAL AND mask);
13  // END_FOR;
14
15  LWORD_TMP := 0;
16  FOR IDX := 0 TO MAX_VALUE - 1 DO
17    //MASK := MASK OR SHL(BOOL_TO_LWORD(LONG_ARRAY[IDX]), IDX);
18    mask := SHL(BOOL_TO_LWORD(LONG_ARRAY[IDX]), IDX);
19    LWORD_TMP := mask OR LWORD_TMP;
20  END_FOR;

```

### 17.5.6 Indent/Outdent

Makes indent/outdent at the selected area.

1) Indent

1. Select area to make indent.

```

1
2 CLOCK_SOURCE := _T1S;
3
4 // LEFT rotate, FIND transition
5 IF (*_T1S XOR *) 0 = PREV_STATUS THEN
6 //IF (*_T1S XOR *) 0 = PREV_STATUS AND (PREV_STATUS XOR CLOCK_SOURCE) THEN
7   LINT_VAL := LINT_VAL + 1;
8   %ML0 := %ML0 + 1;
9
10  FOR IDX := 0 TO MAX_VALUE - 1 DO
11    mask := SHL(1, IDX);
12    LONG_ARRAY[IDX] := mask = (LINT_VAL AND mask);
13  END_FOR;
14
15  LWORD_TMP := 0;
16  FOR IDX := 0 TO MAX_VALUE - 1 DO
17    //MASK := MASK OR SHL(BOOL_TO_LWORD(LONG_ARRAY[IDX]), IDX);
18    mask := SHL(BOOL_TO_LWORD(LONG_ARRAY[IDX]), IDX);
19    LWORD_TMP := mask OR LWORD_TMP;
20  END_FOR;

```

2. Press TAB.

```

1
2 CLOCK_SOURCE := _T1S;
3
4 // LEFT rotate, FIND transition
5 IF (*_T1S XOR *) 0 = PREV_STATUS THEN
6 //IF (*_T1S XOR *) 0 = PREV_STATUS AND (PREV_STATUS XOR CLOCK_SOURCE) THEN
7     LINT_VAL := LINT_VAL + 1;
8     %ML0 := %ML0 + 1;
9
10    FOR IDX := 0 TO MAX_VALUE - 1 DO
11        mask := SHL(1, IDX);
12        LONG_ARRAY[IDX] := mask = (LINT_VAL AND mask);
13    END_FOR;
14
15    LWORD_TMP := 0;
16    FOR IDX := 0 TO MAX_VALUE - 1 DO
17        //MASK := MASK OR SHL(BOOL_TO_LWORD(LONG_ARRAY[IDX]), IDX);
18        mask := SHL(BOOL_TO_LWORD(LONG_ARRAY[IDX]), IDX);
19        LWORD_TMP := mask OR LWORD_TMP;
20    END_FOR;

```

2) Outdent

1. Select area to make outdent.

```

1
2 CLOCK_SOURCE := _T1S;
3
4 // LEFT rotate, FIND transition
5 IF (*_T1S XOR *) 0 = PREV_STATUS THEN
6 //IF (*_T1S XOR *) 0 = PREV_STATUS AND (PREV_STATUS XOR CLOCK_SOURCE) THEN
7     LINT_VAL := LINT_VAL + 1;
8     %ML0 := %ML0 + 1;
9
10    FOR IDX := 0 TO MAX_VALUE - 1 DO
11        mask := SHL(1, IDX);
12        LONG_ARRAY[IDX] := mask = (LINT_VAL AND mask);
13    END_FOR;
14
15    LWORD_TMP := 0;
16    FOR IDX := 0 TO MAX_VALUE - 1 DO
17        //MASK := MASK OR SHL(BOOL_TO_LWORD(LONG_ARRAY[IDX]), IDX);
18        mask := SHL(BOOL_TO_LWORD(LONG_ARRAY[IDX]), IDX);
19        LWORD_TMP := mask OR LWORD_TMP;
20    END_FOR;

```

2. Press Shift + TAB.

```

1  CLOCK_SOURCE := _T1S;
2
3
4 // LEFT rotate, FIND transition
5 IF (*_T1S XOR *) 0 = PREV_STATUS THEN
6 //IF (*_T1S XOR *) 0 = PREV_STATUS AND (PREV_STATUS XOR CLOCK_SOURCE) THEN
7   LINT_VAL := LINT_VAL + 1;
8   %ML0 := %ML0 + 1;
9
10  FOR IDX := 0 TO MAX_VALUE - 1 DO
11     mask := SHL(1, IDX);
12     LONG_ARRAY[IDX] := mask = (LINT_VAL AND mask);
13     END_FOR;
14
15  LWORD_TMP := 0;
16  FOR IDX := 0 TO MAX_VALUE - 1 DO
17     //MASK := MASK OR SHL(BOOL_TO_LWORD(LONG_ARRAY[IDX]), IDX);
18     mask := SHL(BOOL_TO_LWORD(LONG_ARRAY[IDX]), IDX);
19     LWORD_TMP := mask OR LWORD_TMP;
20  END_FOR;

```

## Chapter 18 Dedicated XGR Function

This function is for XGR series.

### 18.1 Redundancy Parameter

Double-click [Redundancy Parameter] on Project Window to set redundancy parameter.

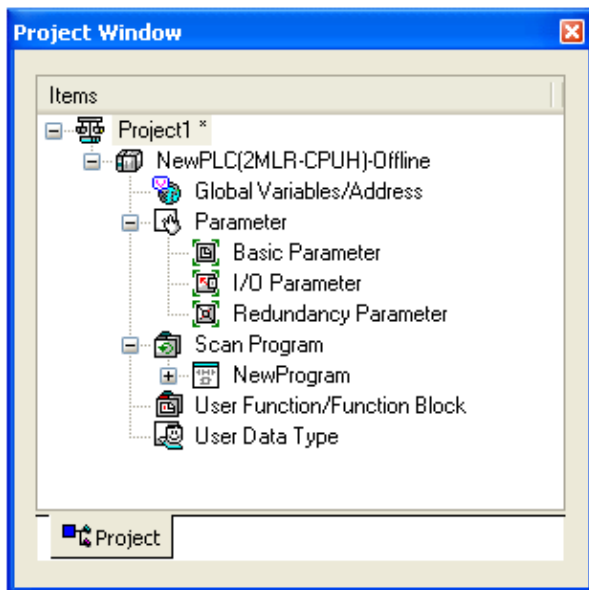

Redundancy parameter is consisting of 'Run Mode' and 'Redundancy synchronization area'.

## Chapter 18 Dedicated XGR Function

[Dialog box]

**Redundancy Parameter**

**Run Mode**

Disable the warning message about Single CPU Mode

Extended Base Detach Error

**Redundancy synchronization area**

	Used	Start	End
I/Q Base	<input checked="" type="checkbox"/>	0	31
M Area	<input checked="" type="checkbox"/>	%MW0	%MW2000
R Area	<input checked="" type="checkbox"/>	%RW0	%RW2000
W Area	<input checked="" type="checkbox"/>	%WW0/%WW32768	%WW2000/%WW34768
PID Block	<input checked="" type="checkbox"/>	0	0

Buttons: OK, Cancel, Default

[Description of dialog box]

- a. Disable the warning message about Single CPU Mode: If Master CPU is operated without standby CPU, the warning message of redundancy system will be appeared. If it is checked, the warning message will not be appeared. The default value is appearing warning message.
- b. Extended Base Detach Error: When extended base is detached, it decides whether that is considered as error or entire system goes to initial status and restarts the operation when extended base is attached again. The default value is that entire system goes to initial status and restarts the operation when extended base is attached again.
- c. I/Q Base: It synchronizes a data of I/Q Base data. It can set from the first base to the final base. By checking the box, it determines whether synchronizing I/Q area or not. If it is checked, it synchronizes from first base to final base. The default value is 0~31 base.
- d. M Area: It synchronizes data of M area. It can set from the position of first word to the position of final word. By checking the box, it determines whether synchronizing M area or not. If it is checked, it synchronizes from first area to final area. The default value is %MW0~%MW2000.
- e. R Area: It synchronizes data of R area. It can set from the position of first word to the position of final word. By checking the box, it determines whether synchronizing R area or not. If it is checked, it synchronizes from first area to final area. The default value is %RW0~%RW2000.
- f. W Area: If R area is set, synchronization area of W area will be define automatically. Initial value is.
- g. PID Block: It synchronizes data of PID block. It can set from the first block to final block. By checking the box, it determines whether synchronizing PID block area or not. If it is checked, it synchronizes from block area to final block area. The default value is 0 block.
- h. Default: Initialized to Default setting.
- i. OK: Saved the setting value of Run mode and Redundancy synchronization area.
- j. Cancel: Cancel the setting value of Run mode and Redundancy synchronization area.

## 18.2 Redundancy PLC State Window

Redundancy PLC state window appear automatically when XG5000 connects with XGR PLC.

[Description of dialog box]

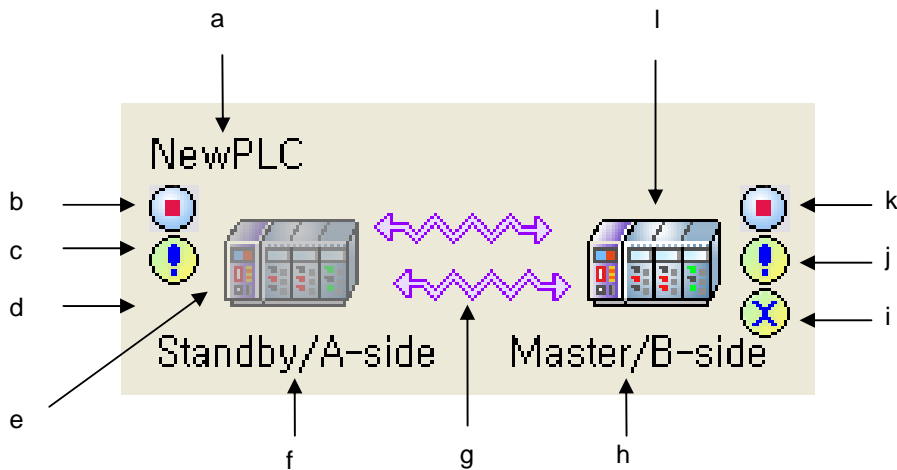

- a. Project name or program name: Project name of XG5000 or Program name of XG-PD/System Monitor
- b. A-side PLC Run mode
- c. A-side PLC Warning: No-display if warning is not existed.
- d. A-side PLC error: No-display if error is not existed.
- e. Standby CPU image: Shaded PLC
- f. CPU status display: Standby, A-side
- g. Signal line: 1 line – Bus topology, 2 lines – Ring topology
- h. CPU status display: Master, B-side
- i. B-side PLC error: No-display if warning is not existed.
- j. B-side PLC warning: No-display if error is not existed.
- k. B-side PLC Run mode
- l. Master CPU image: Colored PLC

### 18.3 Control Redundancy

Selects [Online] – [Control Redundancy].

#### 18.3.1 Change of master CPU

[Description of dialog box]

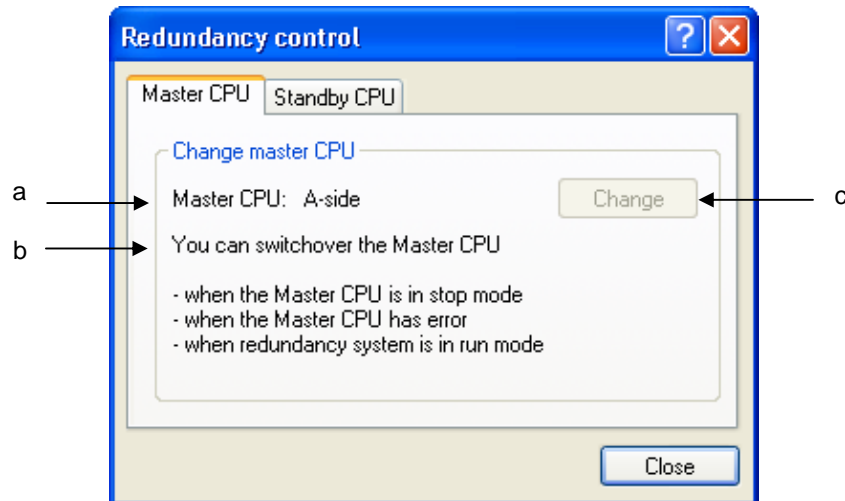

- a. Master CPU: Display of Master CPU, A-side or B-side
- b. You can switchover the Master CPU: It displays state of redundancy changeable state. If it is disable, it displays the possible case to make redundancy change.
- c. Change: Redundancy change command. If redundancy change is not disabling, it displays by inactive mode.

#### Notes

In case Redundancy state is changeable,

1. When the Master CPU is in stop mode
2. When the Master CPU has error
3. When the redundancy system is in run mode

### 18.3.2 Standby CPU control

[Description of dialog box]

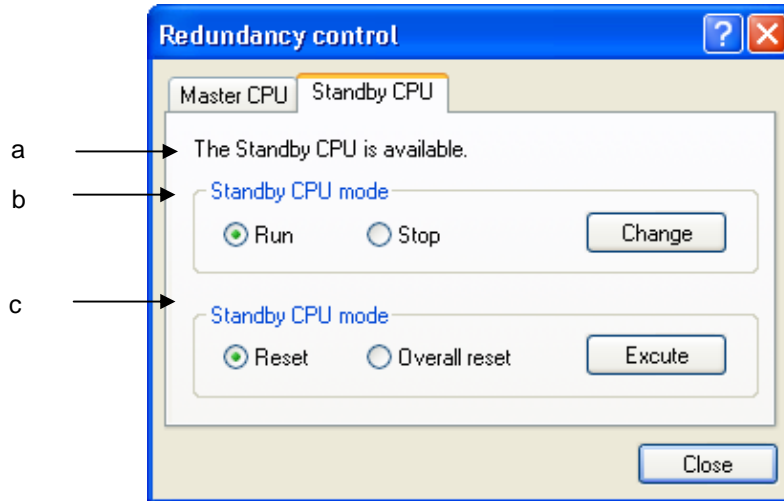

- a. Standby CPU: Available Standby CPU state
- b. Standby CPU mode: Standby CPU Run/Stop mode change
- c. Standby CPU reset: Only Standby CPU Reset or Overall reset



# Chapter 18 Dedicated XGR Function

## 18.4 System Monitoring

System configuration and base information is displayed by System Monitoring.

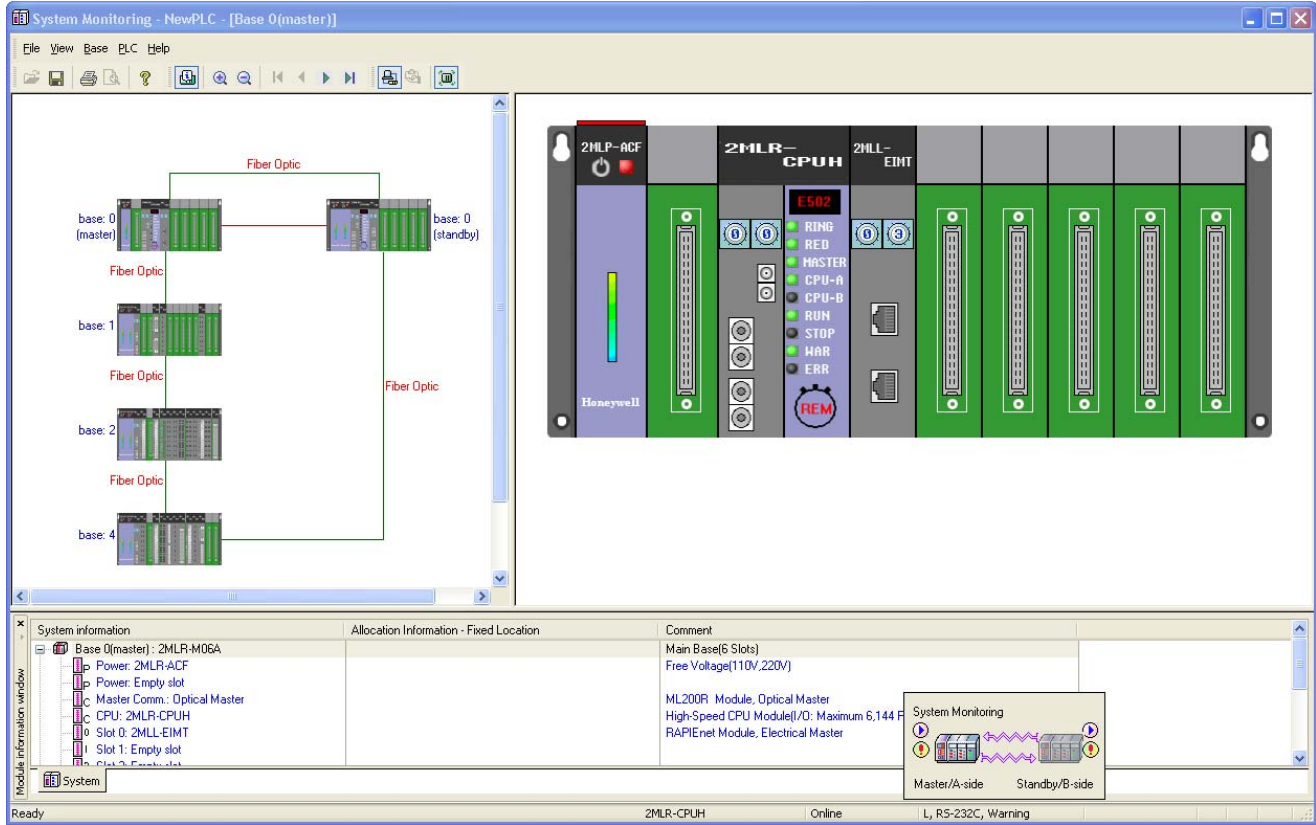

### 18.4.1 System Configuration

Selects [PLC] – [System Configuration].

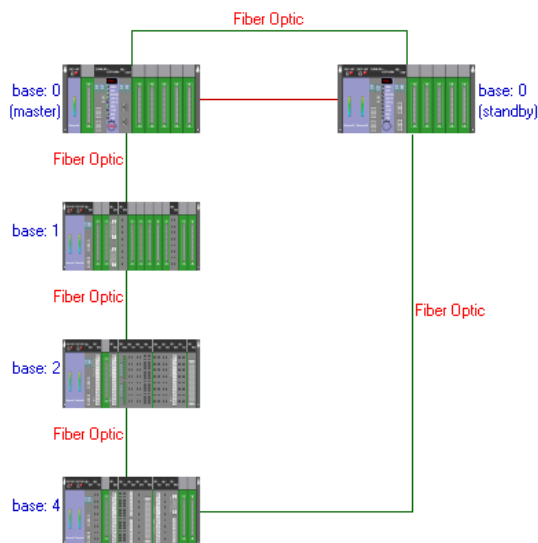

System configuration contains below information.

1. Connection state between base
2. Connection cable type between base
3. In case of electric cable, it displays measured time and distance.
4. It displays data synchronization cable between Master and Standby CPU.
5. It displays base information of selecting base by clicking mouse button (or pressing enter key).

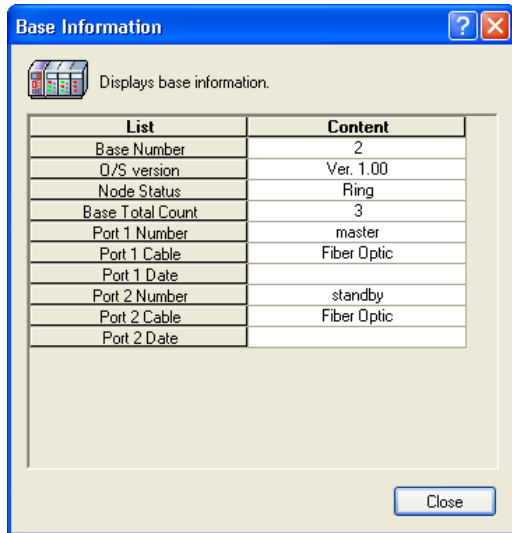

### 18.4.2 Node Count change

Node Count change makes to decide how many node displays in window.

To change Node Count, selects [View] – [Node Count], then selects node among [2], [3], [4], [5], [6]. Default setting value is 2.

1. [View] - [Node Count] - [2]

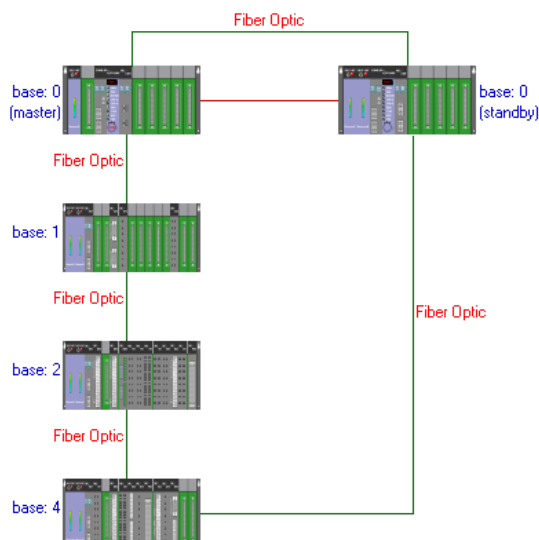

## Chapter 18 Dedicated XGR Function

2. [View] - [Node Count] - [4]

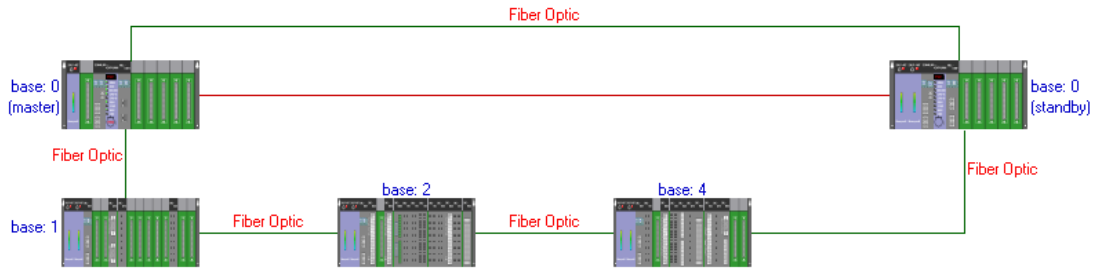

### 18.4.3 Base information

It displays base information installed in base.

1. Master/Standby base

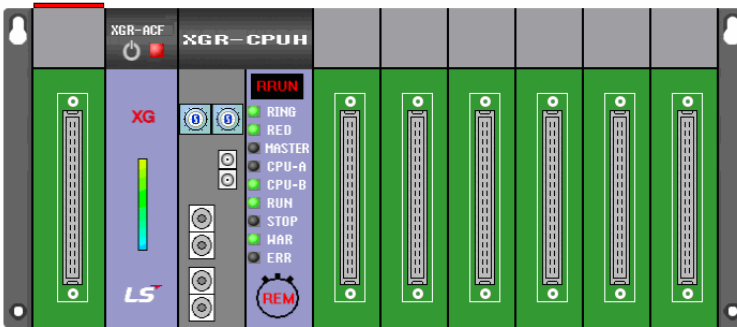
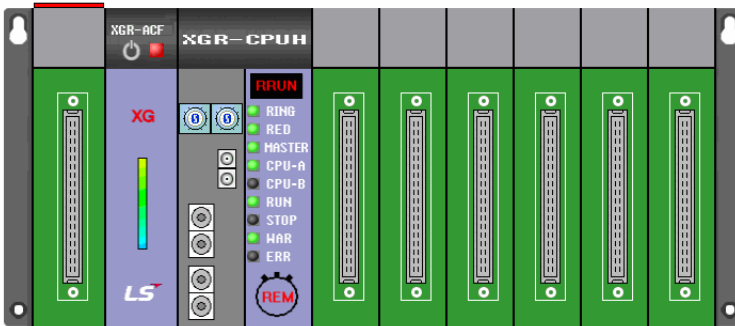

- (1) It displays information and base number of CPU module.
- (2) State indicator: It indicates state of CPU.
- (3) RING: If it is consisted of Ring topology, LED indicates On.
- (4) RED: If it is operated by Redundancy operation, LED indicates On.
- (5) MASTER: If it is master mode, LED is On.
- (6) CPU-A: If CPU-A is On, LED indicates On.
- (7) CPU-B: If CPU-B is On, LED indicates On.
- (8) RUN: If operation mode is Run mode, LED indicates On.
- (9) STOP: If operation mode is Stop mode, LED indicates On.
- (10) WAR: Warning is occurred in CPU, LED indicates On.
- (11) ERR: Error is occurred in CPU, LED indicates On.
- (12) Key state: Key state information of CPU

### 2. Expansion base

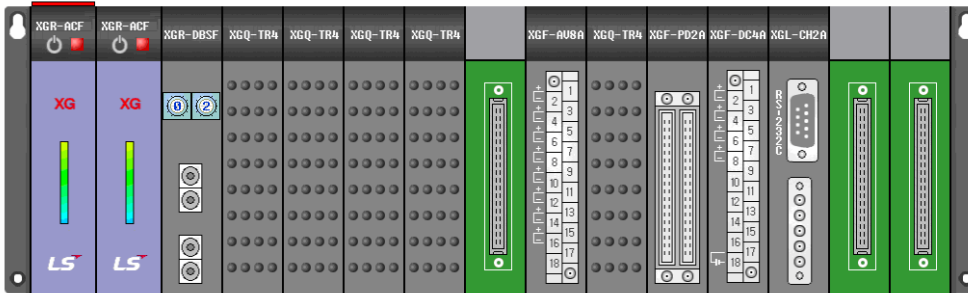

(1) It displays base number of expansion module.

### 3. Base information

- (1) Base information contains the information of base connection and cable.
- (2) By selecting expansion drive module/expansion manager and [PLC] – [Module Information], Base information will be appeared.
- (3) By Double-clicking expansion drive module/expansion manager, Base information will be appeared.

[Dialog box]

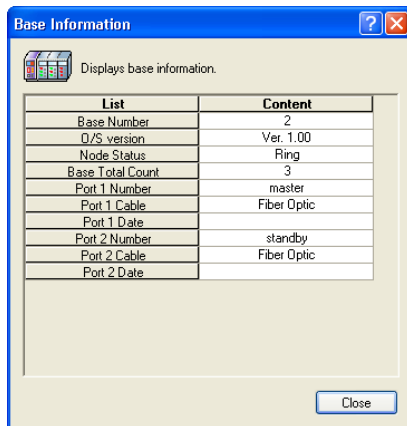

[Description of dialog box]

- a. Base Number: Base number which is set in the switch of base setting for expansion drive module
- b. O/S version: OS version of expansion drive module
- c. Node Status: It displays connection status between bases whether it is Ring or Bus operation.
- d. Base Total Count: Total number of nodes
- e. Port 1 Number: Base number connected with port 1
- f. Port 1 Cable: Cable type (Optic/Electric) connected with port 1
  - In case of Electric cable, it displays the measured length of cable for port 1.
- g. Port 1 Date: In case of Electric cable, it displays the measured date for port 1.
- h. Port 2 Number: Base number connected with port 2.
- i. Port 2 Cable: Cable type (Optic/Electric) connected with port 2
  - In case of Electric cable, it displays the measured length of cable for port 1.
- j. Port 2 Date: In case of Electric cable, it displays the measured date for port 1.

## Chapter 18 Dedicated XGR Function

### j. Base Changing Wizard

Base can be changed easily by Base Changing Wizard while PLC is operating. Base Changing Wizard has 4 steps Selecting Base, Removing Base, Installing New Base, and Changing Base Finished.

#### Notes

In XGR system, a part of expansion base can be exchanged according to configuration of expansion base.

1. Ring topology: All expansion bases can be exchanged.
2. Bus topology: In Bus topology, final expansion base is only changed.

#### [Steps]

1. Selects [Online] – [Base Changing Wizard].
2. In Selecting Base step, selects base for changing and click Next button.

#### [Dialog box]

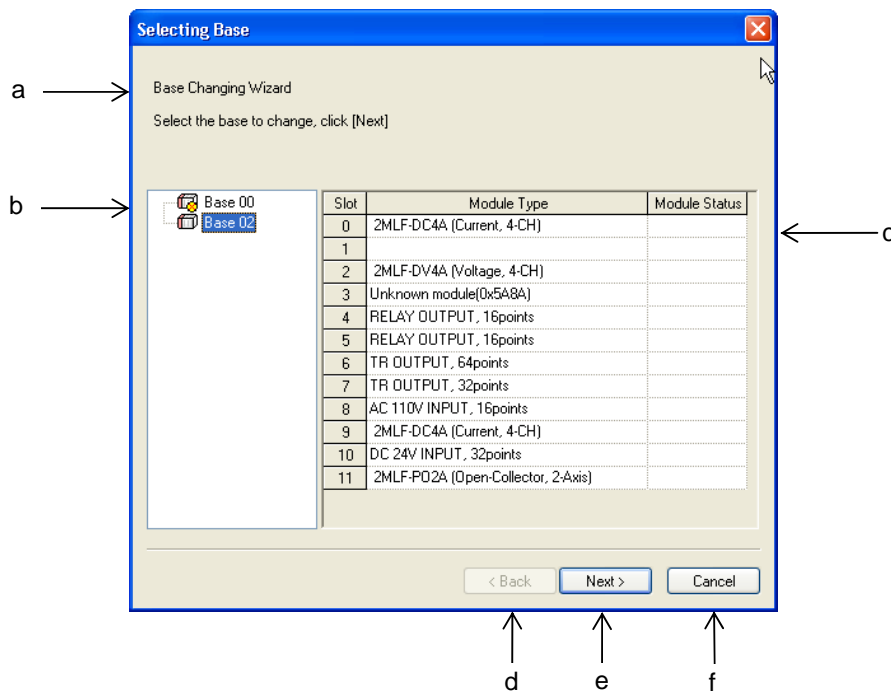

#### [Description of dialog box]

- a. Information: Information of Selecting Base step
- b. Base module tree: It displays base module. Changeable base is displayed according to connection state of expansion base.

(📁): Changeable base, (🔒): Non-changeable base )

- c. List of module on slot: It displays the information of module on selected base.
- d. Back: It is always inactive mode while selecting base step.
- e. Next: Next step to Removing Base step. It is active mode when changeable base is selected.
- f. Cancel: Cancel Base Changing Wizard execution.

#### Notes

If Base Changing Wizard execution is canceled, selected base is excluded from operation. Please check Fault Mask and I/O Skip.

3. Follow the information of Removing Base step, click Next button.

[Dialog box]

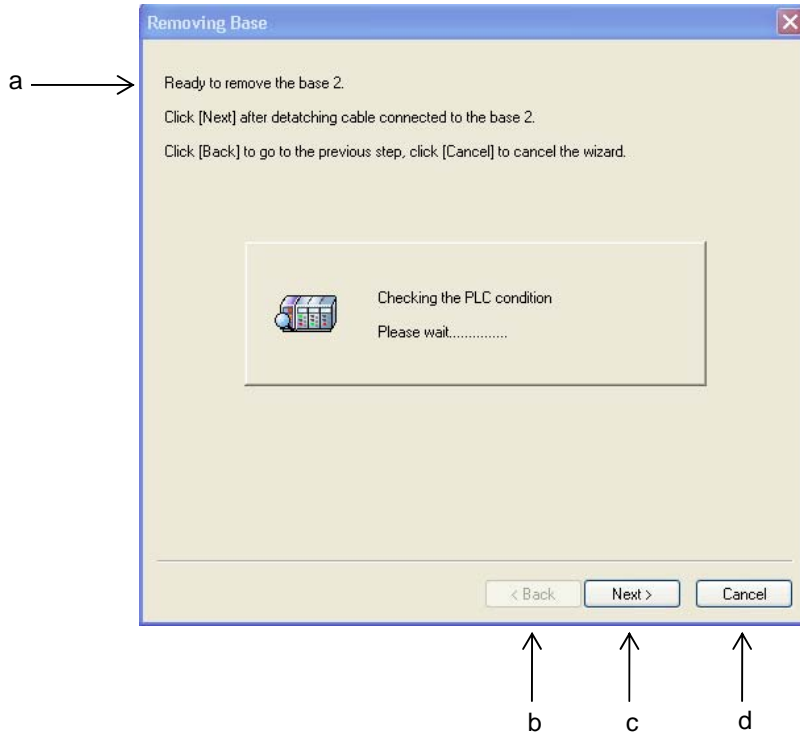

[Description of dialog box]

- a. Information: Information of Removing Base step.
- b. Back: Cancel Removing Base step, go to previous step.
- c. Next: Move to Installing Base step.
- d. Cancel: Cancel Base Changing Wizard.

**Notes**

Error in Removing Base is occurred when base is not removed.

## Chapter 18 Dedicated XGR Function

4. Follow the information of Installing New Base step, click Next button.

[Dialog box]

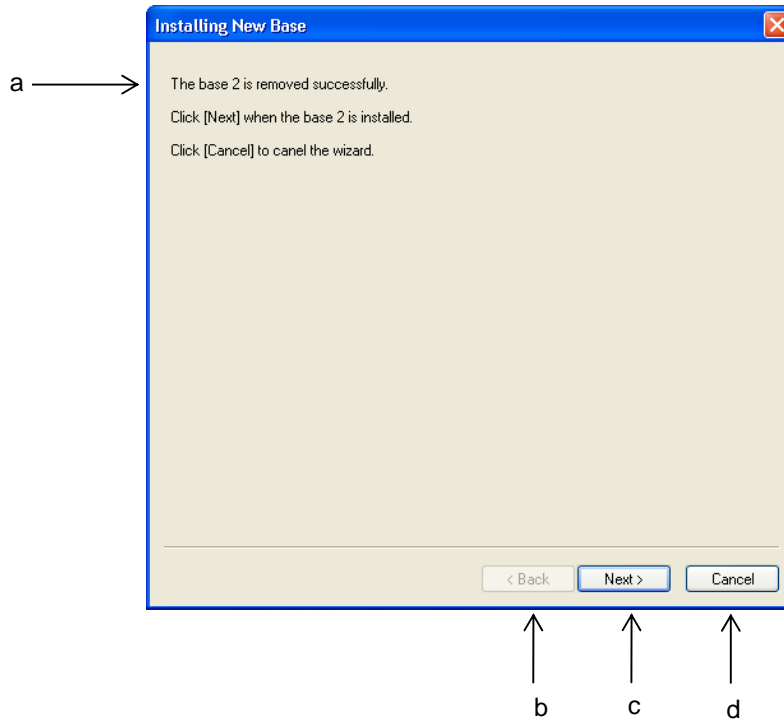

[Description of dialog box]

- a. Information: Information of Installing New Base
- b. Back: It is inactive mode after base is removed.
- c. Next: Move to Changing Base Finished step.
- d. Cancel: Cancel the Base Changing Wizard.

### Notes

Error in Installing New Base is occurred when base is not installed. If base is installed normally, error is occurred when module type is different within setting module in I/O parameter and real installed base.

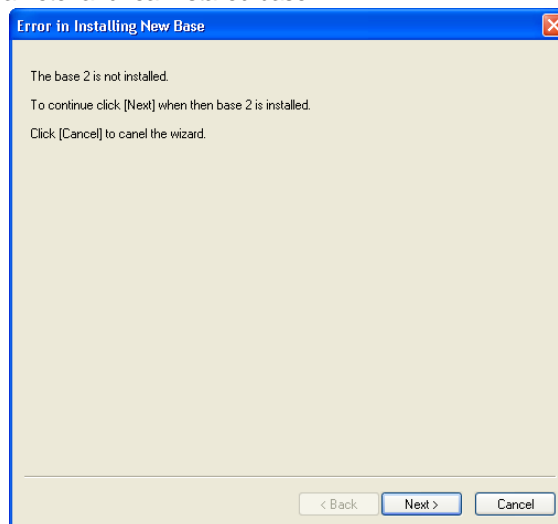

5. Click [Finished], when Changing Base is finished.

[Dialog box]

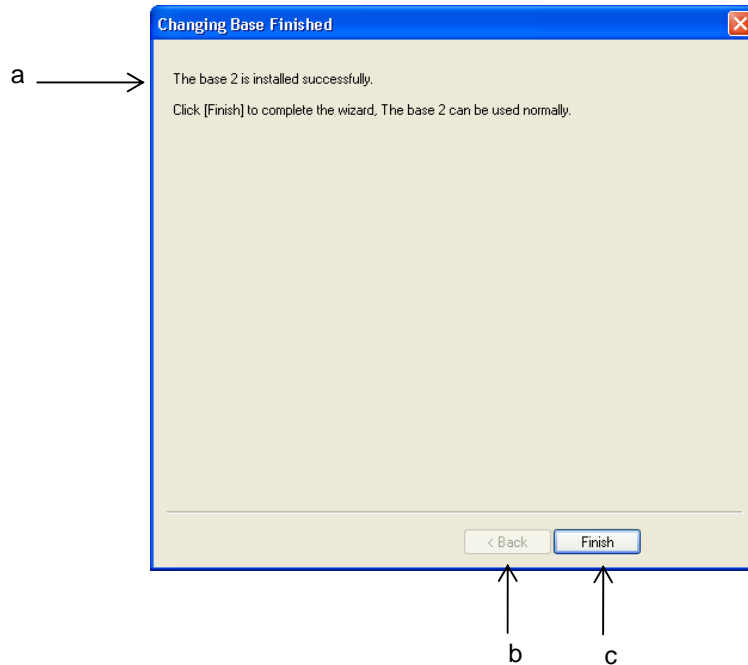

[Description of dialog box]

- a. Information: Information of Changing Base Finished
- b. Back: It is inactive mode after base is removed.
- c. Finish: Finish Base Changing Wizard

### Notes

Please follow below step when base changing without Base Changing Wizard.

[Step]

1. Set [I/O Skip] setting to change on base.
2. Set Fault Mask on base.
3. Remove the base from PLC.
4. Install the base to change.
5. Release [I/O Skip] setting on corresponding base.
6. Selects [Online] – [PLC Errors/Warnings], Check the error in base.
7. Selects [Online] – [I/O Information], Check the module is installed normally.
8. If there is no error, release the Fault Mask on corresponding base.

Please refer to XGR CPU User's Manual for additional explanation.



# Chapter 19 Exclusive Functions for Event Input Module

## 19.1 Overview

The XGF-SOEA Module (hereinafter, the “event input module”) is for the recording of the events entered from outside. The event input module is a data recording device which can record event information (time and state) in 1ms resolution. The event input module has not program device or external device used in the CPU. The event input is available only for monitoring and file saving using the SOE monitor.

1. XGK/I/R CPU: save 3,000 event at maximum  
(Up to 3,000 events can be saved in the order of occurrence.)
2. XGF-SOEA module: save 300 event at maximum

### 19.1.1 Characteristics of SOE Monitor

1. This is a software package for the operation and monitoring of the XGF-SOEA module of XGT series.
2. This package provides a function that enables independent operation of the SOE monitor, regardless of the XG5000.
3. This enables data monitoring and saving.

### 19.1.2 Functions of the SOE Monitor

The SOE monitor is an exclusive software package which runs on a PC platform and communicates with the CPU of XGK, XGI or XGR series for easy and fast operation of XGF-SOEA.

The major functions of the SOE monitor are as follows.

1. Read/save event history
2. Delete event history
3. View module parameter setting
4. Save event history in and Excel file

### 19.1.3 Files Created in the SOE Monitor

When the user creates and edits a project, the files having the extensions below are created.

1. <Name>.set: the logging file for the event the user has created. This file is created at saving the event.
2. <Name>.xls: the module event file created by the user. Event record is saved in an Excel file.

## Chapter 19 Exclusive Functions for Event Input Module

### 19.2 Screen Configuration

This section describes the basic screen elements, windows and pop-up menus when “Monitor,” “SOE Monitor” is selected in the XG5000 monitor state. The figure below is the beginning shot of the SOE monitor.

[Dialog]

- 1) Select [Monitor]-[SOE Monitor] in the menu.

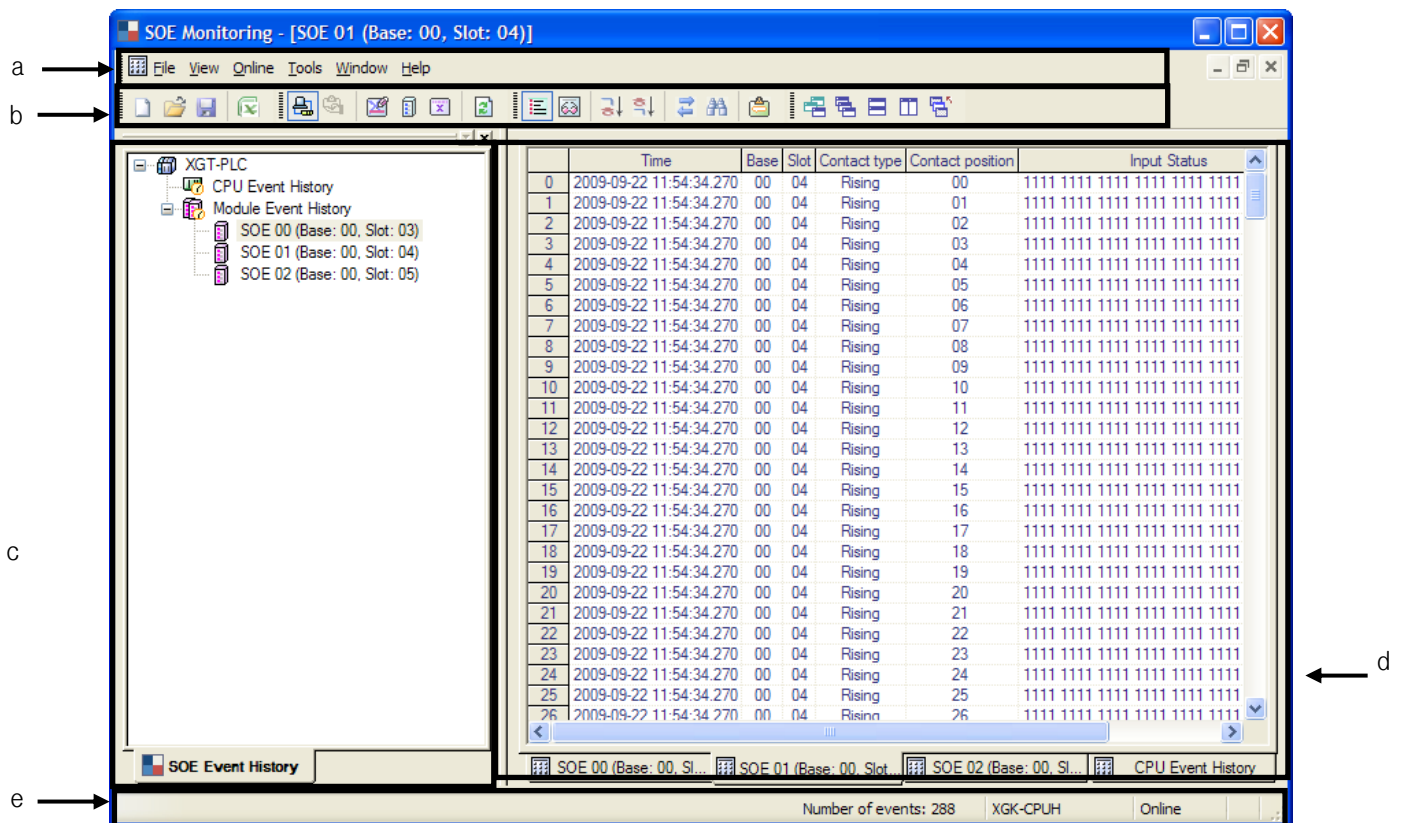

[Dialog] description;

- a. Menu: basic menu is provided for using the software program.
- b. Tools: menu can be easily selected and executed with toolbar.
- c. SOE event history window: shows the elements of the current project.
- d. Event monitor window: shows the event information of the module selected in the project.
- e. Status bar: shows the information of the event and connected PLC.

## 19.2.1 Menu Structure

If you select a menu item, commands appear. The commands can be executed with mouse or keyboard. Some menus provide shortcut keys.

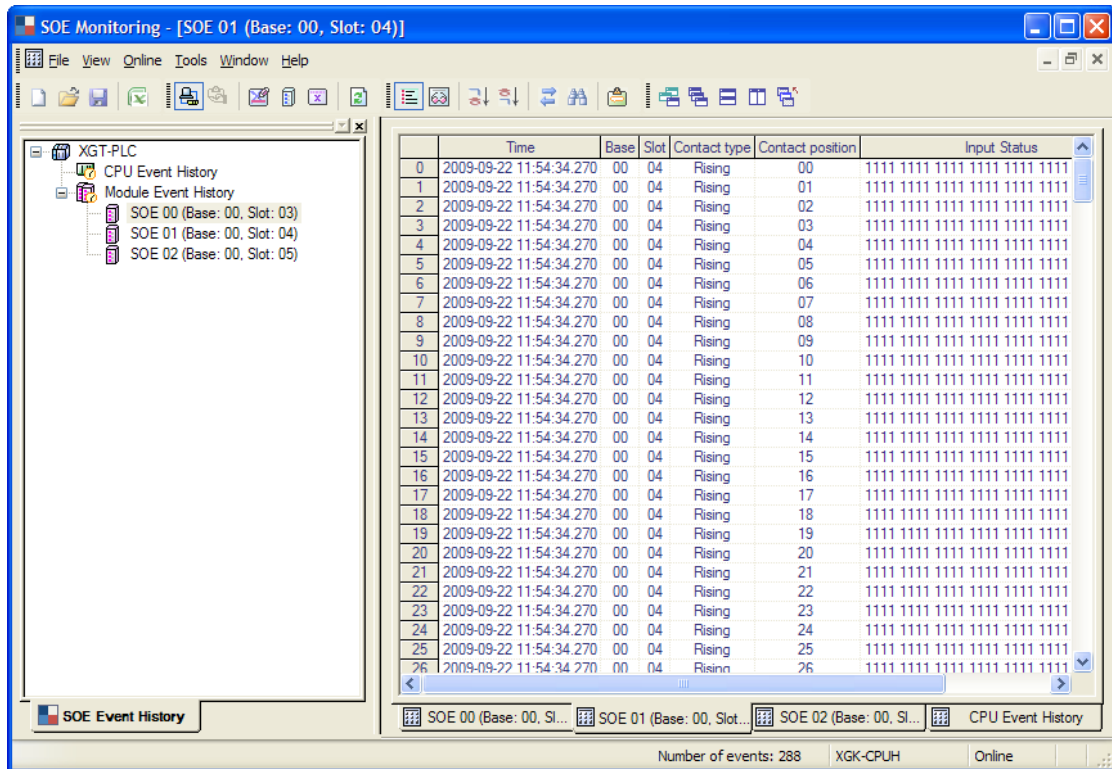

## Chapter 19 Exclusive Functions for Event Input Module

### 1) Project

Command	Description
New logging session	Create the project.
Open logging	Open an existing logging file.
Save logging as	Save the logging file with a different file name.
Export to file	Save the current logging data in an Excel file.
Exit	End the SOE monitor

### 2) View

Command	Description
All events	Show all hidden events in an activated window.
Filtering	Show only the events meeting the filtering criteria.
Newest first	Show the data in the order of recent to old in the monitor window.
Oldest first	Show the data in the order of old to recent in the monitor window.
Find event	Search desired event.
Module Property	Show parameter setting (in online operation)

### 3) Online

Command	Description
Connect/Disconnect	Connect with or disconnect from the PLC.
Connection setting	Set up access method.
Clear PLC event history	Delete the event data saved in the PLC CPU memory.
Clear SOE module event history	Delete the event data saved in the SOE module memory.
Clear all SOE event history	Delete all the event data saved in the memory of the SOE module in the PLC system.
Refresh event	Load the event data of the SOE module.

### 4) Tool

Command	Description
Option	User can configure SOE monitor environment for user convenience.
Customize	User defines tools and commands.

## Chapter 19 Exclusive Functions for Event Input Module

### 5) Window

Command	Description
New window	Open a new window in the activated window.
Cascade	Arrange the windows in the XG5000 in cascade layout.
Tile Horizontally	Arrange the windows in the XG5000 in horizontal layout.
Tile Vertically	Arrange the windows in the XG5000 in vertical layout.
Close all	Close all the windows of the XG5000.

### 6) Help

Command	Description
About SOE monitoring	Provides the information on the SOE monitor.

## 19.2.2 Tools

Frequently used menu items are provided with respective shortcut keys (icons).

You can execute the menu by mouse-clicking on the icon.

[Toolbar]



### 1) Create a new toolbar

You can edit the toolbar with frequently used tools.

[Sequence]

1. Select [Tool]-[Customize] in the menu.
2. Click on the New Tool icon.
3. Enter tool name in the new toolbar dialog.
4. Click on Confirm button. A toolbar without tool will be created.

## Chapter 19 Exclusive Functions for Event Input Module

[Dialog]

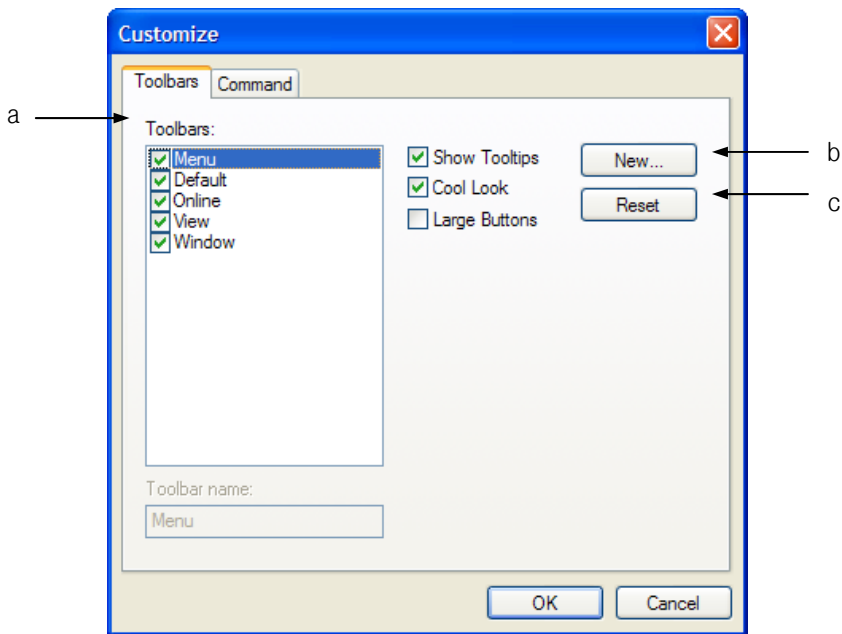

[Dialog] description;

- a. Toolbar: check/remove-check in the check box in front of the items to make the toolbar appear/disappear.
- b. New tool: create a new toolbar.
- c. Reset: initialize the toolbar.

### 2) Add tools to toolbar

Add tools in the toolbar created above.

[Sequence]

1. Select the Command tab in the user definition dialog.
2. Create a toolbar and click on the Confirm button.

[Dialog]

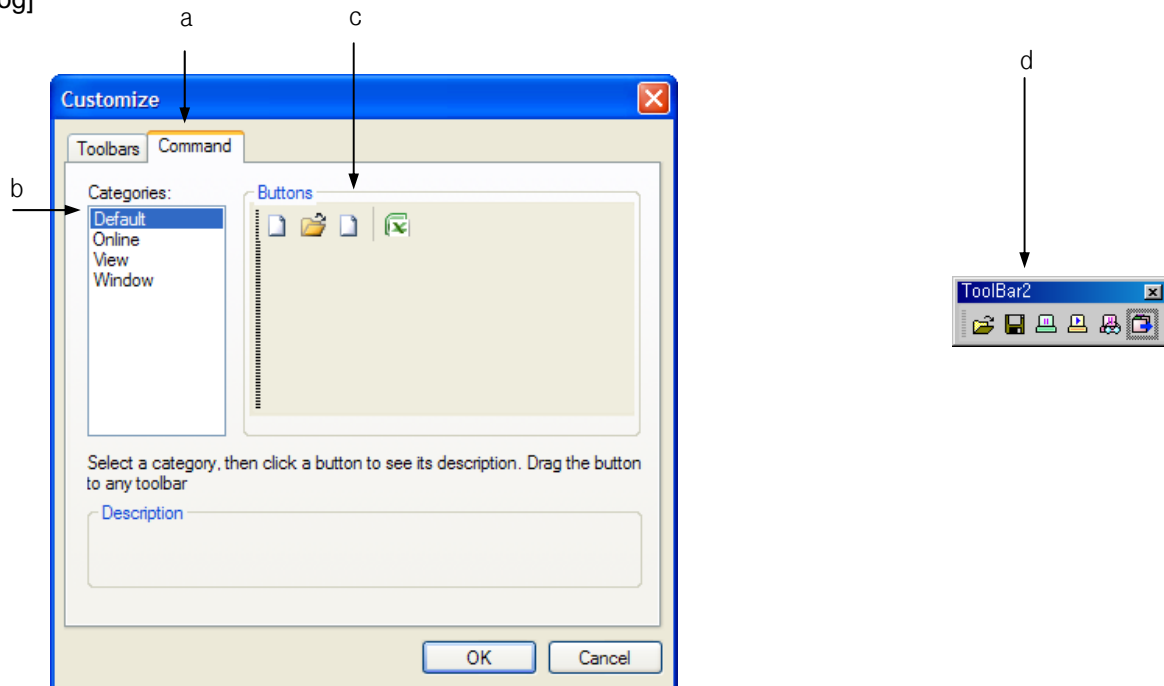

[Dialog] description;

- a. Command: the Command tab in the user definition dialog.
- b. Type: select the existing toolbar.
- c. Button: select the desired tool.

User toolbar: drag-drop the desired tool with the button onto the user toolbar to add it.

## Chapter 19 Exclusive Functions for Event Input Module

### 19.2.3 SOE Event History Window

The SOE monitor displays the XGF-SOEA module SOE event history window automatically when connected with PLC CPU.

Double-click on the desired module to run the event monitor window.

[Dialog]

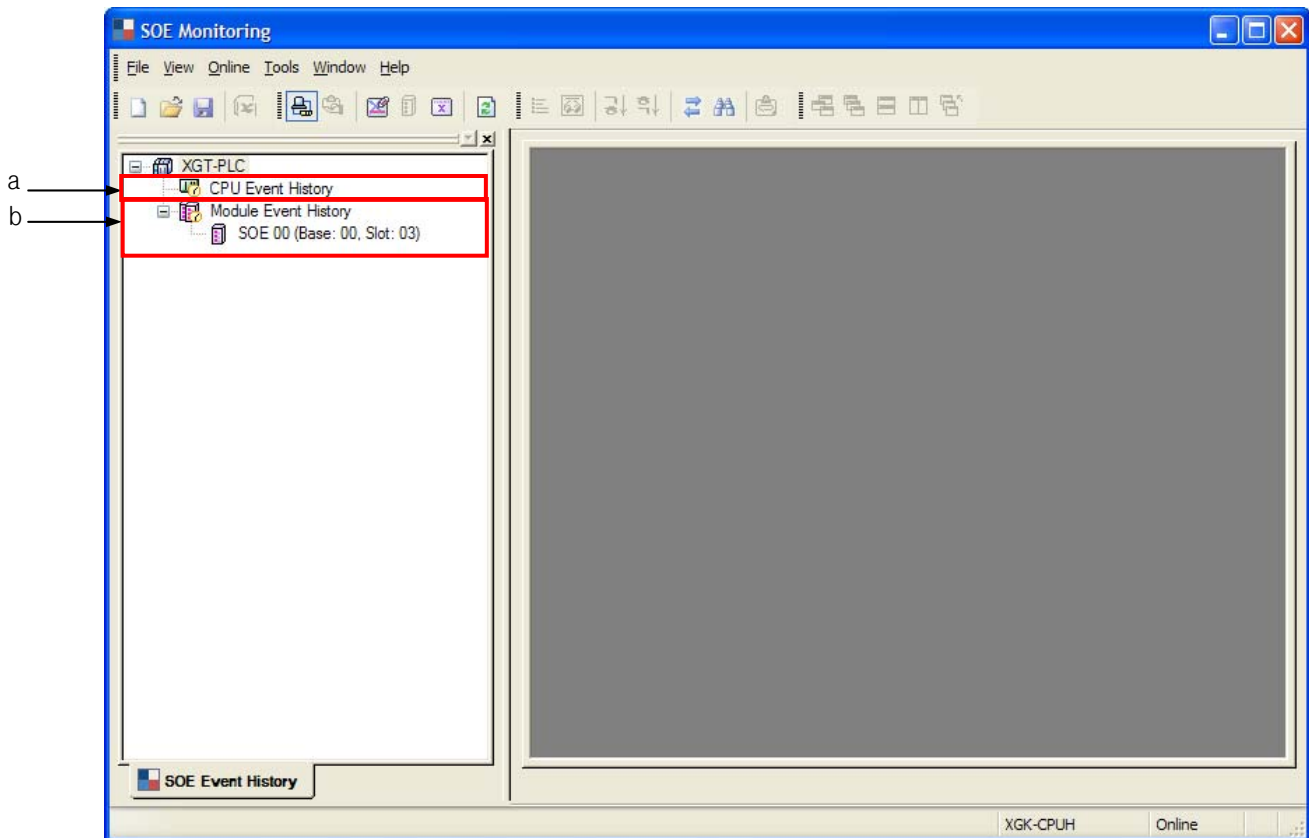

[Dialog] description;

- a. CPU event history: select the event saved in the CPU module.
- b. Module event history: select the event saved in the SOE module.
- c. Double-click on the CPU event history or module event history to activate the event monitor window.



### 19.2.4 Status Bar

[Dialog]

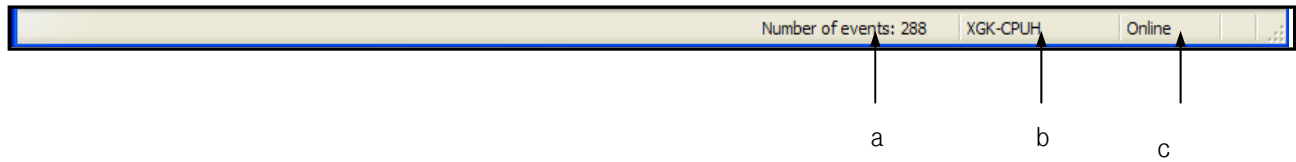

[Dialog] description;

- a. Event No.: show the number of the events in the event monitor window.
- b. PLC name: show the name of the PLC connected with the SOE monitor.
- c. Online: show the PLC connection status of the SOE monitor.

## Chapter 19 Exclusive Functions for Event Input Module

### 19.3 Basic Parameter Setting

Basic parameters of the XGF-SOEA can be set up using the menu or toolbar of the XG5000.

#### 19.3.1 Setting Items

Sets up the method of saving the history occurred in the XGF-SOEA module in the CPU module.

[Sequence]

1) Click on the [Parameter]-[Basic Parameter] in the project tree.

2) Basic operation setting

[Dialog]

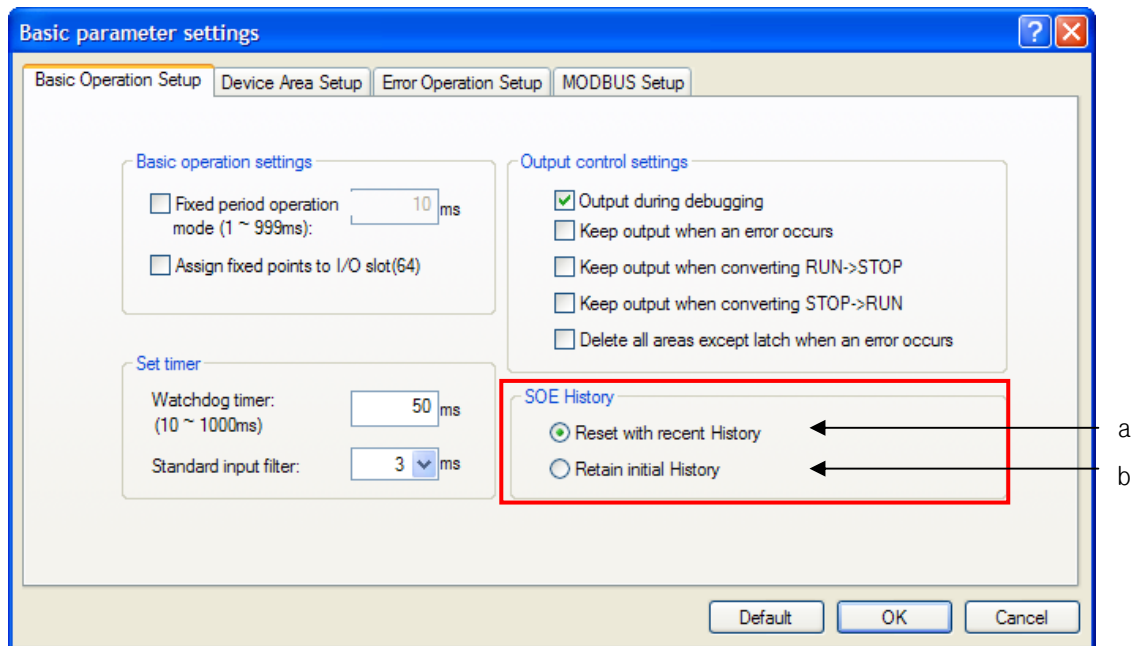

[Dialog] description;

a. Overwrite with recent history: used to save the most recent event. If there are more than 3,000 events, the oldest event is deleted and the new event is saved

b. Maintain the initial history: used to maintain the first event. If there are more than 3,000 events, no new events will be saved.

## 19.4 I/O Parameter Setting

I/O parameters of the XGF-SOEA can be set up using the menu or toolbar of the XG5000.

### 19.4.1 Setting Item

Sets up the method of saving the external event history in the XGF-SOEA module.

[Sequence]

- 1) Click on the [Parameter]-[I/O Parameter] in the project tree.

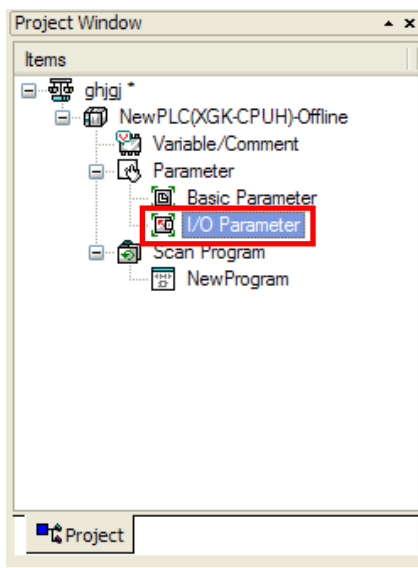

- 2) In the 'I/O Parameter Setting' window, click on the slot of the base where the module is mounted.

In the example below, the XGF-SOEA module is at #4 slot, #0 base.

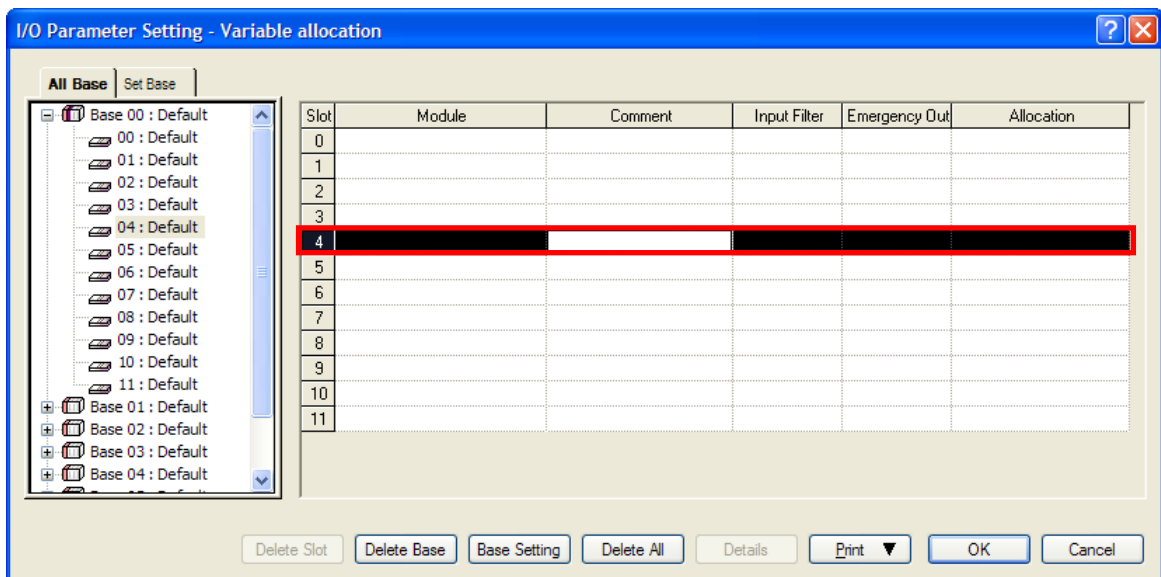

## Chapter 19 Exclusive Functions for Event Input Module

3) In the above window, click on the arrow button. A window where respective module can be selected will appear.

Select the desired module.

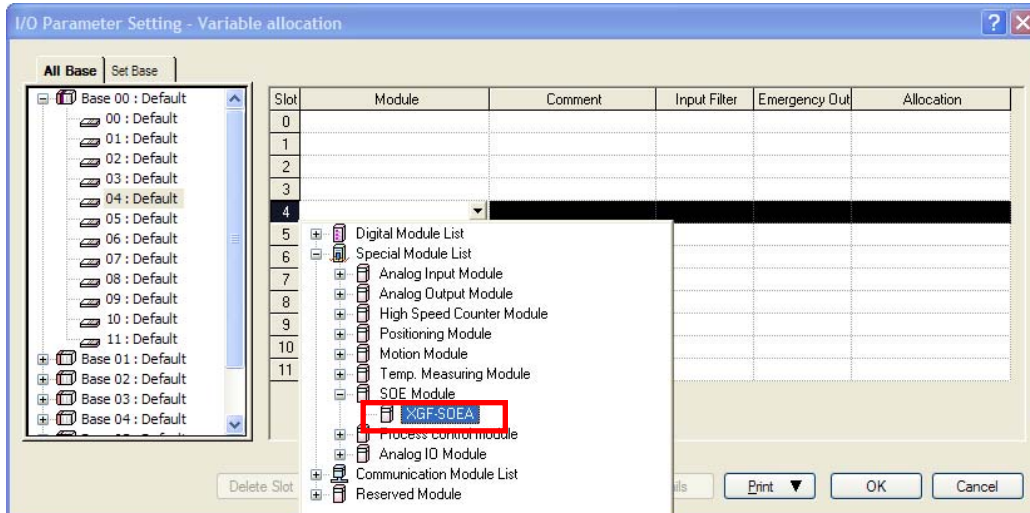

4) After selecting the module, click on the [Detail] button.

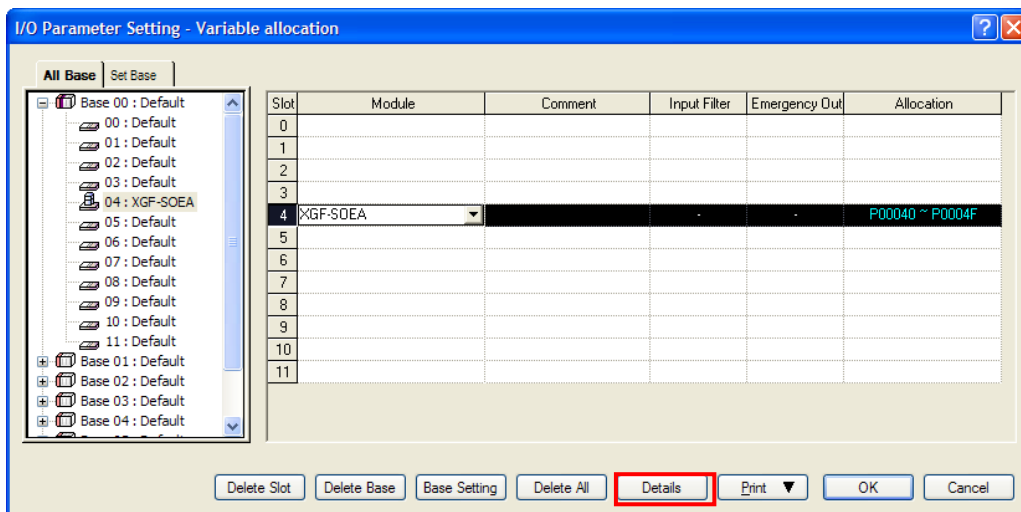

## Chapter 19 Exclusive Functions for Event Input Module

5) With the module selected, click on the [Detail] button.

[Dialog]

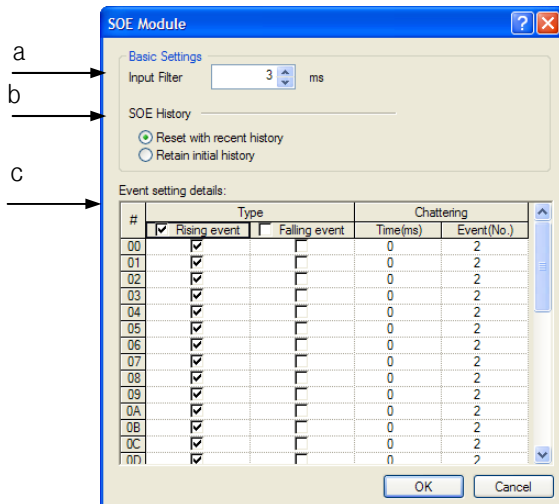

[Dialog] description;

Input filter setting: set up the time which enables an event to be identified as an effective input data.

(Setting range: 1ms ~ 100ms)

a. Event history setting

- Overwrite with recent history: use this to save the most recent event.

If the events exceed 300, the oldest event is deleted and the last one is saved.

- Maintain the initial history: use this to retain the first event.

If the events exceed 300, the last one will not be saved.

b. Detail event setting: set up the input condition of the event.

- Type: 'Rise,' 'Fall' or simultaneously, 'Rise/Fall' of event can be set up.

Event conditions can be set up for each input contact point.

- Chatter: abnormal signals not related with event can be processed as chattering.

(Setting range: 2~127)

## Chapter 19 Exclusive Functions for Event Input Module

6) An example of input filter setting

Condition: A) Input filter: 1ms

B) Detail event setting: 'Rise/Fall' events simultaneously

Sequence diagram of event occurrence;

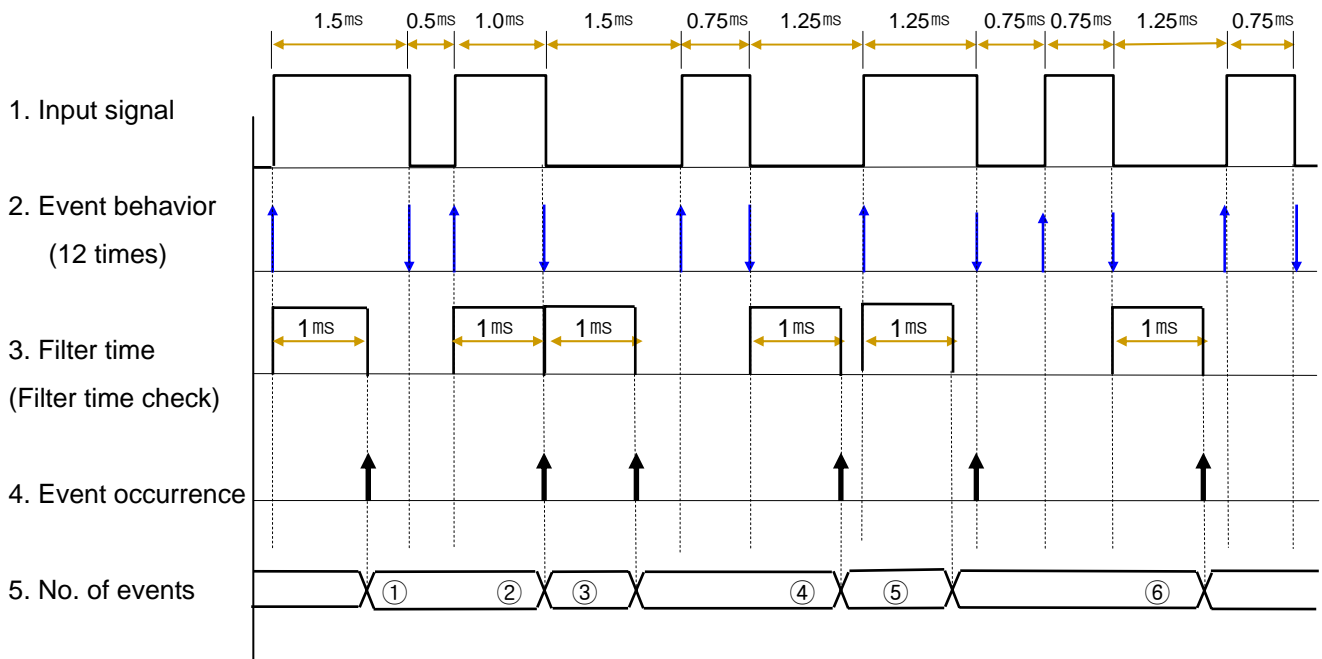

## Chapter 19 Exclusive Functions for Event Input Module

### 7) Chatter Setting

Chatter setting enables the module to identify an event repeated many times during a short period of time as chattering, and not an effective event. Some sensors using mechanical contacts may cause chattering, which can be eliminated with this function.

#### 1. Setting items

- a. Number of events: 2~127 ('0': detection is disabled)
- b. Event number: enter the number of the events including the first effective signal (min. 2)
- c. Chatter detection time (duration): if this chatter detection time has been passed from the time the first effective event was detected, the chatter detection function for the specific event frequency will be terminated, even if the set-up number of chattering has not been completed.
- d. Min. chatter detection time (duration): co-related with the set up chattering event number.

In addition, since an event has passed the input filter, it should satisfy following criteria;

$$\text{(Number of Events} \times \text{Input Filter Value)} < \text{Chatter Detection Time (Duration)}$$

or,

$$\text{Input Filter Value} < \text{(Chatter Detection Time (Duration)} \div \text{Number of Events)}$$

E.g.) If, chatter detection time = 30ms, number of chattering events = 5,

$$30\text{ms} \div 5 = 6\text{ms},$$

therefore, the input filter must be less than 6ms.

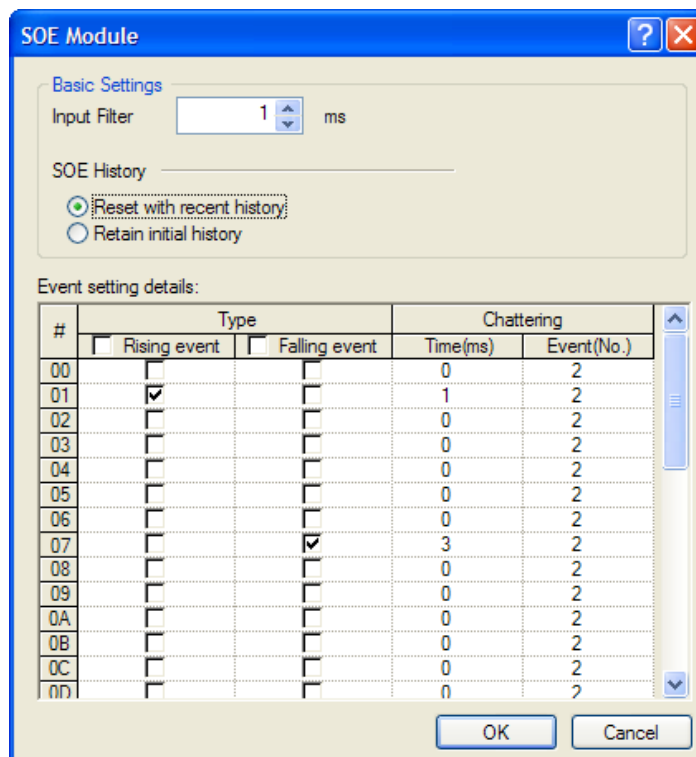

## Chapter 19 Exclusive Functions for Event Input Module

### 2. An example of chatter setting

- Condition:
- A) Input filter: 1ms
  - B) Detail event setting: 'Rise' event
  - C) Chatter event: 4
  - D) Chatter time: 8ms

Sequence diagram of event occurrence;

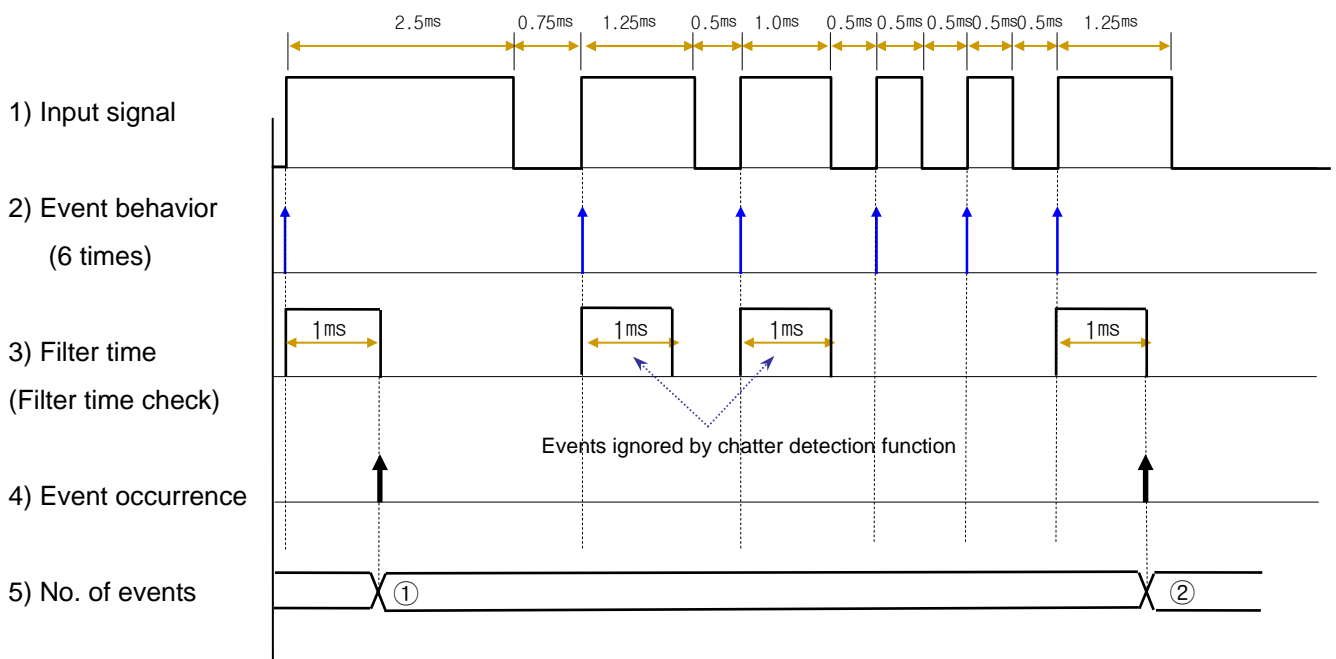

- Chatter time measurement: begins from the recognition of an event
- Two of the four events passing the filter are ignored by chatter detection function.

The last event which enters after expiration of the chatter detection time is recorded normally as the first event of a new period



## 19.5 View Module Information

XG5000 supports viewing event input module information.

[Sequence]

1) [Online] -> [Connect]; select [I/O Information].

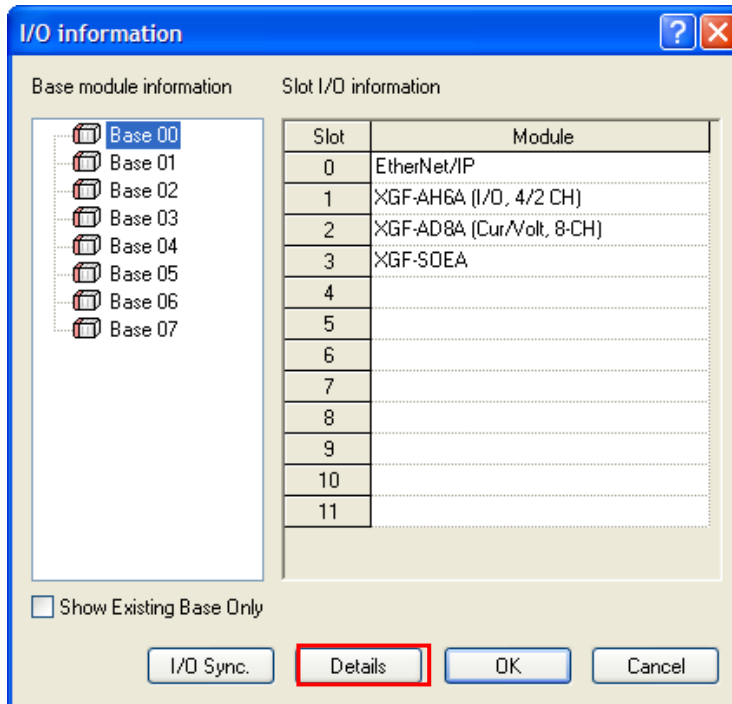

2) Clicking on the [Detail Info] will show XGF-SOEA information as shown below;

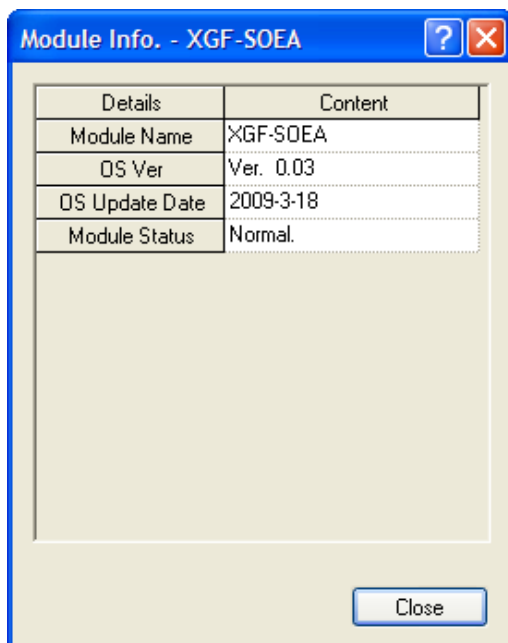

### 19.6 Event History Monitor

The events entered into the CPU and event input modules can be monitored with the SOE monitor.

[Sequence]

1) [Online] -> [Connect]; select [Monitor] -> [SOE Monitoring].

Unless in [Online] state, the [SOE Monitor] menu is not activated.

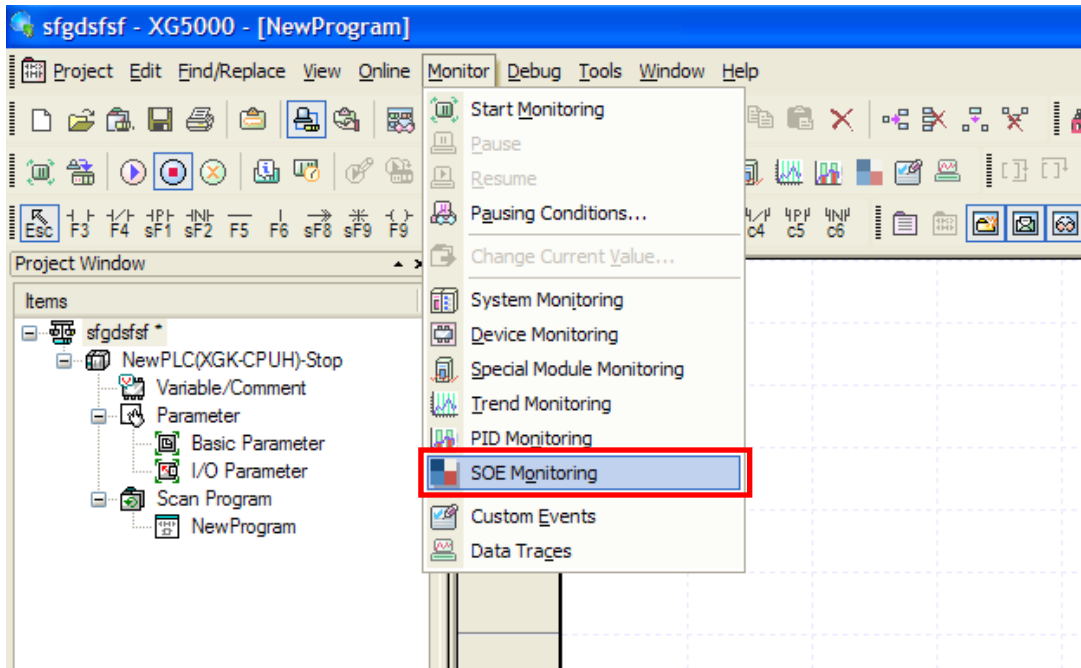

## Chapter 19 Exclusive Functions for Event Input Module

a. [SOE Monitor] will be executed.

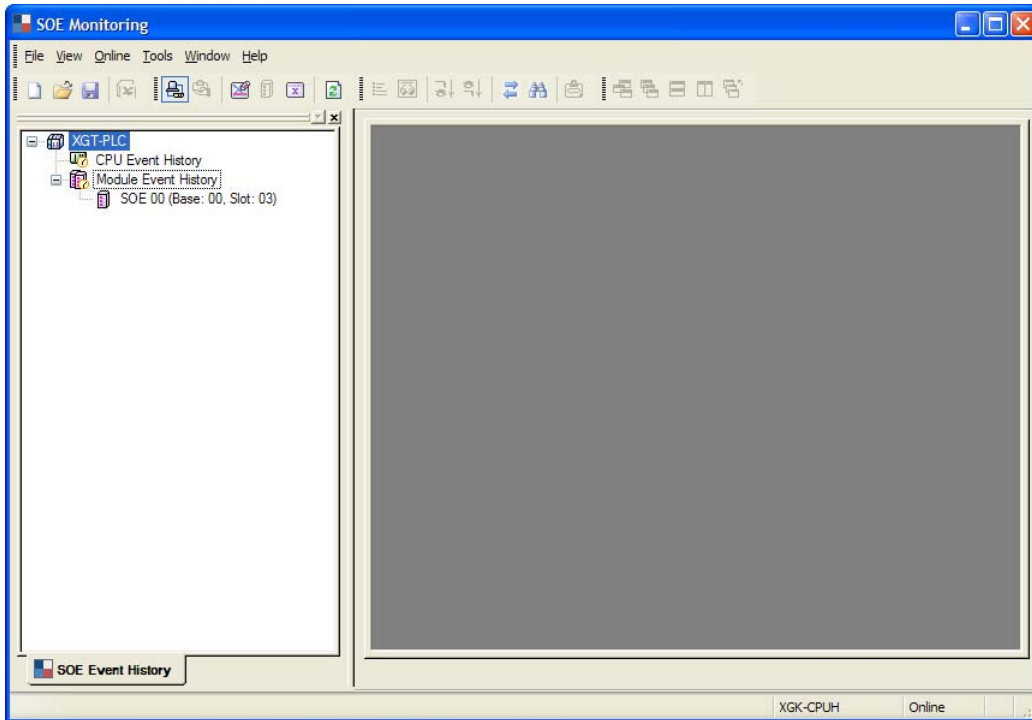

b. Select [Online] -> [Connect].

The information of the event input module in the connected system will appear.

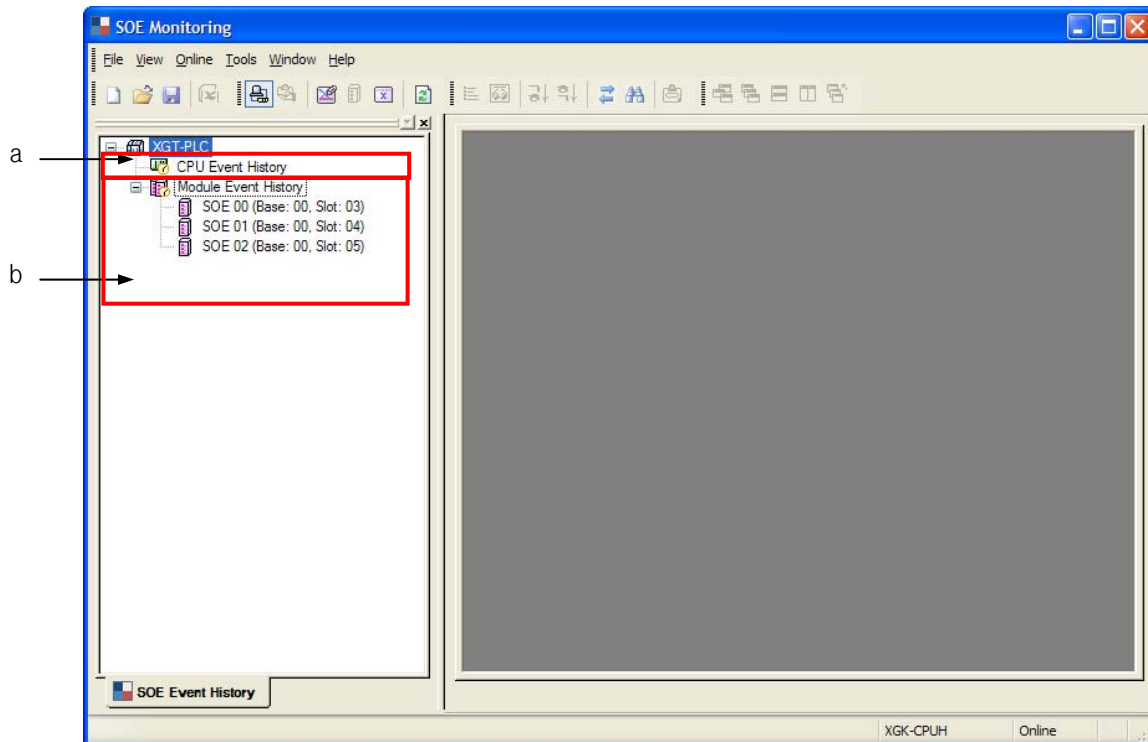

## Chapter 19 Exclusive Functions for Event Input Module

- a. CPU event history: the event history stored in the CPU module.
- b. Module event history: the event history stored in the SOEA module.

Double clicking on the CPU event history or module event history will activate the event monitor window.

- c. Click on the CPU event history.

[CPU Event History] -> double click -> [Online] -> [Refresh Event]

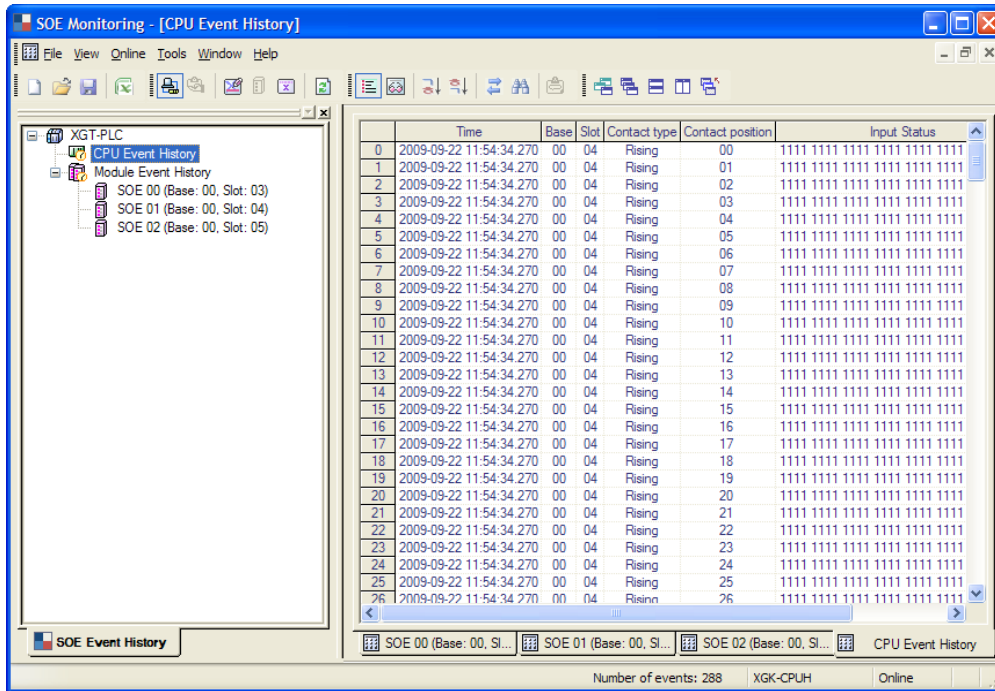

## Chapter 19 Exclusive Functions for Event Input Module

d. Click on the module event history.

[SOE 02 (Base: 00, Slot: 04)] -> double click -> [Online] -> [Refresh Event]

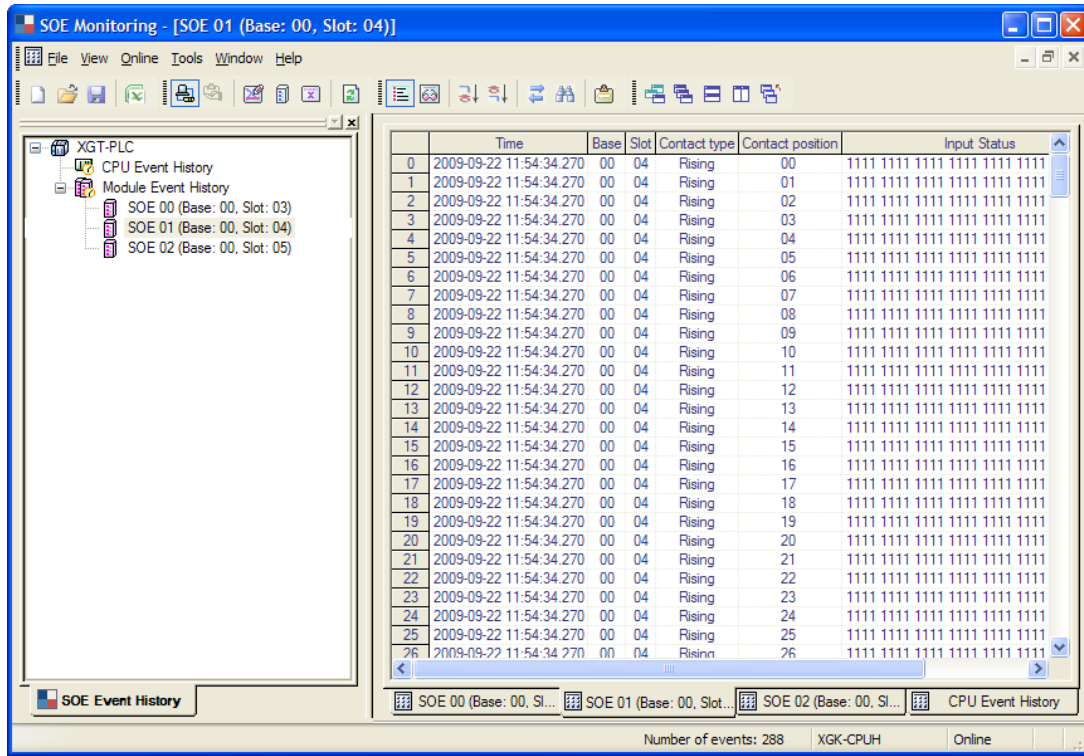

### 2. Event history information

SOE 01 (Base: 00, Slot: 04)						
	Time	Base	Slot	Contact type	Contact position	Input Status
0	2009-09-22 11:54:34.270	00	04	Rising	00	1111 1111 1111 1111 1111 1111
1	2009-09-22 11:54:34.270	00	04	Rising	01	1111 1111 1111 1111 1111 1111
2	2009-09-22 11:54:34.270	00	04	Rising	02	1111 1111 1111 1111 1111 1111
3	2009-09-22 11:54:34.270	00	04	Rising	03	1111 1111 1111 1111 1111 1111
4	2009-09-22 11:54:34.270	00	04	Rising	04	1111 1111 1111 1111 1111 1111
5	2009-09-22 11:54:34.270	00	04	Rising	05	1111 1111 1111 1111 1111 1111

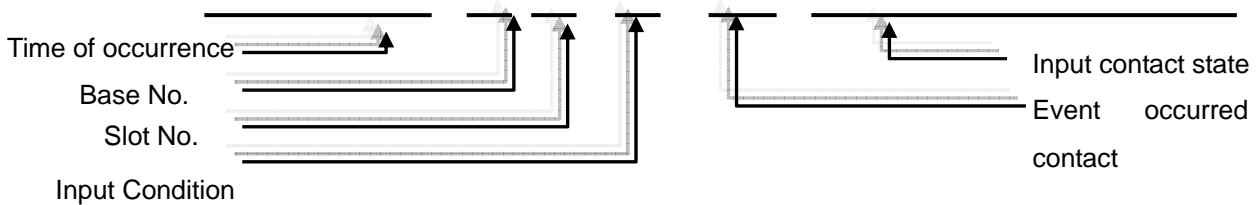

## Chapter 19 Exclusive Functions for Event Input Module

### 2) View

This function provides user convenience including searching and comparing of events.

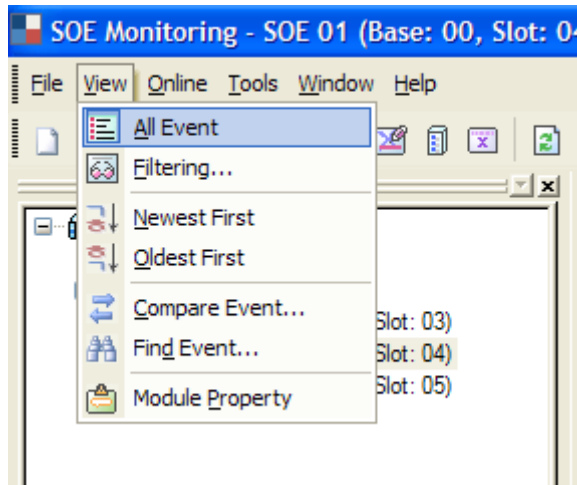

1. Module event display: select [View] -> [Filtering] to look up all the events regardless of the filter setting.

[Sequence]

a. Select [View] -> [All Event].

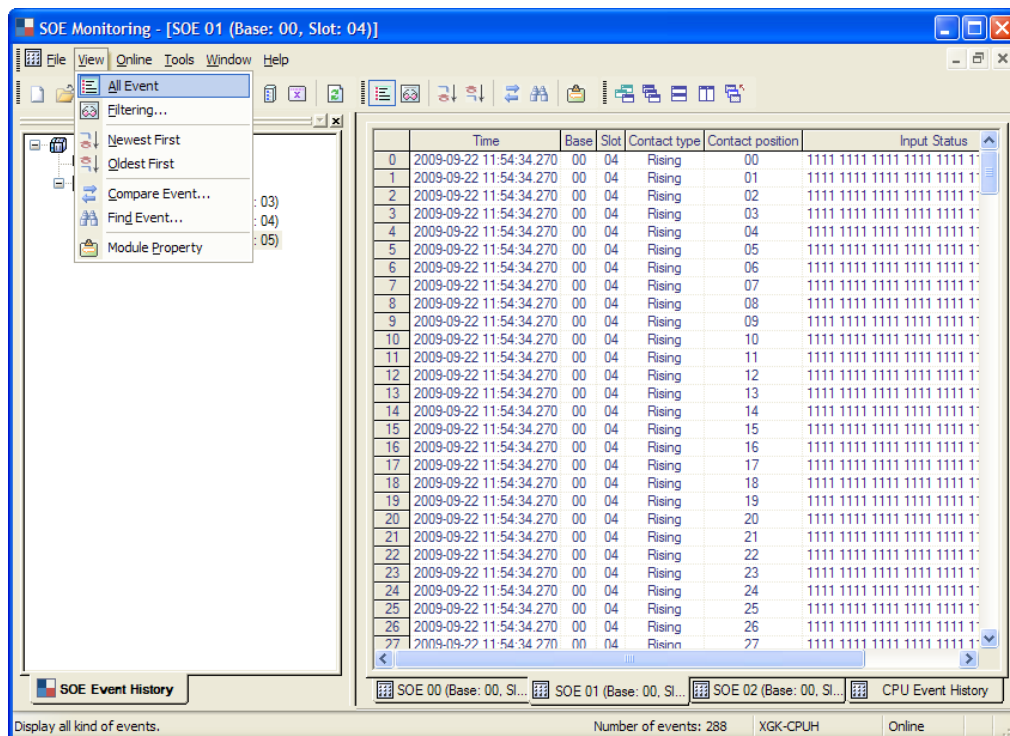

## Chapter 19 Exclusive Functions for Event Input Module

2. Event filter: use this function to search the behavior of a specific event.

[Sequence]

a. Select [View] -> [Filtering].

[Dialog]

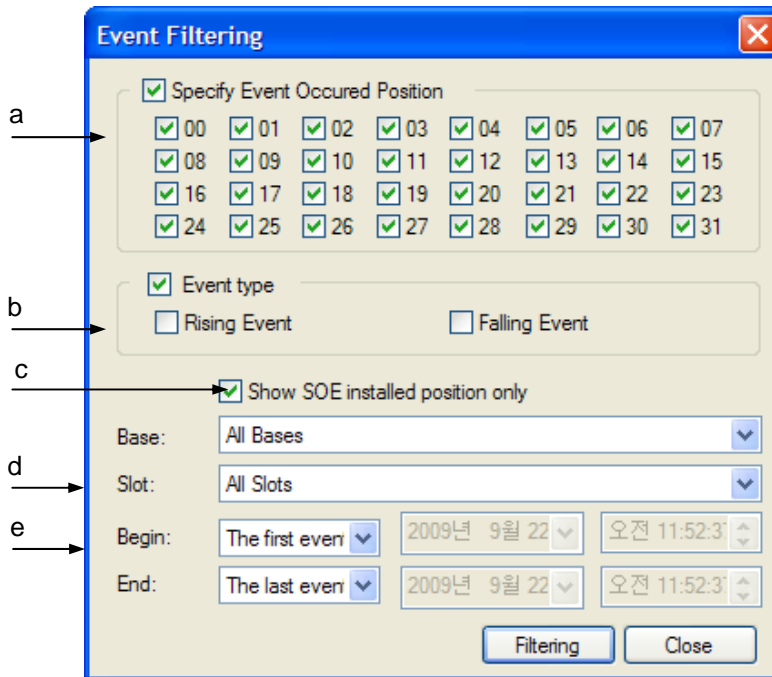

[Dialog] description;

- a. Designate event occurrence point: designate the bit at which the event has occurred.
- b. Designate event type: designate the input condition at which the event has occurred.
- c. Show SOE installed position only: used only for CPU event history filtering.

Only the base and slot of event input module will appear.

- d. Base/Slot: used only for CPU event history filtering. Designates base and slot.
- e. Begin/End: designate the event filter with the time and the first event, and the last event.

# Chapter 19 Exclusive Functions for Event Input Module

## 3. An example of event filter

Select [View] -> [Filtering].

### - Event occurrence point filter setting

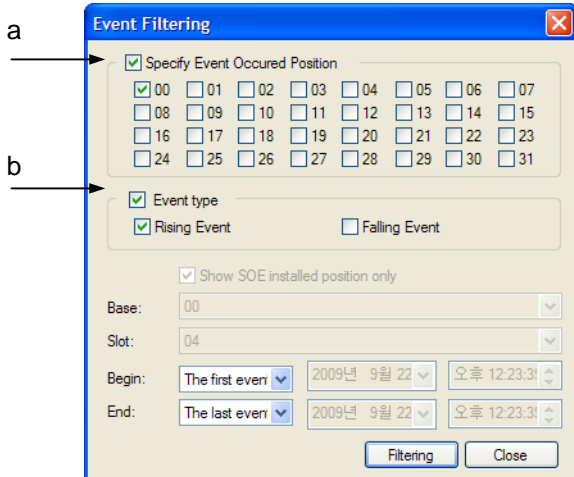

### Filtering result

	Time	Base	Slot	Contact type	Contact position	Input Status
0	2009-09-22 11:54:35.873	00	04	Rising	00	1111 1111 1111 1111 1111 1111 1111
1	2009-09-22 11:54:36.045	00	04	Rising	00	1111 1111 1111 1111 1111 1111 1111
2	2009-09-22 12:23:05.027	00	04	Rising	00	1111 1111 1111 1111 1111 1111 1111
3	2009-09-22 12:23:05.334	00	04	Rising	00	1111 1111 1111 1111 1111 1111 1111
4	2009-09-22 12:23:05.532	00	04	Rising	00	1111 1111 1111 1111 1111 1111 1111
5	2009-09-22 12:23:06.280	00	04	Rising	00	1111 1111 1111 1111 1111 1111 1111

#0 bit  
Rise event

a. Event occurrence point setting: No. "0" bit

b. Event type setting: "Rise" event.

Select [View] -> [Filtering].

### - Base and time designation filter setting

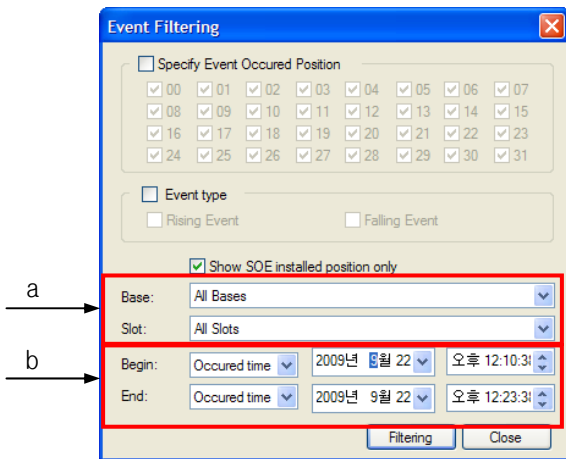

### Filtering result

	Time	Base	Slot	Contact type	Contact position	Input Status
0	2009-09-22 12:23:05.027	00	04	Rising	00	1111 1111 1111 1111 1111 1111 1111
1	2009-09-22 12:23:05.027	00	04	Rising	01	1111 1111 1111 1111 1111 1111 1111
2	2009-09-22 12:23:05.027	00	04	Rising	02	1111 1111 1111 1111 1111 1111 1111
3	2009-09-22 12:23:05.027	00	04	Rising	03	1111 1111 1111 1111 1111 1111 1111
4	2009-09-22 12:23:05.027	00	04	Rising	04	1111 1111 1111 1111 1111 1111 1111
5	2009-09-22 12:23:05.027	00	04	Rising	05	1111 1111 1111 1111 1111 1111 1111
6	2009-09-22 12:23:05.027	00	04	Rising	06	1111 1111 1111 1111 1111 1111 1111
7	2009-09-22 12:23:05.027	00	04	Rising	07	1111 1111 1111 1111 1111 1111 1111
8	2009-09-22 12:23:05.027	00	04	Rising	08	1111 1111 1111 1111 1111 1111 1111
9	2009-09-22 12:23:05.027	00	04	Rising	09	1111 1111 1111 1111 1111 1111 1111
10	2009-09-22 12:23:05.027	00	04	Rising	10	1111 1111 1111 1111 1111 1111 1111
11	2009-09-22 12:23:05.027	00	04	Rising	11	1111 1111 1111 1111 1111 1111 1111
12	2009-09-22 12:23:05.027	00	04	Rising	12	1111 1111 1111 1111 1111 1111 1111
13	2009-09-22 12:23:05.027	00	04	Rising	13	1111 1111 1111 1111 1111 1111 1111
14	2009-09-22 12:23:05.027	00	04	Rising	14	1111 1111 1111 1111 1111 1111 1111
15	2009-09-22 12:23:05.027	00	04	Rising	15	1111 1111 1111 1111 1111 1111 1111

Base/slot  
Event time  
(2009.9.22 12:23)

a. Base/Slot: designate all the bases and slots

b. Begin/End setting: 2009.4.26.3.42.12~:2009.4.26.5.44.12



## Chapter 19 Exclusive Functions for Event Input Module

### 4. Priority to the last/first

- Priority to the recent events: the recent events have priority over the old events in the display list.
- Priority to old events: the old events have priority over the recent events in the display list.

[Sequence]

- a. Select [View] -> [Newest first].

[Dialog]

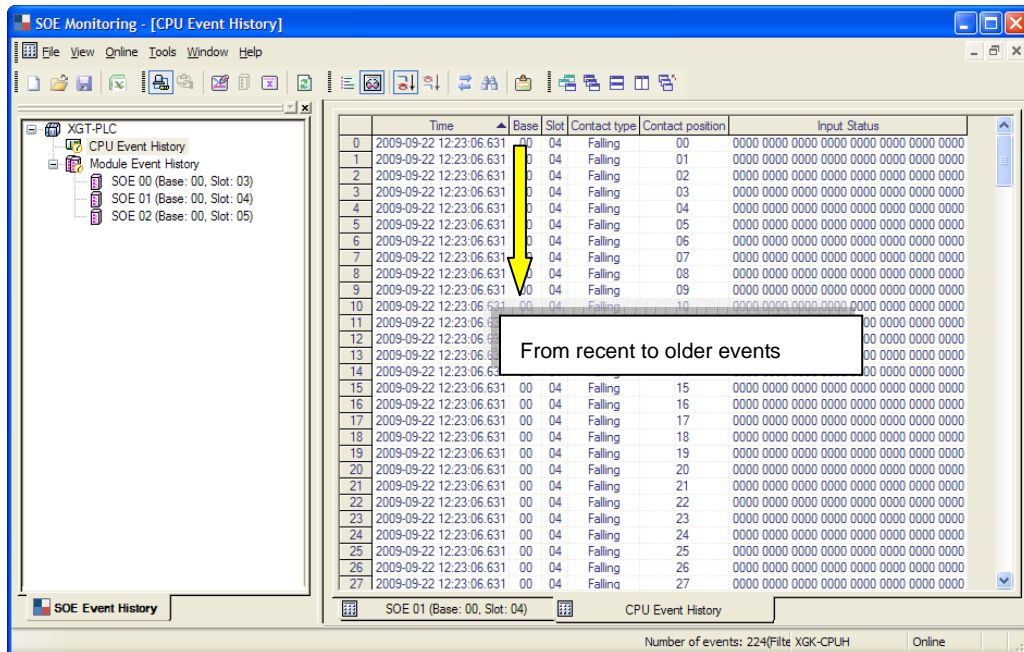

# Chapter 19 Exclusive Functions for Event Input Module

[Sequence]

- a. Select [View] -> [Oldest first].

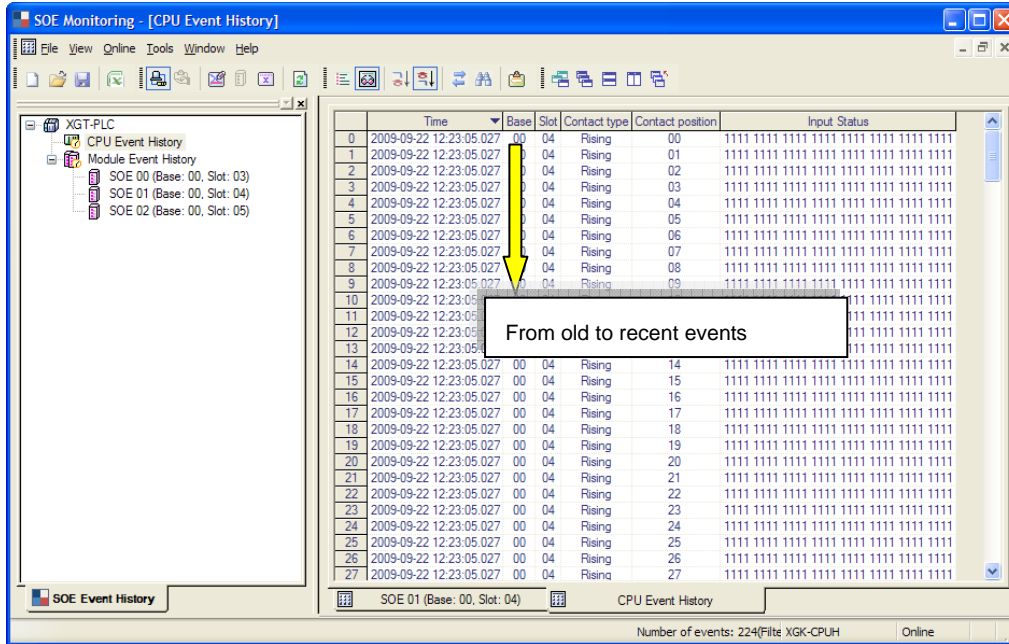

## 5. Event Comparison

Compare the events stored in the CPU and event input modules and show the result.

[Sequence]

- a. Select [View] -> [Compare Event].

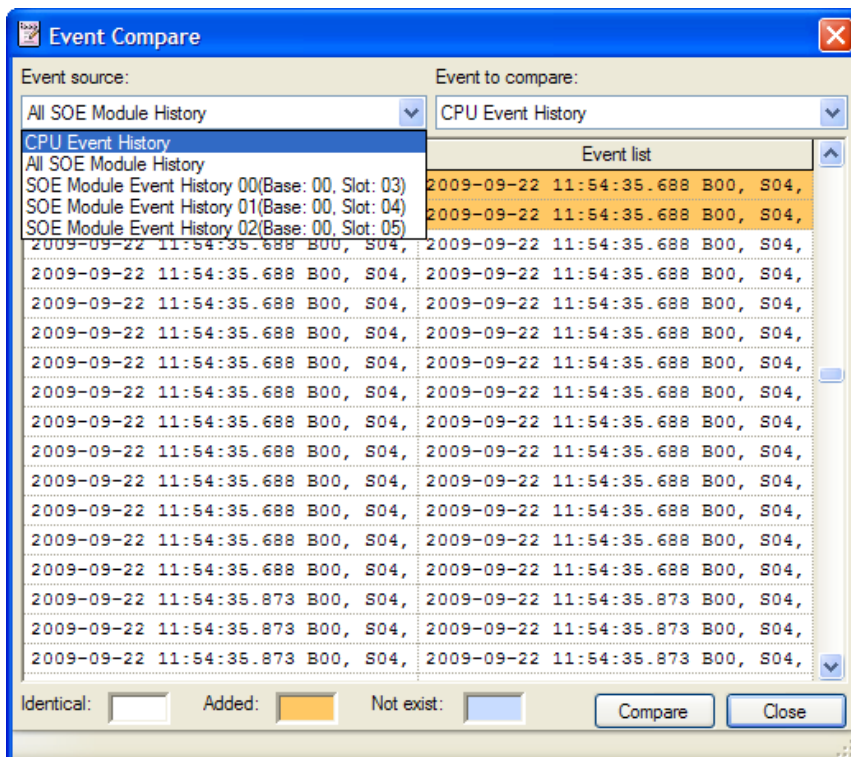

## Chapter 19 Exclusive Functions for Event Input Module

### 6. Delete Event History

Delete CPU history: the history stored in the CPU module is deleted.

[Sequence]

a. Select [Online] -> [Clear PLC Event History].

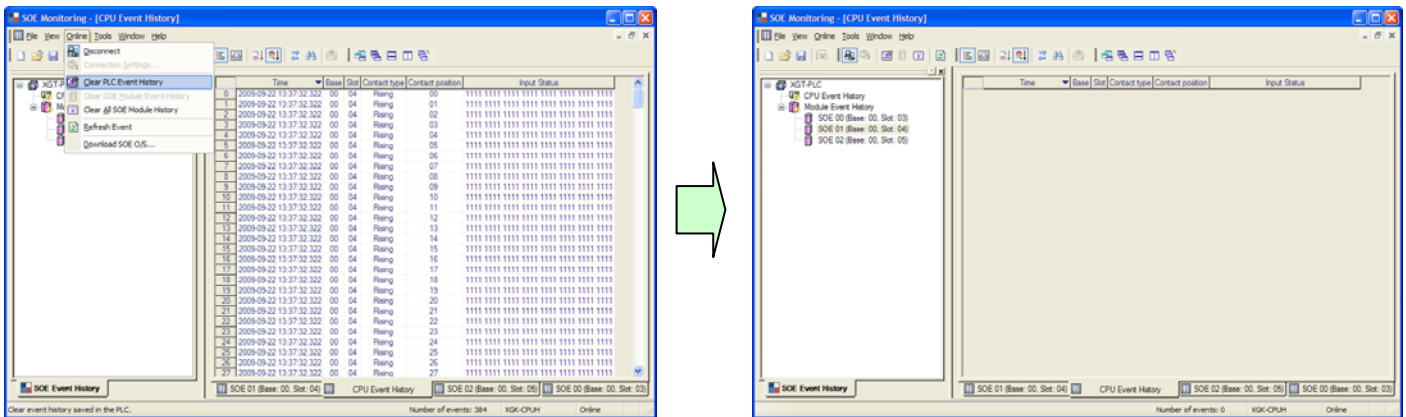

Clear SOE module event history: delete the history stored in the module.

[Sequence]

a. Select [Online] -> [Clear SOE Module Event History].

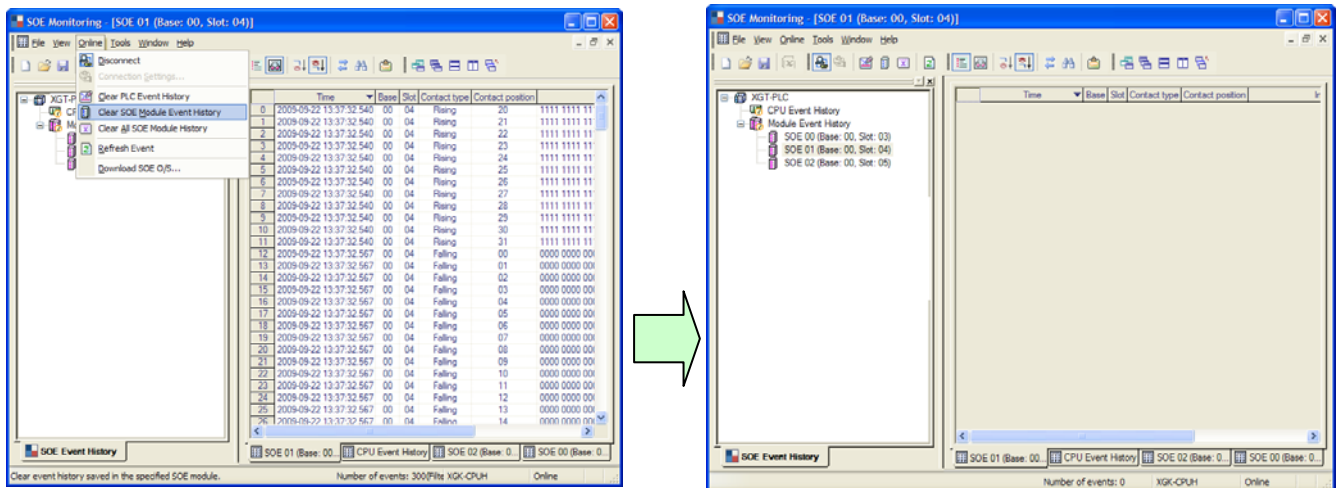

## Chapter 19 Exclusive Functions for Event Input Module

Clear All SOE module History: delete the history stored in all the SOEA modules.

[Sequence]

a. Select [Online] -> [Clear All SOE module History].

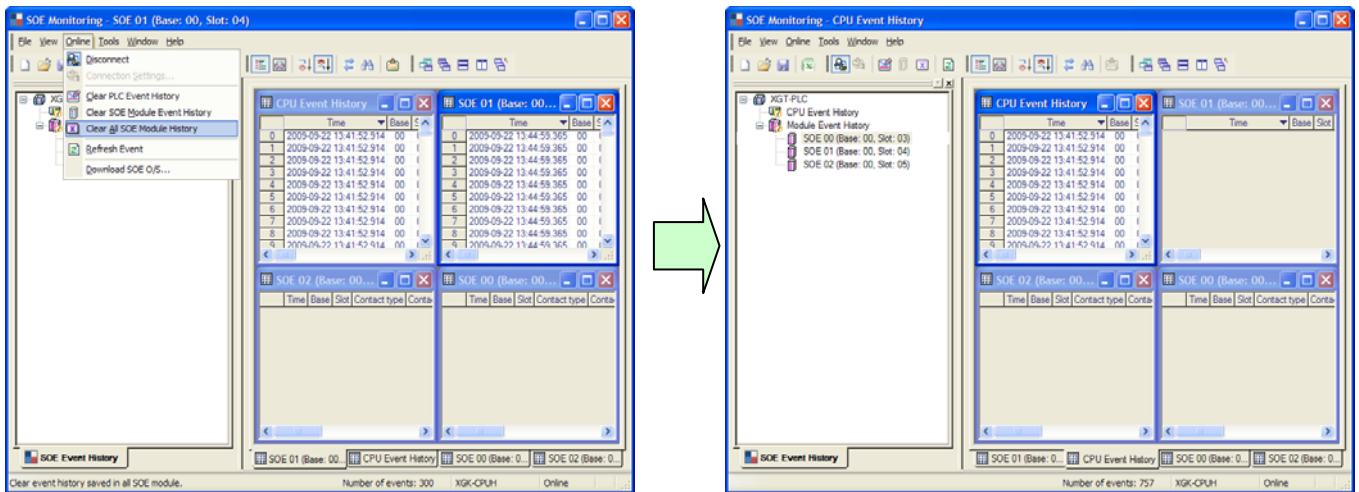

### 19.7 Save as an Excel File

This section describes how to save an event file as an Excel file.

#### 1) Save as an Excel file

The event file is saved as an Excel file.

[Sequence]

1. Select the event history to be converted into an Excel file in the event monitor window.
2. Select [File]-[Export to file] from the menu.
3. Enter a new file name in the Save As dialog.
4. Click on the Save button to create a new Excel file.

[Dialog]

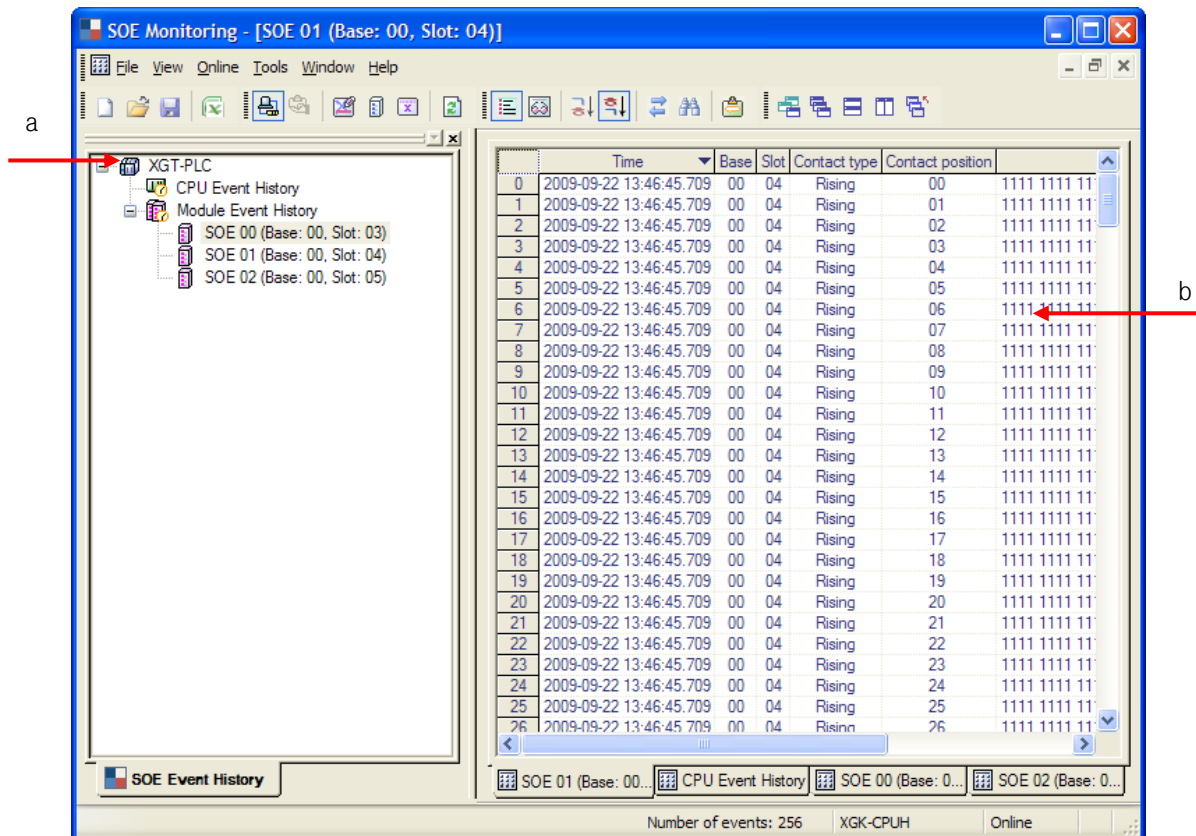

## Chapter 19 Exclusive Functions for Event Input Module

[Dialog] description;

- a. SOEA event history window: show the elements of the current project.
- b. Event monitor window: show the event data of the selected module of the project.

This conversion to an Excel file is effective only for the currently active main screen (one window).

2) [File]-[Export to file]

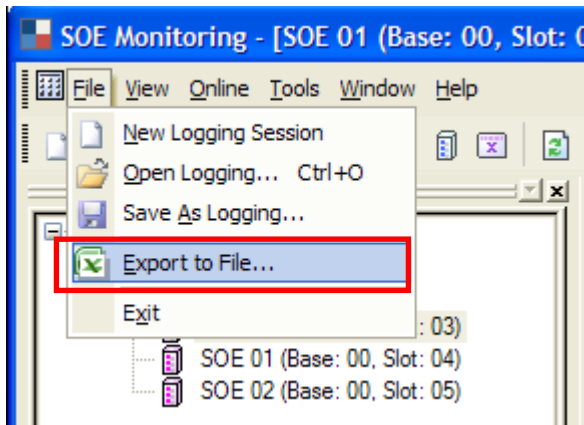

3) Enter a new file name in the Save As dialog.

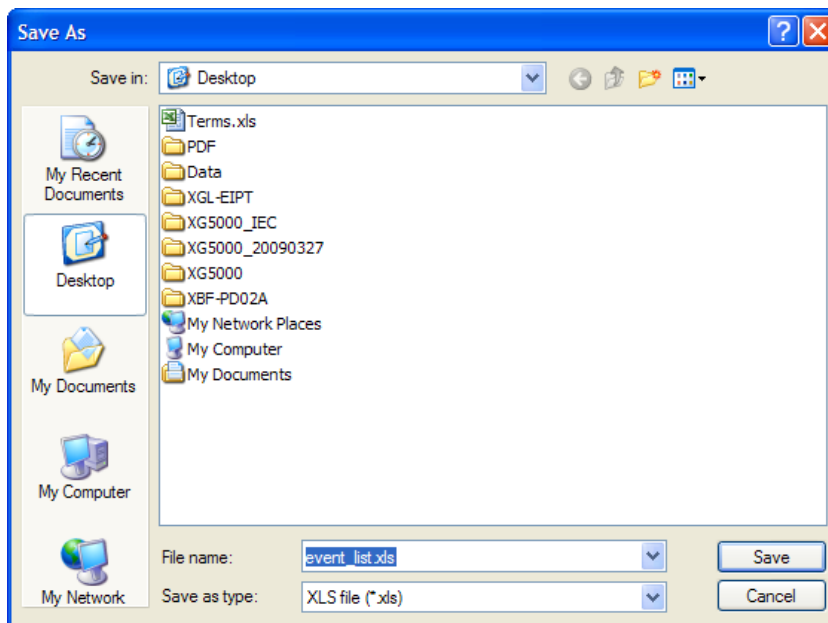

## Chapter 19 Exclusive Functions for Event Input Module

- 4) Click on the Save button to create a new Excel file.
- 5) Open file in the Excel application (to read the saved event file in Excel)

E25		Rising							
1	A	B	C	D	E	F	G		
	Time	Base	Slot	Contact type	Contact position	Input Status			
2	0	'2009-09-22 13:46:45.709	0	4	Rising	0	1111	1111	1111
3	1	'2009-09-22 13:46:45.709	0	4	Rising	1	1111	1111	1111
4	2	'2009-09-22 13:46:45.709	0	4	Rising	2	1111	1111	1111
5	3	'2009-09-22 13:46:45.709	0	4	Rising	3	1111	1111	1111
6	4	'2009-09-22 13:46:45.709	0	4	Rising	4	1111	1111	1111
7	5	'2009-09-22 13:46:45.709	0	4	Rising	5	1111	1111	1111
8	6	'2009-09-22 13:46:45.709	0	4	Rising	6	1111	1111	1111
9	7	'2009-09-22 13:46:45.709	0	4	Rising	7	1111	1111	1111
10	8	'2009-09-22 13:46:45.709	0	4	Rising	8	1111	1111	1111
11	9	'2009-09-22 13:46:45.709	0	4	Rising	9	1111	1111	1111
12	10	'2009-09-22 13:46:45.709	0	4	Rising	10	1111	1111	1111
13	11	'2009-09-22 13:46:45.709	0	4	Rising	11	1111	1111	1111
14	12	'2009-09-22 13:46:45.709	0	4	Rising	12	1111	1111	1111
15	13	'2009-09-22 13:46:45.709	0	4	Rising	13	1111	1111	1111
16	14	'2009-09-22 13:46:45.709	0	4	Rising	14	1111	1111	1111
17	15	'2009-09-22 13:46:45.709	0	4	Rising	15	1111	1111	1111

---

## Warranty

### 1. Terms of warranty

LSIS provides an 18-month warranty starting from the date of production.

### 2. Range of warranty

For problems within the terms of the warranty, LSIS will replace the entire PLC or repair the defective parts free of charge except for the following cases.

- (1) Problems caused by improper conditions, environment or treatment.
- (2) Problems caused by external devices.
- (3) Problems caused by the user remodeling or repairing the PLC.
- (4) Problems caused by improper use of the product.
- (5) Problems caused by circumstances where the expectations exceed that of the science and technology level when LSIS produced the product.
- (6) Problems caused by natural disaster.

### 3. This warranty is limited to the PLC itself only. It is not valid for the whole system which the PLC is attached to.





**LS values every single customers.  
Quality and service come first at LSIS.  
Always at your service, standing for our customers.**

<http://eng.lsis.biz>

**LS** Industrial Systems

10310000834

■ **HEAD OFFICE**

LS tower, Hoge-dong, Dongan-gu, Anyang-si, Gyeonggi-do  
1026-6, Korea <http://eng.lsis.biz> e-mail: [cshwang@lsis.biz](mailto:cshwang@lsis.biz)  
Tel. (82-2)2034-4689, 4888 Fax.(82-2)2034-4648

■ **LS Industrial Systems Tokyo Office >> Japan**

Address: 16F, Higashi-Kan, Akasaka Twin Towers 17- 22,  
2-chome, Akasaka, Minato-ku, Tokyo 107-8470, Japan  
Tel: 81-3-3582-9128 Fax: 81-3-3582-2667

e-mail: [jschuna@lsis.biz](mailto:jschuna@lsis.biz)

■ **LS Industrial Systems Dubai Rep. Office >> UAE**

Address: P.O.BOX-114216, API World Tower, 303B, Sheikh  
Zayed road, Dubai, UAE. e-mail: [hwvim@lsis.biz](mailto:hwvim@lsis.biz)  
Tel: 971-4-3328289 Fax: 971-4-3329444

■ **LS-VINA Industrial Systems Co., Ltd. >> Vietnam**

Address: LSIS VINA Congty che tao may dien Viet-Hung  
Dong Anh Hanoi, Vietnam e-mail: [srio@hn.vnn.vn](mailto:srio@hn.vnn.vn)  
Tel: 84-4-882-0222 Fax: 84-4-882-0220

■ **LS Industrial Systems Hanoi Office >> Vietnam**

Address: Room C21, 5th Floor, Horizon Hotel, 40 Cat Linh,  
Hanoi, Vietnam  
Tel: 84-4-736-6270/1 Fax: 84-4-736-6269

■ **Dalian LS Industrial Systems co., Ltd. >> China**

Address: No. 15 Liaohehexi 3 Road, economic and technical  
development zone, Dalian, China e-mail: [lixk@lsis.com.cn](mailto:lixk@lsis.com.cn)  
Tel: 86-411-8273-7777 Fax: 86-411-8730-7560

■ **LS Industrial Systems (Shanghai) Co., Ltd. >> China**

Address: Room E-G, 12th Floor Huamin Empire Plaza,  
No. 726, West Yan'an Road, Shanghai, China  
Tel: 86-21-5237-9977

■ **LS Industrial Systems(Wuxi) Co., Ltd. >> China**

Address: 102-A National High & New Tech Industrial  
Development Area, Wuxi, Jiangsu, China e-mail: [Xugh@lqis.com.cn](mailto:Xugh@lqis.com.cn)  
Tel: 86-510-534-6666 Fax: 86-510-522-4078

■ **LS Industrial Systems Beijing Office >> China**

Address: B-tower 17th Floor, Beijing Global Trade Center building,  
No. 36, BeiSanHuanDong-Lu, DongCheng-District, Beijing, China  
Tel: 86-10-5825-6025

■ **LS Industrial Systems Guangzhou Office >> China**

Address: Room 1403, 14F, New Poly Tower, 2 Zhongshan Liu  
Rad, Guangzhou, China e-mail: [zhangch@lqis.com.cn](mailto:zhangch@lqis.com.cn)  
Tel: 86-20-8326-6754 Fax: 86-20-8326-6287

■ **LS Industrial Systems Chengdu Office >> China**

Address: Room 2907, Zhong Yin B/D, No. 35, Renminzhong(2)-  
Road, Chengdu, China e-mail: [hongkonk@vip.163.com](mailto:hongkonk@vip.163.com)  
Tel: 86-28-8612-9151 Fax: 86-28-8612-9236

■ **LS Industrial Systems Qingdao Office >> China**

Address: 12th Floor, Guodong building, No52 Jindun Road,  
Chengdu, China e-mail: [bellkuk@hanmail.net](mailto:bellkuk@hanmail.net)  
Tel: 86-532-580-2539 Fax: 86-532-583-3793

※ LS Industrial Systems constantly endeavors to improve its product so that  
Information in this manual is subject to change without notice.

© LS Industrial Systems Co., Ltd 2009 All Rights Reserved.

2009. 10