

Variable Frequency Drive / Inverter **Starvert iH**

30 - 55kW(40 - 75HP) 3 phase 200 - 230Volts
30 - 220kW(40 - 300HP) 3 phase 380 - 400Volts, 440 - 460Volts



Automation Equipment





Contents

Overview	02
Features & Selection Guide	04
Specifications	06
Wiring & Terminal Configuration	08
Keypad & Procedure of Setting Data	10
Program Parameter Descriptions	12
Dimension & Braking unit	16
Driveview 2.0 & Peripheral devices & RFI Filters	18



**Dual rated iH,
fits for HVAC applications
with Space Vector Control.**

Standard features

- KW / Voltage Ratings:
 - 30-55kW, 200-230VAC, 3 phase
 - 30-220kW, 380-460VAC, 3 phase
- Inverter Type : PWM with IGBT
- CPU : 32bits high speed DSP
- Control method: Volts/Hertz with Space Vector PWM Technology
- CT, VT dual ratings
- Enclosure : IP00
- 2-10kHz Carrier Frequency
- 0.5-400 Output Frequency
- Removable Keypad(Able to read & write parameters)
- 6 Multi-function Inputs
- 5 Multi-function Outputs (3 Open-collectors, 2 Relays)
- 4-20mA Analog Output
- DC Injection Braking

Options

- Dynamic Braking Units
- Communication Board
 - RS485
 - F-Net
 - ModBus-RTU
 - Device Net
 - Profibus
 - Window based operating software(Driveview 2.0)

Application

- Fan/Blower
- Water/Waste Water Pump
- Conveyor
- Parking System
- Material Handling
- Industrial Washing Machine
- Packaging machine

Conformity to global standards

- UL and cUL listed for North America
- CE marked for Europe
- Quality process controlled by ISO9001, ISO14000



Space vector PWM technology

The Space vector technology is being adopted in all LS drives. It features outstanding performance in its control characteristics. It has low total harmonic distortion, low current ripple, low torque ripple, low motor temperature rise, and better voltage utilization. It is a basic control platform of the iH. The advantages of Space vector PWM technology are being provided in many applications.

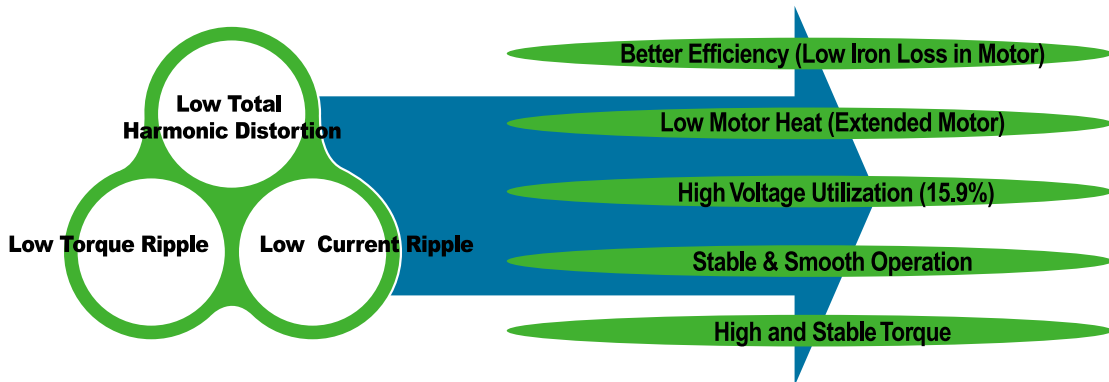

Built-in PI control

It is valuable in process control. The built-in PI controller controls flow, temperature, pressure, etc. through the proportional and integral calculus between the feedback value and reference value in closed loop.

Convenient and Various Communication Interface

The iH can be operated with communication interface such as RS485, ModBus-RTU, DeviceNet, Profibus, and F-Net, in order to be operated in various circumstances. Driveview 2.0 software is a Window based tool that provides convenience of monitoring and controlling to user. The Driveview 2.0 features a graph monitor, keypad emulator, parameter editor, and text monitor, to help user's monitoring and controlling of drive. It is applicable for all LS drives.

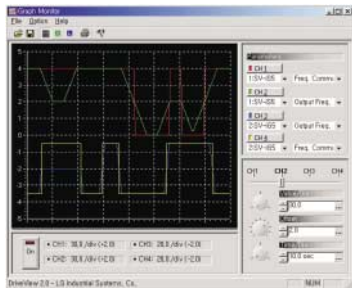

F-Net™
ModBus-RTU™
DeviceNet™
RS-485

CT / VT Dual Ratings

The iH features dual ratings in order to be used in both of constant torque and variable torque load conditions. User can pick the most suitable drive through dual ratings for various load conditions. In that way, user can be prevented from using an overpowered drive.

User friendly easy straight line programming

The iH has simple grouping programming flow. It enables quick and easy parameter change and monitoring through 32 character two line LCD display keypad.

High torque in overall speed range

The iH has 150% torque at low speed. Thus, its torque performance is proved in high duty applications.

Drive rating selection guide

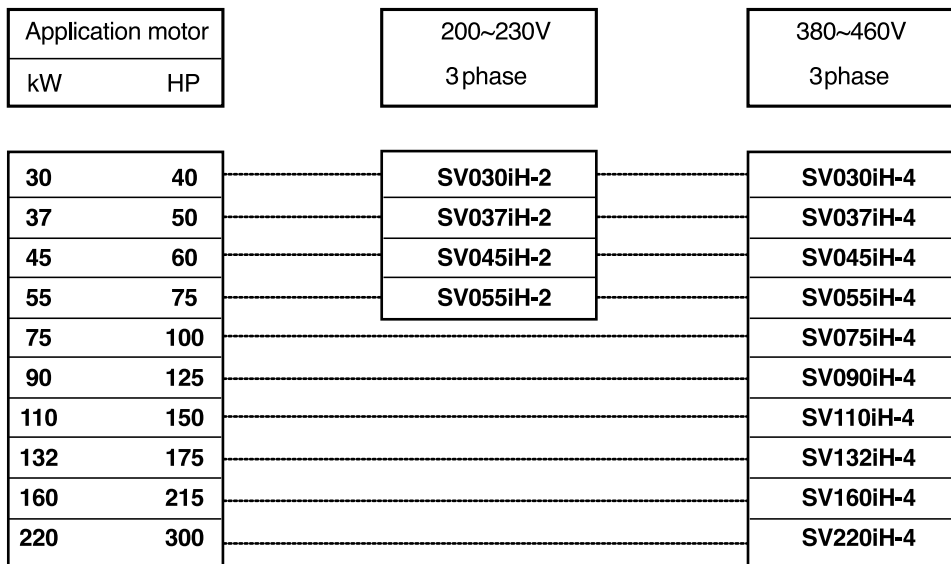

Drive type nomenclature

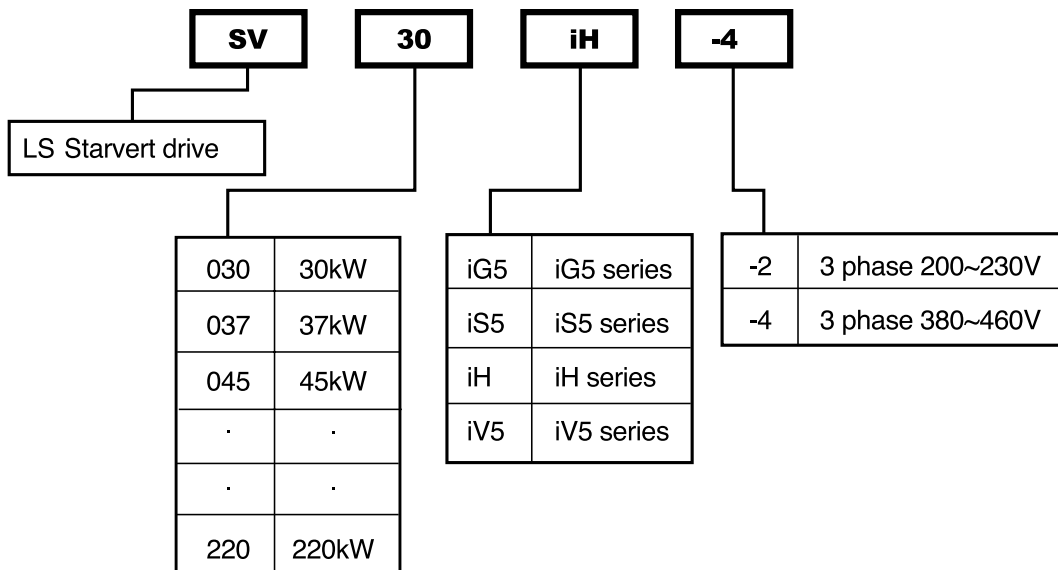

Specifications 200 ~ 230V Class(40~ 75HP)

Type		SV030iH-2	SV037iH-2	SV045iH-2	SV055iH-2
Motor rating ^{*1)}	Constant Torque [HP]	40	50	60	75
	Constant Torque [kW]	30	37	45	55
Output ratings	Constant Torque FLA [A]	46	55	68	83
	Constant Torque [kVA] ^{*2)}	122	146	180	220
Input ratings	Voltage	3phase, 200to 230V(±10%)			
	Frequency	50 to 60Hz(±5%)			
Weight[kg(lbs)]		42(93)	42(93)	56(123)	56(123)

Specifications 380 ~ 400V Class(40~ 300HP)

Type		SV030iH-4	SV037iH-4	SV045iH-4	SV055iH-4	SV075iH-4
Motor rating ^{*1)}	Constant Torque [HP]	40	50	60	75	100
	Constant Torque [kW]	30	37	45	55	75
	Variable Torque [HP]	50	60	75	100	125
	Variable Torque [kW]	37	45	55	75	90
Output ratings	Constant Torque FLA [A]	61	75	91	110	152
	Constant Torque [kVA] ^{*3)}	40	50	60	70	100
	Variable Torque FLA [A]	80	96	115	125	160
	Variable Torque [kVA] ^{*3)}	52	62	74	80	103
Input ratings	Voltage	3phase, 380 to 400V(± 10%)				
	Frequency	50 to 60Hz(±5%)				
Weight[kg(lbs)]		45(99)	45(99)	63(139)	63(139)	68(150)

Type		SV090iH-4	SV110iH-4	SV132iH-4	SV160iH-4	SV220iH-4
Motor Rating ^{*1)}	Constant Torque [HP]	125	150	175	215	300
	Constant Torque [kW]	90	110	132	160	220
	Variable Torque [HP]	150	175	215	250	350
	Variable Torque [kW]	110	132	160	185	280
Output ratings	Constant Torque FLA [A]	183	223	264	325	432
	Constant Torque [kVA] ^{*3)}	120	145	170	200	280
	Variable Torque FLA [A]	228	264	330	361	477
	Variable Torque [kVA] ^{*3)}	147	170	213	233	307
Input ratings	Voltage	3phase, 380 to 400V(± 10%)				
	Frequency	50 to 60Hz(±5%)				
Weight[kg(lbs)]		98(216)	98(216)	122(269)	122(269)	175(386)

Specifications 440 ~ 460V Class(40~ 300HP)

Type		SV030iH-4	SV037iH-4	SV045iH-4	SV055iH-4	SV075iH-4
Motor rating ^{*1)}	Constant Torque [HP]	40	50	60	75	100
	Constant Torque [kW]	30	37	45	55	75
	Variable Torque [HP]	50	60	75	100	125
	Variable Torque [kW]	37	45	55	75	90
Output ratings	Constant Torque FLA [A]	61	75	91	110	152
	Constant Torque [kVA] ^{*4)}	45	56	68	82	113
	Variable Torque FLA [A]	80	96	115	125	160
	Variable Torque [kVA] ^{*4)}	60	70	86	93	120
Input ratings	Voltage	3phase, 440 to 460V(± 10%)				
	Frequency	50 to 60Hz(±5%)				
Weight[kg(lbs)]		45(99)	45(99)	63(139)	63(139)	68(150)

*1) Indicates the maximum applicable capacity when using a 4 Pole motor.

*2) Rated kVA ($\sqrt{3} \cdot V \cdot I$) is based on 220V.

*3) Rated kVA ($\sqrt{3} \cdot V \cdot I$) is based on 380V.

*4) Rated kVA ($\sqrt{3} \cdot V \cdot I$) is based on 440V.

Type	SV090iH-4	SV110iH-4	SV132iH-4	SV160iH-4	SV220iH-4	
Motor rating ^{*1)}	Constant Torque [HP]	125	150	175	215	300
	Constant Torque [kW]	90	110	132	160	220
	Variable Torque [HP]	150	200	250	300	350
	Variable Torque [kW]	110	132	185	220	280
Output ratings	Constant Torque FLA [A]	183	223	264	325	432
	Constant Torque [kVA] ^{*4)}	136	166	197	242	322
	Variable Torque FLA [A]	228	264	330	361	477
	Variable Torque [kVA] ^{*4)}	170	200	246	270	356
Input ratings	Voltage	3phase, 440 to 460V(±10%)				
	Frequency	50 to 60Hz(±5%)				
Weight[kg(lbs)]	98(216)	98(216)	122(269)	122(269)	175(386)	

Common Specifications

Output ratings	Max. Frequency	0.5 to 400 Hz
	Output Voltage	3 Phase, 0 to Input Voltage
Control	Control Method	Space Vector PWM
	Frequency Setting Resolution	Digital Reference: 0.01 Hz (Below 100Hz), 0.1 Hz (Over 100Hz) Analog Reference: 0.03 Hz / 60Hz
	Frequency Accuracy	Digital: 0.01% of Maximum Output Frequency Analog: 0.1% of Maximum Output Frequency
	V/F Ratio	Linear, Non-Linear, User Programmable
	Braking Torque (w/o DB)	About 20%
	Overload Capacity CT	150% of Rated Current for 1 Minute, 200% for 0.5 Second
	Overload Capacity VT	110% of Rated Current for 1 Minute, 150% for 0.5 Second
	Torque Boost	Manual Torque Boost (0 to 20%), Auto Torque Boost
Operating	Operation Method	Keypad / Terminal / Remote (Optional)
	Frequency Setting	Analog: 0 to 10 V / 4 to 20mA, Digital: Keypad
	Accel / Decel Time	0.1 to 6,000 sec, 8 Pre-Defined (Programmable)
	Multi-Step	8 Preset Operational Speed
	Jog	Jog Operation
	Operating Function	DC Braking, Frequency Limit, Frequency Jump, Slip Compensation, PI Control, Stall Prevention
	Operating Status	Frequency Detection Level, Overload Alarm, Stalling, Over Voltage, Under Voltage, Drive Overheat, Run, Stop, Constant Speed, Speed Searching
	Start Signal	Forward, Reverse
Programmable I/O	Programmable Input	6 Programmable Inputs
	Programmable Output	5 Programmable Outputs: 2 Form A Contact (N.O.) Fault Contact Output (A, C, B) - 250VAC 1A, 30VDC 1A 3 Open Collector Outputs: 24V, 50mA
	Analog	4 ~ 20mA
	Meter	RPM, Hz, Current, Voltage (Output Pulse: 500Hz, Output Voltage: 0 ~ 10V)
Protective Functions	Drive Trip	Over Voltage, Under Voltage, Over Current, Drive Overload, Fuse Open, Ground Fault, Drive Overheat, Motor Overheat, Main CPU Error.
	Stall Prevention	Over Current Prevention
	Instant Power Loss	Less Than 15msec: Continuous Operation, More Than 15msec: Auto Restart (Programmable)
Operating Conditions	Ambient Temp.	14°F ~ 104°F (-10°C ~ 40°C), CE Certification: 41°F ~ 104°F (5°C ~ 40°C)
	Storage Temp.	-4°F ~ 149°F (-20°C ~ 65°C)
	Humidity	90% RH Max. (Non-Condensing), CE Certification: 5 ~ 85% (Non-Condensing)
	Altitude - Vibration	Below 3,300ft (1,000m) · Below 5.9m/sec ² (0.6 g)
	Air Pressure	86 ~ 106kPa
	Application Site	No corrosive gas, combustible gas, oil mist, or dust
	Cooling Method	Forced Air Cooling
	Enclosure	IP00
International Standards	CE Certified, UL Listed (UL508C)	

Wiring

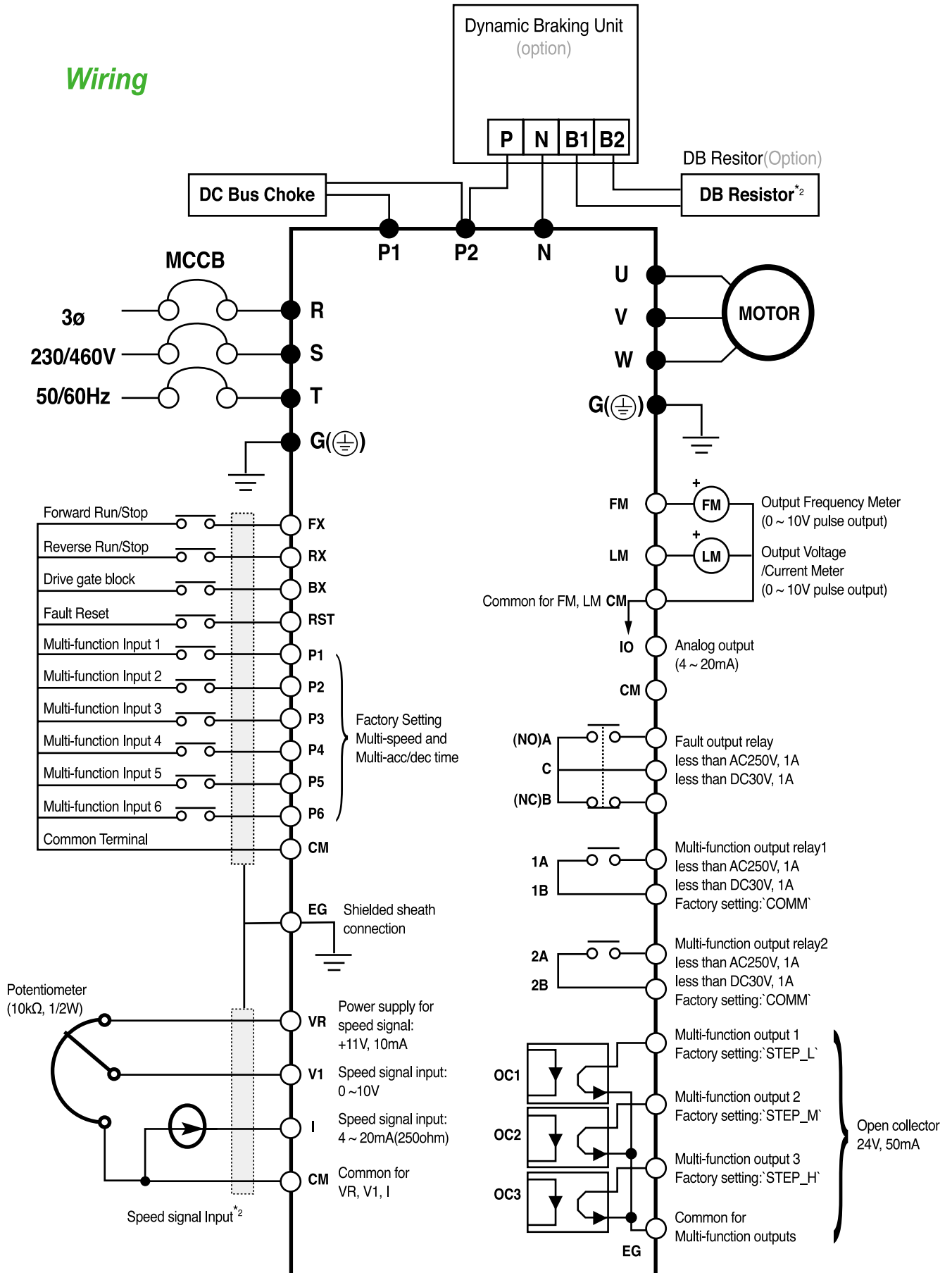

Note) * Main circuit terminals, "o" Control circuit terminals.

1. Analog speed command can be set by Voltage, Current and both of them.

2. When installing the DC Reactor, the Common Busbar between P1 and P2 must be removed.

Power terminal configuration

- 200 - 230V Class



- 380 - 460V Class



Symbols	Functions
R S T	AC Line input (3 phase 200~230 VAC or 380 ~ 460 VAC)
G	Earth Ground
P1 P2	Positive DC Bus Terminal External DC Reactor(P1-P2) and DB Unit(P2-P ⁺) connection terminals
N	Negative DC Bus Terminal DB Unit(N-N) connection terminal
U V W	3-Phase power output terminals to motor(3phase, 200 ~230VAC or 380 ~ 460VAC)

"Suitable for use on a circuit capable of delivering not more than 10,000 rms symmetrical amperes, 240 volts maximum for 230V class models and 480 volts maximum for 460V class models."

Control terminal configuration

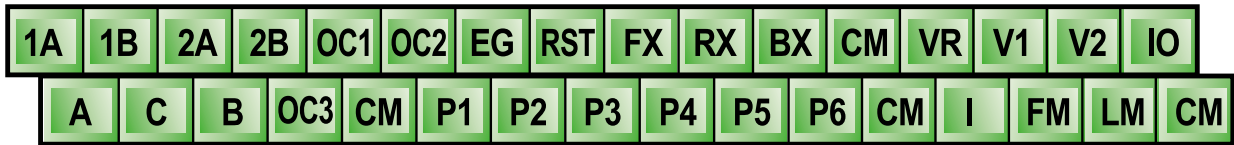

Type	Symbol	Name	Description
Input signal	Starting Contact Function Selection	P1 ~ P6	Multi-function input 1 ~ 6 Used for multi-function input terminal.
		FX	Forward run command Forward run when closed and stopped when open.
		RX	Reverse run command Reverse run when closed and stopped when open.
		BX	Drive gate block When the BX signal is ON the output of the drive is turned off. When motor uses a mechanical brake to stop, BX is used to turn off the output signal. When BX signal is OFF (not turned off by latching) and FX signal (or RX signal) is ON, motor continues to run.
		RST	Fault reset Used for fault reset.
	Analog Frequency Setting	CM	Sequence common Common terminal for contact inputs.
		VR	Frequency setting power (+10V) Used as power for analog frequency setting. Maximum output is +12V, 10mA.
		V1	Frequency reference (Voltage) Used for 0-10V input frequency reference. Input resistance is 20kΩ
		V2	Frequency reference (Current) Used for 4-20mA Input frequency reference. Input resistance is 250Ω
		I	Frequency setting common terminal Common terminal for analog frequency setting
Output signal	Pulse	FM	Frequency output(For external monitoring) Outputs PWM signal according to drive output frequency. Maximum output voltage and output current are 0-12V and 1mA.
		LM	Current/Voltage output(For external monitoring) Outputs one of the following: output current, output voltage. Default is set to output voltage. Maximum output voltage and output current are 0-12V and 1mA. Output frequency is set at 1.8kHz.
	Analog	IO	Frequency output (4 ~ 2mA) Outputs analog signal according to inverter output frequency.
	Contact	A, C, B	Fault output relay Activates when protective function is operating. AC250V, 1A or less; DC30V, 1A or less. Fault: 30A-30C closed (30B-30C open) Normal: 30B-30C closed (30A-30C open)
		1A-1B, 2A-2B	Multi-function output relay 1 and 2 (AUX1, AUX2) Use after defining multi-function output terminal. AC250V, 1A or less; DC30V, 1A or less.
		OC1, OC2, OC3	Multi-function open collector output Use after defining multi-function output terminal. DC24V, 50mA
	EG	Multi-function open collector output common terminal Ground terminal for OC1, OC2, OC3.	

Keypad

LCD Control Panel

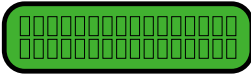

32 Character, back lit, **LCD display**.
The backlight is adjustable.

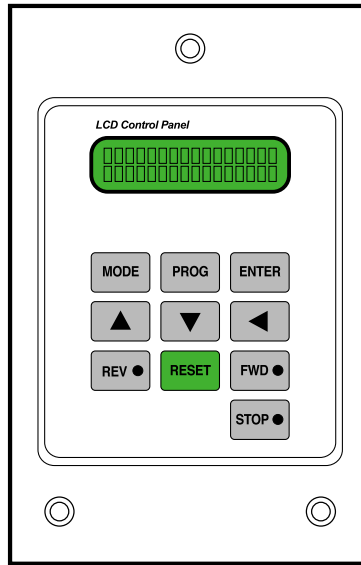

The **Mode Button** moves you through the three program groups : DRV, FUN, I/O



The **Up and Down Arrows** are used to search parameters and change data.



The **Reverse Run Button** blinks when the reverse drive accels or decels.



The **Program Button** is used to go into programming mode to change data.



The **Enter Button** is used to enter changed parameters.



The button is used to move cursor across the display in a programming mode.



The **Forward Run Button** blinks when the forward drive accels or decels.



The **Stop Button** blinks when there is a fault.



The **Reset Button** is used to reset faults.

Parameter groups

Group name	LCD Keypad(Upper Left Coner)	Description
Drive Group	DRV	Command frequency, Accel/Decel time Etc. Basic parameters
Function Group	FUN	Maximum frequency, amount of torque boost etc. Basic Related Parameters
Input/Output Group	I/O	Multi-Function terminal settings. Parameters needed for sequence operation

Operation method

Operation Method	Function	Function Setting
Operation using keypad	Run/Stop command and frequency are set only through the keypad.	FUN 01: Key
		FUN 02: Key
Operation using Control Terminals	Closing FX or RX terminal performs Run/Stop.	FUN 01: Terminal
	Frequency reference is set through V1 or I terminal.	FUN 02: Terminal-1 or Terminal-2
Operation using both Keypad and Control Terminals	Run/Stop is performed by the keypad. Frequency reference is set through the V1 or I terminal.	FUN 01: Terminal
	Closing FX or RX terminal performs Run/Stop. Frequency reference is set through the keypad.	FUN 02: Key
Option	Operation using RS485 communication between drive and computer.	FUN 01: Remote
		FUN 02: Remote
		I/O 48: RS485
Option	Operation using ModBus RTU communication between drive and PLC.	FUN 01: Remote
		FUN 02: Remote
		I/O 48: ModBus RTU
Option	Operation using FNet communication between drive and computer.	FUN 01: Remote
		FUN 02: Remote
		I/O 48: FNet

Procedure of Setting Data

- To change command frequency from 30.00Hz to 45.50Hz :

PROG	DRV ▶ Manual K/K 00 REV 30.00Hz	Press PROG key and the cursor appears on the lowest digit.
◀	DRV ▶ Manual K/K 00 REV 30.00Hz	Press LEFT key once to move digit.
▲	DRV ▶ Manual K/K 00 REV 30.50Hz	Press UP key 5 time.
◀	DRV ▶ Manual K/K 00 REV 35.50Hz	Press SHIFT key once to shift the cursor to next digit.
▲	DRV ▶ Manual K/K 00 REV 35.50Hz	Press UP key 5 time.
◀	DRV ▶ Manual K/K 00 REV 45.50Hz	Press SHIFT key once to shift the cursor to next digit.
▲	DRV ▶ Manual K/K 00 REV 45.50Hz	Press UP key once to make 4.
ENTER	DRV ▶ Manual K/K 00 REV 45.50Hz	Press ENTER key to store new value.

The same procedure is applied to all other parameters. While the drive is running, the output frequency can be change to a new command frequency.

**Note : Some parameters cannot be changed while the drive is running
 (refer to the function group table in program parameter descriptions.)*

Parameter navigation

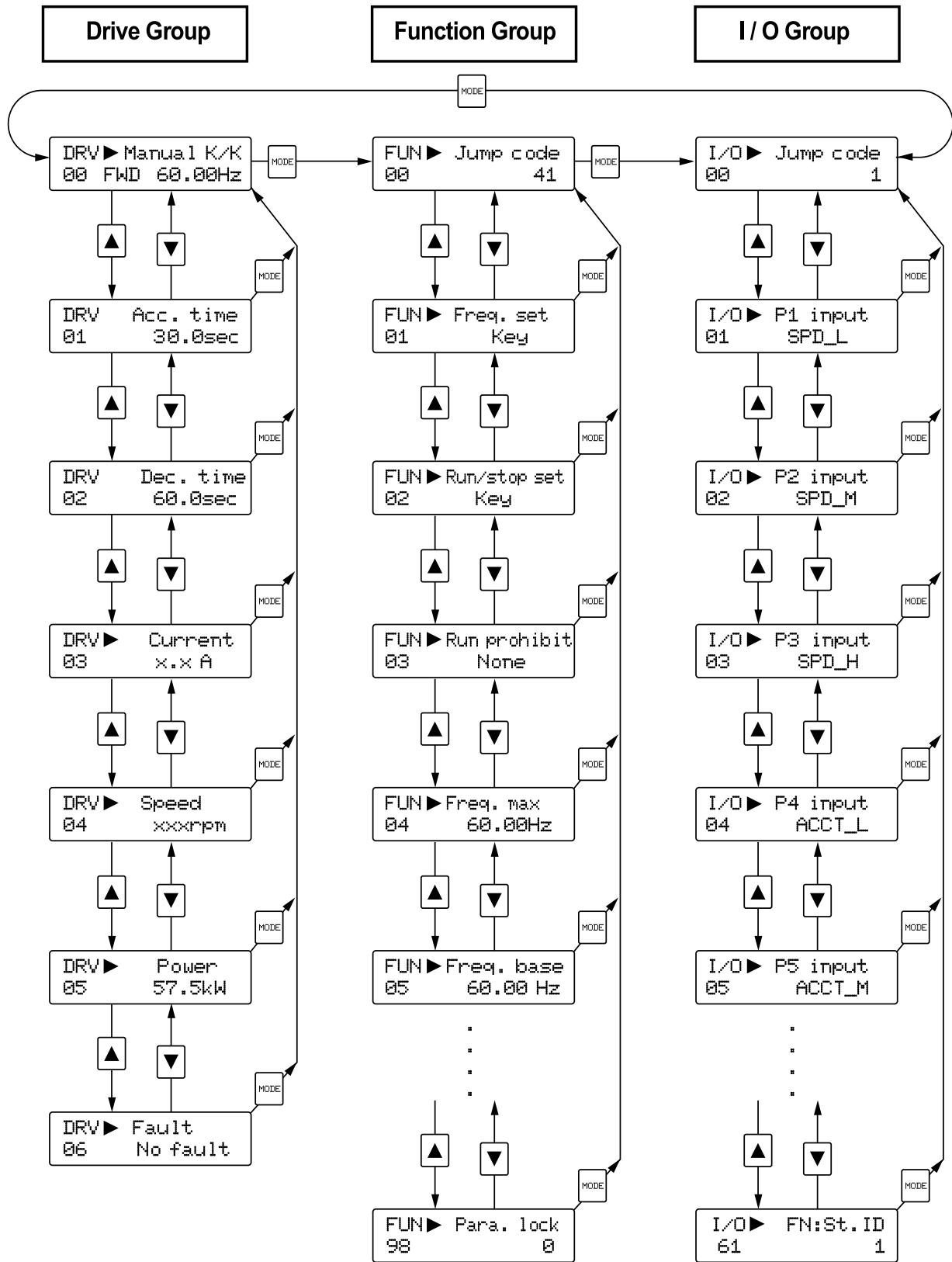

Program parameter descriptions

1. Drive Group

Code [DRV]	Description of Drive Group	Keypad Display	Setting Range	Units	Factory Default	Adjustable during run
00	Output Frequency(During Run)or Reference Frequency(During Stop)	Cmd. Freq	0 to FUN04	0.01	0.00 [Hz]	Yes
01	Acceleration Time	Acc.time	0 to 6000 [sec]	0.1	30.0 [sec]	Yes
02	Deceleration Time	Dec. time	0 to 6000 [sec]	0.1	60.0 [sec]	Yes
03	Output Current	Current	The load current in RMS	-	- [A]	-
04	Output Speed	Speed	The motor speed in RPM	-	- [rpm]	-
05	Output Power Display	Power	Inverter Output Power	-	-[kW]	-
06	Fault Display	Fault	-	-	-	-

2. Function Group

Code [FUN]	Description of Function Group	Keypad Display	Setting Range	Units	Factory Default	Adjustable during run
00	Jump to Desired Code #	Jump Code	1 to 98	1	41	Yes
01	Frequency Setting Mode	Freq.set	Key,Terminal, Remote	-	Key	No
02	Run / Stop Mode Selection	Run/Stop set	Key, Terminal-1,Terminal-2, Remote	-	Key	No
03	Run Prevention	Run prohibit	None, FWD disable, REV disable	-	None	No
04	Maximum Frequency Output Set Point	Freq.max	40 to 400 [Hz]	0.01	60 [Hz]	No
05	Base Frequency	Freq.base	40 to FUN 04	0.01	60 [Hz]	No
06	Starting Frequency	Freq.start	0.5 to 5[Hz]	0.01	0.5 [Hz]	No
07	Starting Frequency Hold Time	Hold time	0 to 10 [sec]	0.1	0.0 [sec]	Yes
08	Volts / Hz Pattern	V/F pattern	Linear, 2.0(Squared), User, Auto	-	Linear	No
09	Torque Boost in Forward Direction	Fwd boost	0 to 20 [%]	1	2 [%]	Yes
10	Torque Boost in Reverse Direction	Rev boost	0 to 20 [%]	1	2 [%]	Yes
11	Acceleration Pattern	Acc. pattern	Linear, S-curve,U-curve	-	Linear	No
12	Deceleration Pattern	Dec. pattern	Linear, S-curve,U-curve	-	Linear	No
13	Output Voltage Adjustment	Volt control	40 to 110 [%]	1	100 [%]	No
14	Energy Savings Level	Energy save	30 to 100 [%]	1	100 [%]	Yes
15	Stop Mode Selection	Stop mode	Decel, DCBR, Free Run	-	Decel	No
16	User V/F - Frequency 1	User-1f	0 to 30 [Hz]	0.01	10.00 [%]	No
17	User V/F - Voltage 1	User-1v	0 to 50 [%]	1	15 [%]	No
18	User V/F - Frequency 2	User-2f	FUN 16 to FUN 04	1	30.00 [%]	No
19	User V/F - Voltage 2	User-2v	FUN 17 to 100 [%]	1	50 [%]	No
20	Analog Speed Input Selection	V-I mode	V1, I, V1+I, V2	-	V1	No
21	Analog Speed Input Filter Gain	Filter gain	1 to 100 [%]	1	25 [%]	Yes
22	Analog Speed Input Gain	Analog gain	50 to 250 [%]	1	100 [%]	Yes
23	Analog Speed Input Bias	Analog bias	0 to 200 [%]	1	0 [%]	Yes
24	Analog Speed Input Direction	Analog dir	Direct, Invert	-	Direct	Yes
25	Frequency Limit Selection	Freq. limit	No, Yes	-	No	No
26	Frequency High Limit Selection	F-limit high	0 to FUN 04	0.01	60.00 [Hz]	No
27	Frequency Low Limit Selection	F-limit low	0 to FUN26	0.01	0.00 [Hz]	No
28	Jump Frequency Selection	Freq. jump	No, Yes	-	No	No
29	Jump Frequency 1	Freq. jump 1f	0 to FUN 04	0.01	10.00 [Hz]	No
30	Jump Frequency 2	Freq. jump 2f	0 to FUN 04	0.01	20.00 [Hz]	No
31	Jump Frequency 3	Freq. jump 3f	0 to FUN 04	0.01	30.00 [Hz]	No
32	Jump Frequency Bandwidth	Freq. band	0 to 30 [Hz]	0.01	5.00 [Hz]	No
33	DC Injection Braking Frequency	DC-br freq	0 to 60 [Hz]	0.01	0.5 [Hz]	Yes
34	DC Injection Braking On-Delay Time	DC-br block	0.5 to 5[sec]	0.1	2 [sec]	Yes
35	DC Injection Braking Time	DC-br time	0.1 to 25.0 [sec]	0.1	0.5 [sec]	Yes
36	DC Injection Braking Voltage	DC-br value	1 to 20 [%]	1	1 [%]	Yes
37	Slip Compensation	Slip compen.	No, Yes	-	No	Yes
38	Rated Motor Slip	Rated slip	0 to 5 [Hz]	0.01	0.00 [Hz]	Yes
39	Rated Motor Current (in RMS)	M-rated cur.	0.1 to 999[A]	0.1	103.0 [A] ^{*9)}	Yes
40	No Load Motor Current in RMS	No-load cur.	0.1 to 300 [A]	0.1	0.1 [A]	Yes
41	Inverter Capacity	Inv Capacity	SV030IH-2 SV037IH-2 SV220IH-4	-	SV030IH-2 ^{*10)}	No
42	Number of Auto Restart	Retry number	0 to 10	1	0	Yes
43	Delay Time Before Auto Restart	Retry time	0 to 10 [sec]	0.1	1.0[sec]	Yes
44	Fault Output Relay(A, B, C)	Relay mode	Retry0, All Trips, LV+Retry0, LV+All Trips	-	Retry 0	Yes

2. Function Group

Code [FUN]	Description of Function Group	Keypad Display	Setting Range	Units	Factory Default	Adjustable during run
45	Stall Prevention Mode	Stall mode	None, Acc, Steady, Acc + Steady, Dec, Acc + Dec, Dec + Steady, Acc + Dec+Steady	-	None	Yes
46	Stall Prevention Level	Stall level	CT: 30 to 150 [%] VT: 30 to 150 [%]	1 1	150 [%] 110 [%]	Yes Yes
47	Overload Warning Level	OL level	CT: 30 to 150 [%] VT: 30 to 110 [%]	1 1	150 [%] 110 [%]	Yes Yes
48	Overload Warning Hold Time	OL time	1 to 30 [sec]	1	10 [sec]	Yes
49	Over Current Trip Limit Level	OC lim level	CT: 30 to 200 [sec] VT: 30 to 150 [sec]	1 1	160 [%] 110 [%]	Yes Yes
50	Over Current Limit Time	OC lim. Time	0 to 60 [sec]	0.1	60 [sec]	Yes
51	Electronic Thermal Selection	ETH select	No, Yes	-	No	Yes
52	Electronic Thermal Level	ETH level	30 to 150 [%]	1	150 [%]	Yes
53	Electronic Thermal Characteristic (Motor Type) Selection	Motor type	General, Special	-	General	Yes
54	Number of Motor Poles	Pole number	2 to 12	1	4	Yes
55	IPF (Instant Power Failure) Restart Selection	IPF select	No, Yes	-	No	Yes
56	Speed Search Acceleration Time	SS acc. time	0.1 to 600 [sec]	0.1	5 [sec]	Yes
57	Speed Search Deceleration Time	SS dec. Time	0.1 to 600 [sec]	0.1	10 [sec]	Yes
58	Speed Search Gain	SS gain	0 to 200 [%]	1	100 [%]	Yes
59	Restart after Fault Reset Selection	RST-restart	No, Yes	-	No	Yes
60	Power-On Start Selection	Power on st	No, Yes	-	No	Yes
61	Carrier Frequency	Carrier Freq	2 to 10 [Hz]	1	6 [Hz] ^{*11)}	No
62	PI Control Selection	PI-control	No, Yes	-	No	No
63	PI Proportional Gain	P-gain	1 to 30000	1	10	Yes
64	PI Integral Gain	I-gain	1 to 30000	1	50	Yes
65	PI Feedback Selection	PI-fb select	I, V1, V2	-	I	No
66	PI Feedback Filter Gain	PI-fb filt.G	1 to 100 [%]	1	25 [%]	Yes
67	PI Feedback Gain	PI-fb gain	50 to 250 [%]	0.1	100.0 [%]	Yes
68	PI Feedback Bias	PI-fb bias	0 to 200 [%]	0.1	100.0 [%]	Yes
69	PI Feedback Direction	PI-fb dir	Direct, Invert	-	Direct	No
70	PII Gain Scale	I_term scale	1 to 100 [%]	1	100 [%]	Yes
71	PI Controller Error Direction	PI error dir	Direct, Invert	-	Direct	No
72	PI Control Bypass	Regul bypass	No, Yes	-	No	No
94 ^{*12)}	CT/VT Selection	CT/VT	Constant Trq, Variable Trq	-	Constant Trq	No
95	Read Parameters into Keypad from Drive	Para. Read	No, Yes	-	No	No
96	Write Parameters to Drive from Keypad	Para. Write	No, Yes	-	No	No
97	Initialize Parameters to Factory Default Settings	Para. Init	No, Yes	-	No	No
98	Parameter Write Protection	Para. Lock	0 to 255	1	0	Yes

*9) Default value depends on the drive capacity.

*10) FUN 41 is set at its drive capacity before shipping outside. However, drive loses its capacity information after parameter initialization in FUN 97.

If the parameters are initialized, be sure to re-set the drive capacity to the right capacity.

*11) Carrier Frequency according to the drive Capacity (The Carrier Frequency is set to 3kHz for VT Rating)

type	SettingRange	Factory Default	type	SettingRange	Factory Default
SV030IH+2	2 to 10	6kHz	SV075IH+4	2 to 7	6kHz
SV037IH+2	2 to 10	6kHz	SV090IH+4	2 to 6	6kHz
SV045IH+2	2 to 8	6kHz	SV110IH+4	2 to 6	6kHz
SV055IH+2	2 to 8	6kHz	SV132IH+4	2 to 5	5kHz
SV030IH+4	2 to 10	6kHz	SV160IH+4	2 to 4	4kHz
SV037IH+4	2 to 10	6kHz	SV220IH+4	2 to 4	4kHz
SV045IH+4	2 to 8	6kHz	SV315IH+4	2 to 4	4kHz
SV055IH+4	2 to 8	6kHz	SV375IH+4	2 to 4	4kHz

*12) VT is available only for 440V class inverter.

Program parameter descriptions

3. I/O Group

Code [I/O]	Description of I/O Group	Keypad Display	Setting Range	Units	Factory Default	Adjustable during run
00	Jump to Desired Code #	Jump Code	1 to 60	1	1	Yes
01	Multi-function Input 1 (P1 terminal)	P1 Input	SPD_L,SPD_M,SPD_H,	-	SPD_L	No
02	Multi-function Input 2 (P2 terminal)	P2 Input	JOG,ACCT_L,ACCT_M,	-	SPD_M	No
03	Multi-function Input 3 (P3 terminal)	P3 Input	ACCT_H,UP,DOWN,	-	SPD_H	No
04	Multi-function Input 4 (P4 terminal)	P4 Input	HOLD,DIS_OPT,	-	ACCT_L	No
05	Multi-function Input 5 (P5 terminal)	P5 Input	COMM_CONN,EXT_DCBR,	-	ACCT_M	No
06	Multi-function Input 6 (P6 terminal)	P6 Input	EXT_TRIP - SPD_L	-	ACCT_H	No
07	Multi-function Output 1 (OC1 terminal)	OC1 Output	FST_LO,FST_HI,FDT_HI,	-	STEP_L	No
08	Multi-function Output 2 (OC2 terminal)	OC2 Output	FDT_PULSE,FDT_BAND,	-	STEP_M	No
09	Multi-function Output 3 (OC3 terminal)	OC3 Output	OL,STALL,LV,RUN,COMM,	-	STEP_H	No
10	Multi-function Output 4 (Aux.1 Relay term.)	AUX1 Output	STEP_L,STEP_M,STEP_H,	-	COMM	No
11	Multi-function Output 5 (Aux. 2 Relay term.)	AUX2 Output		-	COMM	No
12	Jog Frequency	Jog freq.	0 to FUN 04	0.01	30.00 [Hz]	Yes
13	Step Speed 1	Step freq-1	0 to FUN 04	0.01	10.00 [Hz]	Yes
14	Step Speed 2	Step freq-2	0 to FUN 04	0.01	20.00 [Hz]	Yes
15	Step Speed 3	Step freq-3	0 to FUN 04	0.01	30.00 [Hz]	Yes
16	Step Speed 4	Step freq-4	0 to FUN 04	0.01	40.00 [Hz]	Yes
17	Step Speed 5	Step freq-5	0 to FUN 04	0.01	50.00 [Hz]	Yes
18	Step Speed 6	Step freq-6	0 to FUN 04	0.01	46.00 [Hz]	Yes
19	Step Speed 7	Step freq-7	0 to FUN 04	0.01	37.00 [Hz]	Yes
20	Acceleration Time 1	Acc time-1	0 to 6000 [sec]	0.1	1.0 [sec]	Yes
21	Deceleration Time 1	Dec time-1	0 to 6000 [sec]	0.1	1.0 [sec]	Yes
22	Acceleration Time 2	Acc time-2	0 to 6000 [sec]	0.1	2.0 [sec]	Yes
23	Deceleration Time 2	Dec time-2	0 to 6000 [sec]	0.1	2.0 [sec]	Yes
24	Acceleration Time 3	Acc time-3	0 to 6000 [sec]	0.1	3.0 [sec]	Yes
25	Deceleration Time 3	Dec time-3	0 to 6000 [sec]	0.1	3.0 [sec]	Yes
26	Acceleration Time 4	Acc time-4	0 to 6000 [sec]	0.1	4.0 [sec]	Yes
27	Deceleration Time 4	Dec time-4	0 to 6000 [sec]	0.1	4.0 [sec]	Yes
28	Acceleration Time 5	Acc time-5	0 to 6000 [sec]	0.1	5.0 [sec]	Yes
29	Deceleration Time 5	Dec time-5	0 to 6000 [sec]	0.1	5.0 [sec]	Yes
30	Acceleration Time 6	Acc time-6	0 to 6000 [sec]	0.1	6.0 [sec]	Yes
31	Deceleration Time 6	Dec time-6	0 to 6000 [sec]	0.1	6.0 [sec]	Yes
32	Acceleration Time 7	Acc time-7	0 to 6000 [sec]	0.1	7.0 [sec]	Yes
33	Deceleration Time 7	Dec time-7	0 to 6000 [sec]	0.1	7.0 [sec]	Yes
34	Output Voltage / Current Meter (LM Meter) Selection	Analog meter	Voltage,Current	-	Voltage	Yes
35	Output Voltage / Current Meter (LM Meter) Adjustment (15V Pulse)	Analog adj.	0 to 120 [%]	1	100 [%]	Yes
36	FM Meter Output Adjustment (15V Pulse)	FM adj.	0 to 120 [%]	1	100 [%]	Yes
37	IO Meter Output Adjustment (4 to 20mA)	DAC adj.	0 to 120 [%]	1	100 [%]	Yes
38	Frequency Steady Level	FST-freq.	0 to FUN 04	0.1	0.50 [Hz]	No
39	Frequency Detection Level	FDT-freq.	0 to FUN 04	0.1	60.00 [Hz]	No
40	Frequency Detection Bandwidth	FDT-band	0 to 30 [Hz]	0.1	1.00 [Hz]	No
41	Multiplier Constant for Speed Display in 'DRV 04'	Mul. Factor	0 to 999	1	100	Yes
42	Divider Constant for Speed Display in 'DRV 04'	Div. factor	1 to 999	1	100	Yes
43	Status of Input Terminals	Ter. Input	-	-	-	-
44	Status of Output Terminals	Ter. Output	-	-	-	-
45	Software Version	SW version	-	-	2.00	-
46	Fault History 1	Last fault 1	Fault Status, Freq. at Fault, Current at Fault	-	-	Yes
47	Fault History 2	Last fault 2		-	-	Yes
48	Option 1 Selection	Option 1	None,RS485,ModBus RTU,FNet	-	None	No
49	Option 2 Selection	Option 2	None, MMC	-	None	No
50 ^{*13)}	Drive number for Option	Inv. Number	1 to 32	1	1	Yes
51	Baud rate for Option	Baud-rate	1200,2400,4800,9600,19200	-	9600 BPS	Yes
52	Communication Timeout	Comm. Timeout	0 to 60 [sec]	0.1	10.0 [Sec]	Yes
53	PG Slip Frequency for PG Option	PG Slip Freq	0 to 10 [Hz]	0.01	5.00 [Hz]	Yes
54	PG-P Gain for PG Option	PG. P-Gain	0 to 225	1	1	Yes
55	PG-I Gain for PG Option	PG. I-Gain	0 to 225	1	1	Yes
56	PG-Filter Gain for PG Option	PG. F-Gain	0 to 225	1	100	Yes
57	Encoder Selection for PG Option	Enc pulse	100,500,512,1000,1024,2000,2048,4000	-	512 Pulse	Yes
58	Digital Input for DI/DA Option	DI Mode	None,Freq. 1,Freq. 2	-	Freq. 1	Yes
59	Analog Output for DI/DA Option	DA Mode	Freq.,Voltage,Current	-	Freq.	Yes
60	Analog Output Adjustment	DA adj.	80 to 120 [%]	1	100 [%]	Yes
61	Drive Number for FNet	FN:St. ID	1 to 63	1	1	No

*13) Operation related parameters(FUN50 ~ FUN61) - Please refer to specific option manual.

Dimension(mm)

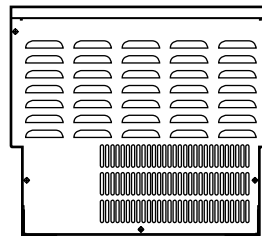
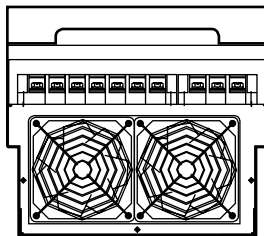
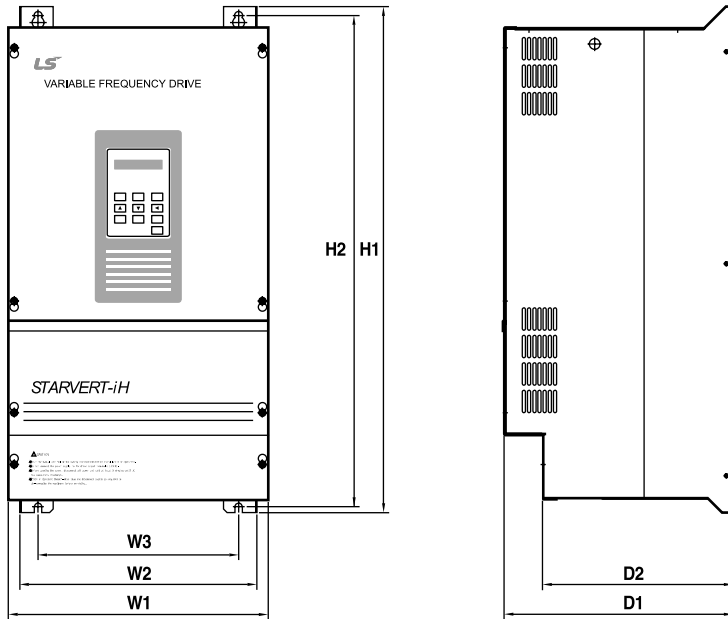

(unit : mm)

Class	Type	W1	W2	W3	H1	H2	D1	D2
200-230V	SV030iH-2	375	360	275	615	593.5	277.5	230.5
	SV037iH-2	375	360	275	615	593.5	277.5	230.5
	SV045iH-2	375	360	275	780	758.5	300.7	230.5
	SV055iH-2	375	360	275	780	758.5	300.7	230.5
380-460V	SV030iH-4	350	319.2	270	680	662	308.2	256.6
	SV037iH-4	350	319.2	270	680	662	308.2	256.6
	SV045iH-4	375	359.6	275	780	760.5	326	259
	SV055iH-4	375	359.6	275	780	760.5	326	259
	SV075iH-4	375	359.6	275	780	760.5	326	259
	SV090iH-4	530	507	430	780	762	335	286.2
	SV110iH-4	530	507	430	790	762	335	286.2
	SV132iH-4	530	507	430	1000	982	345	298
	SV160iH-4	530	507	430	1000	982	345	298
	SV220iH-4	680	649	540	998	968.5	403	343

Braking unit

Model name		SV037DBH-2	SV037DBH-4	SV075DBH-4
Max. DC Input Voltage		DC 400V (200V class)	DC 800V (400V class)	
Capacity		37kW / 200V	37kW / 400V	75kW / 400V
Required resistor		5kW 3Ω	5kW 12Ω	10kW 6Ω
Applicable type & braking resistor combination	SV030iH-2	1 unit (1x5kW 3Ω)		
	SV037iH-2	1 unit (1x5kW 3Ω)		
	SV045iH-2	Parallel 2 units (2x5kW 3Ω)		
	SV055iH-2	Parallel 2 units (2x5kW 3Ω)		
	SV030iH-4		1 unit (1x5kW 12Ω)	
	SV037iH-4		1 unit (1x5kW 12Ω)	
	SV045iH-4			1 unit (2x5kW 12Ω)
	SV055iH-4			1 unit (2x5kW 12Ω)
	SV075iH-4			1 unit (2x5kW 12Ω)
	SV090iH-4			Parallel 2 units (4x5kW 12Ω)
	SV110iH-4			Parallel 2 units (4x5kW 12Ω)
SV132iH-4			Parallel 2 units (4x5kW 12Ω)	
SV160iH-4			Parallel 2 units (4x5kW 12Ω)	
SV220iH-4			Parallel 2 units (4x5kW 12Ω)	
Braking torque 150%		150%		
Enable duty 5% ED		5% ED		
Output signal		Fault output contact, Slave control signal		
Protection		Heat sink overheat, Inverter Overheat		

RS-485 / Modbus-RTU

Category	Item	Specifications
Performance	Communication method	RS485
	Transmission form	Multi-drop Link System
	Applicable type	iH series
	Computer	PC or FA computer (needs RS232-485 converter)
	Number of drives	Maximum 32 drives connectable
	Transmission distance	Max. 1200m
Hardware	Installation	On control PCB inside the drives
	Power Supply	Control 5V DC from drive main PCB
	Communication	5V DC. Max.100mA (contained in Communication card)
Communication	Communication speed	19200/9600/4800/2400/1200 bps selectable
	Control procedure	Asynchronous communication system
	Communication system	Half duplex system
	Character system	RS485 : ASCII (8 bit) / ModBus-RTU : Binary
	Stop bit length	1 bit
	Sum check	2 bytes
	Parity check	None

F-net

Item	Specifications
Communication speed	1M bps
Communication type	Manchester Biphase-L, Frame Synchronous type
Cable	Twisted Pair Shielded Cable Name : LIREC-AMESB 1φ(PC 717 6705) Manufacturer : LS Cable
No. of node	Max. 64 per line
Distance	Max. 750m
Frame Format	FieldBus (IEC TC65/SC65C/WG6 65C 90.8)

Driveview 2.0

- Versatile, Easy-to-Use Software for LS Drives
- Provides Intuitive Means for Monitoring, Control and Commissioning of Drives
- Runs on RS-232/485 Serial Network Connection
- Designed for Microsoft Windows® 95 or later

Keypad Emulator

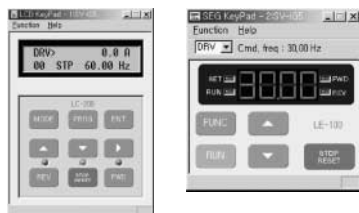

Graphic Monitor

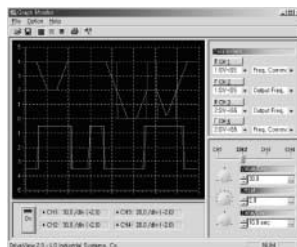

Parameter Editor

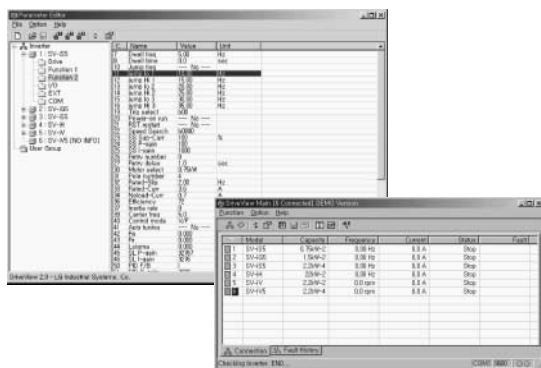

Text monitor



Peripheral devices

Type	kW	Breaker	Magnetic contactor	Power terminal wire(mm ²)	Earth Line (mm ²)	DC reactor	AC reactor	Fuse
SV030iH-2	30	ABS203/225	GMC-150	60	22	0.35mH, 152.0A	0.08mH, 134.2A	150A
SV037iH-2	37	ABS203/225	GMC-180	60	22	0.30mH, 180.0A	0.07mH, 160.6A	200A
SV045iH-2	45	ABS403/300	GMC-220	100	38	0.28mH, 221.0A	0.06mH, 198.0A	250A
SV055iH-2	55	ABS403/350	GMC-300	100	38	0.25mH, 270.0A	0.05mH, 242.0A	300A
SV030iH-4	30	ABS203/125	GMC-85	22	14	1.19mH, 76.0A	0.33mH, 67.1A	100A
SV037iH-4	37	ABS203/150	GMC-100	22	14	0.98mH, 93.0A	0.27mH, 82.5A	100A
SV045iH-4	45	ABS203/175	GMC-125	38	22	0.89mH, 112.0A	0.22mH, 100.1A	100A
SV055iH-4	55	ABS203/225	GMC-150	38	22	0.75mH, 135.0A	0.18mH, 121.0A	150A
SV075iH-4	75	ABS203/225	GMC-180	60	22	0.44mH, 187.0A	0.13mH, 167.2A	200A
SV090iH-4	90	ABS203/300	GMC-220	60	38	0.35mH, 225.0A	0.11mH, 201.3A	250A
SV110iH-4	110	ABS403/300	GMC-300	80	38	0.30mH, 274.0A	0.09mH, 245.3A	300A
SV132iH-4	132	ABS403/400	GMC-400	100	38	0.26mH, 324.0A	0.08mH, 290.4A	300A
SV160iH-4	160	ABS603/500	GMC-400	100	60	0.22mH, 399.0A	0.06mH, 357.5A	400A
SV220iH-4	220	ABS603/600	GMC-600	100x2	60			500A

RFI Filter

IH Series			Standard Filter										
type	Power	Code	Current	Voltage	Leakage Current	Dimensions			Mounting		Weight	Mount	Output Chokes
						L	W	H	Y	X			
THREE PHASE					Nom. MAX.								
SV030iH-2	30kW	FE-T150-2	150A	250VAC	1.3A 150A	480	200	160	468	166		-	FS-3
SV037iH-2	37kW	FE-T170-2	170A	250VAC	1.3A 150A	480	200	160	468	166		-	FS-3
SV045iH-2	45kW	FE-T230-2	230A	250VAC	1.3A 150A	580	250	205	560	170		-	FS-4
SV055iH-2	55kW	FE-T280-2	280A	250VAC	1.3A 150A	580	250	205	560	170		-	FS-4
SV030iH-4	30kW	FE-T070-2	70A	380VAC	1.3A 150A	350	180	90	338	146		-	FS-3
SV037iH-4	37kW	FE-T100-2	100A	380VAC	1.3A 150A	425	200	130	408	166		-	FS-3
SV045iH-4	45kW	FE-T120-2	120A	380VAC	1.3A 150A	425	200	130	408	166		-	FS-3
SV055iH-4	55kW												
SV075iH-4	75kW	FE-T170-2	170A	380VAC	1.3A 150A	480	200	160	468	166		-	FS-3
SV090iH-4	90kW	FE-T230-2	230A	380VAC	1.3A 150A	580	250	205	560	170		-	FS-4
SV110iH-4	110kW												
SV132iH-4	132kW	FE-T280-2	280A	380VAC	1.3A 150A	580	250	205	560	170		-	FS-4
SV160iH-4	160kW	FE-T400-2	400A	380VAC	1.3A 150A	700	370	250	640	300		-	FS-4
SV220iH-4	220kW	FE-T480-2	480A	380VAC	1.3A 150A	700	370	250	640	300		-	FS-4

FF Series (Footprint)

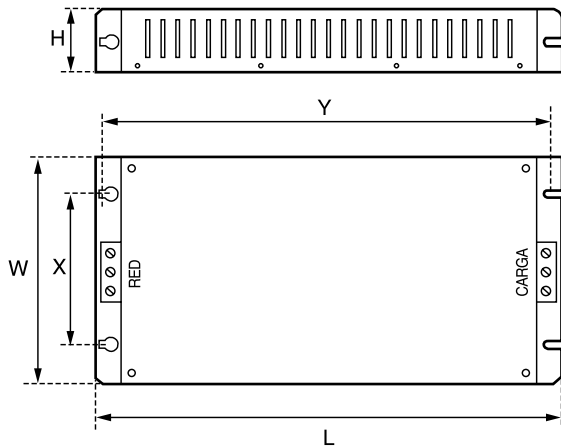

FE Series (Standard)

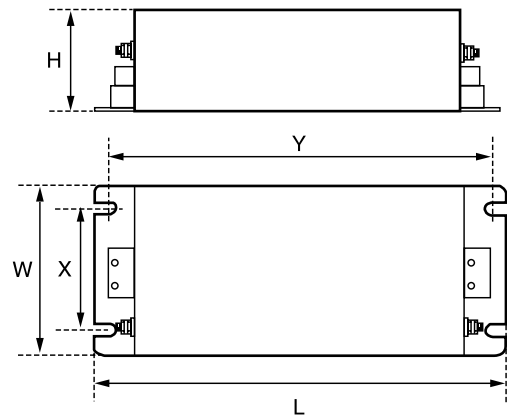

FS Series (output chokes)

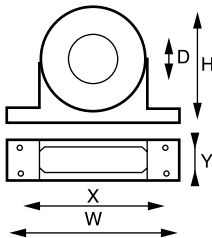

Type	D	W	H	X	O
FS-1	21	85	46	7-	5
FS-2	28.5	105	62	90	5
FS-3	48	150	110	125 x 30	5
FS-4	58	200	170	180 x 45	5



Safety Instructions

- For your safety, please read user's manual thoroughly before operating.
- Contact the nearest authorized service facility for examination, repair, or adjustment.
- Please contact qualified service technician when you need maintenance. Do not disassemble or repair by yourself!
- Any maintenance and inspection shall be performed by the personnel having expertise concerned.

2002.4 LS Industrial Systems Co.,Ltd. All rights reserved.

LS Industrial Systems Co., Ltd.

www.lgis.com

HEAD OFFICE

LS Tower 1026-6, Hogye-dong, Dongan-gu,
Anyang-si, Gyeonggi-do 431-848, Korea

Europe	+82-2-2034-4376 / ywsohn@lsgis.biz
Middle East	+82-2-2034-4901 / bonseongk@lsgis.biz
South West Asia	+82-2-2034-4645 / sungkyup@lsgis.biz
South East Asia	+82-2-2034-4707 / ohpark@lsgis.biz
CIS	+82-2-2034-4913 / jinhkang@lsgis.biz
America	+82-2-2034-4377 / yoonsupl@lsgis.biz

Global Network

- **LS Industrial Systems (Middle East) FZE Dubai, U.A.E.**
Address: LOB 19 JAFZA VIEW TOWER Room 205, Jebel Ali Freezone P.O. Box 114216, Dubai, United Arab Emirates
Tel: 971-4-886 5360 Fax: 971-4-886-5361 e-mail: hwym@lsgis.biz
- **Dalian LS Industrial Systems Co., Ltd. Dalian, China**
Address: No.15, Liaohexi 3-Road, Economic and Technical Development zone, Dalian 116600, China
Tel: 86-411-8273-7777 Fax: 86-411-8730-7560 e-mail: lixk@lsgis.com.cn
- **LS Industrial Systems (Wuxi) Co., Ltd. Wuxi, China**
Address: 102-A, National High & New Tech Industrial Development Area, Wuxi, Jiangsu, 214028, P.R.China
Tel: 86-510-8534-6666 Fax: 86-510-522-4078 e-mail: xuhg@lsgis.com.cn
- **LS-VINA Industrial Systems Co., Ltd. Hanoi, Vietnam**
Address: Nguyen Khe - Dong Anh - Ha Noi - Viet Nam
Tel: 84-4-882-0222 Fax: 84-4-882-0220 e-mail: srjo@lsgisvina.com
- **LS-VINA Industrial Systems Co., Ltd. Hochiminh, Vietnam**
Address: 41 Nguyen Thi Minh Khai Str. Yoco Bldg 4th Floor, Hochiminh City, Vietnam
Tel: 84-8-3822-7941 Fax: 84-8-3822-7942 e-mail: sbpark@lsgisvina.com
- **LS Industrial Systems Tokyo Office Tokyo, Japan**
Address: 16FL, Higashi-Kan, Akasaka Twin Tower 17-22, 2-chome, Akasaka, Minato-ku Tokyo 107-8470, Japan
Tel: 81-3-3582-9128 Fax: 81-3-3582-2667 e-mail: jschuna@lsgis.biz
- **LS Industrial Systems Shanghai Office Shanghai, China**
Address: Room E-G, 12th Floor Huamin Empire Plaza, No.726, West Yan'an Road Shanghai 200050, P.R. China
Tel: 86-21-5237-9977 (609) Fax: 89-21-5237-7191 e-mail: jinhk@lsgis.com.cn
- **LS Industrial Systems Beijing Office Beijing, China**
Address: B-Tower 17FL Beijing Global Trade Center B/D. No.36, BeiSanHuanDong-Lu, DongCheng-District, Beijing 100013, P.R. China
Tel: 86-10-5825-6025,7 Fax: 86-10-5825-6026 e-mail: cuixiaorong@lsgis.com.cn
- **LS Industrial Systems Guangzhou Office Guangzhou, China**
Address: Room 1403,14F, New Poly Tower, 2 Zhongshan Liu Road, Guangzhou, P.R. China
Tel: 86-20-8326-6764 Fax: 86-20-8326-6287 e-mail: linsz@lsgis.biz
- **LS Industrial Systems Chengdu Office Chengdu, China**
Address: 12Floor, Guodong Building, No52 Jindun Road Chengdu, 610041, P.R. China
Tel: 86-28-8612-9151 Fax: 86-28-8612-9236 e-mail: yangcf@lsgis.com.cn
- **LS Industrial Systems Qingdao Office Qingdao, China**
Address: 7B40, Haixin Guangchang Shenye Building B, No.9, Shandong Road Qingdao 26600, P.R. China
Tel: 86-532-8501-6568 Fax: 86-532-583-3793 e-mail: liqj@lsgis.com.cn

Specifications in this catalog are subject to change without notice due to continuous product development and improvement.